



Agilent X-Series Wireless Communications Test Set

This manual provides documentation
for the following test sets:

EXT Test Set E6607A/B/C

**U9080A LTE (FDD)
Measurement Application
User's and Programmer's
Reference**

Notices

© Agilent Technologies, Inc.
2010-2013

No part of this manual may be reproduced in any form or by any means (including electronic storage and retrieval or translation into a foreign language) without prior agreement and written consent from Agilent Technologies, Inc. as governed by United States and international copyright laws.

Trademark Acknowledgements

Microsoft® is a U.S. registered trademark of Microsoft Corporation.

Windows® and MS Windows® are U.S. registered trademarks of Microsoft Corporation.

Adobe Acrobat® and Reader® are U.S. registered trademarks of Adobe Systems Incorporated.

Java™ is a U.S. trademark of Sun Microsystems, Inc.

MATLAB® is a U.S. registered trademark of Math Works, Inc.

Norton Ghost™ is a U.S. trademark of Symantec Corporation.

Wikipedia® is a registered trademark of the Wikimedia Foundation.

Manual Part Number

U9080-90008

Supersedes: U9080-90004 and U9080-90006

Print Date

February 2013

Supersedes: N/A

Printed in USA

Agilent Technologies Inc.
1400 Fountaingrove Parkway
Santa Rosa, CA 95403

Warranty

The material contained in this document is provided “as is,” and is subject to being changed, without notice, in future editions. Further, to the maximum extent permitted by applicable law, Agilent disclaims all warranties, either express or implied, with regard to this manual and any information contained herein, including but not limited to the implied warranties of merchantability and fitness for a particular purpose. Agilent shall not be liable for errors or for incidental or consequential damages in connection with the furnishing, use, or performance of this document or of any information contained herein. Should Agilent and the user have a separate written agreement with warranty terms covering the material in this document that conflict with these terms, the warranty terms in the separate agreement shall control.

Technology Licenses

The hardware and/or software described in this document are furnished under a license and may be used or copied only in accordance with the terms of such license.

Restricted Rights Legend

If software is for use in the performance of a U.S. Government

prime contract or subcontract, Software is delivered and licensed as “Commercial computer software” as defined in DFAR 252.227-7014 (June 1995), or as a “commercial item” as defined in FAR 2.101(a) or as “Restricted computer software” as defined in FAR 52.227-19 (June 1987) or any equivalent agency regulation or contract clause. Use, duplication or disclosure of Software is subject to Agilent Technologies’ standard commercial license terms, and non-DOD Departments and Agencies of the U.S. Government will receive no greater than Restricted Rights as defined in FAR 52.227-19(c)(1-2) (June 1987). U.S. Government users will receive no greater than Limited Rights as defined in FAR 52.227-14 (June 1987) or DFAR 252.227-7015 (b)(2) (November 1995), as applicable in any technical data.

Safety Notices

CAUTION

A **CAUTION** notice denotes a hazard. It calls attention to an operating procedure, practice, or the like that, if not correctly performed or adhered to, could result in damage to the product or loss of important data. Do not proceed beyond a CAUTION notice until the indicated conditions are fully understood and met.

WARNING

A **WARNING** notice denotes a hazard. It calls attention to an operating procedure, practice, or the like that, if not correctly performed or adhered to, could result in personal injury or death. Do not proceed beyond a WARNING notice until the indicated conditions are fully understood and met.

Warranty

This Agilent technologies instrument product is warranted against defects in material and workmanship for a period of one year from the date of shipment. During the warranty period, Agilent Technologies will, at its option, either repair or replace products that prove to be defective.

For warranty service or repair, this product must be returned to a service facility designated by Agilent Technologies. Buyer shall prepay shipping charges to Agilent Technologies, and Agilent Technologies shall pay shipping charges to return the product to Buyer. For products returned to Agilent Technologies from another country, Buyer shall pay all shipping charges, duties, and taxes.

Where to Find the Latest Information

Documentation is updated periodically. For the latest information about these products, including instrument software upgrades, application information, and product information, browse to one of the following URLs, according to the name of your product:

<http://www.agilent.com/find/ext>

To receive the latest updates by email, subscribe to Agilent Email Updates at the following URL:

<http://www.agilent.com/find/emailupdates>

Information on preventing test set damage can be found at:

<http://www.agilent.com/find/tips>

Is your product software up-to-date?

Periodically, Agilent releases software updates to fix known defects and incorporate product enhancements. To search for software updates for your product, go to the Agilent Technical Support website at:

<http://www.agilent.com/find/techsupport>

1. Using Help

How Help is Organized.....	116
Front Panel Keys used by the Help System	119
Navigating the Help Files	121
Basic Help Window Operations	122
Navigating Help with a Mouse	123
Navigating Help Without a Mouse	124
Definition of Terms.....	129
Viewing Help Files on a separate Computer.....	131
Other Help Resources	133
Context Sensitive Help not Available.....	135

2. About the Test Set

How the Test Set Is Used	138
Receiver Testing	138
Transmitter Testing	138
Hardware Elements of the Test Set.....	139
Software Elements of the Test Set.....	144
Methods of Operating the Source	147
Waveform Segment Files	147
Methods of Operating the Analyzer	147
Creating Sequences.....	147
Executing Sequences.....	148
Installing Application Software	149
Viewing a license key	149
Obtaining and installing a license key	149
Missing and old Measurement application software.....	150
X-Series options and accessories	151
Front-Panel Features (E6607A/B)	152
Overview of key types.....	154
Front-Panel Features (E6607C)	159
Overview of key types	161
Display Annotations	165
Test Set Display Indicators	167
Rear-Panel Features	168
Window Control Keys	170
Multi-Window.....	170
Zoom.....	170
Next Window	171
Mouse and Keyboard Control.....	173
Right-Click	173
Virtual Front Panel	175
PC Keyboard.....	176
Instrument Security & Memory Volatility	180

3. About the U9080A LTE Measurement Application

What Does the Agilent U9080A LTE Measurement Application Do?.....	182
---	-----

4. Programming the Test Set

What Programming Information is Available?	184
IEEE Common GPIB Commands	185
Calibration Query	185
Clear Status	185
Standard Event Status Enable	185
Standard Event Status Register Query	186
Identification Query	186
Instrument Model Number	187
Operation Complete	187
Query Instrument Options	188
Recall Instrument State	188
Save Instrument State	189
Service Request Enable	189
Status Byte Query	190
Trigger	190
Self Test Query	190
Wait-to-Continue	191

5. System Functions

File	194
File Explorer	194
Page Setup	195
Print	196
Maximize/Restore Down	196
Minimize	197
Exit	197
Mode Preset	198
Restore Mode Defaults	200
Meas Preset	201
Preset Type (Remote Command Only)	201
*RST (Remote Command Only)	202
Print	203
Quick Save	204
Recall	206
State	207
Trace (+State)	212
Sequences	215
Data (Import)	217
Save	219
State	219
Trace (+State)	224
Sequences	226
Data (Export)	228
Screen Image	230
Mass Storage Catalog (Remote Command Only)	234
Mass Storage Change Directory (Remote Command Only)	234
Mass Storage Copy (Remote Command Only)	234
Mass Storage Delete (Remote Command Only)	235

Mass Storage Data (Remote Command Only)	235
Mass Storage Make Directory (Remote Command Only)	236
Mass Storage Move (Remote Command Only)	236
Mass Storage Remove Directory (Remote Command Only)	236
System.	238
Show	238
Power On.	245
Alignments	255
I/O Config	297
Restore Defaults	306
Control Panel.	311
Licensing.	311
Security	314
Diagnostics	314
Service.	326
Internet Explorer.	326
System Remote Commands (Remote Commands Only)	326
User Preset	330
User Preset.	330
User Preset All Modes.	331
Save User Preset	332

6. Channel Power Measurement

AMPTD Y Scale	336
Ref Value	336
Attenuation	337
Scale/Div	337
Y Axis Unit.	338
Internal Preamp	338
Ref Position	338
Auto Scaling	339
Auto Couple	340
BW	341
Res BW	341
Video BW	342
Filter Type	343
Cont.	345
FREQ Channel	346
Input/Output	347
Marker.	348
Select Marker	348
Marker Type	348
Marker X Axis Value (Remote Command Only)	349
Marker X Axis Position (Remote Command Only)	350
Marker Y Axis Value (Remote Command only)	350
Properties.	351
Couple Markers	352
All Markers Off.	352
Backward Compatibility SCPI Commands.	352

Contents

Marker Function	354
Marker To	355
Meas	356
Meas Setup	357
Avg/Hold Num	357
Avg Mode	358
Integ BW	359
PhNoise Opt	360
IF Gain	362
Method	363
Limits	366
PSD Unit	369
Meas Preset	370
Mode	371
Mode Setup	372
Peak Search	373
Recall	374
Restart	375
Save	376
Data	376
Single	380
Source (Internal)	381
Span X Scale	382
Span	382
Full Span	383
Last Span	384
Sweep/Control	385
Sweep Time	385
Sweep Setup	386
Pause	387
Gate	387
Points	387
Trace/Detector	389
Trace Type	389
Detector	390
Trigger	393
View/Display	394
Display	397
Bar Graph	397

7. Occupied Bandwidth Measurement

AMPTD Y Scale (Amplitude/Y Scale)	401
Ref Value	401
Attenuation	402
Scale/Div	402
Y Axis Unit	403
Internal Preamp	403
Ref Position	403
Auto Scaling	404

Contents

Auto Couple	405
BW	406
Res BW	406
Video BW	407
Filter Type	409
Cont (Continuous)	410
FREQ/Channel (Frequency or Channel)	411
Input/Output	412
Marker	413
Select Marker	413
Marker X Axis Value (Remote Command Only)	413
Marker X Axis Position (Remote Command Only)	414
Marker Y Axis Value (Remote Command Only)	414
Marker Type	415
Properties	416
All Markers Off	417
Backward Compatibility SCPI Commands	417
Marker Function	418
Marker To	419
Meas	420
Meas Setup	421
Avg/Hold Num	421
Avg Mode	422
Max Hold (Remote Command Only)	423
Occ BW % Pwr	423
x dB	424
IF Gain	425
Limit	426
Meas Preset	428
Mode	429
Mode Setup	430
Peak Search	431
Recall	432
Restart	433
Save	434
Data	434
Single	438
Source (Internal)	439
Span X Scale	440
Span	440
Full Span	441
Last Span	441
Sweep/Control	443
Sweep Time	443
Sweep Setup	444
Pause	445
Gate	445
Points	445
Trace/Detector	447

Contents

Trace Type	447
Detector	448
Trigger	451
View/Display	452
Display	455

8. ACP Measurement

AMPTD Y Scale	464
Ref Value	464
Attenuation	465
Scale/Div	465
Y Axis Unit	466
Internal Preamp	466
Ref Position	466
Auto Scaling	467
Auto Couple	468
BW	469
Res BW	469
Video BW	470
RBW Control	471
Cont	473
FREQ Channel	474
Input/Output	475
Marker	476
Select Marker	476
Marker Type	476
Marker X Axis Value (Remote Command Only)	477
Marker X Axis Position (Remote Command Only)	478
Marker Y Axis Value (Remote Command Only)	479
Properties	479
Couple Markers	481
Marker All Off	482
Backward Compatibility Remote Commands	482
Marker Function	483
Marker To	484
Meas	485
Meas Setup	486
Average/Hold Number	486
Avg Mode	487
Carrier Setup	487
Offset/Limits	498
Carrier Result	515
PhNoise Opt	516
Meas Method	517
Meas Type	519
Limit Test	520
Noise Correction	520
Meas Preset	521
Offset RRC Weighting (Backward Compatibility SCPI)	523

Offset Filter Alpha (Backward Compatibility SCPI)	523
Method for Carrier (Backward Compatibility SCPI)	524
Mode	526
Mode Setup	527
Peak Search	528
Peak Search	528
Next Peak	528
Next Pk Right	528
Next Pk Left	529
Marker Delta	529
Pk-Pk Search	529
Min Search	530
Recall	531
Restart	532
Save	533
Single	534
Source (Internal)	535
SPAN X Scale	536
Span	536
Full Span	537
Last Span	537
Sweep/Control	538
Sweep Time	538
Sweep Setup	539
Pause	540
Gate	540
Points	541
Trace/Detector	542
Select Trace (Front-panel Only)	542
Trace Type	542
View / Blank	544
Detector	545
Trigger	548
View/Display	549
Display	551
Bar Graph	551

9. Spectrum Emission Mask Measurement

AMPTD Y Scale	571
Ref Value	571
Attenuation	572
Scale/Div	572
Y Axis Unit	573
Ref Position	573
Auto Scaling	573
Auto Couple	575
BW	576
Filter Type	576
Cont.	577

Contents

FREQ Channel	578
Input/Output	579
Marker	580
Select Marker	580
Marker Type	580
Marker X Axis Value (Remote Command Only)	581
Marker X Axis Position (Remote Command Only)	582
Marker Y Axis Value (Remote Command Only)	583
Couple Markers	583
All Markers Off	584
Marker Function	585
Marker To	586
Meas	587
Meas Setup	588
Avg/Hold Num	588
Meas Type	589
Ref Channel	589
Offset/Limits	599
Method	624
Filter Alpha	624
Meas Preset	625
Limit State(Only for TD-SCDMA)	625
80+80 MHz Mask (Only for WLAN)	626
Mode	627
Mode Setup	627
Peak Search	627
Recall	628
Restart	628
Save	628
Single	640
Source (Internal)	641
Span X Scale	642
Ref Value	642
Scale/Div	643
Ref Position	643
Auto Scaling	644
Sweep/Control	644
Trace/Detector	646
Trace Type	646
Chan Detector	647
Offset Detector	648
Trigger	651
View/Display	652
Display	653
Abs Pwr Freq	655
Rel Pwr Freq	662
Integrated Power	669
Limit Lines	677

10. Transmit On/Off Power Measurement

Amplitude (AMPTD) Y Scale	684
Ref Value (Burst View)	684
Ref Value (Rise & Fall view)	684
Attenuation	685
Scale/Div(Burst View)	685
Scale/Div (Rise & Fall view)	686
Internal Preamp	687
Ref Position(Burst View)	687
Ref Position (Rise & Fall view)	687
Auto Scale(Burst View)	688
Auto Scale (Rise & Fall view)	689
Auto Couple	690
BW	691
Cont.	693
FREQ Channel	694
Input/Output	695
Marker	696
Select Marker	696
Marker Type	696
Marker X Axis Value.	697
Marker X Axis Position (Remote Command only).	698
Marker Y Axis Value (Remote Command only).	698
Properties.	699
Couple Marker.	700
All Markers Off.	701
Maker State (Remote Command Only).	701
Marker Fctn.	703
Marker To	704
Meas	705
Meas Setup	706
Avg/Hold Num	706
Avg Mode	706
Avg Type	707
Ramp Time Length	708
IF Gain.	708
Limits	710
Threshold.	713
Noise Correction	715
Meas Preset	715
Predefined Parameters	715
Mode	718
Mode Setup	719
Peak Search.	720
Recall	721
Restart.	722
Save.	723
Single	724
Source (Internal)	725

SPAN X Scale	726
Ref Value(Burst View)	726
Ref Value(Rise & Fall view)	726
Scale/Div(Burst View)	727
Scale/Div(Rise & Fall View)	728
Ref Position(Burst View)	728
Ref Position(Rise & Fall View)	729
Auto Scale(Burst View)	729
Auto Scale(Rise & Fall View)	730
Sweep/Control	731
Abort (Remote Command Only)	731
Pause and Resume	731
Trace/Detector	732
Max Hold Trace	732
Min Hold Trace	732
Trigger	734
Trigger Source	734
Auto Trig	734
Trig Holdoff	734
View/Display	735
Display	736
Burst View	736
Rise & Fall View	742
Ramp Lines	743
Scroll	744

11. LTE Modulation Analysis Measurement

AMPTD (Amplitude) Y Scale	753
Auto Couple	754
BW (Bandwidth)	755
Cont (Continuous)	756
FREQ Channel	757
Center Freq	757
Start Freq	757
Stop Freq	758
CF Step	758
Input/Output	759
Marker	760
Marker Function	761
Marker -> (Marker To)	762
Meas (Measure)	763
Meas Setup (Measurement Setup)	764
Avg Number	764
Average Mode	765
Average Setup	765
Sync/Format Setup (Downlink)	765
Sync/Format Setup (Uplink)	780
Meas Time Setup	784
Chan Profile Setup (Downlink)	789

Chan Profile Setup (Uplink)	920
Decode	1080
Advanced	1102
Meas Preset	1130
Mode	1131
Mode Setup	1132
Peak Search	1133
Recall	1134
Restart	1135
Save	1136
Single	1137
Source (Internal)	1138
SPAN X Scale	1139
Span	1139
Full Span	1139
Sweep / Control	1140
Trace/Detector	1141
Data	1141
Trigger	1170
View/Display	1171
Display	1171
Layout	1171
Preset View	1172

12. Conformance EVM

Amplitude (AMPTD) Y Scale	1183
Attenuation	1183
Internal Preamp	1183
Auto Couple	1184
BW	1185
Info BW	1185
Cont (Continuous)	1187
FREQ Channel	1188
Center Freq	1188
CF Step	1188
Input/Output	1189
Marker	1190
Marker Fctn	1191
Marker > (Marker To)	1192
Meas	1193
Meas Setup	1194
Meas Method (when 85 MHz or wider analysis bandwidth option is installed)	1194
Copy from Mod Analysis Measurement	1196
Meas Preset	1197
Result Values	1197
Mode	1201
Mode Setup	1202
Peak Search	1203
Recall	1204

Restart	1205
Save	1206
Single	1207
Source (Internal)	1208
SPAN X Scale	1209
Sweep/Control	1210
Trace/Detector	1211
Trigger	1212
View/Display	1213
Display	1213
Measurement List view	1213
Parameter List view	1214
Result Metrics view	1215
RF Envelope view	1216

13. Common Measurement Functions

Common Measurement Functions 1	1221
AMPTD Y Scale	1221
Auto Couple	1259
BW	1260
Cont (Continuous Measurement/Sweep)	1271
FREQ Channel	1272
Input/Output	1281
Marker	1353
Marker Function	1372
Marker To	1391
Meas	1395
Meas Setup	1409
Mode	1453
Mode Setup	1466
Peak Search	1470
Recall	1484
Restart	1488
Save	1490
Single (Single Measurement/Sweep)	1497
Source (Internal)	1497
Span	1634
Sweep/Control	1638
Trace/Detector	1665
Trigger	1704
View/Display	1748
Common Measurement Functions 2	1759
AMPTD Y Scale (Amplitude)	1759
BW (Bandwidth)	1766
FREQ Channel	1770
Marker	1773
Marker -> (Marker To)	1789
Marker Function	1792
Meas Setup	1800

Peak Search	1807
Recall	1811
Save	1815
SPAN X Scale	1818
Sweep/Control	1826
Trace/Detector	1831
Trigger	1874
View/Display	1890
Remote SCPI Commands and Data Queries	1894

List of Commands

This list includes every SCPI command described in this document. To find a command in the list, search according to its first alphanumeric character, ignoring any leading "*", ":" or "[" characters.

:ABORt.	1664
*CAL?	264
:CALC:EVM:DATA4:TABL:STR? "FreqErr"	747
:CALCulate:<meas>:DATA[1] 2 3 4? [Y X XY[,OFF ON 0 1] LL UL].	1899
:CALCulate:<meas>:DATA[1] 2 3 4:HEADer:NAMes?	1906
:CALCulate:<meas>:DATA[1] 2 3 4:HEADer[:NUMBer]? <string>	1908
:CALCulate:<meas>:DATA[1] 2 3 4:HEADer:STRing? <string>	1907
:CALCulate:<meas>:DATA[1] 2 3 4:HEADer:TYPE? <string>	1907
:CALCulate:<meas>:DATA[1] 2 3 4:NAMes?.	1833
:CALCulate:<meas>:DATA[1] 2 3 4:POINts? [OFF ON 0 1]	1901
:CALCulate:<meas>:DATA[1] 2 3 4:RAW?	1900
:CALCulate:<meas>:DATA[1] 2 3 4:RAW:COMPLex?	1900
:CALCulate:<meas>:DATA[1] 2 3 4:RAW:POINts?	1901
:CALCulate:<meas>:DATA[1] 2 3 4:TABL:NAMes?	1904
:CALCulate:<meas>:DATA[1] 2 3 4:TABL[:NUMBer]? [<string>].	1903
:CALCulate:<meas>:DATA[1] 2 3 4:TABL:STRing? [<string>].	1903
:CALCulate:<meas>:DATA[1] 2 3 4:TABL:UNIT?	1904
:CALCulate:<meas>:MARKer[1] 2 3 4 5 6 7 8 9 10 11 12:CFORmat RECTangular POLar	1785
:CALCulate:<meas>:MARKer[1] 2 3 4 5 6 7 8 9 10 11 12:CFORmat?	1785
:CALCulate:<meas>:MARKer[1] 2 3 4 5 6 7 8 9 10 11 12:CPSeArch[:STATe] ON OFF 1 0	1810
:CALCulate:<meas>:MARKer[1] 2 3 4 5 6 7 8 9 10 11 12:CPSeArch[:STATe]?	1810
:CALCulate:<meas>:MARKer[1] 2 3 4 5 6 7 8 9 10 11 12:FCOunt[:STATe] OFF ON 0 1	1787
:CALCulate:<meas>:MARKer[1] 2 3 4 5 6 7 8 9 10 11 12:FCOunt[:STATe]?	1787
:CALCulate:<meas>:MARKer[1] 2 3 4 5 6 7 8 9 10 11 12:FCOunt:X?	1787
:CALCulate:<meas>:MARKer[1] 2 3 4 5 6 7 8 9 10 11 12:FUNCTion BPOWer BDENsity =OFF	1793
:CALCulate:<meas>:MARKer[1] 2 3 4 5 6 7 8 9 10 11 12:FUNCTion?	1793

List of Commands

:CALCulate:<meas>:MARKer[1] 2 3 4 5 6 7 8 9 10 11 12:FUNction:BAND:CENTer <real>	1797
:CALCulate:<meas>:MARKer[1] 2 3 4 5 6 7 8 9 10 11 12:FUNction:BAND:CENTer?	1797
:CALCulate:<meas>:MARKer[1] 2 3 4 5 6 7 8 9 10 11 12:FUNction:BAND:LEFT <real>	1799
:CALCulate:<meas>:MARKer[1] 2 3 4 5 6 7 8 9 10 11 12:FUNction:BAND:LEFT?	1799
:CALCulate:<meas>:MARKer[1] 2 3 4 5 6 7 8 9 10 11 12:FUNction:BAND:RIghT <real>.....	1799
:CALCulate:<meas>:MARKer[1] 2 3 4 5 6 7 8 9 10 11 12:FUNction:BAND:RIghT?.	1799
:CALCulate:<meas>:MARKer[1] 2 3 4 5 6 7 8 9 10 11 12:FUNction:BAND:SPAN <real>	1798
:CALCulate:<meas>:MARKer[1] 2 3 4 5 6 7 8 9 10 11 12:FUNction:BAND:SPAN?	1798
:CALCulate:<meas>:MARKer[1] 2 3 4 5 6 7 8 9 10 11 12:FUNction:BDENsity:CTYPe MEAN RMS	1797
:CALCulate:<meas>:MARKer[1] 2 3 4 5 6 7 8 9 10 11 12:FUNction:BDENsity:CTYPe?	1797
:CALCulate:<meas>:MARKer[1] 2 3 4 5 6 7 8 9 10 11 12:FUNction:BPOWer:CTYPe MEAN RMS	1795
:CALCulate:<meas>:MARKer[1] 2 3 4 5 6 7 8 9 10 11 12:FUNction:BPOWer:CTYPe?	1795
:CALCulate:<meas>:MARKer[1] 2 3 4 5 6 7 8 9 10 11 12:MAXimum.....	1807
:CALCulate:<meas>:MARKer[1] 2 3 4 5 6 7 8 9 10 11 12:MAXimum:LEFT	1809
:CALCulate:<meas>:MARKer[1] 2 3 4 5 6 7 8 9 10 11 12:MAXimum:NEXt.....	1808
:CALCulate:<meas>:MARKer[1] 2 3 4 5 6 7 8 9 10 11 12:MAXimum:PREVious	1808
:CALCulate:<meas>:MARKer[1] 2 3 4 5 6 7 8 9 10 11 12:MAXimum:RIghT.....	1809
:CALCulate:<meas>:MARKer[1] 2 3 4 5 6 7 8 9 10 11 12:MINimum.....	1811
:CALCulate:<meas>:MARKer[1] 2 3 4 5 6 7 8 9 10 11 12:MODE POSition DELTA FIXed =OFF.....	1775
:CALCulate:<meas>:MARKer[1] 2 3 4 5 6 7 8 9 10 11 12:MODE?	1775
:CALCulate:<meas>:MARKer[1] 2 3 4 5 6 7 8 9 10 11 12:REFerence <integer>.....	1784
:CALCulate:<meas>:MARKer[1] 2 3 4 5 6 7 8 9 10 11 12:REFerence?	1784
:CALCulate:<meas>:MARKer[1] 2 3 4 5 6 7 8 9 10 11 12:TRACe <integer>.....	1786
:CALCulate:<meas>:MARKer[1] 2 3 4 5 6 7 8 9 10 11 12:TRACe?	1786
:CALCulate:<meas>:MARKer[1] 2 3 4 5 6 7 8 9 10 11 12:X <real>	1779
:CALCulate:<meas>:MARKer[1] 2 3 4 5 6 7 8 9 10 11 12:X?.....	1779
:CALCulate:<meas>:MARKer[1] 2 3 4 5 6 7 8 9 10 11 12[:X]:POSition <real>.....	1780
:CALCulate:<meas>:MARKer[1] 2 3 4 5 6 7 8 9 10 11 12[:X]:POSition?.....	1780
:CALCulate:<meas>:MARKer[1] 2 3 4 5 6 7 8 9 10 11 12:X:UNIT?	1780
:CALCulate:<meas>:MARKer[1] 2 3 4 5 6 7 8 9 10 11 12:Y:IMAGinary <real>	1782
:CALCulate:<meas>:MARKer[1] 2 3 4 5 6 7 8 9 10 11 12:Y:IMAGinary?	1782

List of Commands

:CALCulate:<meas>:MARKer[1] 2 3 4 5 6 7 8 9 10 11 12:Y[:REAL] <real>	1781
:CALCulate:<meas>:MARKer[1] 2 3 4 5 6 7 8 9 10 11 12:Y[:REAL]?	1781
:CALCulate:<meas>:MARKer[1] 2 3 4 5 6 7 8 9 10 11 12:Y:UNIT?	1782
:CALCulate:<meas>:MARKer[1] 2 3 4 5 6 7 8 9 10 11 12:Z <real>	1783
:CALCulate:<meas>:MARKer[1] 2 3 4 5 6 7 8 9 10 11 12:Z?	1783
:CALCulate:<meas>:MARKer[1] 2 3 4 5 6 7 8 9 10 11 12:Z:UNIT?	1784
:CALCulate:<meas>:MARKer:AOff	1789
:CALCulate:<meas>:MARKer:COUPle[:STATe] OFF ON 0 1	1789
:CALCulate:<meas>:MARKer:COUPle[:STATe]?	1789
:CALCulate:<meas>:MARKer:TABLE[:STATe] OFF ON 0 1	1788
:CALCulate:<meas>:MARKer:TABLE[:STATe]?	1788
:CALCulate:<meas>:TRACe[1] 2 3 4:ACPoweR:CARRier:BANDwidth BWIDTH:INTegration <bandwidth>	1863
:CALCulate:<meas>:TRACe[1] 2 3 4:ACPoweR:CARRier:BANDwidth BWIDTH:INTegration?	1863
:CALCulate:<meas>:TRACe[1] 2 3 4:ACPoweR:CARRier:FILTer:RRC:ALPHa <real>	1864
:CALCulate:<meas>:TRACe[1] 2 3 4:ACPoweR:CARRier:FILTer:RRC:ALPHa?	1864
:CALCulate:<meas>:TRACe[1] 2 3 4:ACPoweR:CARRier:FILTer:RRC:STATe OFF ON 0 1	1863
:CALCulate:<meas>:TRACe[1] 2 3 4:ACPoweR:CARRier:FILTer:RRC:STATe?	1863
:CALCulate:<meas>:TRACe[1] 2 3 4:ACPoweR:CARRier:FREQuency <freq>	1862
:CALCulate:<meas>:TRACe[1] 2 3 4:ACPoweR:CARRier:FREQuency?	1862
:CALCulate:<meas>:TRACe[1] 2 3 4:ACPoweR:OFFSet:FILTer:RRC:STATe OFF ON 0 1	1868
:CALCulate:<meas>:TRACe[1] 2 3 4:ACPoweR:OFFSet:FILTer:RRC:STATe?	1868
:CALCulate:<meas>:TRACe[1] 2 3 4:ACPoweR:OFFSet:LIST:BANDwidth BWIDTH:INTegration <bandwidth>,	1866
:CALCulate:<meas>:TRACe[1] 2 3 4:ACPoweR:OFFSet:LIST:BANDwidth BWIDTH:INTegration?	1866
:CALCulate:<meas>:TRACe[1] 2 3 4:ACPoweR:OFFSet:LIST:FILTer:RRC:ALPHa <real>,	1866
:CALCulate:<meas>:TRACe[1] 2 3 4:ACPoweR:OFFSet:LIST:FILTer:RRC:ALPHa?	1866
:CALCulate:<meas>:TRACe[1] 2 3 4:ACPoweR:OFFSet:LIST:FREQuency <freq>,	1865
:CALCulate:<meas>:TRACe[1] 2 3 4:ACPoweR:OFFSet:LIST:FREQuency?	1865
:CALCulate:<meas>:TRACe[1] 2 3 4:ACPoweR:OFFSet:LIST:RCARRier <real>,	1867
:CALCulate:<meas>:TRACe[1] 2 3 4:ACPoweR:OFFSet:LIST:RCARRier?	1867
:CALCulate:<meas>:TRACe[1] 2 3 4:ACPoweR:OFFSet:LIST:RCARRier:TEST OFF ON 0 1,	1867

List of Commands

:CALCulate:<meas>:TRACe[1] 2 3 4:ACPoweR:OFFSet:LIST:RCARrier:TEST?	1867
:CALCulate:<meas>:TRACe[1] 2 3 4:ACPoweR:OFFSet:LIST:STATe OFF ON 0 1,.....	1865
:CALCulate:<meas>:TRACe[1] 2 3 4:ACPoweR:OFFSet:LIST:STATe?	1865
:CALCulate:<meas>:TRACe[1] 2 3 4:ACPoweR:STATe OFF ON 0 1	1862
:CALCulate:<meas>:TRACe[1] 2 3 4:ACPoweR:STATe?	1862
:CALCulate:<meas>:TRACe[1] 2 3 4:LIMit:VISible OFF ON 0 1	1874
:CALCulate:<meas>:TRACe[1] 2 3 4:LIMit:VISible?	1874
:CALCulate:<meas>:TRACe[1] 2 3 4:OBWidth:CENTrOID?	1870
:CALCulate:<meas>:TRACe[1] 2 3 4:OBWidth:LIMit:FBLimit <freq>	1871
:CALCulate:<meas>:TRACe[1] 2 3 4:OBWidth:LIMit:FBLimit?	1871
:CALCulate:<meas>:TRACe[1] 2 3 4:OBWidth:LIMit[:TEST] OFF ON 0 1	1871
:CALCulate:<meas>:TRACe[1] 2 3 4:OBWidth:LIMit[:TEST]?	1871
:CALCulate:<meas>:TRACe[1] 2 3 4:OBWidth:PERCent <real>	1870
:CALCulate:<meas>:TRACe[1] 2 3 4:OBWidth:PERCent?	1870
:CALCulate:<meas>:TRACe[1] 2 3 4:OBWidth:STATe OFF ON 0 1	1870
:CALCulate:<meas>:TRACe[1] 2 3 4:OBWidth:STATe?	1870
:CALCulate:ACPoweR:LIMit:STATe OFF ON 0 1	520
:CALCulate:ACPoweR:LIMit:STATe?	520
:CALCulate:ACPoweR:MARKer[1] 2 3 4 5 6 7 8 9 10 11 12:MAXimum	528
:CALCulate:ACPoweR:MARKer[1] 2 3 4 5 6 7 8 9 10 11 12:MAXimum:LEFT	529
:CALCulate:ACPoweR:MARKer[1] 2 3 4 5 6 7 8 9 10 11 12:MAXimum:NEXT	528
:CALCulate:ACPoweR:MARKer[1] 2 3 4 5 6 7 8 9 10 11 12:MAXimum:RIGHT	529
:CALCulate:ACPoweR:MARKer[1] 2 3 4 5 6 7 8 9 10 11 12:MINimum	530
:CALCulate:ACPoweR:MARKer[1] 2 3 4 5 6 7 8 9 10 11 12:MODE POSition DELTA OFF	476
:CALCulate:ACPoweR:MARKer[1] 2 3 4 5 6 7 8 9 10 11 12:MODE?	476
:CALCulate:ACPoweR:MARKer[1] 2 3 4 5 6 7 8 9 10 11 12:PTPeak	530
:CALCulate:ACPoweR:MARKer[1] 2 3 4 5 6 7 8 9 10 11 12:REFerence <integer>	480
:CALCulate:ACPoweR:MARKer[1] 2 3 4 5 6 7 8 9 10 11 12:REFerence?	480
:CALCulate:ACPoweR:MARKer[1] 2 3 4 5 6 7 8 9 10 11 12:STATe OFF ON 0 1	482
:CALCulate:ACPoweR:MARKer[1] 2 3 4 5 6 7 8 9 10 11 12:STATe?	482
:CALCulate:ACPoweR:MARKer[1] 2 3 4 5 6 7 8 9 10 11 12:TRACe 1 2 3	480

List of Commands

:CALCulate:ACPower:MARKer[1] 2 3 4 5 6 7 8 9 10 11 12:TRACe?	480
:CALCulate:ACPower:MARKer[1] 2 3 4 5 6 7 8 9 10 11 12:X <freq>	477
:CALCulate:ACPower:MARKer[1] 2 3 4 5 6 7 8 9 10 11 12:X?	477
:CALCulate:ACPower:MARKer[1] 2 3 4 5 6 7 8 9 10 11 12:X:POSition <real>	478
:CALCulate:ACPower:MARKer[1] 2 3 4 5 6 7 8 9 10 11 12:X:POSition?	478
:CALCulate:ACPower:MARKer[1] 2 3 4 5 6 7 8 9 10 11 12:Y?	479
:CALCulate:ACPower:MARKer:AOff	482
:CALCulate:ACPower:MARKer:COUPle[:STATe] ON OFF 0 1	481
:CALCulate:ACPower:MARKer:COUPle[:STATe]?	481
:CALCulate:ACPower:OFFSet:LIST:LIMit:NEGative[:UPPer]:DATA <real>, <real>, <real>, <real>, <real>, <real>	510
:CALCulate:ACPower:OFFSet:LIST:LIMit:NEGative[:UPPer]:DATA?	510
:CALCulate:ACPower:OFFSet:LIST:LIMit:POSitive[:UPPer]:DATA <real>, <real>, <real>, <real>, <real>, <real>	509
:CALCulate:ACPower:OFFSet:LIST:LIMit:POSitive[:UPPer]:DATA?	509
:CALCulate:BWIDth BANDwidth:NDB <rel_ampl>	1435
:CALCulate:BWIDth BANDwidth:NDB?	1435
:CALCulate:BWIDth BANDwidth:RESult?	1436
:CALCulate:BWIDth BANDwidth[:STATe] OFF ON 0 1	1435
:CALCulate:BWIDth BANDwidth[:STATe]?	1435
:CALCulate:CHPower:LIMit:POWer <ampl>	366
:CALCulate:CHPower:LIMit:POWer?	366
:CALCulate:CHPower:LIMit:POWer:FAIL?	367
:CALCulate:CHPower:LIMit:POWer:STATe OFF ON 0 1	366
:CALCulate:CHPower:LIMit:POWer:STATe?	366
:CALCulate:CHPower:LIMit:PSDeNSity <real>	368
:CALCulate:CHPower:LIMit:PSDeNSity?	368
:CALCulate:CHPower:LIMit:PSDeNSity:STATe OFF ON 0 1	368
:CALCulate:CHPower:LIMit:PSDeNSity:STATe?	368
:CALCulate:CHPower:LIMit:PSD:FAIL?	369
:CALCulate:CHPower:MARKer[1] 2 3 4 5 6 7 8 9 10 11 12:MAXimum	373
:CALCulate:CHPower:MARKer[1] 2 3 4 5 6 7 8 9 10 11 12:MODE POSition DELTA OFF	348

List of Commands

:CALCulate:CHPower:MARKer[1] 2 3 4 5 6 7 8 9 10 11 12:MODE?	348
:CALCulate:CHPower:MARKer[1] 2 3 4 5 6 7 8 9 10 11 12:REFeRence <integer>	351
:CALCulate:CHPower:MARKer[1] 2 3 4 5 6 7 8 9 10 11 12:REFeRence?	351
:CALCulate:CHPower:MARKer[1] 2 3 4 5 6 7 8 9 10 11 12:STATe OFF ON 0 1	353
:CALCulate:CHPower:MARKer[1] 2 3 4 5 6 7 8 9 10 11 12:STATe?	353
:CALCulate:CHPower:MARKer[1] 2 3 4 5 6 7 8 9 10 11 12:X <real>	349
:CALCulate:CHPower:MARKer[1] 2 3 4 5 6 7 8 9 10 11 12:X?	349
:CALCulate:CHPower:MARKer[1] 2 3 4 5 6 7 8 9 10 11 12:X:POSition <real>	350
:CALCulate:CHPower:MARKer[1] 2 3 4 5 6 7 8 9 10 11 12:X:POSition?	350
:CALCulate:CHPower:MARKer[1] 2 3 4 5 6 7 8 9 10 11 12:Y?	350
:CALCulate:CHPower:MARKer:AOFF	352
:CALCulate:CHPower:MARKer:COUPle[:STATe] ON OFF 1 0	352
:CALCulate:CHPower:MARKer:COUPle[:STATe]?	352
:CALCulate:CLIMits:FAIL?	1400
:CALCulate:DATA<n>:COMPress? BLOCk CFIT MAXimum MINimum MEAN DMEan RMS RM- SCubed SAMPle SDEVIation PPHase [,<soffset>[,<length>[,<roffset>[,<rlimit>]]]]	1401
:CALCulate:DATA[1] 2 3 4 5 6:PEAKs? <threshold>,<excursion>[,AMPLitude FREQuency TIME]	1406
:CALCulate:DATA[n]?	1400
:CALCulate:DATA:REGister[1] 2 3 4 5 6:EMPTy?	1857
:CALCulate:DATA:REGister[1] 2 3 4 5 6:REMOve	1857
:CALCulate:DATA:REGister:ALL:REMOve	1857
:CALCulate:EVM:DATA<n>:TABLe:NAMes?	747
:CALCulate:EVM:DATA<n>:TABLe:STRing?	747
:CALCulate:EVM:DATA<n>:TABLe:UNIT?	747
:CALCulate:LIMit[1] 2 3 4 5 6:CLEar	1433
:CALCulate:LIMit[1] 2 3 4 5 6:CONTrol[:DATA] <x>, <x>, ...	1431
:CALCulate:LIMit[1] 2 3 4 5 6:CONTrol[:DATA]?	1431
:CALCulate:LIMit[1] 2 3 4 5 6:CONTrol:POINts?	1431
:CALCulate:LIMit[1] 2 3 4 5 6:FAIL?	1433
:CALCulate:LIMit[1] 2 3 4 5 6:LOWer[:DATA] <ampl>, ...	1432
:CALCulate:LIMit[1] 2 3 4 5 6:LOWer[:DATA]?	1432

List of Commands

:CALCulate:LLIMit[1] 2 3 4 5 6:LOWer:POINts?	1432
:CALCulate:LLIMit[1] 2 3 4 5 6:STATe ON OFF 0 1	1430
:CALCulate:LLIMit[1] 2 3 4 5 6:STATe?	1430
:CALCulate:LLIMit[1] 2 3 4 5 6:UPPer[:DATA] <ampl>, <ampl>,	1432
:CALCulate:LLIMit[1] 2 3 4 5 6:UPPer[:DATA]?	1432
:CALCulate:LLIMit[1] 2 3 4 5 6:UPPer:POINts?.	1432
:CALCulate:LLINe[1] 2 3 4 5 6:AMPLitude:CMODE:RELative ON OFF 1 0	1420
:CALCulate:LLINe[1] 2 3 4 5 6:AMPLitude:CMODE:RELative?.	1420
:CALCulate:LLINe[1] 2 3 4 5 6:AMPLitude:INTerpolate:TYPE LOGarithmic LINear	1419
:CALCulate:LLINe[1] 2 3 4 5 6:AMPLitude:INTerpolate:TYPE?	1419
:CALCulate:LLINe[1] 2 3 4 5 6:BUILd TRACE1 TRACE2 TRACE3 TRACE4 TRACE5 TRACE6	1425
:CALCulate:LLINe[1] 2 3 4 5 6:COMMeNt "text"	1421
:CALCulate:LLINe[1] 2 3 4 5 6:COMMeNt?	1421
:CALCulate:LLINe[1] 2 3 4 5 6:CONTRol:INTerpolate:TYPE LOGarithmic LINear	1418
:CALCulate:LLINe[1] 2 3 4 5 6:CONTRol:INTerpolate:TYPE?	1418
:CALCulate:LLINe[1] 2 3 4 5 6:COpy LLINe1 LLINe2 LLINe3 LLINe4 LLINe5 LLINe6	1424
:CALCulate:LLINe[1] 2 3 4 5 6:DATA <x>,<ampl>,<connect>	1429
:CALCulate:LLINe[1] 2 3 4 5 6:DATA?.	1429
:CALCulate:LLINe[1] 2 3 4 5 6:DATA:MERGe <x-axis>,<ampl>,<connected>	1434
:CALCulate:LLINe[1] 2 3 4 5 6:DELeTe	1427
:CALCulate:LLINe[1] 2 3 4 5 6:DESCRiption "Description"	1421
:CALCulate:LLINe[1] 2 3 4 5 6:DESCRiption?	1421
:CALCulate:LLINe[1] 2 3 4 5 6:DISPlay OFF ON 0 1	1415
:CALCulate:LLINe[1] 2 3 4 5 6:DISPlay?	1415
:CALCulate:LLINe[1] 2 3 4 5 6:FAIL?	1430
:CALCulate:LLINe[1] 2 3 4 5 6:FREQuency:CMODE:RELative ON OFF 1 0	1419
:CALCulate:LLINe[1] 2 3 4 5 6:FREQuency:CMODE:RELative?	1419
:CALCulate:LLINe[1] 2 3 4 5 6:MARGin <rel_ampl>	1422
:CALCulate:LLINe[1] 2 3 4 5 6:MARGin?	1422
:CALCulate:LLINe[1] 2 3 4 5 6:MARGin:STATe OFF ON 0 1	1422
:CALCulate:LLINe[1] 2 3 4 5 6:MARGin:STATe?	1422

List of Commands

:CALCulate:LLINE[1] 2 3 4 5 6:OFFSet:UPDate	1426
:CALCulate:LLINE[1] 2 3 4 5 6:OFFSet:X <value>	1425
:CALCulate:LLINE[1] 2 3 4 5 6:OFFSet:X?	1425
:CALCulate:LLINE[1] 2 3 4 5 6:OFFSet:Y <rel ampl>	1426
:CALCulate:LLINE[1] 2 3 4 5 6:OFFSet:Y?	1426
:CALCulate:LLINE[1] 2 3 4 5 6:TRACe 1 2 3 4 5 6	1416
:CALCulate:LLINE[1] 2 3 4 5 6:TRACe?	1416
:CALCulate:LLINE[1] 2 3 4 5 6:TYPE UPPer LOWer	1417
:CALCulate:LLINE[1] 2 3 4 5 6:TYPE?	1417
:CALCulate:LLINE:ALL:DELeTe	1429
:CALCulate:LLINE:CMODE FIXed RELative	1434
:CALCulate:LLINE:CMODE?	1434
:CALCulate:LLINE:CONTRol:DOMain FREQuency TIME	1428
:CALCulate:LLINE:CONTRol:DOMain?	1428
:CALCulate:LLINE:TEST OFF ON 0 1	1428
:CALCulate:LLINE:TEST?	1428
:CALCulate:MAMarker:COUPling ON OFF 1 0	1390
:CALCulate:MAMarker:COUPling?	1390
:CALCulate:MAMarker:DETEctor[1] 2 3 OFF NORMAl AVERAge POSitive SAMPle NEGative QPEak EAVer- age RAverage	1386
:CALCulate:MAMarker:DETEctor[1] 2 3?	1386
:CALCulate:MAMarker:DETEctor[1] 2 3:DWELI <dwel time>	1386
:CALCulate:MAMarker:DETEctor[1] 2 3:DWELI?	1386
:CALCulate:MAMarker:PCENter ON OFF 1 0	1391
:CALCulate:MAMarker:PCENter?	1391
:CALCulate:MARKer[1] 2 3 4 5 6 7 8 9 10 11 12:CPSearch[:STATe] ON OFF 1 0	1482
:CALCulate:MARKer[1] 2 3 4 5 6 7 8 9 10 11 12:CPSearch[:STATe]?	1482
:CALCulate:MARKer[1] 2 3 4 5 6 7 8 9 10 11 12:FCOunt:GATetime <time>	1371
:CALCulate:MARKer[1] 2 3 4 5 6 7 8 9 10 11 12:FCOunt:GATetime?	1371
:CALCulate:MARKer[1] 2 3 4 5 6 7 8 9 10 11 12:FCOunt:GATetime:AUTO OFF ON 0 1	1371
:CALCulate:MARKer[1] 2 3 4 5 6 7 8 9 10 11 12:FCOunt:GATetime:AUTO?	1371

List of Commands

:CALCulate:MARKer[1] 2 3 4 5 6 7 8 9 10 11 12:FCOut[:STATe] OFF ON 0 1	1367
:CALCulate:MARKer[1] 2 3 4 5 6 7 8 9 10 11 12:FCOut[:STATe]?	1367
:CALCulate:MARKer[1] 2 3 4 5 6 7 8 9 10 11 12:FCOut:X?	1368
:CALCulate:MARKer[1] 2 3 4 5 6 7 8 9 10 11 12:FUNCTion NOISe BPOWer BDENsity OFF	1372
:CALCulate:MARKer[1] 2 3 4 5 6 7 8 9 10 11 12:FUNCTion?	1372
:CALCulate:MARKer[1] 2 3 4 5 6 7 8 9 10 11 12:FUNCTion:BAND:LEFT <freq>	1379
:CALCulate:MARKer[1] 2 3 4 5 6 7 8 9 10 11 12:FUNCTion:BAND:LEFT?	1379
:CALCulate:MARKer[1] 2 3 4 5 6 7 8 9 10 11 12:FUNCTion:BAND:RIGHT <freq>	1380
:CALCulate:MARKer[1] 2 3 4 5 6 7 8 9 10 11 12:FUNCTion:BAND:RIGHT?	1380
:CALCulate:MARKer[1] 2 3 4 5 6 7 8 9 10 11 12:FUNCTion:BAND:SPAN <freq>	1378
:CALCulate:MARKer[1] 2 3 4 5 6 7 8 9 10 11 12:FUNCTion:BAND:SPAN?	1378
:CALCulate:MARKer[1] 2 3 4 5 6 7 8 9 10 11 12:FUNCTion:MAMarker?	1382
:CALCulate:MARKer[1] 2 3 4 5 6 7 8 9 10 11 12:LINEs[:STATe] OFF ON 0 1	1366
:CALCulate:MARKer[1] 2 3 4 5 6 7 8 9 10 11 12:LINEs[:STATe]?	1366
:CALCulate:MARKer[1] 2 3 4 5 6 7 8 9 10 11 12:MAXimum	1471
:CALCulate:MARKer[1] 2 3 4 5 6 7 8 9 10 11 12:MAXimum:LEFT	1472
:CALCulate:MARKer[1] 2 3 4 5 6 7 8 9 10 11 12:MAXimum:NEXT	1471
:CALCulate:MARKer[1] 2 3 4 5 6 7 8 9 10 11 12:MAXimum:RIGHT	1472
:CALCulate:MARKer[1] 2 3 4 5 6 7 8 9 10 11 12:MINimum	1484
:CALCulate:MARKer[1] 2 3 4 5 6 7 8 9 10 11 12:MODE POSition DELTA FIXed OFF	1353
:CALCulate:MARKer[1] 2 3 4 5 6 7 8 9 10 11 12:MODE?	1353
:CALCulate:MARKer[1] 2 3 4 5 6 7 8 9 10 11 12:PTPeak	1483
:CALCulate:MARKer[1] 2 3 4 5 6 7 8 9 10 11 12:REFerence <integer>	1360
:CALCulate:MARKer[1] 2 3 4 5 6 7 8 9 10 11 12:REFerence?	1360
:CALCulate:MARKer[1] 2 3 4 5 6 7 8 9 10 11 12[:SET]:CENTer	1392
:CALCulate:MARKer[1] 2 3 4 5 6 7 8 9 10 11 12[:SET]:DELTA:CENTer	1394
:CALCulate:MARKer[1] 2 3 4 5 6 7 8 9 10 11 12[:SET]:DELTA:SPAN	1394
:CALCulate:MARKer[1] 2 3 4 5 6 7 8 9 10 11 12[:SET]:RLEVel	1395
:CALCulate:MARKer[1] 2 3 4 5 6 7 8 9 10 11 12[:SET]:STARt	1393
:CALCulate:MARKer[1] 2 3 4 5 6 7 8 9 10 11 12[:SET]:STEP	1392
:CALCulate:MARKer[1] 2 3 4 5 6 7 8 9 10 11 12[:SET]:STOP	1393

List of Commands

:CALCulate:MARKer[1] 2 3 4 5 6 7 8 9 10 11 12:TRACe 1 2 3 4 5 6	1364
:CALCulate:MARKer[1] 2 3 4 5 6 7 8 9 10 11 12:TRACe?	1364
:CALCulate:MARKer[1] 2 3 4 5 6 7 8 9 10 11 12:TRACe:AUTO OFF ON 0 1	1365
:CALCulate:MARKer[1] 2 3 4 5 6 7 8 9 10 11 12:TRACe:AUTO?	1365
:CALCulate:MARKer[1] 2 3 4 5 6 7 8 9 10 11 12:X <freq>	1354
:CALCulate:MARKer[1] 2 3 4 5 6 7 8 9 10 11 12:X?	1354
:CALCulate:MARKer[1] 2 3 4 5 6 7 8 9 10 11 12:X:POSition <real>	1355
:CALCulate:MARKer[1] 2 3 4 5 6 7 8 9 10 11 12:X:POSition?	1355
:CALCulate:MARKer[1] 2 3 4 5 6 7 8 9 10 11 12:X:READout FREQuency TIME ITIME PERiod	1361
:CALCulate:MARKer[1] 2 3 4 5 6 7 8 9 10 11 12:X:READout?	1361
:CALCulate:MARKer[1] 2 3 4 5 6 7 8 9 10 11 12:X:READout:AUTO ON OFF 1 0	1361
:CALCulate:MARKer[1] 2 3 4 5 6 7 8 9 10 11 12:X:READout:AUTO?	1361
:CALCulate:MARKer[1] 2 3 4 5 6 7 8 9 10 11 12:Y <real>	1356
:CALCulate:MARKer[1] 2 3 4 5 6 7 8 9 10 11 12:Y?	1356
:CALCulate:MARKer:AOFF	1372
:CALCulate:MARKer:COUPle[:STATe] OFF ON 0 1	1371
:CALCulate:MARKer:COUPle[:STATe]?	1371
:CALCulate:MARKer:PEAK:EXCursion <rel_ampl>	1476
:CALCulate:MARKer:PEAK:EXCursion?	1476
:CALCulate:MARKer:PEAK:EXCursion:STATe OFF ON 0 1	1476
:CALCulate:MARKer:PEAK:EXCursion:STATe?	1476
:CALCulate:MARKer:PEAK:SEARch:MODE MAXimum PARAmeter	1474
:CALCulate:MARKer:PEAK:SEARch:MODE?	1474
:CALCulate:MARKer:PEAK:SORT FREQuency AMPLitude	1479
:CALCulate:MARKer:PEAK:SORT?	1479
:CALCulate:MARKer:PEAK:TABLE:READout ALL GTDLine LTDLine	1480
:CALCulate:MARKer:PEAK:TABLE:READout?	1480
:CALCulate:MARKer:PEAK:TABLE:STATe OFF ON 0 1	1479
:CALCulate:MARKer:PEAK:TABLE:STATe?	1479
:CALCulate:MARKer:PEAK:THReshold <ampl>	1477
:CALCulate:MARKer:PEAK:THReshold?	1477

List of Commands

:CALCulate:MARKer:PEAK:THReshold:STATe OFF ON 0 1	1477
:CALCulate:MARKer:PEAK:THReshold:STATe?	1477
:CALCulate:MARKer:TABLE[:STATe] OFF ON 0 1	1367
:CALCulate:MARKer:TABLE[:STATe]?	1367
:CALCulate:MATH TRACE1 TRACE2 TRACE3 TRACE4 TRACE5 TRACE6, PDIFference PSUM LOFF- set LDIFference OFF, TRACE1 TRACE2 TRACE3 TRACE4 TRACE5 TRACE6, TRACE1 TRACE2 TRACE3 TRACE4 TRACE5 TRACE6, <real>,<real>	1687
:CALCulate:MATH? TRACE1 TRACE2 TRACE3 TRACE4 TRACE5 TRACE6	1687
:CALCulate:NTData[:STATe] OFF ON 0 1	1694
:CALCulate:NTData[:STATe]?	1694
:CALCulate:OBWidth:LIMit:FBLimit <freq>	427
:CALCulate:OBWidth:LIMit:FBLimit?	427
:CALCulate:OBWidth:LIMit[:TEST] ON OFF 1 0	427
:CALCulate:OBWidth:LIMit[:TEST]?	427
:CALCulate:OBWidth:MARKer[1] 2 3 4 5 6 7 8 9 10 11 12:MAXimum	431
:CALCulate:OBWidth:MARKer[1] 2 3 4 5 6 7 8 9 10 11 12:MODE POSition DELTA OFF	415
:CALCulate:OBWidth:MARKer[1] 2 3 4 5 6 7 8 9 10 11 12:MODE?	415
:CALCulate:OBWidth:MARKer[1] 2 3 4 5 6 7 8 9 10 11 12:REFerence <integer>	416
:CALCulate:OBWidth:MARKer[1] 2 3 4 5 6 7 8 9 10 11 12:REFerence?	416
:CALCulate:OBWidth:MARKer[1] 2 3 4 5 6 7 8 9 10 11 12:STATe OFF ON 0 1	417
:CALCulate:OBWidth:MARKer[1] 2 3 4 5 6 7 8 9 10 11 12:STATe?	417
:CALCulate:OBWidth:MARKer[1] 2 3 4 5 6 7 8 9 10 11 12:X <freq>	413
:CALCulate:OBWidth:MARKer[1] 2 3 4 5 6 7 8 9 10 11 12:X?	413
:CALCulate:OBWidth:MARKer[1] 2 3 4 5 6 7 8 9 10 11 12:X:POSition <real>	414
:CALCulate:OBWidth:MARKer[1] 2 3 4 5 6 7 8 9 10 11 12:X:POSition?	414
:CALCulate:OBWidth:MARKer[1] 2 3 4 5 6 7 8 9 10 11 12:Y?	414
:CALCulate:OBWidth:MARKer:AOFF	417
:CALCulate:PVTime:MARKer[1] 2 3 4 5 6 7 8 9 10 11 12:MODE POSition DELTA OFF	696
:CALCulate:PVTime:MARKer[1] 2 3 4 5 6 7 8 9 10 11 12:MODE?	696
:CALCulate:PVTime:MARKer[1] 2 3 4 5 6 7 8 9 10 11 12:REFerence <integer>	700
:CALCulate:PVTime:MARKer[1] 2 3 4 5 6 7 8 9 10 11 12:REFerence?	700
:CALCulate:PVTime:MARKer[1] 2 3 4 5 6 7 8 9 10 11 12:STATe OFF ON 0 1	701

List of Commands

:CALCulate:PVTime:MARKer[1] 2 3 4 5 6 7 8 9 10 11 12:STATe?	701
:CALCulate:PVTime:MARKer[1] 2 3 4 5 6 7 8 9 10 11 12:TRACe RFENvelope UMASk LMASk MAXHold MIN-Hold	700
:CALCulate:PVTime:MARKer[1] 2 3 4 5 6 7 8 9 10 11 12:TRACe?	700
:CALCulate:PVTime:MARKer[1] 2 3 4 5 6 7 8 9 10 11 12:X <real>	697
:CALCulate:PVTime:MARKer[1] 2 3 4 5 6 7 8 9 10 11 12:X?	697
:CALCulate:PVTime:MARKer[1] 2 3 4 5 6 7 8 9 10 11 12:X:POSition <real>	698
:CALCulate:PVTime:MARKer[1] 2 3 4 5 6 7 8 9 10 11 12:X:POSition?	698
:CALCulate:PVTime:MARKer[1] 2 3 4 5 6 7 8 9 10 11 12:Y?	699
:CALCulate:PVTime:MARKer:AOFF	701
:CALCulate:PVTime:MARKer:COUPle[:STATe] ON OFF 1 0	701
:CALCulate:PVTime:MARKer:COUPle[:STATe]?	701
:CALCulate:SEMAsk:LLINe:STATe ON OFF 1 0	678
:CALCulate:SEMAsk:LLINe:STATe?	678
:CALCulate:SEMAsk:MARKer[1] 2 3 4 5 6 7 8 9 10 11 12:MODE POSition OFF	580
:CALCulate:SEMAsk:MARKer[1] 2 3 4 5 6 7 8 9 10 11 12:MODE?	580
:CALCulate:SEMAsk:MARKer[1] 2 3 4 5 6 7 8 9 10 11 12:X <freq>	581
:CALCulate:SEMAsk:MARKer[1] 2 3 4 5 6 7 8 9 10 11 12:X?	581
:CALCulate:SEMAsk:MARKer[1] 2 3 4 5 6 7 8 9 10 11 12:X:POSition <real>	582
:CALCulate:SEMAsk:MARKer[1] 2 3 4 5 6 7 8 9 10 11 12:X:POSition?	582
:CALCulate:SEMAsk:MARKer[1] 2 3 4 5 6 7 8 9 10 11 12:Y?	583
:CALCulate:SEMAsk:MARKer:AOFF	584
:CALCulate:SEMAsk:MARKer:COUPle[:STATe] ON OFF 1 0	583
:CALCulate:SEMAsk:MARKer:COUPle[:STATe]?	583
:CALCulate:TRACe[1] 2 3 4 5 6:FAIL?	1433
:CALibration[:ALL]?	263
:CALibration[:ALL]	263
:CALibration:AUTO ON PARTial OFF	255
:CALibration:AUTO?	255
:CALibration:AUTO:ALERt TTEMperature DAY WEEK NONE	259
:CALibration:AUTO:ALERt?	259

List of Commands

:CALibration:AUTO:MODE ALL NRF	258
:CALibration:AUTO:MODE?	258
:CALibration:AUTO:TIME:OFF?	273
:CALibration:DATA:BACKUp <filename>	282
:CALibration:DATA:DEFault	276
:CALibration:DATA:REStore <filename>	282
:CALibration:EMIXer?	267
:CALibration:EMIXer	267
:CALibration:EXPIred?	262
:CALibration:FREQuency:REFerence:COARse <integer>	287
:CALibration:FREQuency:REFerence:COARse?	287
:CALibration:FREQuency:REFerence:FINE <integer>	287
:CALibration:FREQuency:REFerence:FINE?	287
:CALibration:FREQuency:REFerence:MODE CALibrated USER	286
:CALibration:FREQuency:REFerence:MODE?	286
:CALibration:INTernal:SOURce[:ALL]?	268
:CALibration:INTernal:SOURce[:ALL]	268
:CALibration:MPADapter:CABLEs:TEST	325
:CALibration:MPADapter:GAIN?	285
:CALibration:MPADapter:GAIN	285
:CALibration:NRF?	265
:CALibration:NRF	265
:CALibration:RF?	266
:CALibration:RFPSelector:ALERt ON OFF 0 1	292
:CALibration:RFPSelector:ALERt?	292
:CALibration:RFPSelector:CONDUCTed?	288
:CALibration:RFPSelector:CONDUCTed	288
:CALibration:RFPSelector:FULL?	291
:CALibration:RFPSelector:FULL	291
:CALibration:RFPSelector:RADiated?	290
:CALibration:RFPSelector:RADiated	290

List of Commands

:CALibration:RFPSelector:SCHeDuler:RECurrence DAY WEEK OFF	295
:CALibration:RFPSelector:SCHeDuler:RECurrence?	295
:CALibration:RFPSelector:SCHeDuler:RECurrence:DAY SUN MON TUE WED THU FRI SAT	296
:CALibration:RFPSelector:SCHeDuler:RECurrence:DAY?	296
:CALibration:RFPSelector:SCHeDuler:RECurrence:WEEK <integer>	296
:CALibration:RFPSelector:SCHeDuler:RECurrence:WEEK?	296
:CALibration:RFPSelector:SCHeDuler:STAtE ON OFF 0 1	297
:CALibration:RFPSelector:SCHeDuler:STAtE?	297
:CALibration:RFPSelector:SCHeDuler:TASK T1 T2 T3	293
:CALibration:RFPSelector:SCHeDuler:TASK?	293
:CALibration:RFPSelector:SCHeDuler:TIME:NEXT?	274
:CALibration:RFPSelector:SCHeDuler:TIME:STArT "date","time"	293
:CALibration:RFPSelector:SCHeDuler:TIME:STArT?	293
:CALibration:RF	266
:CALibration:SOURce:STAtE OFF ON 0 1	1287
:CALibration:SOURce:STAtE?	1287
:CALibration:TEMPerature:CURRent?	270
:CALibration:TEMPerature:LALL?	270
:CALibration:TEMPerature:LPReSelector?	272
:CALibration:TEMPerature:LRF?	271
:CALibration:TEMPerature:RFPSelector:LCONducteD?	273
:CALibration:TEMPerature:RFPSelector:LRADiated?	274
:CALibration:TEMPerature:SOURce: LALL?	272
:CALibration:TIME:LALL?	270
:CALibration:TIME:LPReSelector?	272
:CALibration:TIME:LRF?	271
:CALibration:TIME:RFPSelector:LCONducteD?	273
:CALibration:TIME:RFPSelector:LRADiated?	273
:CALibration:TIME:SOURce:LALL?	271
:CALibration:YTF?	283
:CALibration:YTF	283

List of Commands

*CLS	185
:CONFigure:<Measurement>	201
:CONFigure?	1400
:CONFigure:ACP	457
:CONFigure:ACP:NDEFault	457
:CONFigure:ACPower	521
:CONFigure:CEVM:NDEFault	1179
:CONFigure:CEVM	1179
:CONFigure:CHPower	370
:CONFigure:CHPower:NDEFault	333
:CONFigure:CHPower	333
:CONFigure:EVM	747
:CONFigure:OBWidth	428
:CONFigure:OBWidth:NDEFault	399
:CONFigure:OBWidth	399
:CONFigure:PVTime	715
:CONFigure:PVTime:NDEFault	679
:CONFigure:PVTime	679
:CONFigure:SEMask	625
:CONFigure:SEMask:NDEFault	553
:CONFigure:SEMask	553
:COUple ALL NONE	1259
:DISPlay:<meas>:AFPoints OFF ON 0 1	1825
:DISPlay:<meas>:AFPoints?	1825
:DISPlay:<meas>:FANNotation CSPan SSTop	1825
:DISPlay:<meas>:FANNotation?	1825
:DISPlay:<meas>:TRACe[1] 2 3 4:COPIY D1 D2 D3 D4 D5 D6	1856
:DISPlay:<meas>:TRACe[1] 2 3 4:DDEMod:ALIN?	1856
:DISPlay:<meas>:TRACe[1] 2 3 4:DDEMod:ALINe OFF ON 0 1	1856
:DISPlay:<meas>:TRACe[1] 2 3 4:DDEMod:EYE:COUNt <real>	1854
:DISPlay:<meas>:TRACe[1] 2 3 4:DDEMod:EYE:COUNt?	1854

List of Commands

:DISPlay:<meas>:TRACe[1] 2 3 4:DDEMod:SYMBol BARS DOTS OFF	1851
:DISPlay:<meas>:TRACe[1] 2 3 4:DDEMod:SYMBol?	1851
:DISPlay:<meas>:TRACe[1] 2 3 4:DDEMod:SYMBol:FORMat HEXadecimal BINary	1853
:DISPlay:<meas>:TRACe[1] 2 3 4:DDEMod:SYMBol:FORMat?	1853
:DISPlay:<meas>:TRACe[1] 2 3 4:DDEMod:SYMBol:SHAPE CIRCLE CROSS OFF	1852
:DISPlay:<meas>:TRACe[1] 2 3 4:DDEMod:SYMBol:SHAPE?	1852
:DISPlay:<meas>:TRACe[1] 2 3 4:DDEMod:SYMBol:SIZE <real>	1852
:DISPlay:<meas>:TRACe[1] 2 3 4:DDEMod:SYMBol:SIZE?	1852
:DISPlay:<meas>:TRACe[1] 2 3 4:DDEMod:UNIT:FREQuency CARRier HZ	1855
:DISPlay:<meas>:TRACe[1] 2 3 4:DDEMod:UNIT:FREQuency?	1855
:DISPlay:<meas>:TRACe[1] 2 3 4:DDEMod:UNIT:TIME SEC SYMBol	1855
:DISPlay:<meas>:TRACe[1] 2 3 4:DDEMod:UNIT:TIME?	1855
:DISPlay:<meas>:TRACe[1] 2 3 4:FEED <string>	1833
:DISPlay:<meas>:TRACe[1] 2 3 4:FEED?	1833
:DISPlay:<meas>:TRACe[1] 2 3 4:FORMat MLOG MLINear REAL IMAGinary VECTor CONS PHASe UP- Hase IEYE QEYE TRELis GDELay MLGLinear	1850
:DISPlay:<meas>:TRACe[1] 2 3 4:FORMat?	1850
:DISPlay:<meas>:TRACe[1] 2 3 4:FORMat:DELay:APERture <real>	1859
:DISPlay:<meas>:TRACe[1] 2 3 4:FORMat:DELay:APERture?	1859
:DISPlay:<meas>:TRACe[1] 2 3 4:FORMat:PHASe:OFFSet <real>	1858
:DISPlay:<meas>:TRACe[1] 2 3 4:FORMat:PHASe:OFFSet?	1858
:DISPlay:<meas>:TRACe[1] 2 3 4:FORMat:PHASe:UNWRap:REFERence <real>	1859
:DISPlay:<meas>:TRACe[1] 2 3 4:FORMat:PHASe:UNWRap:REFERence?	1859
:DISPlay:<meas>:TRACe[1] 2 3 4:RLINE OFF ON 0 1 :DISPlay:<meas>:TRACe[1] 2 3 4:RLINE?	1766
:DISPlay:<meas>:TRACe[1] 2 3 4:VHCenter <real>	1765
:DISPlay:<meas>:TRACe[1] 2 3 4:VHCenter?	1765
:DISPlay:<meas>:TRACe[1] 2 3 4:X[:SCALE]:COUple OFF ON 0 1	1822
:DISPlay:<meas>:TRACe[1] 2 3 4:X[:SCALE]:COUple?	1822
:DISPlay:<meas>:TRACe[1] 2 3 4:X[:SCALE]:RLEVel <real>	1823
:DISPlay:<meas>:TRACe[1] 2 3 4:X[:SCALE]:RLEVel?	1823
:DISPlay:<meas>:TRACe[1] 2 3 4:X[:SCALE]:RPOsition LEFT CENTer RIGHt	1824

List of Commands

:DISPlay:<meas>:TRACe[1] 2 3 4:X[:SCALe]:RPOStion?	1824
:DISPlay:<meas>:TRACe[1] 2 3 4:X[:SCALe]:SPAN <real>	1823
:DISPlay:<meas>:TRACe[1] 2 3 4:X[:SCALe]:SPAN?	1823
:DISPlay:<meas>:TRACe[1] 2 3 4:Y:LRATio <real>	1764
:DISPlay:<meas>:TRACe[1] 2 3 4:Y:LRATio?	1764
:DISPlay:<meas>:TRACe[1] 2 3 4:Y[:SCALe]:AUTO:ONCE	1760
:DISPlay:<meas>:TRACe[1] 2 3 4:Y[:SCALe]:PDIVision <real>	1762
:DISPlay:<meas>:TRACe[1] 2 3 4:Y[:SCALe]:PDIVision?	1762
:DISPlay:<meas>:TRACe[1] 2 3 4:Y[:SCALe]:RLEVel <real>	1761
:DISPlay:<meas>:TRACe[1] 2 3 4:Y[:SCALe]:RLEVel?	1761
:DISPlay:<meas>:TRACe[1] 2 3 4:Y[:SCALe]:RLEVel:AUTO OFF ON 0 1	1762
:DISPlay:<meas>:TRACe[1] 2 3 4:Y[:SCALe]:RLEVel:AUTO?	1762
:DISPlay:<meas>:TRACe[1] 2 3 4:Y[:SCALe]:RPOStion TOP CENTer BOTTom	1763
:DISPlay:<meas>:TRACe[1] 2 3 4:Y[:SCALe]:RPOStion?	1763
:DISPlay:<meas>:TRACe[1] 2 3 4:Y:UNIT?	1764
:DISPlay:<meas>:TRACe[1] 2 3 4:Y:UNIT:PREFerence AUTO PEAK RMS POWER MRMS	1763
:DISPlay:<meas>:TRACe[1] 2 3 4:Y:UNIT:PREFerence?	1763
:DISPlay:<meas>:WINDow:FORMat SINGle TWO TRI QUAD GR2X3 GR3X2	1893
:DISPlay:<meas>:WINDow:FORMat SINGle TWO TRI QUAD	1893
:DISPlay:<meas>:WINDow:FORMat?	1893
:DISPlay:<meas>:WINDow:FORMat?	1893
:DISPlay:<measurement>:ANNotation:TITLe:DATA <string>	1752
:DISPlay:<measurement>:ANNotation:TITLe:DATA?	1752
:DISPlay:ACPower:VIEW[1]:WINDow[1]:BGRaph OFF ON 0 1	551
:DISPlay:ACPower:VIEW[1]:WINDow[1]:BGRaph?	551
:DISPlay:ACPower:VIEW[1]:WINDow[1]:TRACe:Y[:SCALe]:COUple 0 1 OFF ON	467
:DISPlay:ACPower:VIEW[1]:WINDow[1]:TRACe:Y[:SCALe]:COUple?	467
:DISPlay:ACPower:VIEW[1]:WINDow[1]:TRACe:Y[:SCALe]:PDIVision <rel_ampl>	465
:DISPlay:ACPower:VIEW[1]:WINDow[1]:TRACe:Y[:SCALe]:PDIVision?	465
:DISPlay:ACPower:VIEW[1]:WINDow[1]:TRACe:Y[:SCALe]:RLEVel <real>	464
:DISPlay:ACPower:VIEW[1]:WINDow[1]:TRACe:Y[:SCALe]:RLEVel?	464

List of Commands

:DISPlay:ACPower:VIEW[1]:WINDow[1]:TRACe:Y[:SCALe]:RPOSition TOP CENTer BOTTom	466
:DISPlay:ACPower:VIEW[1]:WINDow[1]:TRACe:Y[:SCALe]:RPOSition?	466
:DISPlay:ACTivefunc[:STATe] ON OFF 1 0	1751
:DISPlay:ACTivefunc[:STATe]?	1751
:DISPlay:ANNotation:MBAR[:STATe] OFF ON 0 1	1749
:DISPlay:ANNotation:MBAR[:STATe]?	1749
:DISPlay:ANNotation:SCReen[:STATe] OFF ON 0 1	1750
:DISPlay:ANNotation:SCReen[:STATe]?	1750
:DISPlay:ANNotation:TRACe[:STATe] ON OFF 1 0	1750
:DISPlay:ANNotation:TRACe[:STATe]?	1750
:DISPlay:BACKlight ON OFF	1756
:DISPlay:BACKlight?	1756
:DISPlay:BACKlight:INTensity <integer>	1756
:DISPlay:BACKlight:INTensity?	1756
:DISPlay:CEVM:VIEW[:SELEct] MLISt PARAmeter RESult RFENvelope	1213
:DISPlay:CEVM:VIEW[:SELEct]?	1213
:DISPlay:CHPower:VIEW[1]:WINDow[1]:BGRaph ON OFF 1 0	397
:DISPlay:CHPower:VIEW[1]:WINDow[1]:BGRaph?	397
:DISPlay:CHPower:VIEW[1]:WINDow[1]:TRACe:Y[:SCALe]:COUPle 0 1 OFF ON	339
:DISPlay:CHPower:VIEW[1]:WINDow[1]:TRACe:Y[:SCALe]:COUPle?	339
:DISPlay:CHPower:VIEW[1]:WINDow[1]:TRACe:Y[:SCALe]:PDIVision <rel_amp >	337
:DISPlay:CHPower:VIEW[1]:WINDow[1]:TRACe:Y[:SCALe]:PDIVision?	337
:DISPlay:CHPower:VIEW[1]:WINDow[1]:TRACe:Y[:SCALe]:RLEVel <real>	336
:DISPlay:CHPower:VIEW[1]:WINDow[1]:TRACe:Y[:SCALe]:RLEVel?	336
:DISPlay:CHPower:VIEW[1]:WINDow[1]:TRACe:Y[:SCALe]:RPOSition TOP CENTer BOTTom	338
:DISPlay:CHPower:VIEW[1]:WINDow[1]:TRACe:Y[:SCALe]:RPOSition?	338
:DISPlay:ENABle OFF ON 0 1	1758
:DISPlay:ENABle?	1758
:DISPlay:EVM:VIEW:PRESet BASic	1172
:DISPlay:EVM:VIEW:PRESet BASic SUMMery RBSLot SUBCarrier MIMO	1172
:DISPlay:EVM:VIEW:PRESet MIMO	1177

List of Commands

:DISPlay:EVM:VIEW:PRESet RBSLot	1175
:DISPlay:EVM:VIEW:PRESet SUBCarrier	1176
:DISPlay:EVM:VIEW:PRESet SUMMary	1173
:DISPlay:FSCReen[:STATe] OFF ON 0 1	1757
:DISPlay:FSCReen[:STATe]?	1757
:DISPlay:OBWidth:VIEW[1]:WINDow[1]:TRACe:Y[:SCALe]:COUPlE 0 1 OFF ON	404
:DISPlay:OBWidth:VIEW[1]:WINDow[1]:TRACe:Y[:SCALe]:COUPlE?	404
:DISPlay:OBWidth:VIEW[1]:WINDow[1]:TRACe:Y[:SCALe]:PDIVision <rel_ampl>	402
:DISPlay:OBWidth:VIEW[1]:WINDow[1]:TRACe:Y[:SCALe]:PDIVision?	402
:DISPlay:OBWidth:VIEW[1]:WINDow[1]:TRACe:Y[:SCALe]:RLEVel <real>	401
:DISPlay:OBWidth:VIEW[1]:WINDow[1]:TRACe:Y[:SCALe]:RLEVel?	401
:DISPlay:OBWidth:VIEW[1]:WINDow[1]:TRACe:Y[:SCALe]:RPOSition TOP CENTer BOTTom	403
:DISPlay:OBWidth:VIEW[1]:WINDow[1]:TRACe:Y[:SCALe]:RPOSition?	403
:DISPlay:PVTime:RAMP[:STATe] OFF ON 0 1	744
:DISPlay:PVTime:RAMP[:STATe]?	744
:DISPlay:PVTime:VIEW[1]:WINDow[1]:BLINes[:STATe] ON OFF 1 0	741
:DISPlay:PVTime:VIEW[1]:WINDow[1]:BLINes[:STATe]?	741
:DISPlay:PVTime:VIEW[1]:WINDow[1]:LIMit:MASK OFF ON 0 1	742
:DISPlay:PVTime:VIEW[1]:WINDow[1]:LIMit:MASK?	742
:DISPlay:PVTime:VIEW[1]:WINDow[1]:TRACe:MAXHold[:STATe] ON OFF 1 0	732
:DISPlay:PVTime:VIEW[1]:WINDow[1]:TRACe:MAXHold[:STATe]?	732
:DISPlay:PVTime:VIEW[1]:WINDow[1]:TRACe:MINHold[:STATe] ON OFF 1 0	733
:DISPlay:PVTime:VIEW[1]:WINDow[1]:TRACe:MINHold[:STATe]?	733
:DISPlay:PVTime:VIEW[1]:WINDow[1]:TRACe:X[:SCALe]:COUPlE 0 1 OFF ON	729
:DISPlay:PVTime:VIEW[1]:WINDow[1]:TRACe:X[:SCALe]:COUPlE?	729
:DISPlay:PVTime:VIEW[1]:WINDow[1]:TRACe:X[:SCALe]:PDIVision <time>	727
:DISPlay:PVTime:VIEW[1]:WINDow[1]:TRACe:X[:SCALe]:PDIVision?	727
:DISPlay:PVTime:VIEW[1]:WINDow[1]:TRACe:X[:SCALe]:RLEVel <time>	726
:DISPlay:PVTime:VIEW[1]:WINDow[1]:TRACe:X[:SCALe]:RLEVel?	726
:DISPlay:PVTime:VIEW[1]:WINDow[1]:TRACe:X[:SCALe]:RPOSition LEFT CENTer RIGHT	728
:DISPlay:PVTime:VIEW[1]:WINDow[1]:TRACe:X[:SCALe]:RPOSition?	728

List of Commands

:DISPlay:PVTime:VIEW[1]:WINDow[1]:TRACe:Y[:SCALe]:COUPlE 0 1 OFF ON	688
:DISPlay:PVTime:VIEW[1]:WINDow[1]:TRACe:Y[:SCALe]:COUPlE?	688
:DISPlay:PVTime:VIEW[1]:WINDow[1]:TRACe:Y[:SCALe]:PDIVision <rel_ampl>	685
:DISPlay:PVTime:VIEW[1]:WINDow[1]:TRACe:Y[:SCALe]:PDIVision?	685
:DISPlay:PVTime:VIEW[1]:WINDow[1]:TRACe:Y[:SCALe]:RLEVel <real>	684
:DISPlay:PVTime:VIEW[1]:WINDow[1]:TRACe:Y[:SCALe]:RLEVel?	684
:DISPlay:PVTime:VIEW[1]:WINDow[1]:TRACe:Y[:SCALe]:RPOStion TOP CENTer BOTTom	687
:DISPlay:PVTime:VIEW[1]:WINDow[1]:TRACe:Y[:SCALe]:RPOStion?	687
:DISPlay:PVTime:VIEW[1]:WINDow[1]:TRIGger[:STATe] ON OFF 1 0	741
:DISPlay:PVTime:VIEW[1]:WINDow[1]:TRIGger[:STATe]?	741
:DISPlay:PVTime:VIEW2:WINDow[1]2:TRACe:X[:SCALe]:COUPlE 0 1 OFF ON	730
:DISPlay:PVTime:VIEW2:WINDow[1]2:TRACe:X[:SCALe]:COUPlE?	730
:DISPlay:PVTime:VIEW2:WINDow[1]2:TRACe:X[:SCALe]:PDIVision <time>	728
:DISPlay:PVTime:VIEW2:WINDow[1]2:TRACe:X[:SCALe]:PDIVision?	728
:DISPlay:PVTime:VIEW2:WINDow[1]2:TRACe:X[:SCALe]:RLEVel <time>	727
:DISPlay:PVTime:VIEW2:WINDow[1]2:TRACe:X[:SCALe]:RLEVel?	727
:DISPlay:PVTime:VIEW2:WINDow[1]2:TRACe:X[:SCALe]:RPOStion LEFT CENTer RIGHT	729
:DISPlay:PVTime:VIEW2:WINDow[1]2:TRACe:X[:SCALe]:RPOStion?	729
:DISPlay:PVTime:VIEW2:WINDow[1]2:TRACe:Y[:SCALe]:COUPlE 0 1 OFF ON	689
:DISPlay:PVTime:VIEW2:WINDow[1]2:TRACe:Y[:SCALe]:COUPlE?	689
:DISPlay:PVTime:VIEW2:WINDow[1]2:TRACe:Y[:SCALe]:PDIVision <rel_ampl>	686
:DISPlay:PVTime:VIEW2:WINDow[1]2:TRACe:Y[:SCALe]:PDIVision?	686
:DISPlay:PVTime:VIEW2:WINDow[1]2:TRACe:Y[:SCALe]:RLEVel <real>	685
:DISPlay:PVTime:VIEW2:WINDow[1]2:TRACe:Y[:SCALe]:RLEVel?	685
:DISPlay:PVTime:VIEW2:WINDow[1]2:TRACe:Y[:SCALe]:RPOStion TOP CENTer BOTTom	688
:DISPlay:PVTime:VIEW2:WINDow[1]2:TRACe:Y[:SCALe]:RPOStion?	688
:DISPlay:PVTime:VIEW:NSElect <integer>	735
:DISPlay:PVTime:VIEW:NSElect?	735
:DISPlay:PVTime:VIEW[:SElect] ALL BOTH	735
:DISPlay:PVTime:VIEW[:SElect]?	735
:DISPlay:SEMAsk:VIEW[1]:WINDow[1]:TRACe:X[:SCALe]:COUPlE 0 1 OFF ON	644

List of Commands

:DISPlay:SEMAsk:VIEW[1]:WINDow[1]:TRACe:X[:SCALe]:COUPlE?	644
:DISPlay:SEMAsk:VIEW[1]:WINDow[1]:TRACe:X[:SCALe]:PDIVision <freq>	643
:DISPlay:SEMAsk:VIEW[1]:WINDow[1]:TRACe:X[:SCALe]:PDIVision ?	643
:DISPlay:SEMAsk:VIEW[1]:WINDow[1]:TRACe:X[:SCALe]:RLEVel <freq>	642
:DISPlay:SEMAsk:VIEW[1]:WINDow[1]:TRACe:X[:SCALe]:RLEVel?	642
:DISPlay:SEMAsk:VIEW[1]:WINDow[1]:TRACe:X[:SCALe]:RPOSition LEFT CENTer RIGHt	643
:DISPlay:SEMAsk:VIEW[1]:WINDow[1]:TRACe:X[:SCALe]:RPOSition?	643
:DISPlay:SEMAsk:VIEW[1]:WINDow[1]:TRACe:Y[:SCALe]:COUPlE 0 1 ON OFF	574
:DISPlay:SEMAsk:VIEW[1]:WINDow[1]:TRACe:Y[:SCALe]:COUPlE?	574
:DISPlay:SEMAsk:VIEW[1]:WINDow[1]:TRACe:Y[:SCALe]:PDIVision <rel_amp>	572
:DISPlay:SEMAsk:VIEW[1]:WINDow[1]:TRACe:Y[:SCALe]:PDIVision?	572
:DISPlay:SEMAsk:VIEW[1]:WINDow[1]:TRACe:Y[:SCALe]:RLEVel <real>	571
:DISPlay:SEMAsk:VIEW[1]:WINDow[1]:TRACe:Y[:SCALe]:RLEVel?	571
:DISPlay:SEMAsk:VIEW[1]:WINDow[1]:TRACe:Y[:SCALe]:RPOSition TOP CENTer BOTTom	573
:DISPlay:SEMAsk:VIEW[1]:WINDow[1]:TRACe:Y[:SCALe]:RPOSition?	573
:DISPlay:SEMAsk:VIEW:NSElect <integer>	653
:DISPlay:SEMAsk:VIEW:NSElect?	653
:DISPlay:SEMAsk:VIEW[:SElect] APFRReq RPFReq IPOWER CINformation	652
:DISPlay:SEMAsk:VIEW[:SElect]?	652
:DISPlay:THEMe TDColor TDMonochrome FCOLor FMONochrome	1755
:DISPlay:THEMe?	1755
:DISPlay:WINDow[1]:ANNotation[:ALL] OFF ON 0 1	1755
:DISPlay:WINDow[1]:ANNotation[:ALL]?	1755
:DISPlay:WINDow[1]:TRACe:GRATicule:GRID[:STATe] OFF ON 0 1	1753
:DISPlay:WINDow[1]:TRACe:GRATicule:GRID[:STATe]?	1753
:DISPlay:WINDow[1]:TRACe:Y:DLINe <ampl>	1754
:DISPlay:WINDow[1]:TRACe:Y:DLINe?	1754
:DISPlay:WINDow[1]:TRACe:Y:DLINe:STATe OFF ON 0 1	1754
:DISPlay:WINDow[1]:TRACe:Y:DLINe:STATe?	1754
:DISPlay:WINDow[1]:TRACe:Y[:SCALe]:NRLevel <rel_amp>	1696
:DISPlay:WINDow[1]:TRACe:Y[:SCALe]:NRLevel?	1696

List of Commands

:DISPlay:WINDow[1]:TRACe:Y[:SCALe]:NRPosition <integer>	1697
:DISPlay:WINDow[1]:TRACe:Y[:SCALe]:NRPosition?	1697
:DISPlay:WINDow[1]:TRACe:Y[:SCALe]:PDIVision <rel_ampl>	1240
:DISPlay:WINDow[1]:TRACe:Y[:SCALe]:PDIVision?	1240
:DISPlay:WINDow[1]:TRACe:Y[:SCALe]:RLEVel <real>.	1221
:DISPlay:WINDow[1]:TRACe:Y[:SCALe]:RLEVel?	1221
:DISPlay:WINDow[1]:TRACe:Y[:SCALe]:RLEVel:OFFSet <rel_ampl>.	1251
:DISPlay:WINDow[1]:TRACe:Y[:SCALe]:RLEVel:OFFSet?	1251
:DISPlay:WINDow[1]:TRACe:Y[:SCALe]:SPACing LINear LOGarithmic	1241
:DISPlay:WINDow[1]:TRACe:Y[:SCALe]:SPACing?	1241
:DISPlay:WINDow:FORMat:TILE	171
:DISPlay:WINDow:FORMat:ZOOM	171
:DISPlay:WINDow:MAMarker:POSition LEFT RIGHT.	1385
:DISPlay:WINDow:MAMarker:POSition?	1385
:DISPlay:WINDow:MAMarker[:STATe] ON OFF 1 0	1385
:DISPlay:WINDow:MAMarker[:STATe]?	1385
:DISPlay:WINDow[:SElect] <number>.	171
:DISPlay:WINDow[:SElect]?	171
*ESE <integer>	186
*ESE?	186
*ESR?	186
:FEED:RF:PORT:OUTP RFIO1	1311
:FETCh:<meas>[n]?	1895
:FETCh:ACP[n]?	457
:FETCh:CEVM[n]?	1179
:FETCh:CHPower:CHPower?	333
:FETCh:CHPower:DENSity?	333
:FETCh:CHPower[n]?	333
:FETCh:EVM[n]?	747
:FETCh:FCAPture?	1912
:FETCh:OBWidth:FERRor?	399

List of Commands

:FETCh:OBWidth[n]?	399
:FETCh:OBWidth:OBWidth?	399
:FETCh:OBWidth:XDB?	399
:FETCh:PVTime[n]?	679
:FETCh:SEMask[n]?	553
:FORMat:BORDER NORMAl SWAPped	1409
:FORMat:BORDER NORMAl SWAPped	1702
:FORMat:BORDER?	1409
:FORMat:BORDER?	1702
:FORMat[:TRACe][:DATA] ASCii INTEger,32 REAL,32 REAL,64.	1407
:FORMat[:TRACe][:DATA] ASCii INTEger,32 REAL,32 REAL,64.	1701
:FORMat[:TRACe][:DATA]?	1407
:FORMat[:TRACe][:DATA]?	1701
:GLOBal:FREQuency:CENTer[:STATe] 1 0 ON OFF.	1465
:GLOBal:FREQuency:CENTer[:STATe]?	1465
:HCOPY:ABORT.	203
:HCOPY[:IMMEDIATE].	203
*IDN?	187
:INIT.	148
:INITiate:ACP	457
:INITiate:CEVM.	1179
:INITiate:CHPower	333
:INITiate:CONTInuous OFF ON 0 1	1272
:INITiate:CONTInuous?	1272
:INITiate:EVM.	747
:INITiate:FCAPture	1910
:INITiate[:IMMEDIATE]	1489
:INITiate:OBWidth.	399
:INITiate:PAUse.	1651
:INITiate:PVTime.	679
:INITiate:REStart.	1489

List of Commands

:INITiate:RESume	1651
:INITiate:SEMask	553
:INPut:MIXer EXTernal INTernal	1283
:INPut:MIXer?	1283
:INSTrument:CATalog?	1457
:INSTrument:COUPle:DEFault	1466
:INSTrument:COUPle:FREQuency:CENTer ALL NONE	1465
:INSTrument:COUPle:FREQuency:CENTer?	1465
:INSTrument:DEFault	200
:INSTrument:NSElect <integer>	1456
:INSTrument:NSElect?	1456
:INSTrument[:SElect] SEQAN BASIC WCDMA EDGE GSM WIMAX OFDMA ADEMOD BTooth TDSCDMA CDMA2K CDMA1XEV LTE LTETDD	1454
:INSTrument[:SElect]?	1454
:MEASure:ACP[n]?	457
:MEASure:CEVM[n]?	1179
:MEASure:CHPower:CHPower?	333
:MEASure:CHPower:DENSity?	333
:MEASure:CHPower[n]?	333
:MEASure:EVM[n]?	747
:MEASure:OBWidth:FERRor?	399
:MEASure:OBWidth[n]?	399
:MEASure:OBWidth:OBWidth?	399
:MEASure:OBWidth:XDB?	399
:MEASure:PVTime[n]?	679
:MEASure:SEMask[n]?	553
:MEMMory:RDIRectory <directory_name>	236
:MEMory[:SOURce]	1632
:MEMory[:SOURce]:DATA <file_name>, <data>	1633
:MEMory[:SOURce]:DATA:APPend <file_name>, <data>	1633
:MMEMory:CATalog? [<directory_name>]	234

List of Commands

:MMEMory:CDIRectory [<directory_name>].	234
:MMEMory:CDIRectory?	234
:MMEMory:COpy <string>,<string>[,<string>,<string>]	234
:MMEMory:DATA <file_name>,<data>	235
:MMEMory:DATA? <file_name>	235
:MMEMory:DELeTe <file_name>[,<directory_name>]	235
:MMEMory:HEADer:ID? “<file name>”	1580
:MMEMory:LOAD:EVMSetup <string>.	1488
:MMEMory:LOAD:MASK <string>.	1487
:MMEMory:LOAD:SEQuences: SLISt ALISt SAALISt "MySequence.txt"	215
:MMEMory:LOAD:SSSetup <string>.	1485
:MMEMory:LOAD:STATe <filename>.	207
:MMEMory:LOAD:TRACe TRACE1 TRACE2 TRACE3 TRACE4 TRACE5 TRACE6,<filename>	213
:MMEMory:LOAD:TRACe:DATA D1 D2 D3 D4 D5 D6,<filename>[,<CSV TXT SDF MAT4 MAT HDF5 BIN>]	1812
:MMEMory:LOAD:TRACe:REGISter TRACE1 TRACE2 TRACE3 TRACE4 TRACE5 TRACE6,<integer>	213
:MMEMory:LOAD:VSASetup <string>	1486
:MMEMory:MDIRectory <directory_name>	236
:MMEMory:MOVE <string>,<string>[,<string>,<string>]	236
:MMEMory:REGISter:STATe:LABel <reg number>,"label"	222
:MMEMory:REGISter:STATe:LABel? <reg number>.	222
:MMEMory:STORE:CORRection 1 2 3 4 5 6, <filename>	1490
:MMEMory:STORE:MPADapter:CORRection 1 2 3 4 5 6 7 8 9 10 11 12 13 14 15 16, <filename>	1494
:MMEMory:STORE:RESuLts <string>.	376
:MMEMory:STORE:RESuLts <string>.	434
:MMEMory:STORE:RESuLts <string>.	629
:MMEMory:STORE:SCReen <filename>	231
:MMEMory:STORE:SCReen:THEMe TDCoLor TDMonochrome FCOLor FMONochrome	231
:MMEMory:STORE:SCReen:THEMe?	231
:MMEMory:STORE:STATe <filename>	219
:MMEMory:STORE:TRACe TRACE1 TRACE2 TRACE3 TRACE4 TRACE5 TRACE6 ALL,<filename>	224

List of Commands

:MMEMory:STORe:TRACe:DATA TRACE1 TRACE2 TRACE3 TRACE4 TRACE5 TRACE6,"<filena- me>"[,CSV TXT SDF MAT4 MAT HDF5 BIN[,OFF ON 0 1]].	1815
:MMEMory:STORe:TRACe:REGister TRACE1 TRACE2 TRACE3 TRACE4 TRACE5 TRACE6 ALL,<integer> 224	
:MMEM:STOR:SEQuences: SLISt ALISt SAALISt SSTep "MySequence.txt"	226
:MPAD:PORT:INP RFIO1	1314
*OPC?	187
*OPC	187
*OPT?.	188
:OUTPut:ANALog OFF SVIDeo LOGVideo LINVideo DAUDio	1349
:OUTPut:ANALog?	1349
:OUTPut:ANALog:AUTO OFF ON 0 1	1350
:OUTPut:ANALog:AUTO?	1350
:OUTPut[:EXTernal][:STATe] ON OFF 1 0	1498
:OUTPut[:EXTernal][:STATe]?	1498
:OUTPut:MODulation[:STATe] ON OFF 1 0	1503
:OUTPut:MODulation[:STATe]?	1503
*RCL <register #>	189
:READ:<meas>[n]?	1895
:READ:ACP[n]?	457
:READ:CEVM[n]?	1179
:READ:CHPower:CHPower?	333
:READ:CHPower:DENSity	333
:READ:CHPower[n]?	333
:READ:EVM[n]?	747
:READ:OBWidth:FERRor?	399
:READ:OBWidth[n]?	399
:READ:OBWidth:OBWidth?	399
:READ:OBWidth:XDB?	399
:READ:PVTime[n]?	679
:READ:SEMAsk[n]?	553
*RST	202

List of Commands

*SAV <register #>	189
[[:SENSe]:<meas>:AVERAge:COUNT <integer>	1801
[[:SENSe]:<meas>:AVERAge:COUNT?	1801
[[:SENSe]:<meas>:AVERAge:FAST OFF ON 0 1	1804
[[:SENSe]:<meas>:AVERAge:FAST?	1804
[[:SENSe]:<meas>:AVERAge:FAST:URATe <integer>	1805
[[:SENSe]:<meas>:AVERAge:FAST:URATe?	1805
[[:SENSe]:<meas>:AVERAge:FAST:URATe:AUTO OFF ON 0 1	1805
[[:SENSe]:<meas>:AVERAge:FAST:URATe:AUTO?	1805
[[:SENSe]:<meas>:AVERAge[:STATe] OFF ON 0 1	1801
[[:SENSe]:<meas>:AVERAge[:STATe]?	1801
[[:SENSe]:<meas>:AVERAge:TCONtrol EXPONential REPeat	1802
[[:SENSe]:<meas>:AVERAge:TCONtrol?	1802
[[:SENSe]:<meas>:AVERAge:TYPE RMS TIME MAXimum	1803
[[:SENSe]:<meas>:AVERAge:TYPE?	1803
[[:SENSe]:<meas>:BANDwidth BWIDth[:RESolution] <bandwidth>	1767
[[:SENSe]:<meas>:BANDwidth BWIDth[:RESolution]?	1767
[[:SENSe]:<meas>:BANDwidth BWIDth[:RESolution]:COUple SPAN MIN FIXed	1769
[[:SENSe]:<meas>:BANDwidth BWIDth[:RESolution]:COUple?	1769
[[:SENSe]:<meas>:FFT:WINDow[:TYPE] UNIFORM HANNing GAUSSian FLATtop	1770
[[:SENSe]:<meas>:FFT:WINDow[:TYPE]?	1770
[[:SENSe]:<meas>:FREQuency:SYNTHeSis[:STATe] 1 2	1805
[[:SENSe]:<meas>:FREQuency:SYNTHeSis[:STATe]?	1805
[[:SENSe]:<meas>:PUPDate:ENABle OFF ON 0 1	1914
[[:SENSe]:<meas>:PUPDate:ENABle?	1914
[[:SENSe]:<meas>:SWEep:EGATe:DELay <time>	1829
[[:SENSe]:<meas>:SWEep:EGATe:DELay?	1829
[[:SENSe]:<meas>:SWEep:EGATe[:SPAN] <time>	1829
[[:SENSe]:<meas>:SWEep:EGATe[:SPAN]?	1829
[[:SENSe]:<meas>:SWEep:EGATe:STATe OFF ON 0 1	1828
[[:SENSe]:<meas>:SWEep:EGATe:STATe?	1828

List of Commands

[::SENSe]:<meas>:SWEep:ISRate?	1913
[::SENSe]:<meas>:SWEep:POINts <integer>	1830
[::SENSe]:<meas>:SWEep:POINts?	1830
[::SENSe]:<meas>:SWEep:POINts:AUTO OFF ON 0 1	1830
[::SENSe]:<meas>:SWEep:POINts:AUTO?	1830
[::SENSe]:<meas>:SWEep:TIME <time>	1827
[::SENSe]:<meas>:SWEep:TIME?	1827
[::SENSe]:ACPower:AVERage:COUNt <integer>	486
[::SENSe]:ACPower:AVERage:COUNt?	486
[::SENSe]:ACPower:AVERage[:STATe] OFF ON 0 1	486
[::SENSe]:ACPower:AVERage[:STATe]?	486
[::SENSe]:ACPower:AVERage:TCONtrol EXPONential REPeat.	487
[::SENSe]:ACPower:AVERage:TCONtrol?	487
[::SENSe]:ACPower:BANDwidth[:RESolution] <bandwidth>	469
[::SENSe]:ACPower:BANDwidth[:RESolution]?	469
[::SENSe]:ACPower:BANDwidth[:RESolution]:AUTO ON OFF 1 0.	469
[::SENSe]:ACPower:BANDwidth[:RESolution]:AUTO?	469
[::SENSe]:ACPower:BANDwidth:SHAPE GAUSSian FLATtop.	472
[::SENSe]:ACPower:BANDwidth:SHAPE?	472
[::SENSe]:ACPower:BANDwidth:TYPE DB3 DB6	472
[::SENSe]:ACPower:BANDwidth:TYPE?	472
[::SENSe]:ACPower:BANDwidth:VIDeo <freq>	470
[::SENSe]:ACPower:BANDwidth:VIDeo?	470
[::SENSe]:ACPower:BANDwidth:VIDeo:AUTO OFF ON 0 1	470
[::SENSe]:ACPower:BANDwidth:VIDeo:AUTO?	470
[::SENSe]:ACPower:CARRier[1] 2:AUTO[:STATe] OFF ON 0 1.	491
[::SENSe]:ACPower:CARRier[1] 2:AUTO[:STATe]?	491
[::SENSe]:ACPower:CARRier[1] 2:COUNt <integer>	488
[::SENSe]:ACPower:CARRier[1] 2:COUNt?	488
[::SENSe]:ACPower:CARRier[1] 2:CPSD <real>	492
[::SENSe]:ACPower:CARRier[1] 2:CPSD?	492

List of Commands

[[:SENSe]:ACPower:CARRier[1] 2:LIST:BANDwidth[:INTegration] <freq>, ...	496
[[:SENSe]:ACPower:CARRier[1] 2:LIST:BANDwidth[:INTegration]?	496
[[:SENSe]:ACPower:CARRier[1] 2:LIST:COUPle OFF ON 0 1, OFF ON 0 1, OFF ON 0 1, OFF ON 0 1, OFF ON 0 1, OFF ON 0 1	493
[[:SENSe]:ACPower:CARRier[1] 2:LIST:COUPle?	493
[[:SENSe]:ACPower:CARRier[1] 2:LIST:FILTer:ALPHa <real>, ...	498
[[:SENSe]:ACPower:CARRier[1] 2:LIST:FILTer:ALPHa?	498
[[:SENSe]:ACPower:CARRier[1] 2:LIST:FILTer[:RRC][:STATe] ON OFF 1 0, ...	497
[[:SENSe]:ACPower:CARRier[1] 2:LIST:FILTer[:RRC][:STATe]?	497
[[:SENSe]:ACPower:CARRier[1] 2:LIST:METHod IBW RRC, ...	524
[[:SENSe]:ACPower:CARRier[1] 2:LIST:METHod?	524
[[:SENSe]:ACPower:CARRier[1] 2:LIST:PPResent YES NO, ...	494
[[:SENSe]:ACPower:CARRier[1] 2:LIST:PPResent?.	494
[[:SENSe]:ACPower:CARRier[1] 2:LIST:WIDTh <bandwidth>, ...	495
[[:SENSe]:ACPower:CARRier[1] 2:LIST:WIDTh?	495
[[:SENSe]:ACPower:CARRier[1] 2[:POWer] <real>	491
[[:SENSe]:ACPower:CARRier[1] 2[:POWer]?.	491
[[:SENSe]:ACPower:CARRier[1] 2:RCARrier <integer>	489
[[:SENSe]:ACPower:CARRier[1] 2:RCARrier?.	489
[[:SENSe]:ACPower:CARRier[1] 2:RCARrier:AUTO OFF ON 0 1	489
[[:SENSe]:ACPower:CARRier[1] 2:RCARrier:AUTO?.	489
[[:SENSe]:ACPower:CARRier[1] 2:RCFRequency <freq>	489
[[:SENSe]:ACPower:CARRier[1] 2:RCFRequency?.	489
[[:SENSe]:ACPower:CARRier[1] 2:RCFRequency:AUTO OFF ON 0 1	489
[[:SENSe]:ACPower:CARRier[1] 2:RCFRequency:AUTO?.	489
[[:SENSe]:ACPower:CORRection:NOISe[:AUTO] OFF ON 0 1	521
[[:SENSe]:ACPower:CORRection:NOISe[:AUTO]?.	521
[[:SENSe]:ACPower:DETEctor:AUTO ON OFF 1 0	546
[[:SENSe]:ACPower:DETEctor:AUTO?.	546
[[:SENSe]:ACPower:DETEctor[:FUNction] AVERAge NEGAtive NORMAl POSitive SAMPle	546
[[:SENSe]:ACPower:DETEctor[:FUNction]?.	546

List of Commands

[[:SENSe]:ACPower:FILTer[:RRC]:ALPHa <real>	523
[[:SENSe]:ACPower:FILTer[:RRC]:ALPHa?	523
[[:SENSe]:ACPower:FILTer[:RRC][:STATe] OFF ON 0 1	523
[[:SENSe]:ACPower:FILTer[:RRC][:STATe]?	523
[[:SENSe]:ACPower:FREQuency:SPAN <freq>	536
[[:SENSe]:ACPower:FREQuency:SPAN?	536
[[:SENSe]:ACPower:FREQuency:SPAN:FULL	537
[[:SENSe]:ACPower:FREQuency:SPAN:PREVious	537
[[:SENSe]:ACPower:FREQuency:SYNThesis:AUTO[:STATe] OFF ON 0 1	516
[[:SENSe]:ACPower:FREQuency:SYNThesis:AUTO[:STATe]?	516
[[:SENSe]:ACPower:FREQuency:SYNThesis[:STATe] 1 2 3	517
[[:SENSe]:ACPower:FREQuency:SYNThesis[:STATe]?	517
[[:SENSe]:ACPower:METHod IBW IBWRange FAST RBW	518
[[:SENSe]:ACPower:METHod?	518
[[:SENSe]:ACPower:OFFSet[1] 2:LIST:ABSolute <real>, <real>, <real>, <real>, <real>, <real>	507
[[:SENSe]:ACPower:OFFSet[1] 2:LIST:ABSolute?	507
[[:SENSe]:ACPower:OFFSet[1] 2:LIST:BANDwidth[:INTegration] <bandwidth>, <bandwidth>, <bandwidth>, <bandwidth>, <bandwidth>, <bandwidth>	502
[[:SENSe]:ACPower:OFFSet[1] 2:LIST:BANDwidth[:INTegration]?	502
[[:SENSe]:ACPower:OFFSet[1] 2:LIST:BANDwidth:RESolution <bandwidth>, <bandwidth>, <bandwidth>, <bandwidth>, <bandwidth>, <bandwidth>	503
[[:SENSe]:ACPower:OFFSet[1] 2:LIST:BANDwidth:RESolution?	503
[[:SENSe]:ACPower:OFFSet[1] 2:LIST:BANDwidth:RESolution:AUTO ON OFF 1 0, ON OFF 1 0, ON OFF 1 0, ON OFF 1 0, ON OFF 1 0, ON OFF 1 0	503
[[:SENSe]:ACPower:OFFSet[1] 2:LIST:BANDwidth:RESolution:AUTO?	503
[[:SENSe]:ACPower:OFFSet[1] 2:LIST:BANDwidth:SHApe GAUSSian FLATtop, GAUSSian FLATtop, GAUSSian FLATtop, GAUSSian FLATtop, GAUSSian FLATtop, GAUSSian FLATtop	506
[[:SENSe]:ACPower:OFFSet[1] 2:LIST:BANDwidth:SHApe?	506
[[:SENSe]:ACPower:OFFSet[1] 2:LIST:BANDwidth:TYPE DB3 DB6, DB3 DB6, DB3 DB6, DB3 DB6, DB3 DB6, DB3 DB6	506
[[:SENSe]:ACPower:OFFSet[1] 2:LIST:BANDwidth:TYPE?	506
[[:SENSe]:ACPower:OFFSet[1] 2:LIST:BANDwidth:VIDeo <freq>, <freq>, <freq>, <freq>, <freq>, <freq>	504
[[:SENSe]:ACPower:OFFSet[1] 2:LIST:BANDwidth:VIDeo?	504

List of Commands

[[:SENSe]:ACPower:OFFSet[1] 2:LIST:BANDwidth:VIDeo:AUTO OFF ON 0 1, OFF ON 0 1, OFF ON 0 1, OFF ON 0 1, OFF ON 0 1, OFF ON 0 1	504
[[:SENSe]:ACPower:OFFSet[1] 2:LIST:BANDwidth:VIDeo:AUTO?	504
[[:SENSe]:ACPower:OFFSet[1] 2:LIST:FILTer:ALPHa <real>, <real>, <real>, <real>, <real>, <real>	514
[[:SENSe]:ACPower:OFFSet[1] 2:LIST:FILTer:ALPHa?	514
[[:SENSe]:ACPower:OFFSet[1] 2:LIST:FILTer[:RRC][:STATe] ON OFF 1 0, ON OFF 1 0, ON OFF 1 0, ON OFF 1 0, ON OFF 1 0, ON OFF 1 0	513
[[:SENSe]:ACPower:OFFSet[1] 2:LIST:FILTer[:RRC][:STATe]?	513
[[:SENSe]:ACPower:OFFSet[1] 2:LIST[:FREQuency] <freq>, <freq>, <freq>, <freq>, <freq>, <freq>	500
[[:SENSe]:ACPower:OFFSet[1] 2:LIST[:FREQuency]?	500
[[:SENSe]:ACPower:OFFSet[1] 2:LIST:RCARrier <real>, <real>, <real>, <real>, <real>, <real>	508
[[:SENSe]:ACPower:OFFSet[1] 2:LIST:RCARrier?	508
[[:SENSe]:ACPower:OFFSet[1] 2:LIST:RPSDensity <rel_ampl>, <rel_ampl>, <rel_ampl>, <rel_ampl>, <rel_ampl>, <rel_ampl>.	511
[[:SENSe]:ACPower:OFFSet[1] 2:LIST:RPSDensity?	511
[[:SENSe]:ACPower:OFFSet[1] 2:LIST:SIDE NEGative BOTH POSitive,NEGative BOTH POSitive,NEGative BOTH POSitive,NEGative BOTH POSitive,NEGative BOTH POSitive,NEGative BOTH POSitive.	513
[[:SENSe]:ACPower:OFFSet[1] 2:LIST:SIDE?	513
[[:SENSe]:ACPower:OFFSet[1] 2:LIST:STATe OFF ON 0 1, OFF ON 0 1, OFF ON 0 1, OFF ON 0 1, OFF ON 0 1, OFF ON 0 1.	500
[[:SENSe]:ACPower:OFFSet[1] 2:LIST:STATe?	500
[[:SENSe]:ACPower:OFFSet[1] 2:LIST:TEST ABSolute AND OR RELative, ABSolute AND OR RELative, ABSolute AND OR RELative, ABSolute AND OR RELative, ABSolute AND OR RELative, ABSolute AND OR RELative, ABSolute AND OR RELative	512
[[:SENSe]:ACPower:OFFSet[1] 2:LIST:TEST?	512
[[:SENSe]:ACPower:OFFSet[1] 2:TYPE CTOCenter CTOEdge ETOCenter ETOEdge	515
[[:SENSe]:ACPower:OFFSet[1] 2:TYPE?	515
[[:SENSe]:ACPower:SWEep:POINts <integer>.	541
[[:SENSe]:ACPower:SWEep:POINts?	541
[[:SENSe]:ACPower:SWEep:TIME <time>.	538
[[:SENSe]:ACPower:SWEep:TIME?	538
[[:SENSe]:ACPower:SWEep:TIME:AUTO OFF ON 0 1	538
[[:SENSe]:ACPower:SWEep:TIME:AUTO?	538

List of Commands

[[:SENSe]:ACPower:SWEEP:TIME:AUTO:RULES NORMAl ACCuracy	540
[[:SENSe]:ACPower:SWEEP:TIME:AUTO:RULES?.	540
[[:SENSe]:ACPower:TYPE TPreF]PSDRef	519
[[:SENSe]:ACPower:TYPE?.	519
[[:SENSe]:ADC:DITHer:AUTO[:STATe] OFF ON 0 1	1442
[[:SENSe]:ADC:DITHer:AUTO[:STATe]?.	1442
[[:SENSe]:ADC:DITHer[:STATe] OFF ON HIGH.	1441
[[:SENSe]:ADC:DITHer[:STATe]?.	1441
[[:SENSe]:AVERage:CLear	1410
[[:SENSe]:AVERage:COUNt <integer>	1410
[[:SENSe]:AVERage:COUNt?	1410
[[:SENSe]:AVERage:TYPE RMS LOG SCALar [:SENSe]:AVERage:TYPE?	1411
[[:SENSe]:AVERage:TYPE:AUTO OFF ON 0 1	1411
[[:SENSe]:AVERage:TYPE:AUTO?	1411
[[:SENSe]:BANDwidth BWIDth[:RESolution] <freq>	1261
[[:SENSe]:BANDwidth BWIDth[:RESolution]?	1261
[[:SENSe]:BANDwidth BWIDth[:RESolution]:AUTO OFF ON 0 1	1261
[[:SENSe]:BANDwidth BWIDth[:RESolution]:AUTO?	1261
[[:SENSe]:BANDwidth BWIDth:SHAPE GAUSSian FLATtop	1267
[[:SENSe]:BANDwidth BWIDth:SHAPE?	1267
[[:SENSe]:BANDwidth BWIDth:TYPE DB3 DB6 IMPulse NOISe	1269
[[:SENSe]:BANDwidth BWIDth:TYPE?	1269
[[:SENSe]:BANDwidth BWIDth:VIDeo <freq>	1263
[[:SENSe]:BANDwidth BWIDth:VIDeo?	1263
[[:SENSe]:BANDwidth BWIDth:VIDeo:AUTO OFF ON 0 1	1263
[[:SENSe]:BANDwidth BWIDth:VIDeo:AUTO?	1263
[[:SENSe]:BANDwidth BWIDth:VIDeo:RATio <real>	1264
[[:SENSe]:BANDwidth BWIDth:VIDeo:RATio?	1264
[[:SENSe]:BANDwidth BWIDth:VIDeo:RATio:AUTO OFF ON 0 1	1264
[[:SENSe]:BANDwidth BWIDth:VIDeo:RATio:AUTO?	1264
[[:SENSe]:CEVM:DLINK:RESult ON OFF 0 1,	1198

List of Commands

[[:SENSe]:CEVM:DLINK:RESult?	1198
[[:SENSe]:CEVM:EVM:COPY[:IMMediate].	1196
[[:SENSe]:CEVM:IFBW <freq>	1185
[[:SENSe]:CEVM:IFBW?	1185
[[:SENSe]:CEVM:METHod NORMAl FAST	1194
[[:SENSe]:CEVM:METHod?	1194
[[:SENSe]:CEVM:ULINK:RESult ON OFF 0 1,	1200
[[:SENSe]:CEVM:ULINK:RESult?	1200
[[:SENSe]:CHPower:AVERage:COUNT <integer>.	357
[[:SENSe]:CHPower:AVERage:COUNT?	357
[[:SENSe]:CHPower:AVERage[:STATe] ON OFF 1 0	357
[[:SENSe]:CHPower:AVERage[:STATe]?	357
[[:SENSe]:CHPower:AVERage:TCONtrol EXPonential REPeat	358
[[:SENSe]:CHPower:AVERage:TCONtrol?	358
[[:SENSe]:CHPower:BANDwidth:INTegration <bandwidth>	359
[[:SENSe]:CHPower:BANDwidth:INTegration?	359
[[:SENSe]:CHPower:BANDwidth[:RESolution] <bandwidth>	341
[[:SENSe]:CHPower:BANDwidth[:RESolution]?	341
[[:SENSe]:CHPower:BANDwidth[:RESolution]:AUTO ON OFF 1 0	341
[[:SENSe]:CHPower:BANDwidth[:RESolution]:AUTO?	341
[[:SENSe]:CHPower:BANDwidth:SHAPE GAUSSian FLATtop	344
[[:SENSe]:CHPower:BANDwidth:SHAPE?	344
[[:SENSe]:CHPower:BANDwidth:VIDeo <bandwidth>	342
[[:SENSe]:CHPower:BANDwidth:VIDeo?.	342
[[:SENSe]:CHPower:BANDwidth:VIDeo:AUTO ON OFF 1 0	342
[[:SENSe]:CHPower:BANDwidth:VIDeo:AUTO?	342
[[:SENSe]:CHPower:DETEctor:AUTO ON OFF 1 0.	391
[[:SENSe]:CHPower:DETEctor:AUTO?	391
[[:SENSe]:CHPower:DETEctor[:FUNctIon] NORMAl AVERage POSitive SAMPlE NEGative	390
[[:SENSe]:CHPower:DETEctor[:FUNctIon]?	390
[[:SENSe]:CHPower:FILTer[:RRC]:ALPHa <real>	364

List of Commands

[[:SENSe]:CHPower:FILTer[:RRC]:ALPHA?]	364
[[:SENSe]:CHPower:FILTer[:RRC]:BANDwidth <real>]	365
[[:SENSe]:CHPower:FILTer[:RRC]:BANDwidth?]	365
[[:SENSe]:CHPower:FILTer[:RRC][:STATe] OFF ON 0 1]	363
[[:SENSe]:CHPower:FILTer[:RRC][:STATe]?]	363
[[:SENSe]:CHPower:FREQuency:SPAN <freq>]	382
[[:SENSe]:CHPower:FREQuency:SPAN?]	382
[[:SENSe]:CHPower:FREQuency:SPAN:FULL]	384
[[:SENSe]:CHPower:FREQuency:SPAN:PREVious]	384
[[:SENSe]:CHPower:FREQuency:SYNThesis:AUTO[:STATe] OFF ON 0 1]	361
[[:SENSe]:CHPower:FREQuency:SYNThesis:AUTO[:STATe]?]	361
[[:SENSe]:CHPower:FREQuency:SYNThesis[:STATe] 1 2 3]	361
[[:SENSe]:CHPower:FREQuency:SYNThesis[:STATe]?]	361
[[:SENSe]:CHPower:IF:GAIN:AUTO[:STATe] ON OFF 1 0]	362
[[:SENSe]:CHPower:IF:GAIN:AUTO[:STATe]?]	362
[[:SENSe]:CHPower:IF:GAIN[:STATe] ON OFF 1 0]	363
[[:SENSe]:CHPower:IF:GAIN[:STATe]?]	363
[[:SENSe]:CHPower:SWEEp:POINts <integer>]	388
[[:SENSe]:CHPower:SWEEp:POINts?]	388
[[:SENSe]:CHPower:SWEEp:TIME <time>]	385
[[:SENSe]:CHPower:SWEEp:TIME?]	385
[[:SENSe]:CHPower:SWEEp:TIME:AUTO OFF ON 0 1]	385
[[:SENSe]:CHPower:SWEEp:TIME:AUTO?]	385
[[:SENSe]:CHPower:SWEEp:TIME:AUTO:RULes NORMAl ACCuracy]	386
[[:SENSe]:CHPower:SWEEp:TIME:AUTO:RULes?]	386
[[:SENSe]:CORRection:BTS[:RF]:GAIN <rel_ampl>]	1291
[[:SENSe]:CORRection:BTS[:RF]:GAIN?]	1291
[[:SENSe]:CORRection:BTS[:RF]:LOSS <rel_ampl>]	1292
[[:SENSe]:CORRection:BTS[:RF]:LOSS?]	1292
[[:SENSe]:CORRection:CSET[1] 2 3 4 5 6:COMMeNt "text"]]	1299
[[:SENSe]:CORRection:CSET[1] 2 3 4 5 6:COMMeNt?]	1299

List of Commands

[[:SENSe]:CORRection:CSET[1] 2 3 4 5 6:DATA <freq>, <ampl>, ...	1306
[[:SENSe]:CORRection:CSET[1] 2 3 4 5 6:DATA?	1306
[[:SENSe]:CORRection:CSET[1] 2 3 4 5 6:DATA:MERGe <freq>, <ampl>, ...	1306
[[:SENSe]:CORRection:CSET[1] 2 3 4 5 6:DELeTe	1305
[[:SENSe]:CORRection:CSET[1] 2 3 4 5 6:DESCription "text"	1299
[[:SENSe]:CORRection:CSET[1] 2 3 4 5 6:DESCription?	1299
[[:SENSe]:CORRection:CSET[1] 2 3 4 5 6:RF:PORT RFIN RFIO1 RFIO2 RFOut.	1300
[[:SENSe]:CORRection:CSET[1] 2 3 4 5 6:RF:PORT?	1300
[[:SENSe]:CORRection:CSET[1] 2 3 4 5 6:RF:PORT:RFIO1 SOURce ANALyzer BOTH.	1301
[[:SENSe]:CORRection:CSET[1] 2 3 4 5 6:RF:PORT:RFIO1?	1301
[[:SENSe]:CORRection:CSET[1] 2 3 4 5 6:RF:PORT:RFIO2 SOURce ANALyzer BOTH.	1302
[[:SENSe]:CORRection:CSET[1] 2 3 4 5 6:RF:PORT:RFIO2?	1302
[[:SENSe]:CORRection:CSET[1] 2 3 4 5 6[:STATe] ON OFF 1 0	1296
[[:SENSe]:CORRection:CSET[1] 2 3 4 5 6[:STATe]?	1296
[[:SENSe]:CORRection:CSET[1] 2 3 4 5 6:X:SPACing LINear LOGarithmic.	1297
[[:SENSe]:CORRection:CSET[1] 2 3 4 5 6:X:SPACing?	1297
[[:SENSe]:CORRection:CSET:ALL:DELeTe	1305
[[:SENSe]:CORRection:CSET:ALL[:STATe] ON OFF 1 0	1305
[[:SENSe]:CORRection:CSET:ALL[:STATe]?	1305
[[:SENSe]:CORRection:FEQualizer OFF NORMal INVert	1469
[[:SENSe]:CORRection:FEQualizer?	1469
[[:SENSe]:CORRection:FEQualizer:REGister D1 D2 D3 D4 D5 D6.	1469
[[:SENSe]:CORRection:FEQualizer:REGister?	1469
[[:SENSe]:CORRection:IMPedance[:INPut][:MAGNitude] 50 75.	1285
[[:SENSe]:CORRection:IMPedance[:INPut][:MAGNitude]?	1285
[[:SENSe]:CORRection:MS[:RF]:GAIN <rel_ampl>.	1290
[[:SENSe]:CORRection:MS[:RF]:GAIN?	1290
[[:SENSe]:CORRection:MS[:RF]:LOSS <rel_ampl>.	1291
[[:SENSe]:CORRection:MS[:RF]:LOSS?	1291
[[:SENSe]:CORRection:SA[:RF]:GAIN <rel_ampl>.	1289
[[:SENSe]:CORRection:SA[:RF]:GAIN?	1289

List of Commands

[:SENSe]:DEMod AM FM PM OFF	1447
[:SENSe]:DEMod?.	1447
[:SENSe]:DEMod:AM:BANDwidth:CHANnel <freq>	1448
[:SENSe]:DEMod:AM:BANDwidth:CHANnel?	1448
[:SENSe]:DEMod:FM:BANDwidth:CHANnel <freq>.	1449
[:SENSe]:DEMod:FM:BANDwidth:CHANnel?.	1449
[:SENSe]:DEMod:FM:DEEMphasis OFF US25 US50 US75 US750.	1450
[:SENSe]:DEMod:FM:DEEMphasis?.	1450
[:SENSe]:DEMod:PM:BANDwidth:CHANnel <freq>.	1452
[:SENSe]:DEMod:PM:BANDwidth:CHANnel?.	1452
[:SENSe]:DEMod:STATe OFF ON 0 1	1453
[:SENSe]:DEMod:STATe?.	1453
[:SENSe]:DEMod:TIME <time>.	1453
[:SENSe]:DEMod:TIME?	1453
[:SENSe]:DETEctor:AUTO ON OFF 1 0.	1678
[:SENSe]:DETEctor:AUTO?	1678
[:SENSe]:DETEctor[:FUNctIon] NORMAl AVERAge POSitive SAMPlE NEGAtive QPEak EAVERage EPOSitive MPOSitive RMS	1675
[:SENSe]:DETEctor[:FUNctIon]?	1675
[:SENSe]:DETEctor:TRACe[1] 2 3 4 5 6 AVERAge NEGAtive NORMAl POSitive SAMPlE QPEak EAVERage RAVERage	1674
[:SENSe]:DETEctor:TRACe[1] 2 3 4 5 6?	1674
[:SENSe]:DETEctor:TRACe[1] 2 3 4 5 6:AUTO ON OFF 1 0.	1677
[:SENSe]:DETEctor:TRACe[1] 2 3 4 5 6:AUTO?	1677
[:SENSe]:EVM:DLINK:AENumber <integer>	1126
[:SENSe]:EVM:DLINK:AENumber?	1126
[:SENSe]:EVM:DLINK:AESPacing <double>	1126
[:SENSe]:EVM:DLINK:AESPacing?	1126
[:SENSe]:EVM:DLINK:DECode:DFINclude F1F1B F1F1D F1 F1B F1D [:SENSe]:EVM:DLINK:DECode:DFINclude?	1087
[:SENSe]:EVM:DLINK:DECode:DFTWo:PRFour <integer>	1094
[:SENSe]:EVM:DLINK:DECode:DFTWo:PRFour?	1094

List of Commands

[::SENSe]:EVM:DLINK:DECode:DFTWo:PRONe <integer>	1092
[::SENSe]:EVM:DLINK:DECode:DFTWo:PRONe?	1092
[::SENSe]:EVM:DLINK:DECode:DFTWo:PRTHree <integer>	1093
[::SENSe]:EVM:DLINK:DECode:DFTWo:PRTHree?	1093
[::SENSe]:EVM:DLINK:DECode:DFTWo:PRTWo <integer>	1092
[::SENSe]:EVM:DLINK:DECode:DFTWo:PRTWo?	1092
[::SENSe]:EVM:DLINK:DECode:PBCH NONE DESCrambled DRMatched DECoded	1081
[::SENSe]:EVM:DLINK:DECode:PBCH?	1081
[::SENSe]:EVM:DLINK:DECode:PCFich NONE DESCrambled DECoded	1082
[::SENSe]:EVM:DLINK:DECode:PCFich?	1082
[::SENSe]:EVM:DLINK:DECode:PDCCh NONE DEMapped DINterleaved DESCrambled DRMatched DECoded 1083	
[::SENSe]:EVM:DLINK:DECode:PDCCh?	1083
[::SENSe]:EVM:DLINK:DECode:PDSCh NONE DESCrambled DRMatched DCBLock DTBLock	1084
[::SENSe]:EVM:DLINK:DECode:PDSCh?	1084
[::SENSe]:EVM:DLINK:DECode:RNTI:MAXimum:RA <integer>	1089
[::SENSe]:EVM:DLINK:DECode:RNTI:MAXimum:RA?	1089
[::SENSe]:EVM:DLINK:DECode:RNTI:MAXimum:TPC <integer>	1091
[::SENSe]:EVM:DLINK:DECode:RNTI:MAXimum:TPC?	1091
[::SENSe]:EVM:DLINK:DECode:RNTI:MINimum:RA <integer>	1088
[::SENSe]:EVM:DLINK:DECode:RNTI:MINimum:RA?	1088
[::SENSe]:EVM:DLINK:DECode:RNTI:MINimum:TPC <integer>	1090
[::SENSe]:EVM:DLINK:DECode:RNTI:MINimum:TPC?	1090
[::SENSe]:EVM:DLINK:PDSCh:CSRatio R1 PB0 PB1 PB2 PB3	780
[::SENSe]:EVM:DLINK:PDSCh:CSRatio?	780
[::SENSe]:EVM:DLINK:PROFile:ADD:USER	907
[::SENSe]:EVM:DLINK:PROFile:AUTO[:DETect]:MODE POWer DECoded	791
[::SENSe]:EVM:DLINK:PROFile:AUTO[:DETect]:MODE?	791
[::SENSe]:EVM:DLINK:PROFile:AUTO[:DETect]:POWer OFF ON 0 1	792
[::SENSe]:EVM:DLINK:PROFile:AUTO[:DETect]:POWer?	792
[::SENSe]:EVM:DLINK:PROFile:AUTO[:DETect]:POWer:ROUNd OFF ON 0 1	792

List of Commands

[:SENSe]:EVM:DLINK:PROFile:AUTO[:DETECT]:POWer:ROUNd?	792
[:SENSe]:EVM:DLINK:PROFile:AUTO:PDSCh:CBINdex <integer>	914
[:SENSe]:EVM:DLINK:PROFile:AUTO:PDSCh:CBINdex?	914
[:SENSe]:EVM:DLINK:PROFile:AUTO:PDSCh:CDD WOCDD LDCDD	913
[:SENSe]:EVM:DLINK:PROFile:AUTO:PDSCh:CDD?	913
[:SENSe]:EVM:DLINK:PROFile:AUTO:PDSCh:NCODEwords <integer>	911
[:SENSe]:EVM:DLINK:PROFile:AUTO:PDSCh:NCODEwords?	911
[:SENSe]:EVM:DLINK:PROFile:AUTO:PDSCh:NLAYers <integer>	910
[:SENSe]:EVM:DLINK:PROFile:AUTO:PDSCh:NLAYers?	910
[:SENSe]:EVM:DLINK:PROFile:AUTO:PDSCh:PRECoding OFF TXDiversity SMULTiplex	909
[:SENSe]:EVM:DLINK:PROFile:AUTO:PDSCh:PRECoding?	909
[:SENSe]:EVM:DLINK:PROFile:AUTO:PDSCh:QAM16:CWONe:ENABle ON OFF 0 1	903
[:SENSe]:EVM:DLINK:PROFile:AUTO:PDSCh:QAM16:CWONe:ENABle?	903
[:SENSe]:EVM:DLINK:PROFile:AUTO:PDSCh:QAM16:CWONe:PWRBoost <rel_ampl>	894
[:SENSe]:EVM:DLINK:PROFile:AUTO:PDSCh:QAM16:CWONe:PWRBoost?	894
[:SENSe]:EVM:DLINK:PROFile:AUTO:PDSCh:QAM16:CWZero:ENABle ON OFF 0 1	900
[:SENSe]:EVM:DLINK:PROFile:AUTO:PDSCh:QAM16:CWZero:ENABle?	900
[:SENSe]:EVM:DLINK:PROFile:AUTO:PDSCh:QAM16:EPRE <rel_ampl>	888
[:SENSe]:EVM:DLINK:PROFile:AUTO:PDSCh:QAM16:EPRE?	888
[:SENSe]:EVM:DLINK:PROFile:AUTO:PDSCh:QAM16:PWRBoost <rel_ampl>	891
[:SENSe]:EVM:DLINK:PROFile:AUTO:PDSCh:QAM16:PWRBoost?	891
[:SENSe]:EVM:DLINK:PROFile:AUTO:PDSCh:QAM64:CWONe:ENABle ON OFF 0 1	903
[:SENSe]:EVM:DLINK:PROFile:AUTO:PDSCh:QAM64:CWONe:ENABle?	903
[:SENSe]:EVM:DLINK:PROFile:AUTO:PDSCh:QAM64:CWONe:PWRBoost <rel_ampl>	894
[:SENSe]:EVM:DLINK:PROFile:AUTO:PDSCh:QAM64:CWONe:PWRBoost?	894
[:SENSe]:EVM:DLINK:PROFile:AUTO:PDSCh:QAM64:CWZero:ENABle ON OFF 0 1	901
[:SENSe]:EVM:DLINK:PROFile:AUTO:PDSCh:QAM64:CWZero:ENABle?	901
[:SENSe]:EVM:DLINK:PROFile:AUTO:PDSCh:QAM64:EPRE <rel_ampl>	889
[:SENSe]:EVM:DLINK:PROFile:AUTO:PDSCh:QAM64:EPRE?	889
[:SENSe]:EVM:DLINK:PROFile:AUTO:PDSCh:QAM64:PWRBoost <rel_ampl>	892
[:SENSe]:EVM:DLINK:PROFile:AUTO:PDSCh:QAM64:PWRBoost?	892

List of Commands

[:SENSe]:EVM:DLINK:PROFile:AUTO:PDSCh:QPSK:CWONe:ENABle ON OFF 0 1	902
[:SENSe]:EVM:DLINK:PROFile:AUTO:PDSCh:QPSK:CWONe:ENABle?	902
[:SENSe]:EVM:DLINK:PROFile:AUTO:PDSCh:QPSK:CWONe:PWRBoost <rel_amp>	893
[:SENSe]:EVM:DLINK:PROFile:AUTO:PDSCh:QPSK:CWONe:PWRBoost?	893
[:SENSe]:EVM:DLINK:PROFile:AUTO:PDSCh:QPSK:CWZero:ENABle ON OFF 0 1	900
[:SENSe]:EVM:DLINK:PROFile:AUTO:PDSCh:QPSK:CWZero:ENABle?	900
[:SENSe]:EVM:DLINK:PROFile:AUTO:PDSCh:QPSK:EPRE <rel_amp>	888
[:SENSe]:EVM:DLINK:PROFile:AUTO:PDSCh:QPSK:EPRE?	888
[:SENSe]:EVM:DLINK:PROFile:AUTO:PDSCh:QPSK:PWRBoost <rel_amp>	890
[:SENSe]:EVM:DLINK:PROFile:AUTO:PDSCh:QPSK:PWRBoost?	890
[:SENSe]:EVM:DLINK:PROFile:AUTO:PMCH:PWRBoost <rel_amp>	837
[:SENSe]:EVM:DLINK:PROFile:AUTO:PMCH:PWRBoost?	837
[:SENSe]:EVM:DLINK:PROFile:CLear	919
[:SENSe]:EVM:DLINK:PROFile:COUNt?	919
[:SENSe]:EVM:DLINK:PROFile:EPRE:PANTenna OFF ON 0 1	855
[:SENSe]:EVM:DLINK:PROFile:EPRE:PANTenna?	855
[:SENSe]:EVM:DLINK:PROFile:EUSers:COUNt <integer>	793
[:SENSe]:EVM:DLINK:PROFile:EUSers:COUNt?	793
[:SENSe]:EVM:DLINK:PROFile:EXCLude:ALL	795
[:SENSe]:EVM:DLINK:PROFile:IGNore	919
[:SENSe]:EVM:DLINK:PROFile:INCLude:ALL	794
[:SENSe]:EVM:DLINK:PROFile:MBSFn INCLude EXCLude	800
[:SENSe]:EVM:DLINK:PROFile:MBSFn?	800
[:SENSe]:EVM:DLINK:PROFile:MBSFn:ACTive OFF ON 0 1	830
[:SENSe]:EVM:DLINK:PROFile:MBSFn:ACTive?	830
[:SENSe]:EVM:DLINK:PROFile:MBSFn:AID <integer>	830
[:SENSe]:EVM:DLINK:PROFile:MBSFn:AID?	830
[:SENSe]:EVM:DLINK:PROFile:MBSFn:NMRLength <integer>	831
[:SENSe]:EVM:DLINK:PROFile:MBSFn:NMRLength?	831
[:SENSe]:EVM:DLINK:PROFile:MBSFn:PWRBoost <rel_amp>	831
[:SENSe]:EVM:DLINK:PROFile:MBSFn:PWRBoost?	831

List of Commands

[:SENSe]:EVM:DLINK:PROFile:MBSFn:SUBFrame1:ACTive OFF ON 0 1	832
[:SENSe]:EVM:DLINK:PROFile:MBSFn:SUBFrame1:ACTive?	832
[:SENSe]:EVM:DLINK:PROFile:MBSFn:SUBFrame2:ACTive OFF ON 0 1	833
[:SENSe]:EVM:DLINK:PROFile:MBSFn:SUBFrame2:ACTive?	833
[:SENSe]:EVM:DLINK:PROFile:MBSFn:SUBFrame3:ACTive OFF ON 0 1	833
[:SENSe]:EVM:DLINK:PROFile:MBSFn:SUBFrame3:ACTive?	833
[:SENSe]:EVM:DLINK:PROFile:MBSFn:SUBFrame4:ACTive OFF ON 0 1	834
[:SENSe]:EVM:DLINK:PROFile:MBSFn:SUBFrame4:ACTive?	834
[:SENSe]:EVM:DLINK:PROFile:MBSFn:SUBFrame6:ACTive OFF ON 0 1	834
[:SENSe]:EVM:DLINK:PROFile:MBSFn:SUBFrame6:ACTive?	834
[:SENSe]:EVM:DLINK:PROFile:MBSFn:SUBFrame7:ACTive OFF ON 0 1	835
[:SENSe]:EVM:DLINK:PROFile:MBSFn:SUBFrame7:ACTive?	835
[:SENSe]:EVM:DLINK:PROFile:MBSFn:SUBFrame8:ACTive OFF ON 0 1	835
[:SENSe]:EVM:DLINK:PROFile:MBSFn:SUBFrame8:ACTive?	835
[:SENSe]:EVM:DLINK:PROFile:MBSFn:SUBFrame9:ACTive OFF ON 0 1	836
[:SENSe]:EVM:DLINK:PROFile:MBSFn:SUBFrame9:ACTive?	836
[:SENSe]:EVM:DLINK:PROFile:PBCH INCLude EXCLude	796
[:SENSe]:EVM:DLINK:PROFile:PBCH?	796
[:SENSe]:EVM:DLINK:PROFile:PBCH:PWRBoost <rel_ampl>	807
[:SENSe]:EVM:DLINK:PROFile:PBCH:PWRBoost?	807
[:SENSe]:EVM:DLINK:PROFile:PCFich INCLude EXCLude	797
[:SENSe]:EVM:DLINK:PROFile:PCFich?	797
[:SENSe]:EVM:DLINK:PROFile:PCFich:PWRBoost <rel_ampl>	808
[:SENSe]:EVM:DLINK:PROFile:PCFich:PWRBoost?	808
[:SENSe]:EVM:DLINK:PROFile:PDCCh INCLude EXCLude	799
[:SENSe]:EVM:DLINK:PROFile:PDCCh?	799
[:SENSe]:EVM:DLINK:PROFile:PDCCh:ALLocation:AUTO[:DETect] OFF ON 0 1	811
[:SENSe]:EVM:DLINK:PROFile:PDCCh:ALLocation:AUTO[:DETect]?	811
[:SENSe]:EVM:DLINK:PROFile:PDCCh:ALLocation:CONStant OFF ON 0 1	811
[:SENSe]:EVM:DLINK:PROFile:PDCCh:ALLocation:CONStant?	811
[:SENSe]:EVM:DLINK:PROFile:PDCCh:ALLocation:SUBFrame0:SYMBols <integer>	812

List of Commands

[[:SENSe]:EVM:DLINK:PROFile:PDCCh:ALLocation:SUBFrame0:SYMBOLS?	812
[[:SENSe]:EVM:DLINK:PROFile:PDCCh:ALLocation:SUBFrame1:SYMBOLS <integer>	813
[[:SENSe]:EVM:DLINK:PROFile:PDCCh:ALLocation:SUBFrame1:SYMBOLS?	813
[[:SENSe]:EVM:DLINK:PROFile:PDCCh:ALLocation:SUBFrame2:SYMBOLS <integer>	813
[[:SENSe]:EVM:DLINK:PROFile:PDCCh:ALLocation:SUBFrame2:SYMBOLS?	813
[[:SENSe]:EVM:DLINK:PROFile:PDCCh:ALLocation:SUBFrame3:SYMBOLS <integer>	814
[[:SENSe]:EVM:DLINK:PROFile:PDCCh:ALLocation:SUBFrame3:SYMBOLS?	814
[[:SENSe]:EVM:DLINK:PROFile:PDCCh:ALLocation:SUBFrame4:SYMBOLS <integer>	815
[[:SENSe]:EVM:DLINK:PROFile:PDCCh:ALLocation:SUBFrame4:SYMBOLS?	815
[[:SENSe]:EVM:DLINK:PROFile:PDCCh:ALLocation:SUBFrame5:SYMBOLS <integer>	815
[[:SENSe]:EVM:DLINK:PROFile:PDCCh:ALLocation:SUBFrame5:SYMBOLS?	815
[[:SENSe]:EVM:DLINK:PROFile:PDCCh:ALLocation:SUBFrame6:SYMBOLS <integer>	816
[[:SENSe]:EVM:DLINK:PROFile:PDCCh:ALLocation:SUBFrame6:SYMBOLS?	816
[[:SENSe]:EVM:DLINK:PROFile:PDCCh:ALLocation:SUBFrame7:SYMBOLS <integer>	817
[[:SENSe]:EVM:DLINK:PROFile:PDCCh:ALLocation:SUBFrame7:SYMBOLS?	817
[[:SENSe]:EVM:DLINK:PROFile:PDCCh:ALLocation:SUBFrame8:SYMBOLS <integer>	817
[[:SENSe]:EVM:DLINK:PROFile:PDCCh:ALLocation:SUBFrame8:SYMBOLS?	817
[[:SENSe]:EVM:DLINK:PROFile:PDCCh:ALLocation:SUBFrame9:SYMBOLS <integer>	818
[[:SENSe]:EVM:DLINK:PROFile:PDCCh:ALLocation:SUBFrame9:SYMBOLS?	818
[[:SENSe]:EVM:DLINK:PROFile:PDCCh:PWRBoost <rel_ampl>	809
[[:SENSe]:EVM:DLINK:PROFile:PDCCh:PWRBoost?	809
[[:SENSe]:EVM:DLINK:PROFile:PDCCh:PWRBoost:STEP <rel_ampl>	810
[[:SENSe]:EVM:DLINK:PROFile:PDCCh:PWRBoost:STEP?	810
[[:SENSe]:EVM:DLINK:PROFile:PHICH INCLude EXCLude	798
[[:SENSe]:EVM:DLINK:PROFile:PHICH?	798
[[:SENSe]:EVM:DLINK:PROFile:PHICH:ALLocation:RATio ADETECT R1BY6 R1BY2 R1 R2	822
[[:SENSe]:EVM:DLINK:PROFile:PHICH:ALLocation:RATio?	822
[[:SENSe]:EVM:DLINK:PROFile:PHICH:DESPread OFF ON 0 1	821
[[:SENSe]:EVM:DLINK:PROFile:PHICH:DESPread?	821
[[:SENSe]:EVM:DLINK:PROFile:PHICH:DURATION ADETECT NORMAl EXTended	824
[[:SENSe]:EVM:DLINK:PROFile:PHICH:DURATION?	824

List of Commands

[:SENSe]:EVM:DLINK:PROFile:PHICH:MIDefinition STD ETM	826
[:SENSe]:EVM:DLINK:PROFile:PHICH:MIDefinition?	826
[:SENSe]:EVM:DLINK:PROFile:PHICH:PWRBoost <rel_amp>	819
[:SENSe]:EVM:DLINK:PROFile:PHICH:PWRBoost?	819
[:SENSe]:EVM:DLINK:PROFile:PHICH:PWRBoost:STEP <rel_amp>+.	820
[:SENSe]:EVM:DLINK:PROFile:PHICH:PWRBoost:STEP?	820
[:SENSe]:EVM:DLINK:PROFile:PMCH INCLude EXCLude	800
[:SENSe]:EVM:DLINK:PROFile:PMCH?	800
[:SENSe]:EVM:DLINK:PROFile:PMCH:SUBFrame1:ACTive OFF ON 0 1	838
[:SENSe]:EVM:DLINK:PROFile:PMCH:SUBFrame1:ACTive?	838
[:SENSe]:EVM:DLINK:PROFile:PMCH:SUBFrame1:MODulation:TYPE QPSK QAM16 QAM64	848
[:SENSe]:EVM:DLINK:PROFile:PMCH:SUBFrame1:MODulation:TYPE?	848
[:SENSe]:EVM:DLINK:PROFile:PMCH:SUBFrame1:PWRBoost <rel_amp>	842
[:SENSe]:EVM:DLINK:PROFile:PMCH:SUBFrame1:PWRBoost?	842
[:SENSe]:EVM:DLINK:PROFile:PMCH:SUBFrame2:ACTive OFF ON 0 1	838
[:SENSe]:EVM:DLINK:PROFile:PMCH:SUBFrame2:ACTive?	838
[:SENSe]:EVM:DLINK:PROFile:PMCH:SUBFrame2:MODulation:TYPE QPSK QAM16 QAM64	848
[:SENSe]:EVM:DLINK:PROFile:PMCH:SUBFrame2:MODulation:TYPE?	848
[:SENSe]:EVM:DLINK:PROFile:PMCH:SUBFrame2:PWRBoost <rel_amp>	843
[:SENSe]:EVM:DLINK:PROFile:PMCH:SUBFrame2:PWRBoost?	843
[:SENSe]:EVM:DLINK:PROFile:PMCH:SUBFrame3:ACTive OFF ON 0 1	839
[:SENSe]:EVM:DLINK:PROFile:PMCH:SUBFrame3:ACTive?	839
[:SENSe]:EVM:DLINK:PROFile:PMCH:SUBFrame3:MODulation:TYPE QPSK QAM16 QAM64	849
[:SENSe]:EVM:DLINK:PROFile:PMCH:SUBFrame3:MODulation:TYPE?	849
[:SENSe]:EVM:DLINK:PROFile:PMCH:SUBFrame3:PWRBoost <rel_amp>	844
[:SENSe]:EVM:DLINK:PROFile:PMCH:SUBFrame3:PWRBoost?	844
[:SENSe]:EVM:DLINK:PROFile:PMCH:SUBFrame4:ACTive OFF ON 0 1	839
[:SENSe]:EVM:DLINK:PROFile:PMCH:SUBFrame4:ACTive?	839
[:SENSe]:EVM:DLINK:PROFile:PMCH:SUBFrame4:MODulation:TYPE QPSK QAM16 QAM64	849
[:SENSe]:EVM:DLINK:PROFile:PMCH:SUBFrame4:MODulation:TYPE?	849
[:SENSe]:EVM:DLINK:PROFile:PMCH:SUBFrame4:PWRBoost <rel_amp>	844

List of Commands

[::SENSe]:EVM:DLINK:PROFile:PMCH:SUBFrame4:PWRBoost?	844
[::SENSe]:EVM:DLINK:PROFile:PMCH:SUBFrame6:ACTive OFF ON 0 1	840
[::SENSe]:EVM:DLINK:PROFile:PMCH:SUBFrame6:ACTive?	840
[::SENSe]:EVM:DLINK:PROFile:PMCH:SUBFrame6:MODulation:TYPE QPSK QAM16 QAM64	850
[::SENSe]:EVM:DLINK:PROFile:PMCH:SUBFrame6:MODulation:TYPE?	850
[::SENSe]:EVM:DLINK:PROFile:PMCH:SUBFrame6:PWRBoost <rel_ampl>	845
[::SENSe]:EVM:DLINK:PROFile:PMCH:SUBFrame6:PWRBoost?	845
[::SENSe]:EVM:DLINK:PROFile:PMCH:SUBFrame7:ACTive OFF ON 0 1	841
[::SENSe]:EVM:DLINK:PROFile:PMCH:SUBFrame7:ACTive?	841
[::SENSe]:EVM:DLINK:PROFile:PMCH:SUBFrame7:MODulation:TYPE QPSK QAM16 QAM64	851
[::SENSe]:EVM:DLINK:PROFile:PMCH:SUBFrame7:MODulation:TYPE?	851
[::SENSe]:EVM:DLINK:PROFile:PMCH:SUBFrame7:PWRBoost <rel_ampl>	846
[::SENSe]:EVM:DLINK:PROFile:PMCH:SUBFrame7:PWRBoost?	846
[::SENSe]:EVM:DLINK:PROFile:PMCH:SUBFrame8:ACTive OFF ON 0 1	841
[::SENSe]:EVM:DLINK:PROFile:PMCH:SUBFrame8:ACTive?	841
[::SENSe]:EVM:DLINK:PROFile:PMCH:SUBFrame8:MODulation:TYPE QPSK QAM16 QAM64	851
[::SENSe]:EVM:DLINK:PROFile:PMCH:SUBFrame8:MODulation:TYPE?	851
[::SENSe]:EVM:DLINK:PROFile:PMCH:SUBFrame8:PWRBoost <rel_ampl>	846
[::SENSe]:EVM:DLINK:PROFile:PMCH:SUBFrame8:PWRBoost?	846
[::SENSe]:EVM:DLINK:PROFile:PMCH:SUBFrame9:ACTive OFF ON 0 1	842
[::SENSe]:EVM:DLINK:PROFile:PMCH:SUBFrame9:ACTive?	842
[::SENSe]:EVM:DLINK:PROFile:PMCH:SUBFrame9:MODulation:TYPE QPSK QAM16 QAM64	852
[::SENSe]:EVM:DLINK:PROFile:PMCH:SUBFrame9:MODulation:TYPE?	852
[::SENSe]:EVM:DLINK:PROFile:PMCH:SUBFrame9:PWRBoost <rel_ampl>	847
[::SENSe]:EVM:DLINK:PROFile:PMCH:SUBFrame9:PWRBoost?	847
[::SENSe]:EVM:DLINK:PROFile:PRS INCLude EXCLude	799
[::SENSe]:EVM:DLINK:PROFile:PRS?	799
[::SENSe]:EVM:DLINK:PROFile:PRS:ACTive OFF ON 0 1	826
[::SENSe]:EVM:DLINK:PROFile:PRS:ACTive?	826
[::SENSe]:EVM:DLINK:PROFile:PRS:BANDwidth B1M4 B3M B5M B10M B15M B20M	827
[::SENSe]:EVM:DLINK:PROFile:PRS:BANDwidth?	827

List of Commands

[:SENSe]:EVM:DLINK:PROFile:PRS:INDEX <integer>	828
[:SENSe]:EVM:DLINK:PROFile:PRS:INDEX?	828
[:SENSe]:EVM:DLINK:PROFile:PRS:PWRBoost <rel_ampl>	828
[:SENSe]:EVM:DLINK:PROFile:PRS:PWRBoost?	828
[:SENSe]:EVM:DLINK:PROFile:PRS:SUBFrame:NUMBER N1 N2 N4 N6	829
[:SENSe]:EVM:DLINK:PROFile:PRS:SUBFrame:NUMBER?	829
[:SENSe]:EVM:DLINK:PROFile:PSS INCLUDE EXCLUDE	795
[:SENSe]:EVM:DLINK:PROFile:PSS?	795
[:SENSe]:EVM:DLINK:PROFile:PSS:PWRBoost <rel_ampl>	806
[:SENSe]:EVM:DLINK:PROFile:PSS:PWRBoost?	806
[:SENSe]:EVM:DLINK:PROFile:QAM16 INCLUDE EXCLUDE	804
[:SENSe]:EVM:DLINK:PROFile:QAM16?	804
[:SENSe]:EVM:DLINK:PROFile:QAM16:RNTI <integer>	861
[:SENSe]:EVM:DLINK:PROFile:QAM16:RNTI?	861
[:SENSe]:EVM:DLINK:PROFile:QAM16:UERS INCLUDE EXCLUDE	866
[:SENSe]:EVM:DLINK:PROFile:QAM16:UERS?	866
[:SENSe]:EVM:DLINK:PROFile:QAM16:UERS:ACTIVE OFF ON 0 1	863
[:SENSe]:EVM:DLINK:PROFile:QAM16:UERS:ACTIVE?	863
[:SENSe]:EVM:DLINK:PROFile:QAM16:UERS:PORT P5 P7 P8	871
[:SENSe]:EVM:DLINK:PROFile:QAM16:UERS:PORT?	871
[:SENSe]:EVM:DLINK:PROFile:QAM16:UERS:PWRBoost <rel_ampl>	868
[:SENSe]:EVM:DLINK:PROFile:QAM16:UERS:PWRBoost?	868
[:SENSe]:EVM:DLINK:PROFile:QAM16:UERS:SCID <integer>	873
[:SENSe]:EVM:DLINK:PROFile:QAM16:UERS:SCID?	873
[:SENSe]:EVM:DLINK:PROFile:QAM64 INCLUDE EXCLUDE	804
[:SENSe]:EVM:DLINK:PROFile:QAM64?	804
[:SENSe]:EVM:DLINK:PROFile:QAM64:RNTI <integer>	861
[:SENSe]:EVM:DLINK:PROFile:QAM64:RNTI?	861
[:SENSe]:EVM:DLINK:PROFile:QAM64:UERS INCLUDE EXCLUDE	866
[:SENSe]:EVM:DLINK:PROFile:QAM64:UERS?	866
[:SENSe]:EVM:DLINK:PROFile:QAM64:UERS:ACTIVE OFF ON 0 1	864

List of Commands

[[:SENSe]:EVM:DLINK:PROFile:QAM64:UERS:ACTive?	864
[[:SENSe]:EVM:DLINK:PROFile:QAM64:UERS:PORT P5 P7 P8	871
[[:SENSe]:EVM:DLINK:PROFile:QAM64:UERS:PORT?	871
[[:SENSe]:EVM:DLINK:PROFile:QAM64:UERS:PWRBoost <rel_amp]>	869
[[:SENSe]:EVM:DLINK:PROFile:QAM64:UERS:PWRBoost?	869
[[:SENSe]:EVM:DLINK:PROFile:QAM64:UERS:SCID <integer>	874
[[:SENSe]:EVM:DLINK:PROFile:QAM64:UERS:SCID?	874
[[:SENSe]:EVM:DLINK:PROFile:QPSK INCLude EXCLude	803
[[:SENSe]:EVM:DLINK:PROFile:QPSK?	803
[[:SENSe]:EVM:DLINK:PROFile:QPSK:RNTI <integer>	860
[[:SENSe]:EVM:DLINK:PROFile:QPSK:RNTI?	860
[[:SENSe]:EVM:DLINK:PROFile:QPSK:UERS INCLude EXCLude	865
[[:SENSe]:EVM:DLINK:PROFile:QPSK:UERS?	865
[[:SENSe]:EVM:DLINK:PROFile:QPSK:UERS:ACTive OFF ON 0 1	863
[[:SENSe]:EVM:DLINK:PROFile:QPSK:UERS:ACTive?	863
[[:SENSe]:EVM:DLINK:PROFile:QPSK:UERS:PORT P5 P7 P8	870
[[:SENSe]:EVM:DLINK:PROFile:QPSK:UERS:PORT?	870
[[:SENSe]:EVM:DLINK:PROFile:QPSK:UERS:PWRBoost <rel_amp]>	868
[[:SENSe]:EVM:DLINK:PROFile:QPSK:UERS:PWRBoost?	868
[[:SENSe]:EVM:DLINK:PROFile:QPSK:UERS:SCID <integer>	872
[[:SENSe]:EVM:DLINK:PROFile:QPSK:UERS:SCID?	872
[[:SENSe]:EVM:DLINK:PROFile:RS INCLude EXCLude	798
[[:SENSe]:EVM:DLINK:PROFile:RS?	798
[[:SENSe]:EVM:DLINK:PROFile:RS:PWRBoost <rel_amp]>	808
[[:SENSe]:EVM:DLINK:PROFile:RS:PWRBoost?	808
[[:SENSe]:EVM:DLINK:PROFile:SSS INCLude EXCLude	796
[[:SENSe]:EVM:DLINK:PROFile:SSS?	796
[[:SENSe]:EVM:DLINK:PROFile:SSS:PWRBoost <rel_amp]>	807
[[:SENSe]:EVM:DLINK:PROFile:SSS:PWRBoost?	807
[[:SENSe]:EVM:DLINK:PROFile:UPDate	918
[[:SENSe]:EVM:DLINK:PROFile:USER<n>:DECoded:PDsch INCLude EXCLude	803

List of Commands

[:SENSe]:EVM:DLINK:PROFile:USER<n>:DECoded:PDSCh?	803
[:SENSe]:EVM:DLINK:PROFile:USER<n>:DECoded:PDSCh:CWONe:ENABle ON OFF 0 1	904
[:SENSe]:EVM:DLINK:PROFile:USER<n>:DECoded:PDSCh:CWONe:ENABle?	904
[:SENSe]:EVM:DLINK:PROFile:USER<n>:DECoded:PDSCh:CWONe:PWRBoost <rel_ampl>	896
[:SENSe]:EVM:DLINK:PROFile:USER<n>:DECoded:PDSCh:CWONe:PWRBoost?	896
[:SENSe]:EVM:DLINK:PROFile:USER<n>:DECoded:PDSCh:CWZero:ENABle ON OFF 0 1	904
[:SENSe]:EVM:DLINK:PROFile:USER<n>:DECoded:PDSCh:CWZero:ENABle?	904
[:SENSe]:EVM:DLINK:PROFile:USER<n>:DECoded:PDSCh:CWZero:PWRBoost <rel_ampl>	896
[:SENSe]:EVM:DLINK:PROFile:USER<n>:DECoded:PDSCh:CWZero:PWRBoost?	896
[:SENSe]:EVM:DLINK:PROFile:USER<n>:DECoded:PDSCh:EPRE <rel_ampl>	895
[:SENSe]:EVM:DLINK:PROFile:USER<n>:DECoded:PDSCh:EPRE?	895
[:SENSe]:EVM:DLINK:PROFile:USER<n>:DELete	907
[:SENSe]:EVM:DLINK:PROFile:USER<n>:PDSCh INCLude EXCLude	802
[:SENSe]:EVM:DLINK:PROFile:USER<n>:PDSCh?	802
[:SENSe]:EVM:DLINK:PROFile:USER<n>:PDSCh:ADD:ALLocation	858
[:SENSe]:EVM:DLINK:PROFile:USER<n>:PDSCh:COUNt?	919
[:SENSe]:EVM:DLINK:PROFile:USER<n>:PDSCh:CWONe:MODulation:TYPE QPSK QAM16 QAM64	884
[:SENSe]:EVM:DLINK:PROFile:USER<n>:PDSCh:CWONe:MODulation:TYPE?	884
[:SENSe]:EVM:DLINK:PROFile:USER<n>:PDSCh:CWONe:MODulation:TYPE:COUple OFF ON 0 1	886
[:SENSe]:EVM:DLINK:PROFile:USER<n>:PDSCh:CWONe:MODulation:TYPE:COUple?	886
[:SENSe]:EVM:DLINK:PROFile:USER<n>:PDSCh:CWONe:PWRBoost <rel_ampl>	892
[:SENSe]:EVM:DLINK:PROFile:USER<n>:PDSCh:CWONe:PWRBoost?	892
[:SENSe]:EVM:DLINK:PROFile:USER<n>:PDSCh:CWONe:PWRBoost:COUple OFF ON 0 1	899
[:SENSe]:EVM:DLINK:PROFile:USER<n>:PDSCh:CWONe:PWRBoost:COUple?	899
[:SENSe]:EVM:DLINK:PROFile:USER<n>:PDSCh:EPRE <rel_ampl>	887
[:SENSe]:EVM:DLINK:PROFile:USER<n>:PDSCh:EPRE?	887
[:SENSe]:EVM:DLINK:PROFile:USER<n>:PDSCh:EPRE:COUple OFF ON 0 1	898
[:SENSe]:EVM:DLINK:PROFile:USER<n>:PDSCh:EPRE:COUple?	898
[:SENSe]:EVM:DLINK:PROFile:USER<n>:PDSCh:FINDex F0 F1	905
[:SENSe]:EVM:DLINK:PROFile:USER<n>:PDSCh:FINDex?	905
[:SENSe]:EVM:DLINK:PROFile:USER<n>:PDSCh:FINDex:COUple OFF ON 0 1	906

List of Commands

[[:SENSe]:EVM:DLINK:PROFile:USER<n>:PDSCh:FINDeX:COUPle?	906
[[:SENSe]:EVM:DLINK:PROFile:USER<n>:PDSCh:MODulation:TYPE QPSK QAM16 QAM64	884
[[:SENSe]:EVM:DLINK:PROFile:USER<n>:PDSCh:MODulation:TYPE?	884
[[:SENSe]:EVM:DLINK:PROFile:USER<n>:PDSCh:MODulation:TYPE:COUPle OFF ON 0 1	886
[[:SENSe]:EVM:DLINK:PROFile:USER<n>:PDSCh:MODulation:TYPE:COUPle?	886
[[:SENSe]:EVM:DLINK:PROFile:USER<n>:PDSCh:PWRBoost <rel_ampl>	890
[[:SENSe]:EVM:DLINK:PROFile:USER<n>:PDSCh:PWRBoost?	890
[[:SENSe]:EVM:DLINK:PROFile:USER<n>:PDSCh:PWRBoost:COUPle OFF ON 0 1	897
[[:SENSe]:EVM:DLINK:PROFile:USER<n>:PDSCh:PWRBoost:COUPle?	897
[[:SENSe]:EVM:DLINK:PROFile:USER<n>:PDSCh:RBALloc<m>:CWONe:MODulation:TYPE QPSK QAM16 QAM64	880
[[:SENSe]:EVM:DLINK:PROFile:USER<n>:PDSCh:RBALloc<m>:CWONe:MODulation:TYPE?	880
[[:SENSe]:EVM:DLINK:PROFile:USER<n>:PDSCh:RBALloc<m>:CWONe:PWRBoost <rel_ampl>	882
[[:SENSe]:EVM:DLINK:PROFile:USER<n>:PDSCh:RBALloc<m>:CWONe:PWRBoost?	882
[[:SENSe]:EVM:DLINK:PROFile:USER<n>:PDSCh:RBALloc<m>:DElete	858
[[:SENSe]:EVM:DLINK:PROFile:USER<n>:PDSCh:RBALloc<m>:EPRE <rel_ampl>	878
[[:SENSe]:EVM:DLINK:PROFile:USER<n>:PDSCh:RBALloc<m>:EPRE?	878
[[:SENSe]:EVM:DLINK:PROFile:USER<n>:PDSCh:RBALloc<m>:FINDeX F0 F1	883
[[:SENSe]:EVM:DLINK:PROFile:USER<n>:PDSCh:RBALloc<m>:FINDeX?	883
[[:SENSe]:EVM:DLINK:PROFile:USER<n>:PDSCh:RBALloc<m>:MODulation:TYPE QPSK QAM16 QAM64 . 879	
[[:SENSe]:EVM:DLINK:PROFile:USER<n>:PDSCh:RBALloc<m>:MODulation:TYPE?	879
[[:SENSe]:EVM:DLINK:PROFile:USER<n>:PDSCh:RBALloc<m>:PWRBoost <rel_ampl>	881
[[:SENSe]:EVM:DLINK:PROFile:USER<n>:PDSCh:RBALloc<m>:PWRBoost?	881
[[:SENSe]:EVM:DLINK:PROFile:USER<n>:PDSCh:RBALloc<m>:RB:END <integer>	875
[[:SENSe]:EVM:DLINK:PROFile:USER<n>:PDSCh:RBALloc<m>:RB:END?	875
[[:SENSe]:EVM:DLINK:PROFile:USER<n>:PDSCh:RBALloc<m>:RB:STARt <integer>	874
[[:SENSe]:EVM:DLINK:PROFile:USER<n>:PDSCh:RBALloc<m>:RB:STARt?	874
[[:SENSe]:EVM:DLINK:PROFile:USER<n>:PDSCh:RBALloc<m>:SLOT:END <integer>	877
[[:SENSe]:EVM:DLINK:PROFile:USER<n>:PDSCh:RBALloc<m>:SLOT:END?	877
[[:SENSe]:EVM:DLINK:PROFile:USER<n>:PDSCh:RBALloc<m>:SLOT:STARt <integer>	876
[[:SENSe]:EVM:DLINK:PROFile:USER<n>:PDSCh:RBALloc<m>:SLOT:STARt?	876

List of Commands

[:SENSe]:EVM:DLINK:PROFile:USER<n>:RNTI <integer>	860
[:SENSe]:EVM:DLINK:PROFile:USER<n>:RNTI?	860
[:SENSe]:EVM:DLINK:PROFile:USER<n>:UERS INCLude EXCLude	864
[:SENSe]:EVM:DLINK:PROFile:USER<n>:UERS?	864
[:SENSe]:EVM:DLINK:PROFile:USER<n>:UERS:ACTive OFF ON 0 1	862
[:SENSe]:EVM:DLINK:PROFile:USER<n>:UERS:ACTive?	862
[:SENSe]:EVM:DLINK:PROFile:USER<n>:UERS:PORT P5 P7 P8	869
[:SENSe]:EVM:DLINK:PROFile:USER<n>:UERS:PORT?	869
[:SENSe]:EVM:DLINK:PROFile:USER<n>:UERS:PWRBoost <rel_ampl>	867
[:SENSe]:EVM:DLINK:PROFile:USER<n>:UERS:PWRBoost?	867
[:SENSe]:EVM:DLINK:PROFile:USER<n>:UERS:SCID <integer>	872
[:SENSe]:EVM:DLINK:PROFile:USER<n>:UERS:SCID?	872
[:SENSe]:EVM:DLINK:PROFile:USER1 50:PDSCh:CBINdex <integer>	913
[:SENSe]:EVM:DLINK:PROFile:USER1 50:PDSCh:CBINdex?	913
[:SENSe]:EVM:DLINK:PROFile:USER1 50:PDSCh:CDD WOCDD LDCDD	912
[:SENSe]:EVM:DLINK:PROFile:USER1 50:PDSCh:CDD?	912
[:SENSe]:EVM:DLINK:PROFile:USER1 50:PDSCh:CWONe:ENABle ON OFF 0 1	902
[:SENSe]:EVM:DLINK:PROFile:USER1 50:PDSCh:CWONe:ENABle?	902
[:SENSe]:EVM:DLINK:PROFile:USER1 50:PDSCh:CWZero:ENABle ON OFF 0 1	899
[:SENSe]:EVM:DLINK:PROFile:USER1 50:PDSCh:CWZero:ENABle?	899
[:SENSe]:EVM:DLINK:PROFile:USER1 50:PDSCh:NCODewords <integer>	911
[:SENSe]:EVM:DLINK:PROFile:USER1 50:PDSCh:NCODewords?	911
[:SENSe]:EVM:DLINK:PROFile:USER1 50:PDSCh:NLAYers <integer>	909
[:SENSe]:EVM:DLINK:PROFile:USER1 50:PDSCh:NLAYers?	909
[:SENSe]:EVM:DLINK:PROFile:USER1 50:PDSCh:PRECoding OFF TXDiversity SMULtiplex	908
[:SENSe]:EVM:DLINK:PROFile:USER1 50:PDSCh:PRECoding?	908
[:SENSe]:EVM:DLINK:SYNC:ANTenna:DETECT:THReshold <rel_ampl>	775
[:SENSe]:EVM:DLINK:SYNC:ANTenna:DETECT:THReshold?	775
[:SENSe]:EVM:DLINK:SYNC:ANTenna:INACTIVE:PATHs INCLude EXCLude	777
[:SENSe]:EVM:DLINK:SYNC:ANTenna:INACTIVE:PATHs?	777
[:SENSe]:EVM:DLINK:SYNC:ANTenna:NUMBer ANT1 ANT2 ANT4	770

List of Commands

[:SENSe]:EVM:DLINK:SYNC:ANTenna:NUMBer?	770
[:SENSe]:EVM:DLINK:SYNC:ANTenna:PORT P0 P1 P2 P3	773
[:SENSe]:EVM:DLINK:SYNC:ANTenna:PORT?	773
[:SENSe]:EVM:DLINK:SYNC:ANTenna:PORT:AUTO OFF ON 0 1	773
[:SENSe]:EVM:DLINK:SYNC:ANTenna:PORT:AUTO?	773
[:SENSe]:EVM:DLINK:SYNC:CID <integer>	769
[:SENSe]:EVM:DLINK:SYNC:CID?	769
[:SENSe]:EVM:DLINK:SYNC:CID:AUTO OFF ON 0 1	769
[:SENSe]:EVM:DLINK:SYNC:CID:AUTO?	769
[:SENSe]:EVM:DLINK:SYNC:CPLength AUTO NORMAl EXTended	1103
[:SENSe]:EVM:DLINK:SYNC:CPLength?	1103
[:SENSe]:EVM:DLINK:SYNC:CPLength:AUTO OFF ON 0 1	1103
[:SENSe]:EVM:DLINK:SYNC:CPLength:AUTO?	1103
[:SENSe]:EVM:DLINK:SYNC:MIMO:DECoding NONE GPPMimo	779
[:SENSe]:EVM:DLINK:SYNC:MIMO:DECoding?	779
[:SENSe]:EVM:DLINK:SYNC:RSPRs GPP CUSTom	768
[:SENSe]:EVM:DLINK:SYNC:RSPRs?	768
[:SENSe]:EVM:DLINK:SYNC:SS:ANTenna:PORT P0 P1 P2 P3 APORts	776
[:SENSe]:EVM:DLINK:SYNC:SS:ANTenna:PORT?	776
[:SENSe]:EVM:DLINK:SYNC:TYPE PSS RS	766
[:SENSe]:EVM:DLINK:SYNC:TYPE?	766
[:SENSe]:EVM:EETTime OFF ON 0 1	1125
[:SENSe]:EVM:EETTime?	1125
[:SENSe]:EVM:EQUalizer:TRaining OFF RS RSD	1108
[:SENSe]:EVM:EQUalizer:TRaining?	1108
[:SENSe]:EVM:EQUalizer:TRaining:MAFilter OFF ON 0 1	1109
[:SENSe]:EVM:EQUalizer:TRaining:MAFilter?	1109
[:SENSe]:EVM:EQUalizer:TRaining:MAFilter:LENGth <integer>	1109
[:SENSe]:EVM:EQUalizer:TRaining:MAFilter:LENGth?	1109
[:SENSe]:EVM:EQUalizer:TRaining:MCFNormalize OFF ON 0 1	1110
[:SENSe]:EVM:EQUalizer:TRaining:MCFNormalize?	1110

List of Commands

[:SENSe]:EVM:EQUalizer:TRAIning:MODE ZFORcing LSQuares	1111
[:SENSe]:EVM:EQUalizer:TRAIning:MODE?	1111
[:SENSe]:EVM:EVMMinimize OFF GPP TRACking	1121
[:SENSe]:EVM:EVMMinimize?	1121
[:SENSe]:EVM:EVMMinimize:AMPLitude OFF ON 0 1	1123
[:SENSe]:EVM:EVMMinimize:AMPLitude?	1123
[:SENSe]:EVM:EVMMinimize:FREQuency OFF ON 0 1	1123
[:SENSe]:EVM:EVMMinimize:FREQuency?	1123
[:SENSe]:EVM:EVMMinimize:IQIMbalance OFF ON 0 1	1124
[:SENSe]:EVM:EVMMinimize:IQIMbalance?	1124
[:SENSe]:EVM:EVMMinimize:IQOffset OFF ON 0 1	1124
[:SENSe]:EVM:EVMMinimize:IQOffset?	1124
[:SENSe]:EVM:EVMMinimize:TIMing OFF ON 0 1	1122
[:SENSe]:EVM:EVMMinimize:TIMing?	1122
[:SENSe]:EVM:EXTended:FREQuency:LOCK:RANGe OFF ON 0 1	1106
[:SENSe]:EVM:EXTended:FREQuency:LOCK:RANGe?	1106
[:SENSe]:EVM:FREQuency:SYNThesis[:STATe] 1 2	1120
[:SENSe]:EVM:FREQuency:SYNThesis[:STATe]?	1120
[:SENSe]:EVM:MCFilter:STATe OFF ON 0 1	1119
[:SENSe]:EVM:MCFilter:STATe?	1119
[:SENSe]:EVM:ODACTive OFF ON 0 1	1125
[:SENSe]:EVM:ODACTive?	1125
[:SENSe]:EVM:POWEr:BOOSt:NORMAlize OFF ON 0 1	1118
[:SENSe]:EVM:POWEr:BOOSt:NORMAlize?	1118
[:SENSe]:EVM:PROFile:AUTO[:DETECT] OFF ON 0 1	790
[:SENSe]:EVM:PROFile:AUTO[:DETECT]?	790
[:SENSe]:EVM:PROFile:COPI[:IMMEdiate]	920
[:SENSe]:EVM:PROFile:MFAlysis OFF ON 0 1	856
[:SENSe]:EVM:PROFile:MFAlysis?	856
[:SENSe]:EVM:PROFile:NALLocation INCLude EXCLude	801
[:SENSe]:EVM:PROFile:NALLocation?	801

List of Commands

[[:SENSe]:EVM:PROFile:SMAPping[:SElect] F0 F1	857
[[:SENSe]:EVM:PROFile:SMAPping[:SElect]?	857
[[:SENSe]:EVM:REPort:DB OFF ON 0 1	1117
[[:SENSe]:EVM:REPort:DB?	1117
[[:SENSe]:EVM:REPort:POWer:RELative OFF ON 0 1	1118
[[:SENSe]:EVM:REPort:POWer:RELative?	1118
[[:SENSe]:EVM:SYMBol:TIMing:ADJust MAX MIN STARt END CENTer FFTSize	1111
[[:SENSe]:EVM:SYMBol:TIMing:ADJust?	1111
[[:SENSe]:EVM:SYMBol:TIMing:ADJust:USER <percent>	1113
[[:SENSe]:EVM:SYMBol:TIMing:ADJust:USER?	1113
[[:SENSe]:EVM:TIME:ASBoundary FRAME HALF SUB SLOT	788
[[:SENSe]:EVM:TIME:ASBoundary?	788
[[:SENSe]:EVM:TIME:INTerval:SLOT <integer>	786
[[:SENSe]:EVM:TIME:INTerval:SLOT?	786
[[:SENSe]:EVM:TIME:INTerval:SYMBol <integer>	787
[[:SENSe]:EVM:TIME:INTerval:SYMBol?	787
[[:SENSe]:EVM:TIME:OFFSet:SLOT <integer>	785
[[:SENSe]:EVM:TIME:OFFSet:SLOT?	785
[[:SENSe]:EVM:TIME:OFFSet:SYMBol <integer>	786
[[:SENSe]:EVM:TIME:OFFSet:SYMBol?	786
[[:SENSe]:EVM:TIME:RESult:LENGth <integer>	785
[[:SENSe]:EVM:TIME:RESult:LENGth?	785
[[:SENSe]:EVM:TIME:SCALe:FACTor <value>	1119
[[:SENSe]:EVM:TIME:SCALe:FACTor?	1119
[[:SENSe]:EVM:ULINK:DECode:ANFMode MULTiplexing BUNDling	1102
[[:SENSe]:EVM:ULINK:DECode:ANFMode?	1102
[[:SENSe]:EVM:ULINK:DECode:PUCCh NONE DESCrambled DECCoded	1086
[[:SENSe]:EVM:ULINK:DECode:PUCCh?	1086
[[:SENSe]:EVM:ULINK:DECode:PUCCh:CQI:ISIZe <integer>	1101
[[:SENSe]:EVM:ULINK:DECode:PUCCh:CQI:ISIZe?	1101
[[:SENSe]:EVM:ULINK:DECode:PUCCh:CQI:ISIZe:AUTO OFF ON 0 1	1101

List of Commands

[:SENSe]:EVM:ULINK:DECode:PUCCh:CQI:ISIZe:AUTO?	1101
[:SENSe]:EVM:ULINK:DECode:PUCCh:HARQ:ISIZe <integer>	1100
[:SENSe]:EVM:ULINK:DECode:PUCCh:HARQ:ISIZe?	1100
[:SENSe]:EVM:ULINK:DECode:PUCCh:HARQ:ISIZe:AUTO OFF ON 0 1	1100
[:SENSe]:EVM:ULINK:DECode:PUCCh:HARQ:ISIZe:AUTO?	1100
[:SENSe]:EVM:ULINK:DECode:PUSCh NONE DESCrambled DRMatched DCBLock DTBBlock	1086
[:SENSe]:EVM:ULINK:DECode:PUSCh?	1086
[:SENSe]:EVM:ULINK:DECode:PUSCh:CQI:ISIZe <integer>	1098
[:SENSe]:EVM:ULINK:DECode:PUSCh:CQI:ISIZe?	1098
[:SENSe]:EVM:ULINK:DECode:PUSCh:CQI:ISIZe:AUTO OFF ON 0 1	1098
[:SENSe]:EVM:ULINK:DECode:PUSCh:CQI:ISIZe:AUTO?	1098
[:SENSe]:EVM:ULINK:DECode:PUSCh:CQI:OFFSet <integer>	1099
[:SENSe]:EVM:ULINK:DECode:PUSCh:CQI:OFFSet?	1099
[:SENSe]:EVM:ULINK:DECode:PUSCh:HARQ:ISIZe <integer>	1095
[:SENSe]:EVM:ULINK:DECode:PUSCh:HARQ:ISIZe?	1095
[:SENSe]:EVM:ULINK:DECode:PUSCh:HARQ:ISIZe:AUTO OFF ON 0 1	1095
[:SENSe]:EVM:ULINK:DECode:PUSCh:HARQ:ISIZe:AUTO?	1095
[:SENSe]:EVM:ULINK:DECode:PUSCh:HARQ:OFFSet <integer>	1096
[:SENSe]:EVM:ULINK:DECode:PUSCh:HARQ:OFFSet?	1096
[:SENSe]:EVM:ULINK:DECode:PUSCh:RI:ISIZe <integer>	1097
[:SENSe]:EVM:ULINK:DECode:PUSCh:RI:ISIZe?	1097
[:SENSe]:EVM:ULINK:DECode:PUSCh:RI:ISIZe:AUTO OFF ON 0 1	1097
[:SENSe]:EVM:ULINK:DECode:PUSCh:RI:ISIZe:AUTO?	1097
[:SENSe]:EVM:ULINK:DECode:PUSCh:RI:OFFSet <integer>	1097
[:SENSe]:EVM:ULINK:DECode:PUSCh:RI:OFFSet?	1097
[:SENSe]:EVM:ULINK:FLATness:CHANnel:CONDition NORMAl EXTReme	1128
[:SENSe]:EVM:ULINK:FLATness:CHANnel:CONDition?	1128
[:SENSe]:EVM:ULINK:FREQuency:CENTer <freq>	1128
[:SENSe]:EVM:ULINK:FREQuency:CENTer?	1128
[:SENSe]:EVM:ULINK:FREQuency:HIGH <freq>	1129
[:SENSe]:EVM:ULINK:FREQuency:HIGH?	1129

List of Commands

[:SENSe]:EVM:ULINK:FREQuency:LOW <freq>	1129
[:SENSe]:EVM:ULINK:FREQuency:LOW?	1129
[:SENSe]:EVM:ULINK:PROFile:ADD:USER	937
[:SENSe]:EVM:ULINK:PROFile:AUTO:CID <integer>	939
[:SENSe]:EVM:ULINK:PROFile:AUTO:CID?	939
[:SENSe]:EVM:ULINK:PROFile:AUTO[:DETEct]:POWer OFF ON 0 1	921
[:SENSe]:EVM:ULINK:PROFile:AUTO[:DETEct]:POWer?	921
[:SENSe]:EVM:ULINK:PROFile:AUTO:HOPPing:GROup OFF ON 0 1	942
[:SENSe]:EVM:ULINK:PROFile:AUTO:HOPPing:GROup?	942
[:SENSe]:EVM:ULINK:PROFile:AUTO:HOPPing:SEQuence OFF ON 0 1	943
[:SENSe]:EVM:ULINK:PROFile:AUTO:HOPPing:SEQuence?	943
[:SENSe]:EVM:ULINK:PROFile:AUTO:PRACH INCLude EXCLude	930
[:SENSe]:EVM:ULINK:PROFile:AUTO:PRACH?	930
[:SENSe]:EVM:ULINK:PROFile:AUTO:PRACH:ACTive OFF ON 0 1	1041
[:SENSe]:EVM:ULINK:PROFile:AUTO:PRACH:ACTive?	1041
[:SENSe]:EVM:ULINK:PROFile:AUTO:PRACH:CINdex <integer>	1044
[:SENSe]:EVM:ULINK:PROFile:AUTO:PRACH:CINdex?	1044
[:SENSe]:EVM:ULINK:PROFile:AUTO:PRACH:CSSet UNREstricted RESTRicted	1047
[:SENSe]:EVM:ULINK:PROFile:AUTO:PRACH:CSSet?	1047
[:SENSe]:EVM:ULINK:PROFile:AUTO:PRACH:LRSin dex <integer>	1046
[:SENSe]:EVM:ULINK:PROFile:AUTO:PRACH:LRSin dex?	1046
[:SENSe]:EVM:ULINK:PROFile:AUTO:PRACH:NCSConfig <integer>	1048
[:SENSe]:EVM:ULINK:PROFile:AUTO:PRACH:NCSConfig?	1048
[:SENSe]:EVM:ULINK:PROFile:AUTO:PRACH:NRAPrb <integer>	1043
[:SENSe]:EVM:ULINK:PROFile:AUTO:PRACH:NRAPrb?	1043
[:SENSe]:EVM:ULINK:PROFile:AUTO:PRACH:PINdex <integer>	1050
[:SENSe]:EVM:ULINK:PROFile:AUTO:PRACH:PINdex?	1050
[:SENSe]:EVM:ULINK:PROFile:AUTO:PRACH:PWRBoost <rel_amp>	1051
[:SENSe]:EVM:ULINK:PROFile:AUTO:PRACH:PWRBoost?	1051
[:SENSe]:EVM:ULINK:PROFile:AUTO:PRACH:SRESorce <integer>	1053
[:SENSe]:EVM:ULINK:PROFile:AUTO:PRACH:SRESorce?	1053

List of Commands

[:SENSe]:EVM:ULINK:PROFile:AUTO:PUCCh INCLude EXCLude	927
[:SENSe]:EVM:ULINK:PROFile:AUTO:PUCCh?	927
[:SENSe]:EVM:ULINK:PROFile:AUTO:PUCCh:ACTive OFF ON 0 1	995
[:SENSe]:EVM:ULINK:PROFile:AUTO:PUCCh:ACTive?	995
[:SENSe]:EVM:ULINK:PROFile:AUTO:PUCCh:CSHift <integer>	1014
[:SENSe]:EVM:ULINK:PROFile:AUTO:PUCCh:CSHift?	1014
[:SENSe]:EVM:ULINK:PROFile:AUTO:PUCCh:DMRS INCLude EXCLude	928
[:SENSe]:EVM:ULINK:PROFile:AUTO:PUCCh:DMRS?	928
[:SENSe]:EVM:ULINK:PROFile:AUTO:PUCCh:DMRS:GROup <integer>	1021
[:SENSe]:EVM:ULINK:PROFile:AUTO:PUCCh:DMRS:GROup?	1021
[:SENSe]:EVM:ULINK:PROFile:AUTO:PUCCh:DMRS:PARams OFF ON 0 1	996
[:SENSe]:EVM:ULINK:PROFile:AUTO:PUCCh:DMRS:PARams?	996
[:SENSe]:EVM:ULINK:PROFile:AUTO:PUCCh:DMRS:PWRBoost <rel_amp >	1024
[:SENSe]:EVM:ULINK:PROFile:AUTO:PUCCh:DMRS:PWRBoost?	1024
[:SENSe]:EVM:ULINK:PROFile:AUTO:PUCCh:FNpucch:AUTO OFF ON 0 1	1005
[:SENSe]:EVM:ULINK:PROFile:AUTO:PUCCh:FNpucch:AUTO?	1005
[:SENSe]:EVM:ULINK:PROFile:AUTO:PUCCh:FORMat T1 T1A T1B T2 T2A T2B T1S T1AS T1BS	1009
[:SENSe]:EVM:ULINK:PROFile:AUTO:PUCCh:FORMat?	1009
[:SENSe]:EVM:ULINK:PROFile:AUTO:PUCCh:NCS:ONE <integer>	999
[:SENSe]:EVM:ULINK:PROFile:AUTO:PUCCh:NCS:ONE?	999
[:SENSe]:EVM:ULINK:PROFile:AUTO:PUCCh:N:ONE <integer>	1026
[:SENSe]:EVM:ULINK:PROFile:AUTO:PUCCh:N:ONE?	1026
[:SENSe]:EVM:ULINK:PROFile:AUTO:PUCCh:NRB:TWO <integer>	998
[:SENSe]:EVM:ULINK:PROFile:AUTO:PUCCh:NRB:TWO?	998
[:SENSe]:EVM:ULINK:PROFile:AUTO:PUCCh:N:TWO <integer>	1001
[:SENSe]:EVM:ULINK:PROFile:AUTO:PUCCh:N:TWO?	1001
[:SENSe]:EVM:ULINK:PROFile:AUTO:PUCCh:OS INDeX0 INDeX1 INDeX2	1016
[:SENSe]:EVM:ULINK:PROFile:AUTO:PUCCh:OS?	1016
[:SENSe]:EVM:ULINK:PROFile:AUTO:PUCCh:PWRBoost <rel_amp >	1019
[:SENSe]:EVM:ULINK:PROFile:AUTO:PUCCh:PWRBoost?	1019
[:SENSe]:EVM:ULINK:PROFile:AUTO:PUCCh:RB <integer>	1007

List of Commands

[:SENSe]:EVM:ULINK:PROFile:AUTO:PUCCh:RB?	1007
[:SENSe]:EVM:ULINK:PROFile:AUTO:PUCCh:SHIFt <integer>	1002
[:SENSe]:EVM:ULINK:PROFile:AUTO:PUCCh:SHIFt?	1002
[:SENSe]:EVM:ULINK:PROFile:AUTO:PUCCh:SSLot <integer>	1004
[:SENSe]:EVM:ULINK:PROFile:AUTO:PUCCh:SSLot?	1004
[:SENSe]:EVM:ULINK:PROFile:AUTO:PUCCh:SSLot:AUTO OFF ON 0 1	1004
[:SENSe]:EVM:ULINK:PROFile:AUTO:PUCCh:SSLot:AUTO?	1004
[:SENSe]:EVM:ULINK:PROFile:AUTO:PUSCh INCLude EXCLude	925
[:SENSe]:EVM:ULINK:PROFile:AUTO:PUSCh?	925
[:SENSe]:EVM:ULINK:PROFile:AUTO:PUSCh:ACTive OFF ON 0 1	945
[:SENSe]:EVM:ULINK:PROFile:AUTO:PUSCh:ACTive?	945
[:SENSe]:EVM:ULINK:PROFile:AUTO:PUSCh:DMRS INCLude EXCLude	926
[:SENSe]:EVM:ULINK:PROFile:AUTO:PUSCh:DMRS?	926
[:SENSe]:EVM:ULINK:PROFile:AUTO:PUSCh:DMRS:CSHift <integer>	976
[:SENSe]:EVM:ULINK:PROFile:AUTO:PUSCh:DMRS:CSHift?	976
[:SENSe]:EVM:ULINK:PROFile:AUTO:PUSCh:DMRS:GROup <integer>	972
[:SENSe]:EVM:ULINK:PROFile:AUTO:PUSCh:DMRS:GROup?	972
[:SENSe]:EVM:ULINK:PROFile:AUTO:PUSCh:DMRS:ONE <integer>	948
[:SENSe]:EVM:ULINK:PROFile:AUTO:PUSCh:DMRS:ONE?	948
[:SENSe]:EVM:ULINK:PROFile:AUTO:PUSCh:DMRS:PARams OFF ON 0 1	947
[:SENSe]:EVM:ULINK:PROFile:AUTO:PUSCh:DMRS:PARams?	947
[:SENSe]:EVM:ULINK:PROFile:AUTO:PUSCh:DMRS:PWRBoost <rel_amp>	979
[:SENSe]:EVM:ULINK:PROFile:AUTO:PUSCh:DMRS:PWRBoost?	979
[:SENSe]:EVM:ULINK:PROFile:AUTO:PUSCh:DMRS:SEQuence <integer>	974
[:SENSe]:EVM:ULINK:PROFile:AUTO:PUSCh:DMRS:SEQuence?	974
[:SENSe]:EVM:ULINK:PROFile:AUTO:PUSCh:DMRS:TWO <integer>	950
[:SENSe]:EVM:ULINK:PROFile:AUTO:PUSCh:DMRS:TWO?	950
[:SENSe]:EVM:ULINK:PROFile:AUTO:PUSCh:DSS <integer>	951
[:SENSe]:EVM:ULINK:PROFile:AUTO:PUSCh:DSS?	951
[:SENSe]:EVM:ULINK:PROFile:AUTO:PUSCh:FHOPping OFF T1HSF00 T1HSF00 T1HSF01 T1HSF10 T1HSF10 T1HSF10 T2ISF T2IISF	953

List of Commands

[:SENSe]:EVM:ULINK:PROFile:AUTO:PUSCh:FHOPping?	953
[:SENSe]:EVM:ULINK:PROFile:AUTO:PUSCh:MODulation:TYPE QPSK QAM16 QAM64	967
[:SENSe]:EVM:ULINK:PROFile:AUTO:PUSCh:MODulation:TYPE?	967
[:SENSe]:EVM:ULINK:PROFile:AUTO:PUSCh:NRBHo <integer>	956
[:SENSe]:EVM:ULINK:PROFile:AUTO:PUSCh:NRBHo?	956
[:SENSe]:EVM:ULINK:PROFile:AUTO:PUSCh:NSB <integer>	958
[:SENSe]:EVM:ULINK:PROFile:AUTO:PUSCh:NSB?	958
[:SENSe]:EVM:ULINK:PROFile:AUTO:PUSCh:PWRBoost <rel_ampl>	970
[:SENSe]:EVM:ULINK:PROFile:AUTO:PUSCh:PWRBoost?	970
[:SENSe]:EVM:ULINK:PROFile:AUTO:PUSCh:RB:END <integer>	964
[:SENSe]:EVM:ULINK:PROFile:AUTO:PUSCh:RB:END?	964
[:SENSe]:EVM:ULINK:PROFile:AUTO:PUSCh:RB:STARt <integer>	962
[:SENSe]:EVM:ULINK:PROFile:AUTO:PUSCh:RB:STARt?	962
[:SENSe]:EVM:ULINK:PROFile:AUTO:PUSCh:SSLot <integer>	960
[:SENSe]:EVM:ULINK:PROFile:AUTO:PUSCh:SSLot?	960
[:SENSe]:EVM:ULINK:PROFile:AUTO:PUSCh:SSLot:AUTO OFF ON 0 1	960
[:SENSe]:EVM:ULINK:PROFile:AUTO:PUSCh:SSLot:AUTO?	960
[:SENSe]:EVM:ULINK:PROFile:AUTO:RNTI <integer>	940
[:SENSe]:EVM:ULINK:PROFile:AUTO:RNTI?	940
[:SENSe]:EVM:ULINK:PROFile:AUTO:SFNumber <integer>	941
[:SENSe]:EVM:ULINK:PROFile:AUTO:SFNumber?	941
[:SENSe]:EVM:ULINK:PROFile:AUTO:SRS INCLude EXCLude	931
[:SENSe]:EVM:ULINK:PROFile:AUTO:SRS?	931
[:SENSe]:EVM:ULINK:PROFile:AUTO:SRS:ACTive OFF ON 0 1	1054
[:SENSe]:EVM:ULINK:PROFile:AUTO:SRS:ACTive?	1054
[:SENSe]:EVM:ULINK:PROFile:AUTO:SRS:BCONfig <integer>	1056
[:SENSe]:EVM:ULINK:PROFile:AUTO:SRS:BCONfig?	1056
[:SENSe]:EVM:ULINK:PROFile:AUTO:SRS:BWIDth <integer>	1058
[:SENSe]:EVM:ULINK:PROFile:AUTO:SRS:BWIDth?	1058
[:SENSe]:EVM:ULINK:PROFile:AUTO:SRS:CINDeX <integer>	1066
[:SENSe]:EVM:ULINK:PROFile:AUTO:SRS:CINDeX?	1066

List of Commands

[[:SENSe]:EVM:ULINK:PROFile:AUTO:SRS:CSHift <integer>	1055
[[:SENSe]:EVM:ULINK:PROFile:AUTO:SRS:CSHift?	1055
[[:SENSe]:EVM:ULINK:PROFile:AUTO:SRS:FDPosition <integer>.	1062
[[:SENSe]:EVM:ULINK:PROFile:AUTO:SRS:FDPosition?	1062
[[:SENSe]:EVM:ULINK:PROFile:AUTO:SRS:HBWidth <integer>	1060
[[:SENSe]:EVM:ULINK:PROFile:AUTO:SRS:HBWidth?	1060
[[:SENSe]:EVM:ULINK:PROFile:AUTO:SRS:MUPTs OFF ON 0 1.	1069
[[:SENSe]:EVM:ULINK:PROFile:AUTO:SRS:MUPTs?	1069
[[:SENSe]:EVM:ULINK:PROFile:AUTO:SRS:NRA:SONe <integer>	1070
[[:SENSe]:EVM:ULINK:PROFile:AUTO:SRS:NRA:SONe?	1070
[[:SENSe]:EVM:ULINK:PROFile:AUTO:SRS:NRA:SSIX <integer>.	1071
[[:SENSe]:EVM:ULINK:PROFile:AUTO:SRS:NRA:SSIX?	1071
[[:SENSe]:EVM:ULINK:PROFile:AUTO:SRS:PWRBoost <rel_amp>	1064
[[:SENSe]:EVM:ULINK:PROFile:AUTO:SRS:PWRBoost?	1064
[[:SENSe]:EVM:ULINK:PROFile:AUTO:SRS:SFConfig <integer>	1063
[[:SENSe]:EVM:ULINK:PROFile:AUTO:SRS:SFConfig?	1063
[[:SENSe]:EVM:ULINK:PROFile:AUTO:SRS:SSLot <integer>.	1068
[[:SENSe]:EVM:ULINK:PROFile:AUTO:SRS:SSLot?	1068
[[:SENSe]:EVM:ULINK:PROFile:AUTO:SRS:SSLot:AUTO OFF ON 0 1.	1068
[[:SENSe]:EVM:ULINK:PROFile:AUTO:SRS:SSLot:AUTO?	1068
[[:SENSe]:EVM:ULINK:PROFile:AUTO:SRS:TCOMb <integer>	1059
[[:SENSe]:EVM:ULINK:PROFile:AUTO:SRS:TCOMb?	1059
[[:SENSe]:EVM:ULINK:PROFile:CLear	1079
[[:SENSe]:EVM:ULINK:PROFile:COUNt?	1079
[[:SENSe]:EVM:ULINK:PROFile:EXCLude:ALL.	922
[[:SENSe]:EVM:ULINK:PROFile:IGNore	1079
[[:SENSe]:EVM:ULINK:PROFile:INCLude:ALL	922
[[:SENSe]:EVM:ULINK:PROFile:UPDate	1079
[[:SENSe]:EVM:ULINK:PROFile:USER<n>:CID <integer>.	938
[[:SENSe]:EVM:ULINK:PROFile:USER<n>:CID?	938
[[:SENSe]:EVM:ULINK:PROFile:USER<n>:DELete	937

List of Commands

[::SENSe]:EVM:ULINK:PROFile:USER<n>:HOPPIng:GROUp OFF ON 0 1	942
[::SENSe]:EVM:ULINK:PROFile:USER<n>:HOPPIng:GROUp?	942
[::SENSe]:EVM:ULINK:PROFile:USER<n>:HOPPIng:SEQuence OFF ON 0 1	943
[::SENSe]:EVM:ULINK:PROFile:USER<n>:HOPPIng:SEQuence?	943
[::SENSe]:EVM:ULINK:PROFile:USER<n>:PRACH INCLude EXCLude	929
[::SENSe]:EVM:ULINK:PROFile:USER<n>:PRACH?	929
[::SENSe]:EVM:ULINK:PROFile:USER<n>:PRACH:CINdex <integer>	1044
[::SENSe]:EVM:ULINK:PROFile:USER<n>:PRACH:CINdex?	1044
[::SENSe]:EVM:ULINK:PROFile:USER<n>:PRACH:CSSet UNREstricted RESTRicted	1046
[::SENSe]:EVM:ULINK:PROFile:USER<n>:PRACH:CSSet?	1046
[::SENSe]:EVM:ULINK:PROFile:USER<n>:PRACH:LRSindex <integer>	1045
[::SENSe]:EVM:ULINK:PROFile:USER<n>:PRACH:LRSindex?	1045
[::SENSe]:EVM:ULINK:PROFile:USER<n>:PRACH:NCSConfig <integer>	1048
[::SENSe]:EVM:ULINK:PROFile:USER<n>:PRACH:NCSConfig?	1048
[::SENSe]:EVM:ULINK:PROFile:USER<n>:PRACH:NRAPrb <integer>	1042
[::SENSe]:EVM:ULINK:PROFile:USER<n>:PRACH:NRAPrb?	1042
[::SENSe]:EVM:ULINK:PROFile:USER<n>:PRACH:PINdex <integer>	1049
[::SENSe]:EVM:ULINK:PROFile:USER<n>:PRACH:PINdex?	1049
[::SENSe]:EVM:ULINK:PROFile:USER<n>:PRACH:PWRBoost <rel_amp>	1050
[::SENSe]:EVM:ULINK:PROFile:USER<n>:PRACH:PWRBoost?	1050
[::SENSe]:EVM:ULINK:PROFile:USER<n>:PRACH:SRESorce <integer>	1052
[::SENSe]:EVM:ULINK:PROFile:USER<n>:PRACH:SRESorce?	1052
[::SENSe]:EVM:ULINK:PROFile:USER<n>:PUCCh INCLude EXCLude	926
[::SENSe]:EVM:ULINK:PROFile:USER<n>:PUCCh?	926
[::SENSe]:EVM:ULINK:PROFile:USER<n>:PUCCh:ADD:SLOT<integer>	1038
[::SENSe]:EVM:ULINK:PROFile:USER<n>:PUCCh:COUNt?	1080
[::SENSe]:EVM:ULINK:PROFile:USER<n>:PUCCh:CSHift <integer>	1013
[::SENSe]:EVM:ULINK:PROFile:USER<n>:PUCCh:CSHift?	1013
[::SENSe]:EVM:ULINK:PROFile:USER<n>:PUCCh:CSHift:COUPle OFF ON 0 1	1014
[::SENSe]:EVM:ULINK:PROFile:USER<n>:PUCCh:CSHift:COUPle?	1014
[::SENSe]:EVM:ULINK:PROFile:USER<n>:PUCCh:DMRS INCLude EXCLude	928

List of Commands

[:SENSe]:EVM:ULINK:PROFile:USER<n>:PUCCh:DMRS?	928
[:SENSe]:EVM:ULINK:PROFile:USER<n>:PUCCh:DMRS:GROup <integer>	1020
[:SENSe]:EVM:ULINK:PROFile:USER<n>:PUCCh:DMRS:GROup?	1020
[:SENSe]:EVM:ULINK:PROFile:USER<n>:PUCCh:DMRS:GROup:COUPle OFF ON 0 1	1022
[:SENSe]:EVM:ULINK:PROFile:USER<n>:PUCCh:DMRS:GROup:COUPle?	1022
[:SENSe]:EVM:ULINK:PROFile:USER<n>:PUCCh:DMRS:PARams OFF ON 0 1	995
[:SENSe]:EVM:ULINK:PROFile:USER<n>:PUCCh:DMRS:PARams?	995
[:SENSe]:EVM:ULINK:PROFile:USER<n>:PUCCh:DMRS:PWRBoost <rel_amp>	1023
[:SENSe]:EVM:ULINK:PROFile:USER<n>:PUCCh:DMRS:PWRBoost?	1023
[:SENSe]:EVM:ULINK:PROFile:USER<n>:PUCCh:DMRS:PWRBoost:COUPle OFF ON 0 1	1024
[:SENSe]:EVM:ULINK:PROFile:USER<n>:PUCCh:DMRS:PWRBoost:COUPle?	1024
[:SENSe]:EVM:ULINK:PROFile:USER<n>:PUCCh:FORMat T1 T1A T1B T2 T2A T2B T1S T1AS T1BS ..	1009
[:SENSe]:EVM:ULINK:PROFile:USER<n>:PUCCh:FORMat?	1009
[:SENSe]:EVM:ULINK:PROFile:USER<n>:PUCCh:FORMat:COUPle OFF ON 0 1	1012
[:SENSe]:EVM:ULINK:PROFile:USER<n>:PUCCh:FORMat:COUPle?	1012
[:SENSe]:EVM:ULINK:PROFile:USER<n>:PUCCh:NCS:ONE <integer>	999
[:SENSe]:EVM:ULINK:PROFile:USER<n>:PUCCh:NCS:ONE?	999
[:SENSe]:EVM:ULINK:PROFile:USER<n>:PUCCh:N:ONE <integer>	1025
[:SENSe]:EVM:ULINK:PROFile:USER<n>:PUCCh:N:ONE?	1025
[:SENSe]:EVM:ULINK:PROFile:USER<n>:PUCCh:N:ONE:COUPle OFF ON 0 1	1026
[:SENSe]:EVM:ULINK:PROFile:USER<n>:PUCCh:N:ONE:COUPle?	1026
[:SENSe]:EVM:ULINK:PROFile:USER<n>:PUCCh:NRB:TWO <integer>	997
[:SENSe]:EVM:ULINK:PROFile:USER<n>:PUCCh:NRB:TWO?	997
[:SENSe]:EVM:ULINK:PROFile:USER<n>:PUCCh:N:TWO <integer>	1000
[:SENSe]:EVM:ULINK:PROFile:USER<n>:PUCCh:N:TWO?	1000
[:SENSe]:EVM:ULINK:PROFile:USER<n>:PUCCh:OS INDEx0 INDEx1 INDEx2	1015
[:SENSe]:EVM:ULINK:PROFile:USER<n>:PUCCh:OS?	1015
[:SENSe]:EVM:ULINK:PROFile:USER<n>:PUCCh:OS:COUPle OFF ON 0 1 [:SENSe]:EVM:ULINK:PRO- File:USER<n>:PUCCh:OS:COUPle?	1017
[:SENSe]:EVM:ULINK:PROFile:USER<n>:PUCCh:PWRBoost <rel_amp>	1018
[:SENSe]:EVM:ULINK:PROFile:USER<n>:PUCCh:PWRBoost?	1018

List of Commands

[::SENSe]:EVM:ULINK:PROFile:USER<n>:PUCCh:PWRBoost:COUPlE OFF ON 0 1	1020
[::SENSe]:EVM:ULINK:PROFile:USER<n>:PUCCh:PWRBoost:COUPlE?	1020
[::SENSe]:EVM:ULINK:PROFile:USER<n>:PUCCh:RB <integer>	1006
[::SENSe]:EVM:ULINK:PROFile:USER<n>:PUCCh:RB?	1006
[::SENSe]:EVM:ULINK:PROFile:USER<n>:PUCCh:RB:COUPlE OFF ON 0 1	1008
[::SENSe]:EVM:ULINK:PROFile:USER<n>:PUCCh:RB:COUPlE?	1008
[::SENSe]:EVM:ULINK:PROFile:USER<n>:PUCCh:SHIFt <integer>	1002
[::SENSe]:EVM:ULINK:PROFile:USER<n>:PUCCh:SHIFt?	1002
[::SENSe]:EVM:ULINK:PROFile:USER<n>:PUCCh:SLOT<m>:CSHift <integer>	1031
[::SENSe]:EVM:ULINK:PROFile:USER<n>:PUCCh:SLOT<m>:CSHift?	1031
[::SENSe]:EVM:ULINK:PROFile:USER<n>:PUCCh:SLOT<m>:DELete	1039
[::SENSe]:EVM:ULINK:PROFile:USER<n>:PUCCh:SLOT<m>:DMRS:GROUp <integer>	1035
[::SENSe]:EVM:ULINK:PROFile:USER<n>:PUCCh:SLOT<m>:DMRS:GROUp?	1035
[::SENSe]:EVM:ULINK:PROFile:USER<n>:PUCCh:SLOT<m>:DMRS:PWRBoost <rel_ampl>	1036
[::SENSe]:EVM:ULINK:PROFile:USER<n>:PUCCh:SLOT<m>:DMRS:PWRBoost?	1036
[::SENSe]:EVM:ULINK:PROFile:USER<n>:PUCCh:SLOT<m>:FORMat T1 T1A T1B T2 T2A T2B T1S T1AS T1BS	1028
[::SENSe]:EVM:ULINK:PROFile:USER<n>:PUCCh:SLOT<m>:FORMat?	1028
[::SENSe]:EVM:ULINK:PROFile:USER<n>:PUCCh:SLOT<m>:N:ONE <integer>	1037
[::SENSe]:EVM:ULINK:PROFile:USER<n>:PUCCh:SLOT<m>:N:ONE?	1037
[::SENSe]:EVM:ULINK:PROFile:USER<n>:PUCCh:SLOT<m>:OS INDEx0 INDEx1 INDEx2	1032
[::SENSe]:EVM:ULINK:PROFile:USER<n>:PUCCh:SLOT<m>:OS?	1032
[::SENSe]:EVM:ULINK:PROFile:USER<n>:PUCCh:SLOT<m>:POSition?	1040
[::SENSe]:EVM:ULINK:PROFile:USER<n>:PUCCh:SLOT<m>:PWRBoost <rel_ampl>	1034
[::SENSe]:EVM:ULINK:PROFile:USER<n>:PUCCh:SLOT<m>:PWRBoost?	1034
[::SENSe]:EVM:ULINK:PROFile:USER<n>:PUCCh:SLOT<m>:RB <integer>	1027
[::SENSe]:EVM:ULINK:PROFile:USER<n>:PUCCh:SLOT<m>:RB?	1027
[::SENSe]:EVM:ULINK:PROFile:USER<n>:PUCCh:SSLot <integer>	1003
[::SENSe]:EVM:ULINK:PROFile:USER<n>:PUCCh:SSLot?	1003
[::SENSe]:EVM:ULINK:PROFile:USER<n>:PUCCh:SSLot:AUTO OFF ON 0 1	1003
[::SENSe]:EVM:ULINK:PROFile:USER<n>:PUCCh:SSLot:AUTO?	1003

List of Commands

[[:SENSe]:EVM:ULINK:PROFile:USER<n>:PUSCh: FHOPping OFF T1ISF00 T1IISF00 T1ISF01 T1IISF01 T1ISF10 T1IISF10 T2ISF T2IISF	953
[[:SENSe]:EVM:ULINK:PROFile:USER<n>:PUSCh INCLude EXCLude	924
[[:SENSe]:EVM:ULINK:PROFile:USER<n>:PUSCh?	924
[[:SENSe]:EVM:ULINK:PROFile:USER<n>:PUSCh:ADD:SLOT <integer>	991
[[:SENSe]:EVM:ULINK:PROFile:USER<n>:PUSCh:COUNt?	1080
[[:SENSe]:EVM:ULINK:PROFile:USER<n>:PUSCh:CTNB EVEN ODD	980
[[:SENSe]:EVM:ULINK:PROFile:USER<n>:PUSCh:CTNB?	980
[[:SENSe]:EVM:ULINK:PROFile:USER<n>:PUSCh:CTNB:COUPlE OFF ON 0 1	981
[[:SENSe]:EVM:ULINK:PROFile:USER<n>:PUSCh:CTNB:COUPlE?	981
[[:SENSe]:EVM:ULINK:PROFile:USER<n>:PUSCh:DMRS INCLude EXCLude	925
[[:SENSe]:EVM:ULINK:PROFile:USER<n>:PUSCh:DMRS?	925
[[:SENSe]:EVM:ULINK:PROFile:USER<n>:PUSCh:DMRS:CSHift <integer>	976
[[:SENSe]:EVM:ULINK:PROFile:USER<n>:PUSCh:DMRS:CSHift?	976
[[:SENSe]:EVM:ULINK:PROFile:USER<n>:PUSCh:DMRS:CSHift:COUPlE OFF ON 0 1	977
[[:SENSe]:EVM:ULINK:PROFile:USER<n>:PUSCh:DMRS:CSHift:COUPlE?	977
[[:SENSe]:EVM:ULINK:PROFile:USER<n>:PUSCh:DMRS:GRoup <integer>	971
[[:SENSe]:EVM:ULINK:PROFile:USER<n>:PUSCh:DMRS:GRoup?	971
[[:SENSe]:EVM:ULINK:PROFile:USER<n>:PUSCh:DMRS:GRoup:COUPlE OFF ON 0 1	973
[[:SENSe]:EVM:ULINK:PROFile:USER<n>:PUSCh:DMRS:GRoup:COUPlE?	973
[[:SENSe]:EVM:ULINK:PROFile:USER<n>:PUSCh:DMRS:ONE <integer>	947
[[:SENSe]:EVM:ULINK:PROFile:USER<n>:PUSCh:DMRS:ONE?	947
[[:SENSe]:EVM:ULINK:PROFile:USER<n>:PUSCh:DMRS:PARAmS OFF ON 0 1	946
[[:SENSe]:EVM:ULINK:PROFile:USER<n>:PUSCh:DMRS:PARAmS?	946
[[:SENSe]:EVM:ULINK:PROFile:USER<n>:PUSCh:DMRS:PWRBoost <rel_ampl>	978
[[:SENSe]:EVM:ULINK:PROFile:USER<n>:PUSCh:DMRS:PWRBoost?	978
[[:SENSe]:EVM:ULINK:PROFile:USER<n>:PUSCh:DMRS:PWRBoost:COUPlE OFF ON 0 1	980
[[:SENSe]:EVM:ULINK:PROFile:USER<n>:PUSCh:DMRS:PWRBoost:COUPlE	980
[[:SENSe]:EVM:ULINK:PROFile:USER<n>:PUSCh:DMRS:SEQuence <integer>	973
[[:SENSe]:EVM:ULINK:PROFile:USER<n>:PUSCh:DMRS:SEQuence?	973
[[:SENSe]:EVM:ULINK:PROFile:USER<n>:PUSCh:DMRS:SEQuence:COUPlE OFF ON 0 1	975

List of Commands

[::SENSe]:EVM:ULINK:PROFile:USER<n>:PUSCh:DMRS:SEQuence:COUPle?	975
[::SENSe]:EVM:ULINK:PROFile:USER<n>:PUSCh:DMRS:TWO <integer>	949
[::SENSe]:EVM:ULINK:PROFile:USER<n>:PUSCh:DMRS:TWO?	949
[::SENSe]:EVM:ULINK:PROFile:USER<n>:PUSCh:DSS <integer>.	950
[::SENSe]:EVM:ULINK:PROFile:USER<n>:PUSCh:DSS?	950
[::SENSe]:EVM:ULINK:PROFile:USER<n>:PUSCh:FHOPping?	953
[::SENSe]:EVM:ULINK:PROFile:USER<n>:PUSCh:MODulation:TYPE QPSK QAM16 QAM64	966
[::SENSe]:EVM:ULINK:PROFile:USER<n>:PUSCh:MODulation:TYPE?	966
[::SENSe]:EVM:ULINK:PROFile:USER<n>:PUSCh:MODulation:TYPE:COUPle OFF ON 0 1	968
[::SENSe]:EVM:ULINK:PROFile:USER<n>:PUSCh:MODulation:TYPE:COUPle?	968
[::SENSe]:EVM:ULINK:PROFile:USER<n>:PUSCh:NRBHo:<integer>.	955
[::SENSe]:EVM:ULINK:PROFile:USER<n>:PUSCh:NRBHo?	955
[::SENSe]:EVM:ULINK:PROFile:USER<n>:PUSCh:NSB <integer>	957
[::SENSe]:EVM:ULINK:PROFile:USER<n>:PUSCh:NSB?.	957
[::SENSe]:EVM:ULINK:PROFile:USER<n>:PUSCh:PWRBoost <rel_ampl>.	969
[::SENSe]:EVM:ULINK:PROFile:USER<n>:PUSCh:PWRBoost?	969
[::SENSe]:EVM:ULINK:PROFile:USER<n>:PUSCh:PWRBoost:COUPle OFF ON 0 1	970
[::SENSe]:EVM:ULINK:PROFile:USER<n>:PUSCh:PWRBoost:COUPle	970
[::SENSe]:EVM:ULINK:PROFile:USER<n>:PUSCh:RB:END <integer>	963
[::SENSe]:EVM:ULINK:PROFile:USER<n>:PUSCh:RB:END?	963
[::SENSe]:EVM:ULINK:PROFile:USER<n>:PUSCh:RB:END:COUPle OFF ON 0 1	965
[::SENSe]:EVM:ULINK:PROFile:USER<n>:PUSCh:RB:END:COUPle?	965
[::SENSe]:EVM:ULINK:PROFile:USER<n>:PUSCh:RB:START <integer>	961
[::SENSe]:EVM:ULINK:PROFile:USER<n>:PUSCh:RB:START?	961
[::SENSe]:EVM:ULINK:PROFile:USER<n>:PUSCh:RB:START:COUPle OFF ON 0 1	963
[::SENSe]:EVM:ULINK:PROFile:USER<n>:PUSCh:RB:START:COUPle?.	963
[::SENSe]:EVM:ULINK:PROFile:USER<n>:PUSCh:SLOT<m>:CTNB OFF ON 0 1.	990
[::SENSe]:EVM:ULINK:PROFile:USER<n>:PUSCh:SLOT<m>:CTNB?	990
[::SENSe]:EVM:ULINK:PROFile:USER<n>:PUSCh:SLOT<m>:DELete	992
[::SENSe]:EVM:ULINK:PROFile:USER<n>:PUSCh:SLOT<m>:DMRS:CSHift <integer>	988
[::SENSe]:EVM:ULINK:PROFile:USER<n>:PUSCh:SLOT<m>:DMRS:CSHift?	988

List of Commands

[[:SENSe]:EVM:ULINK:PROFile:USER<n>:PUSCh:SLOT<m>:DMRS:GROup <integer>	986
[[:SENSe]:EVM:ULINK:PROFile:USER<n>:PUSCh:SLOT<m>:DMRS:GROup?	986
[[:SENSe]:EVM:ULINK:PROFile:USER<n>:PUSCh:SLOT<m>:DMRS:PWRBoost <rel_ampl>	989
[[:SENSe]:EVM:ULINK:PROFile:USER<n>:PUSCh:SLOT<m>:DMRS:PWRBoost?	989
[[:SENSe]:EVM:ULINK:PROFile:USER<n>:PUSCh:SLOT<m>:DMRS:SEQuence <integer>	987
[[:SENSe]:EVM:ULINK:PROFile:USER<n>:PUSCh:SLOT<m>:DMRS:SEQuence?	987
[[:SENSe]:EVM:ULINK:PROFile:USER<n>:PUSCh:SLOT<m>:MODulation:TYPE QPSK QAM16 QAM64 .	984
[[:SENSe]:EVM:ULINK:PROFile:USER<n>:PUSCh:SLOT<m>:MODulation:TYPE?	984
[[:SENSe]:EVM:ULINK:PROFile:USER<n>:PUSCh:SLOT<m>:POSition?	993
[[:SENSe]:EVM:ULINK:PROFile:USER<n>:PUSCh:SLOT<m>:PWRBoost <rel_ampl>	986
[[:SENSe]:EVM:ULINK:PROFile:USER<n>:PUSCh:SLOT<m>:PWRBoost?	986
[[:SENSe]:EVM:ULINK:PROFile:USER<n>:PUSCh:SLOT<m>:RB:END <integer>	983
[[:SENSe]:EVM:ULINK:PROFile:USER<n>:PUSCh:SLOT<m>:RB:END?	983
[[:SENSe]:EVM:ULINK:PROFile:USER<n>:PUSCh:SLOT<m>:RB:STARt <integer>	982
[[:SENSe]:EVM:ULINK:PROFile:USER<n>:PUSCh:SLOT<m>:RB:STARt?	982
[[:SENSe]:EVM:ULINK:PROFile:USER<n>:PUSCh:SSLot:<integer>	959
[[:SENSe]:EVM:ULINK:PROFile:USER<n>:PUSCh:SSLot?	959
[[:SENSe]:EVM:ULINK:PROFile:USER<n>:PUSCh:SSLot:AUTO OFF ON 0 1	959
[[:SENSe]:EVM:ULINK:PROFile:USER<n>:PUSCh:SSLot:AUTO?	959
[[:SENSe]:EVM:ULINK:PROFile:USER<n>:RNTI <integer>	939
[[:SENSe]:EVM:ULINK:PROFile:USER<n>:RNTI?	939
[[:SENSe]:EVM:ULINK:PROFile:USER<n>:SFNumber <integer>	940
[[:SENSe]:EVM:ULINK:PROFile:USER<n>:SFNumber?	940
[[:SENSe]:EVM:ULINK:PROFile:USER<n>:SRS INCLude EXCLude	930
[[:SENSe]:EVM:ULINK:PROFile:USER<n>:SRS?	930
[[:SENSe]:EVM:ULINK:PROFile:USER<n>:SRS:BCONfig <integer>	1056
[[:SENSe]:EVM:ULINK:PROFile:USER<n>:SRS:BCONfig?	1056
[[:SENSe]:EVM:ULINK:PROFile:USER<n>:SRS:BWIDth <integer>	1057
[[:SENSe]:EVM:ULINK:PROFile:USER<n>:SRS:BWIDth?	1057
[[:SENSe]:EVM:ULINK:PROFile:USER<n>:SRS:CINdex <integer>	1065
[[:SENSe]:EVM:ULINK:PROFile:USER<n>:SRS:CINdex?	1065

List of Commands

[:SENSe]:EVM:ULINK:PROFile:USER<n>:SRS:CSHift <integer>	1055
[:SENSe]:EVM:ULINK:PROFile:USER<n>:SRS:CSHift?	1055
[:SENSe]:EVM:ULINK:PROFile:USER<n>:SRS:FDPosition <integer>	1061
[:SENSe]:EVM:ULINK:PROFile:USER<n>:SRS:FDPosition?	1061
[:SENSe]:EVM:ULINK:PROFile:USER<n>:SRS:HBWidth <integer>	1060
[:SENSe]:EVM:ULINK:PROFile:USER<n>:SRS:HBWidth?	1060
[:SENSe]:EVM:ULINK:PROFile:USER<n>:SRS:MUPTs OFF ON 0 1 [:SENSe]:EVM:ULINK:PROFile:US- ER<n>:SRS:MUPTs?	1068
[:SENSe]:EVM:ULINK:PROFile:USER<n>:SRS:NRA:SONe <integer>	1069
[:SENSe]:EVM:ULINK:PROFile:USER<n>:SRS:NRA:SONe?	1069
[:SENSe]:EVM:ULINK:PROFile:USER<n>:SRS:NRA:SSIX <integer>	1071
[:SENSe]:EVM:ULINK:PROFile:USER<n>:SRS:NRA:SSIX?	1071
[:SENSe]:EVM:ULINK:PROFile:USER<n>:SRS:PWRBoost <rel_amp>	1064
[:SENSe]:EVM:ULINK:PROFile:USER<n>:SRS:PWRBoost?	1064
[:SENSe]:EVM:ULINK:PROFile:USER<n>:SRS:SFCConfig <integer>	1062
[:SENSe]:EVM:ULINK:PROFile:USER<n>:SRS:SFCConfig?	1062
[:SENSe]:EVM:ULINK:PROFile:USER<n>:SRS:SSLot <integer>	1067
[:SENSe]:EVM:ULINK:PROFile:USER<n>:SRS:SSLot?	1067
[:SENSe]:EVM:ULINK:PROFile:USER<n>:SRS:SSLot:AUTO OFF ON 0 1	1067
[:SENSe]:EVM:ULINK:PROFile:USER<n>:SRS:SSLot:AUTO?	1067
[:SENSe]:EVM:ULINK:PROFile:USER<n>:SRS:TCOMb <integer>	1058
[:SENSe]:EVM:ULINK:PROFile:USER<n>:SRS:TCOMb?	1058
[:SENSe]:EVM:ULINK:PROFile:USER1 50:PRACH:ACTive OFF ON 0 1	1041
[:SENSe]:EVM:ULINK:PROFile:USER1 50:PRACH:ACTive?	1041
[:SENSe]:EVM:ULINK:PROFile:USER1 50:PUCCh:ACTive OFF ON 0 1	994
[:SENSe]:EVM:ULINK:PROFile:USER1 50:PUCCh:ACTive?	994
[:SENSe]:EVM:ULINK:PROFile:USER1 50:PUSCh:ACTive OFF ON 0 1	945
[:SENSe]:EVM:ULINK:PROFile:USER1 50:PUSCh:ACTive?	945
[:SENSe]:EVM:ULINK:PROFile:USER1 50:PUSCh:CTNB EVEN ODD	980
[:SENSe]:EVM:ULINK:PROFile:USER1 50:PUSCh:CTNB?	980
[:SENSe]:EVM:ULINK:PROFile:USER1 50:SRS:ACTive OFF ON 0 1	1053

List of Commands

[[:SENSe]:EVM:ULINK:PROFile:USER1 50:SRS:ACTive?	1053
[[:SENSe]:EVM:ULINK:SYNC:CPLength AUTO NORMAl EXTended	1105
[[:SENSe]:EVM:ULINK:SYNC:CPLength?	1105
[[:SENSe]:EVM:ULINK:SYNC:CPLength:AUTO OFF ON 0 1	1105
[[:SENSe]:EVM:ULINK:SYNC:CPLength:AUTO?	1105
[[:SENSe]:EVM:ULINK:SYNC:HSSHift OFF ON 0 1	783
[[:SENSe]:EVM:ULINK:SYNC:HSSHift?	783
[[:SENSe]:EVM:ULINK:SYNC:PDSWap OFF ON 0 1	784
[[:SENSe]:EVM:ULINK:SYNC:PDSWap?	784
[[:SENSe]:EVM:ULINK:SYNC:TYPE RS PUCCh SRS PRACH	781
[[:SENSe]:EVM:ULINK:SYNC:TYPE?	781
[[:SENSe]:EVM:WINDow:LENGth GPP CUSTom	1114
[[:SENSe]:EVM:WINDow:LENGth?	1114
[[:SENSe]:EVM:WINDow:LENGth:CUSTom <int>	1115
[[:SENSe]:EVM:WINDow:LENGth:CUSTom?	1115
[[:SENSe]:FCAPture:BLOCK <integer>	1911
[[:SENSe]:FCAPture:BLOCK?	1911
[[:SENSe]:FCAPture:LENGth <integer>	1909
[[:SENSe]:FCAPture:LENGth?	1909
[[:SENSe]:FCAPture:POINter <integer>	1912
[[:SENSe]:FCAPture:POINter?	1912
[[:SENSe]:FCAPture:WLENGth AUTO BIT32 BIT64	1910
[[:SENSe]:FCAPture:WLENGth?	1910
[[:SENSe]:FEED RF AIQ EMIXer	1282
[[:SENSe]:FEED?	1282
[[:SENSe]:FEED:AREFERENCE REF50 REF4800 OFF	1287
[[:SENSe]:FEED:AREFERENCE?	1287
[[:SENSe]:FEED:DATA INPut STORed	1293
[[:SENSe]:FEED:DATA?	1293
[[:SENSe]:FEED:DATA:STORe	1294
[[:SENSe]:FEED:RF:PORT[:INPut] RFIN RFIN2 RFIO1 RFIO2	1285

List of Commands

[[:SENSe]:FEED:RF:PORT[:INPut]?	1285
[[:SENSe]:FEED:RF:PORT:OUTPut RFOut RFIO1 RFIO2	1311
[[:SENSe]:FEED:RF:PORT:OUTPut?	1311
[[:SENSe]:FREQuency:CENTer <freq>	1274
[[:SENSe]:FREQuency:CENTer <freq>	1771
[[:SENSe]:FREQuency:CENTer?	1274
[[:SENSe]:FREQuency:CENTer?	1771
[[:SENSe]:FREQuency:CENTer:STEP:AUTO OFF ON 0 1	1279
[[:SENSe]:FREQuency:CENTer:STEP:AUTO OFF ON 0 1	1773
[[:SENSe]:FREQuency:CENTer:STEP:AUTO?	1279
[[:SENSe]:FREQuency:CENTer:STEP:AUTO?	1773
[[:SENSe]:FREQuency:CENTer:STEP[:INCRement] <freq>	1279
[[:SENSe]:FREQuency:CENTer:STEP[:INCRement] <freq>	1773
[[:SENSe]:FREQuency:CENTer:STEP[:INCRement]?	1279
[[:SENSe]:FREQuency:CENTer:STEP[:INCRement]?	1773
[[:SENSe]:FREQuency:IQ:CENTer <freq>	1276
[[:SENSe]:FREQuency:IQ:CENTer?	1276
[[:SENSe]:FREQuency:OFFSet <freq>	1280
[[:SENSe]:FREQuency:OFFSet?	1280
[[:SENSe]:FREQuency:RF:CENTer <freq>	1275
[[:SENSe]:FREQuency:RF:CENTer?	1275
[[:SENSe]:FREQuency:SPAN <freq>	1635
[[:SENSe]:FREQuency:SPAN <freq>	1818
[[:SENSe]:FREQuency:SPAN?	1635
[[:SENSe]:FREQuency:SPAN?	1818
[[:SENSe]:FREQuency:SPAN:BANDwidth[:RESolution]:RATio <integer>	1266
[[:SENSe]:FREQuency:SPAN:BANDwidth[:RESolution]:RATio?	1266
[[:SENSe]:FREQuency:SPAN:BANDwidth[:RESolution]:RATio:AUTO OFF ON 0 1	1266
[[:SENSe]:FREQuency:SPAN:BANDwidth[:RESolution]:RATio:AUTO?	1266
[[:SENSe]:FREQuency:SPAN:FULL	1636
[[:SENSe]:FREQuency:SPAN:FULL	1819

List of Commands

[[:SENSe]:FREQuency:SPAN:PREVious	1638
[[:SENSe]:FREQuency:START <freq>	1277
[[:SENSe]:FREQuency:START <freq>	1772
[[:SENSe]:FREQuency:START <freq>	757
[[:SENSe]:FREQuency:START?	1277
[[:SENSe]:FREQuency:START?	1772
[[:SENSe]:FREQuency:START?	757
[[:SENSe]:FREQuency:STOP <freq>	1278
[[:SENSe]:FREQuency:STOP <freq>	1772
[[:SENSe]:FREQuency:STOP <freq>	758
[[:SENSe]:FREQuency:STOP?	1278
[[:SENSe]:FREQuency:STOP?	1772
[[:SENSe]:FREQuency:STOP?	758
[[:SENSe]:FREQuency:SYNThesis:AUTO[:STATe] OFF ON 0 1	1439
[[:SENSe]:FREQuency:SYNThesis:AUTO[:STATe]?	1439
[[:SENSe]:FREQuency:SYNThesis[:STATe] 1 2 3	1438
[[:SENSe]:FREQuency:SYNThesis[:STATe]?	1438
[[:SENSe]:FREQuency:TUNE:IMMEDIATE	1273
[[:SENSe]:IF:GAIN:FFT:AUTO[:STATe] OFF ON 0 1	1446
[[:SENSe]:IF:GAIN:FFT:AUTO[:STATe]?	1446
[[:SENSe]:IF:GAIN:FFT[:STATe] AUTOOrange LOW HIGH	1445
[[:SENSe]:IF:GAIN:FFT[:STATe]?	1445
[[:SENSe]:IF:GAIN:SWEPT:AUTO[:STATe] OFF ON 0 1	1444
[[:SENSe]:IF:GAIN:SWEPT:AUTO[:STATe]?	1444
[[:SENSe]:IF:GAIN:SWEPT[:STATe] OFF ON 0 1	1443
[[:SENSe]:IF:GAIN:SWEPT[:STATe]?	1443
[[:SENSe]:MPADapter:CORRection:CSET[1] 2 3 4 5 6 7 8 9 10 11 12 13 14 15 16:ANTenna[:UNIT] GAUSs PTES- la UVM UAM NOConversion	1323
[[:SENSe]:MPADapter:CORRection:CSET[1] 2 3 4 5 6 7 8 9 10 11 12 13 14 15 16:ANTenna[:UNIT]?	1323
[[:SENSe]:MPADapter:CORRection:CSET[1] 2 3 4 5 6 7 8 9 10 11 12 13 14 15 16:COMMENT "text"	1328
[[:SENSe]:MPADapter:CORRection:CSET[1] 2 3 4 5 6 7 8 9 10 11 12 13 14 15 16:COMMENT?	1328

List of Commands

[:SENSe]:MPADapter:CORRection:CSET[1] 2 3 4 5 6 7 8 9 10 11 12 13 14 15 16:DATA <freq>, <amp>, ...	1343
[:SENSe]:MPADapter:CORRection:CSET[1] 2 3 4 5 6 7 8 9 10 11 12 13 14 15 16:DATA?	1343
[:SENSe]:MPADapter:CORRection:CSET[1] 2 3 4 5 6 7 8 9 10 11 12 13 14 15 16:DATA:MERGe <freq>, <amp>,	1343
[:SENSe]:MPADapter:CORRection:CSET[1] 2 3 4 5 6 7 8 9 10 11 12 13 14 15 16:DELeTe	1341
[:SENSe]:MPADapter:CORRection:CSET[1] 2 3 4 5 6 7 8 9 10 11 12 13 14 15 16:DESCription "text"	1327
[:SENSe]:MPADapter:CORRection:CSET[1] 2 3 4 5 6 7 8 9 10 11 12 13 14 15 16:DESCription?	1327
[:SENSe]:MPADapter:CORRection:CSET[1] 2 3 4 5 6 7 8 9 10 11 12 13 14 15 16:RF:PORT RFIO RFIO1 RFIO2 RFIO3 RFIO4 RFIO5 RFIO6 RFIO7	1328
[:SENSe]:MPADapter:CORRection:CSET[1] 2 3 4 5 6 7 8 9 10 11 12 13 14 15 16:RF:PORT?	1328
[:SENSe]:MPADapter:CORRection:CSET[1] 2 3 4 5 6 7 8 9 10 11 12 13 14 15 16:RF:PORT:RFIO0 SOURce AN- ALyzer BOTH	1329
[:SENSe]:MPADapter:CORRection:CSET[1] 2 3 4 5 6 7 8 9 10 11 12 13 14 15 16:RF:PORT:RFIO0?	1329
[:SENSe]:MPADapter:CORRection:CSET[1] 2 3 4 5 6 7 8 9 10 11 12 13 14 15 16:RF:PORT:RFIO1 SOURce AN- ALyzer BOTH	1330
[:SENSe]:MPADapter:CORRection:CSET[1] 2 3 4 5 6 7 8 9 10 11 12 13 14 15 16:RF:PORT:RFIO1?	1330
[:SENSe]:MPADapter:CORRection:CSET[1] 2 3 4 5 6 7 8 9 10 11 12 13 14 15 16:RF:PORT:RFIO2 SOURce AN- ALyzer BOTH	1331
[:SENSe]:MPADapter:CORRection:CSET[1] 2 3 4 5 6 7 8 9 10 11 12 13 14 15 16:RF:PORT:RFIO2?	1331
[:SENSe]:MPADapter:CORRection:CSET[1] 2 3 4 5 6 7 8 9 10 11 12 13 14 15 16:RF:PORT:RFIO3 SOURce AN- ALyzer BOTH	1333
[:SENSe]:MPADapter:CORRection:CSET[1] 2 3 4 5 6 7 8 9 10 11 12 13 14 15 16:RF:PORT:RFIO3?	1333
[:SENSe]:MPADapter:CORRection:CSET[1] 2 3 4 5 6 7 8 9 10 11 12 13 14 15 16:RF:PORT:RFIO4 SOURce AN- ALyzer BOTH	1334
[:SENSe]:MPADapter:CORRection:CSET[1] 2 3 4 5 6 7 8 9 10 11 12 13 14 15 16:RF:PORT:RFIO4?	1334
[:SENSe]:MPADapter:CORRection:CSET[1] 2 3 4 5 6 7 8 9 10 11 12 13 14 15 16:RF:PORT:RFIO5 SOURce AN- ALyzer BOTH	1335
[:SENSe]:MPADapter:CORRection:CSET[1] 2 3 4 5 6 7 8 9 10 11 12 13 14 15 16:RF:PORT:RFIO5?	1335
[:SENSe]:MPADapter:CORRection:CSET[1] 2 3 4 5 6 7 8 9 10 11 12 13 14 15 16:RF:PORT:RFIO6 SOURce AN- ALyzer BOTH	1336
[:SENSe]:MPADapter:CORRection:CSET[1] 2 3 4 5 6 7 8 9 10 11 12 13 14 15 16:RF:PORT:RFIO6?	1336
[:SENSe]:MPADapter:CORRection:CSET[1] 2 3 4 5 6 7 8 9 10 11 12 13 14 15 16:RF:PORT:RFIO7 SOURce AN- ALyzer BOTH	1338
[:SENSe]:MPADapter:CORRection:CSET[1] 2 3 4 5 6 7 8 9 10 11 12 13 14 15 16:RF:PORT:RFIO7?	1338
[:SENSe]:MPADapter:CORRection:CSET[1] 2 3 4 5 6 7 8 9 10 11 12 13 14 15 16[:STATe] ON OFF 1 0	1322

List of Commands

[[:SENSe]:MPADapter:CORRection:CSET[1] 2 3 4 5 6 7 8 9 10 11 12 13 14 15 16[:STATe]?)	1322
[[:SENSe]:MPADapter:CORRection:CSET[1] 2 3 4 5 6 7 8 9 10 11 12 13 14 15 16:X:SPACing LINear LOGarithmic	1325
[[:SENSe]:MPADapter:CORRection:CSET[1] 2 3 4 5 6 7 8 9 10 11 12 13 14 15 16:X:SPACing?	1325
[[:SENSe]:MPADapter:CORRection:CSET:ALL:DELeTe	1342
[[:SENSe]:MPADapter:CORRection:CSET:ALL[:STATe] ON OFF 1 0	1342
[[:SENSe]:MPADapter:CORRection:CSET:ALL[:STATe]?)	1342
[[:SENSe]:MPADapter:GAIN[:STATe] ON OFF 1 0	1320
[[:SENSe]:MPADapter:GAIN[:STATe]?)	1320
[[:SENSe]:MPADapter:PORT:INPut OFF	1314
[[:SENSe]:MPADapter:PORT:INPut OFF RFIO0 RFIO1 RFIO2 RFIO3 RFIO4 RFIO5 RFIO6 RFIO7	1314
[[:SENSe]:MPADapter:PORT:INPut RFIO0	1315
[[:SENSe]:MPADapter:PORT:INPut?	1314
[[:SENSe]:MPADapter:PORT:OUTPut:BITMap <integer>	1317
[[:SENSe]:MPADapter:PORT:OUTPut:BITMap?	1317
[[:SENSe]:MPADapter[:STATe] ON OFF 1 0	1313
[[:SENSe]:MPADapter[:STATe]?)	1313
[[:SENSe]:OBWidth:AVERAge:COUNT <integer>	421
[[:SENSe]:OBWidth:AVERAge:COUNT?	421
[[:SENSe]:OBWidth:AVERAge[:STATe] ON OFF 1 0	421
[[:SENSe]:OBWidth:AVERAge[:STATe]?)	421
[[:SENSe]:OBWidth:AVERAge:TCONtrol EXPonential REPeat	422
[[:SENSe]:OBWidth:AVERAge:TCONtrol?	422
[[:SENSe]:OBWidth:BANDwidth[:RESolution] <bandwidth>	406
[[:SENSe]:OBWidth:BANDwidth[:RESolution]?)	406
[[:SENSe]:OBWidth:BANDwidth[:RESolution]:AUTO ON OFF 1 0	406
[[:SENSe]:OBWidth:BANDwidth[:RESolution]:AUTO?	406
[[:SENSe]:OBWidth:BANDwidth:SHApe GAUSSian FLATtop	409
[[:SENSe]:OBWidth:BANDwidth:SHApe?	409
[[:SENSe]:OBWidth:BANDwidth:VIDeo <bandwidth>	407
[[:SENSe]:OBWidth:BANDwidth:VIDeo?)	407

List of Commands

[:SENSe]:OBWidth:BANDwidth:VIDeo:AUTO ON OFF 1 0	407
[:SENSe]:OBWidth:BANDwidth:VIDeo:AUTO?	407
[:SENSe]:OBWidth:DETEctor:AUTO ON OFF 1 0	449
[:SENSe]:OBWidth:DETEctor:AUTO?	449
[:SENSe]:OBWidth:DETEctor[:FUNction] NORMal AVERage POSitive SAMPle NEGative	448
[:SENSe]:OBWidth:DETEctor[:FUNction]?	448
[:SENSe]:OBWidth:FREQuency:SPAN <freq>	440
[:SENSe]:OBWidth:FREQuency:SPAN?	440
[:SENSe]:OBWidth:FREQuency:SPAN:FULL	441
[:SENSe]:OBWidth:FREQuency:SPAN:PREVious	441
[:SENSe]:OBWidth:IF:GAIN:AUTO[:STATe] ON OFF 1 0	425
[:SENSe]:OBWidth:IF:GAIN:AUTO[:STATe]?	425
[:SENSe]:OBWidth:IF:GAIN[:STATe] ON OFF 1 0	426
[:SENSe]:OBWidth:IF:GAIN[:STATe]?	426
[:SENSe]:OBWidth:MAXHold ON OFF 1 0	423
[:SENSe]:OBWidth:MAXHold?	423
[:SENSe]:OBWidth:PERCent <real>	423
[:SENSe]:OBWidth:PERCent?	423
[:SENSe]:OBWidth:SWEep:POINts <integer>	446
[:SENSe]:OBWidth:SWEep:POINts?	446
[:SENSe]:OBWidth:SWEep:TIME <time>	443
[:SENSe]:OBWidth:SWEep:TIME?	443
[:SENSe]:OBWidth:SWEep:TIME:AUTO OFF ON 0 1	443
[:SENSe]:OBWidth:SWEep:TIME:AUTO?	443
[:SENSe]:OBWidth:SWEep:TIME:AUTO:RULEs NORMal ACCuracy	444
[:SENSe]:OBWidth:SWEep:TIME:AUTO:RULEs?	444
[:SENSe]:OBWidth:XDB <rel_ampl>	424
[:SENSe]:OBWidth:XDB?	424
[:SENSe]:POWer:IQ[:I]:RANGe[:UPPer] <ampl>	1236
[:SENSe]:POWer:IQ[:I]:RANGe[:UPPer]?	1236
[:SENSe]:POWer:IQ:Q:RANGe[:UPPer] <ampl>	1238

List of Commands

[[:SENSe]:POWer:IQ:Q:RANGe[:UPPer]?	1238
[[:SENSe]:POWer:IQ:RANGe:AUTO OFF ON 0 1	1236
[[:SENSe]:POWer:IQ:RANGe:AUTO?	1236
[[:SENSe]:POWer[:RF]:ATTenuation <rel_amp>	1225
[[:SENSe]:POWer[:RF]:ATTenuation?	1225
[[:SENSe]:POWer[:RF]:ATTenuation:AUTO OFF ON 0 1	1225
[[:SENSe]:POWer[:RF]:ATTenuation:AUTO?	1225
[[:SENSe]:POWer[:RF]:ATTenuation:STEP[:INCRement] 10 dB 2 dB	1233
[[:SENSe]:POWer[:RF]:ATTenuation:STEP[:INCRement]?	1233
[[:SENSe]:POWer[:RF]:EATTenuation <rel_amp>	1230
[[:SENSe]:POWer[:RF]:EATTenuation?	1230
[[:SENSe]:POWer[:RF]:EATTenuation:STATe OFF ON 0 1	1227
[[:SENSe]:POWer[:RF]:EATTenuation:STATe?	1227
[[:SENSe]:POWer[:RF]:GAIN:BAND LOW FULL	1258
[[:SENSe]:POWer[:RF]:GAIN:BAND?	1258
[[:SENSe]:POWer[:RF]:GAIN[:STATe] OFF ON 0 1	1257
[[:SENSe]:POWer[:RF]:GAIN[:STATe]?	1257
[[:SENSe]:POWer[:RF]:MIXer:RANGe[:UPPer] <real>	1234
[[:SENSe]:POWer[:RF]:MIXer:RANGe[:UPPer]?	1234
[[:SENSe]:POWer[:RF]:MW:PATH STD LNPath MPBypass FULL	1253
[[:SENSe]:POWer[:RF]:MW:PATH?	1253
[[:SENSe]:POWer[:RF]:MW:PRESelector[:STATe] ON OFF 0 1	1257
[[:SENSe]:POWer[:RF]:MW:PRESelector[:STATe]?	1257
[[:SENSe]:POWer[:RF]:PADJust <freq>	1243
[[:SENSe]:POWer[:RF]:PADJust?	1243
[[:SENSe]:POWer[:RF]:PADJust:PRESelector MWAVE MMWave EXTernal	1244
[[:SENSe]:POWer[:RF]:PADJust:PRESelector?	1244
[[:SENSe]:POWer[:RF]:PCENter	1242
[[:SENSe]:POWer[:RF]:RANGe <real>	1759
[[:SENSe]:POWer[:RF]:RANGe?	1759
[[:SENSe]:POWer[:RF]:RANGe:AUTO ON OFF 1 0	1232

List of Commands

[[:SENSe]:POWer[:RF]:RANGe:AUTO?	1232
[[:SENSe]:POWer[:RF]:RANGe:OPTimize IMMEDIATE	1231
[[:SENSe]:POWer[:RF]:RANGe:OPTimize:ATTenuation OFF ELEctrical COMBined	1231
[[:SENSe]:POWer[:RF]:RANGe:OPTimize:ATTenuation?	1231
[[:SENSe]:PVTime:AVERage:COUNt <integer>	706
[[:SENSe]:PVTime:AVERage:COUNt?	706
[[:SENSe]:PVTime:AVERage[:STATe] OFF ON 0 1	706
[[:SENSe]:PVTime:AVERage[:STATe]?	706
[[:SENSe]:PVTime:AVERage:TCONtrol EXPonential REPeat	707
[[:SENSe]:PVTime:AVERage:TCONtrol?	707
[[:SENSe]:PVTime:AVERage:TYPE LOG LPOWer RMS POWer	707
[[:SENSe]:PVTime:AVERage:TYPE?	707
[[:SENSe]:PVTime:BANDwidth <freq>	691
[[:SENSe]:PVTime:BANDwidth?	691
[[:SENSe]:PVTime:CORRection:NOISe[:AUTO] OFF ON 0 1	715
[[:SENSe]:PVTime:CORRection:NOISe[:AUTO]?	715
[[:SENSe]:PVTime:CPLength NORMAl EXTended	717
[[:SENSe]:PVTime:CPLength?	717
[[:SENSe]:PVTime:IF:GAIN:AUTO[:STATe] ON OFF 1 0	709
[[:SENSe]:PVTime:IF:GAIN:AUTO[:STATe]?	709
[[:SENSe]:PVTime:IF:GAIN[:STATe] ON OFF 1 0	710
[[:SENSe]:PVTime:IF:GAIN[:STATe]?	710
[[:SENSe]:PVTime:LIMit:POFF:DLINK <real>	712
[[:SENSe]:PVTime:LIMit:POFF:DLINK? [:SENSe]:PVTime:LIMit:POFF:DLINK?	712
[[:SENSe]:PVTime:LIMit:POFF:ULINK <real>	712
[[:SENSe]:PVTime:LIMit:POFF:ULINK? [:SENSe]:PVTime:LIMit:POFF:ULINK?	712
[[:SENSe]:PVTime:LIMit:RAMP:DRTIME <time>	711
[[:SENSe]:PVTime:LIMit:RAMP:DRTIME? [:SENSe]:PVTime:LIMit:RAMP:DRTIME?	711
[[:SENSe]:PVTime:LIMit:RAMP:URTime <time>	711
[[:SENSe]:PVTime:LIMit:RAMP:URTime?	711
[[:SENSe]:PVTime:MEASure OFF PPF0 PPF1 PPF2 PPF3 SRS	717

List of Commands

[[:SENSe]:PVTime:MEASure?	717
[[:SENSe]:PVTime:MINterval <integer>.	716
[[:SENSe]:PVTime:MINterval	716
[[:SENSe]:PVTime:RAMP:SEARch:LENGth <time>.	708
[[:SENSe]:PVTime:RAMP:SEARch:LENGth?	708
[[:SENSe]:PVTime:SLOT TS0 TS1 TS2 TS3 TS4 TS5 TS6 TS7 TS8 TS9 TS10 TS11 TS12 TS13 TS14 TS15 TS16 TS17 TS18 TS19	716
[[:SENSe]:PVTime:SLOT?	716
[[:SENSe]:PVTime:THReshold:DOWN:END <rel_ampl>	714
[[:SENSe]:PVTime:THReshold:DOWN:END?	714
[[:SENSe]:PVTime:THReshold:DOWN:START <rel_ampl>.	714
[[:SENSe]:PVTime:THReshold:DOWN:START?	714
[[:SENSe]:PVTime:THReshold:UP:END <rel_ampl>.	713
[[:SENSe]:PVTime:THReshold:UP:END?	713
[[:SENSe]:PVTime:THReshold:UP:START <rel_ampl>.	713
[[:SENSe]:PVTime:THReshold:UP:START?	713
[[:SENSe]:RADio:STANdard:BANDwidth B1M4 B3M B5M B10M B15M B20M	1467
[[:SENSe]:RADio:STANdard:BANDwidth?	1467
[[:SENSe]:RADio:STANdard:DIRection DLINK ULINK	1467
[[:SENSe]:RADio:STANdard:DIRection?	1467
[[:SENSe]:RADio:STANdard:PRESet B1M4 B3M B5M B10M B15M B20M	1470
[[:SENSe]:ROSCillator:EXTernal:FREQuency <freq>	1310
[[:SENSe]:ROSCillator:EXTernal:FREQuency?	1310
[[:SENSe]:ROSCillator:SOURce INTernal EXTernal.	1308
[[:SENSe]:ROSCillator:SOURce?	1308
[[:SENSe]:ROSCillator:SOURce:TYPE INTernal EXTernal SENSe	1307
[[:SENSe]:ROSCillator:SOURce:TYPE?	1307
[[:SENSe]:SEMAsk:AVERAge:COUNT <integer>.	588
[[:SENSe]:SEMAsk:AVERAge:COUNT?	588
[[:SENSe]:SEMAsk:AVERAge[:STATe] ON OFF 1 0	588
[[:SENSe]:SEMAsk:AVERAge[:STATe]?	588

List of Commands

[[:SENSe]:SEMAsk:BANDwidth[1]2:INTegration <bandwidth>	590
[[:SENSe]:SEMAsk:BANDwidth[1]2:INTegration?	590
[[:SENSe]:SEMAsk:BANDwidth[1]2[:RESolution] <bandwidth>	594
[[:SENSe]:SEMAsk:BANDwidth[1]2[:RESolution]?	594
[[:SENSe]:SEMAsk:BANDwidth[1]2[:RESolution]:AUTO OFF ON 1 0	594
[[:SENSe]:SEMAsk:BANDwidth[1]2[:RESolution]:AUTO?	594
[[:SENSe]:SEMAsk:BANDwidth[1]2:VIDeo <bandwidth>	595
[[:SENSe]:SEMAsk:BANDwidth[1]2:VIDeo?.	595
[[:SENSe]:SEMAsk:BANDwidth[1]2:VIDeo:AUTO OFF ON 1 0	595
[[:SENSe]:SEMAsk:BANDwidth[1]2:VIDeo:AUTO?.	595
[[:SENSe]:SEMAsk:BANDwidth[1]2:VIDeo:RATio <real>	596
[[:SENSe]:SEMAsk:BANDwidth[1]2:VIDeo:RATio:AUTO OFF ON 1 0	596
[[:SENSe]:SEMAsk:BANDwidth[1]2:VIDeo:RATio:AUTO?.	596
[[:SENSe]:SEMAsk:BANDwidth[1]2:VIDeo:RATio	596
[[:SENSe]:SEMAsk:BANDwidth:SHAPE ASENse GAUSSian FLATtop.	576
[[:SENSe]:SEMAsk:BANDwidth:SHAPE?	576
[[:SENSe]:SEMAsk:CARRier:AUTO[:STATe] OFF ON 1 0	597
[[:SENSe]:SEMAsk:CARRier:AUTO[:STATe]?	597
[[:SENSe]:SEMAsk:CARRier:CPSD <real>.	598
[[:SENSe]:SEMAsk:CARRier:CPSD?.	598
[[:SENSe]:SEMAsk:CARRier:PEAK[:POWer] <real>.	599
[[:SENSe]:SEMAsk:CARRier:PEAK[:POWer]?	599
[[:SENSe]:SEMAsk:CARRier[:POWer] <real>.	597
[[:SENSe]:SEMAsk:CARRier[:POWer]?	597
[[:SENSe]:SEMAsk:DETEctor:CARRier:AUTO ON OFF 1 0	648
[[:SENSe]:SEMAsk:DETEctor:CARRier:AUTO?.	648
[[:SENSe]:SEMAsk:DETEctor:CARRier[:FUNction] AVERAge NEGAtive NORMAl POSitive SAMPle	647
[[:SENSe]:SEMAsk:DETEctor:CARRier[:FUNction]?	647
[[:SENSe]:SEMAsk:DETEctor:OFFSet:AUTO ON OFF 1 0.	650
[[:SENSe]:SEMAsk:DETEctor:OFFSet:AUTO?	650
[[:SENSe]:SEMAsk:DETEctor:OFFSet[:FUNction] AVERAge NEGAtive NORMAl POSitive SAMPle	649

List of Commands

[[:SENSe]:SEMAsk:DETEctor:OFFSet[:FUNction]?	649
[[:SENSe]:SEMAsk:FILTer[:RRC]:ALPHa <real>	625
[[:SENSe]:SEMAsk:FILTer[:RRC]:ALPHa?	625
[[:SENSe]:SEMAsk:FILTer[:RRC][:STATe] OFF ON 0 1	624
[[:SENSe]:SEMAsk:FILTer[:RRC][:STATe]?	624
[[:SENSe]:SEMAsk:FREQuency[1] 2:SPAN <freq>	591
[[:SENSe]:SEMAsk:FREQuency[1] 2:SPAN?	591
[[:SENSe]:SEMAsk:LIMits STD MAN	626
[[:SENSe]:SEMAsk:LIMits?	626
[[:SENSe]:SEMAsk:OFFSet[1] 2:LIST:BANDwidth:IMULti <integer>,	609
[[:SENSe]:SEMAsk:OFFSet[1] 2:LIST:BANDwidth:IMULti?	609
[[:SENSe]:SEMAsk:OFFSet[1] 2:LIST:BANDwidth[:RESolution] <bandwidth>,	607
[[:SENSe]:SEMAsk:OFFSet[1] 2:LIST:BANDwidth[:RESolution]?	607
[[:SENSe]:SEMAsk:OFFSet[1] 2:LIST:BANDwidth[:RESolution]:AUTO OFF ON 1 0,	607
[[:SENSe]:SEMAsk:OFFSet[1] 2:LIST:BANDwidth[:RESolution]:AUTO?	607
[[:SENSe]:SEMAsk:OFFSet[1] 2:LIST:BANDwidth:VIDeo <freq>,	610
[[:SENSe]:SEMAsk:OFFSet[1] 2:LIST:BANDwidth:VIDeo?	610
[[:SENSe]:SEMAsk:OFFSet[1] 2:LIST:BANDwidth:VIDeo:AUTO OFF ON 0 1,	610
[[:SENSe]:SEMAsk:OFFSet[1] 2:LIST:BANDwidth:VIDeo:AUTO?	610
[[:SENSe]:SEMAsk:OFFSet[1] 2:LIST:BANDwidth:VIDeo:RATio <real>,	611
[[:SENSe]:SEMAsk:OFFSet[1] 2:LIST:BANDwidth:VIDeo:RATio?	611
[[:SENSe]:SEMAsk:OFFSet[1] 2:LIST:BANDwidth:VIDeo:RATio:AUTO OFF ON 0 1,	611
[[:SENSe]:SEMAsk:OFFSet[1] 2:LIST:BANDwidth:VIDeo:RATio:AUTO?	611
[[:SENSe]:SEMAsk:OFFSet[1] 2:LIST:FREQuency:STARt <freq>,	600
[[:SENSe]:SEMAsk:OFFSet[1] 2:LIST:FREQuency:STARt?	600
[[:SENSe]:SEMAsk:OFFSet[1] 2:LIST:FREQuency:STOP <freq>,	602
[[:SENSe]:SEMAsk:OFFSet[1] 2:LIST:FREQuency:STOP?	602
[[:SENSe]:SEMAsk:OFFSet[1] 2:LIST:SIDE BOTH NEGative POSitive,	606
[[:SENSe]:SEMAsk:OFFSet[1] 2:LIST:SIDE?	606
[[:SENSe]:SEMAsk:OFFSet[1] 2:LIST:STARt:ABSolute <real>,	612
[[:SENSe]:SEMAsk:OFFSet[1] 2:LIST:STARt:ABSolute?	612

List of Commands

[[:SENSe]:SEMAsk:OFFSet[1]]2:LIST:STARt:RCARrier <rel_ampl>, ...	617
[[:SENSe]:SEMAsk:OFFSet[1]]2:LIST:STARt:RCARrier?	617
[[:SENSe]:SEMAsk:OFFSet[1]]2:LIST:STATe ON OFF 1 0, ...	600
[[:SENSe]:SEMAsk:OFFSet[1]]2:LIST:STATe?	600
[[:SENSe]:SEMAsk:OFFSet[1]]2:LIST:STOP:ABSolute <real>, ...	614
[[:SENSe]:SEMAsk:OFFSet[1]]2:LIST:STOP:ABSolute?	614
[[:SENSe]:SEMAsk:OFFSet[1]]2:LIST:STOP:ABSolute:COUPle ON OFF 1 0, ...	614
[[:SENSe]:SEMAsk:OFFSet[1]]2:LIST:STOP:ABSolute:COUPle?	614
[[:SENSe]:SEMAsk:OFFSet[1]]2:LIST:STOP:RCARrier <rel_ampl>, ...	618
[[:SENSe]:SEMAsk:OFFSet[1]]2:LIST:STOP:RCARrier?	618
[[:SENSe]:SEMAsk:OFFSet[1]]2:LIST:STOP:RCARrier:COUPle ON OFF 1 0, ...	618
[[:SENSe]:SEMAsk:OFFSet[1]]2:LIST:STOP:RCARrier:COUPle?	618
[[:SENSe]:SEMAsk:OFFSet[1]]2:LIST:SWEEp:TIME <time>, ...	605
[[:SENSe]:SEMAsk:OFFSet[1]]2:LIST:SWEEp:TIME?	605
[[:SENSe]:SEMAsk:OFFSet[1]]2:LIST:SWEEp:TIME:AUTO ON OFF 1 0, ...	605
[[:SENSe]:SEMAsk:OFFSet[1]]2:LIST:SWEEp:TIME:AUTO?	605
[[:SENSe]:SEMAsk:OFFSet[1]]2:LIST:TEST ABSolute AND OR RELative, ...	621
[[:SENSe]:SEMAsk:OFFSet[1]]2:LIST:TEST?	621
[[:SENSe]:SEMAsk:OFFSet[1]]2:TYPE CTOCenter CTOEdge ETOCenter ETOEdge	623
[[:SENSe]:SEMAsk:OFFSet[1]]2:TYPE?	623
[[:SENSe]:SEMAsk:SWEEp[1]]2:TIME <time>	592
[[:SENSe]:SEMAsk:SWEEp[1]]2:TIME?	592
[[:SENSe]:SEMAsk:SWEEp[1]]2:TIME:AUTO OFF 0 ON 1	592
[[:SENSe]:SEMAsk:SWEEp[1]]2:TIME:AUTO?	592
[[:SENSe]:SEMAsk:T80Mask:AUTO ON OFF 1 0 [[:SENSe]:SEMAsk:T80Mask:AUTO?	626
[[:SENSe]:SEMAsk:TYPE ?	589
[[:SENSe]:SEMAsk:TYPE PSDRef TPRef SPRef	589
[[:SENSe]:SPECtrum NORMal INVert.	1468
[[:SENSe]:SPECtrum?	1468
[[:SENSe]:SWEEp:EGATe:CONTRol EDGE LEVel	1659
[[:SENSe]:SWEEp:EGATe:CONTRol?	1659

List of Commands

[[:SENSe]:SWEep:EGATe:DELay <time>	1655
[[:SENSe]:SWEep:EGATe:DELay?	1655
[[:SENSe]:SWEep:EGATe:DELay:COMPensation:TYPE OFF SETTled GDELay	1661
[[:SENSe]:SWEep:EGATe:DELay:COMPensation:TYPE?	1661
[[:SENSe]:SWEep:EGATe:HOLDoff <time>	1660
[[:SENSe]:SWEep:EGATe:HOLDoff?	1660
[[:SENSe]:SWEep:EGATe:HOLDoff:AUTO OFF ON 0 1	1660
[[:SENSe]:SWEep:EGATe:HOLDoff:AUTO?	1660
[[:SENSe]:SWEep:EGATe:LENGth <time>	1656
[[:SENSe]:SWEep:EGATe:LENGth?	1656
[[:SENSe]:SWEep:EGATe:METHod LO VIDeo FFT	1657
[[:SENSe]:SWEep:EGATe:METHod?	1657
[[:SENSe]:SWEep:EGATe:MINFast?	1663
[[:SENSe]:SWEep:EGATe:SOURce EXTernal1 EXTernal2 LINE FRAME RFBurst	1659
[[:SENSe]:SWEep:EGATe:SOURce?	1659
[[:SENSe]:SWEep:EGATe[:STATe] OFF ON 0 1	1652
[[:SENSe]:SWEep:EGATe[:STATe]?	1652
[[:SENSe]:SWEep:EGATe:TIME <time>	1655
[[:SENSe]:SWEep:EGATe:TIME?	1655
[[:SENSe]:SWEep:EGATe:VIEW ON OFF 1 0	1653
[[:SENSe]:SWEep:EGATe:VIEW?	1653
[[:SENSe]:SWEep:FFT:WIDTh <real>	1648
[[:SENSe]:SWEep:FFT:WIDTh?	1648
[[:SENSe]:SWEep:FFT:WIDTh:AUTO OFF ON 0 1	1649
[[:SENSe]:SWEep:FFT:WIDTh:AUTO?	1649
[[:SENSe]:SWEep:POINts <integer>	1663
[[:SENSe]:SWEep:POINts?	1663
[[:SENSe]:SWEep:TIME <time>	1639
[[:SENSe]:SWEep:TIME?	1639
[[:SENSe]:SWEep:TIME:AUTO OFF ON 0 1	1639
[[:SENSe]:SWEep:TIME:AUTO?	1639

List of Commands

[:SENSe]:SWEep:TIME:AUTO:RULEs NORMal ACCuracy SRESponse	1641
[:SENSe]:SWEep:TIME:AUTO:RULEs?	1641
[:SENSe]:SWEep:TIME:AUTO:RULEs:AUTO[:STATe] ON OFF 1 0	1643
[:SENSe]:SWEep:TIME:AUTO:RULEs:AUTO[:STATe]?	1643
[:SENSe]:SWEep:TYPE FFT SWEep	1644
[:SENSe]:SWEep:TYPE?	1644
[:SENSe]:SWEep:TYPE:AUTO OFF ON 0 1	1645
[:SENSe]:SWEep:TYPE:AUTO?	1645
[:SENSe]:SWEep:TYPE:AUTO:RULEs SPEed DRANge	1646
[:SENSe]:SWEep:TYPE:AUTO:RULEs?	1646
[:SENSe]:SWEep:TYPE:AUTO:RULEs:AUTO[:STATe] OFF ON 0 1	1647
[:SENSe]:SWEep:TYPE:AUTO:RULEs:AUTO[:STATe]?	1647
[:SENSe]:VECTor ADEMod:FREQuency:CENTer:TRACk OFF ON 0 1	1819
[:SENSe]:VECTor ADEMod:FREQuency:CENTer:TRACk?	1819
[:SENSe]:VOLTage POWER:IQ:MIRRored OFF ON 0 1	1237
[:SENSe]:VOLTage POWER:IQ:MIRRored?	1237
[:SENSe]:VOLTage:IQ[:I]:RANGe[:UPPer] <voltage>	1236
[:SENSe]:VOLTage:IQ[:I]:RANGe[:UPPer]?	1236
[:SENSe]:VOLTage:IQ:Q:RANGe[:UPPer] <voltage>	1238
[:SENSe]:VOLTage:IQ:Q:RANGe[:UPPer]?	1238
[:SENSe]:VOLTage:IQ:RANGe:AUTO OFF ON 0 1	1235
[:SENSe]:VOLTage:IQ:RANGe:AUTO?	1235
:SERVice[:PRODUCTION]:SIQuery:SCPI:LIST?	1634
:SOURce:AM[:DEPTH][:LINear]?	1582
:SOURce:AM[:DEPTH][:LINear]	1582
:SOURce:AM:INTernal:FREQuency?	1583
:SOURce:AM:INTernal:FREQuency	1583
:SOURce:AM:STATe?	1582
:SOURce:AM:STATe	1582
:SOURce:FM[:DEVIation]?	1584
:SOURce:FM[:DEVIation]	1584

List of Commands

:SOURce:FM:INTernal:FREQuency?	1584
:SOURce:FM:INTernal:FREQuency	1584
:SOURce:FM:STATe?	1583
:SOURce:FM:STATe	1583
:SOURce:FREQuency:CHANnels:BAND NONE PGSM EGSM RGSM DCS1800 PCS1900 TGSM810 GSM450 GSM480 GSM700 GSM850 BANDI BAND DII BANDIII BANDIV BANDV BANDVI BANDVII BANDVIII BANDIX BANDX BANDXI BANDXII BAND XIII BANDXIV USCELL USPCS JAPAN KOREAN NMT IMT2K UPPER SECOND PAMR400 PAMR800 IMT EXT PCS1DOT9G AWS US2DOT5G PUBLIC LOWER BAND1 BAND2 BAND3 BAND4 BAND5 BAND6 BA ND7 BAND8 BAND10 BAND11 BAND12 BAND13 BAND14 BAND17 BAND18 BAND19 BAND20 BAND21 BAND24 BAND25 BAND26 BAND33 BAND34 BAND35 BAND36 BAND37 BAND38 BAND39 BAND40 B AND41 BAND42 BAND43 BANDA BANDB BANDC BANDD BANDE BANDF.	1515
:SOURce:FREQuency:CHANnels:BAND?	1515
:SOURce:FREQuency:CHANnels:NUMBer <int>	1504
:SOURce:FREQuency:CHANnels:NUMBer?	1504
:SOURce:FREQuency[:CW] <freq>	1504
:SOURce:FREQuency[:CW]?	1504
:SOURce:FREQuency:OFFSet <freq>	1536
:SOURce:FREQuency:OFFSet?	1536
:SOURce:FREQuency:REFerence <freq>	1534
:SOURce:FREQuency:REFerence?	1534
:SOURce:FREQuency:REFerence:SET	1534
:SOURce:FREQuency:REFerence:STATe OFF ON 0 1	1534
:SOURce:FREQuency:REFerence:STATe?	1534
:SOURce:LIST:INITiation:ARMed?	1630
:SOURce:LIST:MPADapter:CORRection:ERRor?	1629
:SOURce:LIST:MPADapter:PORT:OUTPut:BITMap:MODE LIST FIXed	1629
:SOURce:LIST:MPADapter:PORT:OUTPut:BITMap:MODE?	1629
:SOURce:LIST:NUMBer:STEPs <integer>	1588
:SOURce:LIST:NUMBer:STEPs?	1588
:SOURce:LIST:SETup:AMPLitude <ampl>, <ampl>, <ampl>,	1625
:SOURce:LIST:SETup:AMPLitude?	1625
:SOURce:LIST:SETup:CLEar	1628
:SOURce:LIST:SETup:CNFRequency <double>, <double>, <double>,	1624

List of Commands

:SOURce:LIST:SETup:CNFRequency?	1624
:SOURce:LIST:SETup:DURation:TYPE <enum>, <enum>, <enum>,	1626
:SOURce:LIST:SETup:DURation:TYPE?	1626
:SOURce:LIST:SETup:INPut:TRIGger <enum>, <enum>, <enum>,	1622
:SOURce:LIST:SETup:INPut:TRIGger?	1622
:SOURce:LIST:SETup:OUTPut:TRIGger <bool>, <bool>, <bool>,	1628
:SOURce:LIST:SETup:OUTPut:TRIGger ?	1628
:SOURce:LIST:SETup:RADio:BAND <enum>, <enum>, <enum>,	1623
:SOURce:LIST:SETup:RADio:BAND?	1623
:SOURce:LIST:SETup:RADio:BAND:LINK <enum>, <enum>, <enum>,	1624
:SOURce:LIST:SETup:RADio:BAND:LINK?	1624
:SOURce:LIST:SETup:TOCount <time/int>, <time/int>, <time/int>,	1627
:SOURce:LIST:SETup:TOCount?	1627
:SOURce:LIST:SETup:TRANSition:TIME <time>, <time>, <time>,	1622
:SOURce:LIST:SETup:TRANSition:TIME?	1622
:SOURce:LIST:SETup:WAVEform <string>, <string>, <string>,	1626
:SOURce:LIST:SETup:WAVEform?	1626
:SOURce:LIST[:STATe] ON OFF 1 0	1587
:SOURce:LIST[:STATe]?	1587
:SOURce:LIST:STEP[1] 2 3 4..1000:SETup IMMEDIATE INTERNAL KEY BUS EXTERNAL2, <time>, NONE PGSM EGSM RGSM DCS1800 PCS1900 TGSM810 GSM450 GSM480 GSM700 GSM850 BANDI BANDII BANDIII BANDIV BANDV BANDVI BANDVII BANDVIII BANDIX BANDX BANDXI BANDXII BANDXIII BANDXIV USCELL USPCS JAPAN KOREAN NMT IMT2K UPPER SECOND PAMR400 PAMR800 IMT EXT PCS1DOT9G AWS US2DOT5G PUBLIC LOWER NONE BAND1 BAND2 BAND3 BAND4 BAND5 BAND6 BAND7 BAND8 BAND10 BAND11 BAND12 BAND13 BAND14 BAND17 BAND18 BAND19 BAND20 BAND21 BAND24 BAND25 BAND26 BAND33 BAND34 BAND35 BAND36 BAND37 BAND38 BAND39 BAND40 BAND41 BAND42 BAND43 BANDA BANDB BANDC BANDD BANDE BANDF, DOWN UP, <freq>, <ampl>, <string>, TIME COUNt CONTInuous, <time>, ON OFF 1 0, [<int>],	1620
:SOURce:LIST:STEP[1] 2 3 4..1000:SETup?	1620
:SOURce:LIST:STEP[1] 2 3...1000:SETup: RADio:BAND?	1593
:SOURce:LIST:STEP[1] 2 3...1000:SETup:AMPLitude <double>	1613
:SOURce:LIST:STEP[1] 2 3...1000:SETup:AMPLitude?	1613
:SOURce:LIST:STEP[1] 2 3...1000:SETup:CNFRequency <double>	1611
:SOURce:LIST:STEP[1] 2 3...1000:SETup:CNFRequency <double>	1612

List of Commands

:SOURce:LIST:STEP[1] 2 3...1000:SETup:CNFRequency?	1611
:SOURce:LIST:STEP[1] 2 3...1000:SETup:CNFRequency?	1612
:SOURce:LIST:STEP[1] 2 3...1000:SETup:DURation:TCOut <double>	1618
:SOURce:LIST:STEP[1] 2 3...1000:SETup:DURation:TCOut <double>	1619
:SOURce:LIST:STEP[1] 2 3...1000:SETup:DURation:TCOut?	1618
:SOURce:LIST:STEP[1] 2 3...1000:SETup:DURation:TCOut?	1619
:SOURce:LIST:STEP[1] 2 3...1000:SETup:DURation:TYPE TIME COUNt CONTInuous	1617
:SOURce:LIST:STEP[1] 2 3...1000:SETup:DURation:TYPE?	1617
:SOURce:LIST:STEP[1] 2 3...1000:SETup:INPut:TRIGger IMMEDIATE INTErnal EXTErnal2 KEY BUS	1590
:SOURce:LIST:STEP[1] 2 3...1000:SETup:INPut:TRIGger?	1590
:SOURce:LIST:STEP[1] 2 3...1000:SETup:OUTPut:TRIGger ON OFF 1 0	1619
:SOURce:LIST:STEP[1] 2 3...1000:SETup:OUTPut:TRIGger	1619
:SOURce:LIST:STEP[1] 2 3...1000:SETup:RADio:BAND NONE PGSM EGSM RGSM DCS1800 PCS1900 TGSM810 GSM450 GSM480 GSM700 GSM850 BANDI BAN DII BANDIII BANDIV BANDV BANDVI BANDVII BANDVIII BANDIX BANDX BANDXI BANDXII BAN DIII BANDXIV USCELL USPCS JAPAN KOREAN NMT IMT2K UPPER SECOND PAMR400 PAMR800 IMT EXT PCS1DOT9G AWS US2DOT5G PUBLIC LOWER NONE BAND1 BAND2 BAND3 BAND4 BAND5 BAN D6 BAND7 BAND8 BAND10 BAND11 BAND12 BAND13 BAND14 BAND17 BAND18 BAND19 BAND20 B AND21 BAND24 BAND25 BAND26 BAND33 BAND34 BAND35 BAND36 BAND37 BAND38 BAND39 BAN D40 BAND41 BAND42 BAND43 BANDA BANDB BANDC BANDD BANDE BANDF	1593
:SOURce:LIST:STEP[1] 2 3...1000:SETup:RADio:BAND:LINK DOWN UP	1611
:SOURce:LIST:STEP[1] 2 3...1000:SETup:RADio:BAND:LINK?	1611
:SOURce:LIST:STEP[1] 2 3...1000:SETup:TRANsition:TIME <time>	1592
:SOURce:LIST:STEP[1] 2 3...1000:SETup:TRANsition:TIME?	1592
:SOURce:LIST:STEP[1] 2 3...1000:SETup:WAVEform <string>	1614
:SOURce:LIST:STEP[1] 2 3...1000:SETup:WAVEform?	1614
:SOURce:LIST:TRIG	148
:SOURce:LIST:TRIGger[:IMMEDIATE]	1587
:SOURce:LIST:TRIGger:INITiate[:IMMEDIATE]	1588
:SOURce:PM[:DEVIation]?	1585
:SOURce:PM[:DEVIation]	1585
:SOURce:PM:INTErnal:FREQuency?	1585
:SOURce:PM:INTErnal:FREQuency	1585
:SOURce:PM:STATE?	1585

List of Commands

:SOURce:PM:STATe	1585
:SOURce:POWer:ALC[:STATe] ON OFF 1 0	1502
:SOURce:POWer:ALC[:STATe]?	1502
:SOURce:POWer[:LEVel][:IMMediate][:AMPLitude] <ampl>	1499
:SOURce:POWer[:LEVel][:IMMediate][:AMPLitude]?	1499
:SOURce:POWer[:LEVel][:IMMediate]:OFFSet <rel_ampl>	1502
:SOURce:POWer[:LEVel][:IMMediate]:OFFSet?	1502
:SOURce:POWer:REFerence <ampl>	1501
:SOURce:POWer:REFerence?	1501
:SOURce:POWer:REFerence:STATe OFF ON 0 1	1501
:SOURce:POWer:REFerence:STATe?	1501
:SOURce:PRESet	1630
:SOURce:RADio:ARB:DEFault:DIRectory?	1541
:SOURce:RADio:ARB:BASeband:FREQuency:OFFSet <freq>	1545
:SOURce:RADio:ARB:BASeband:FREQuency:OFFSet?	1545
:SOURce:RADio:ARB:CATalog?	1543
:SOURce:RADio:ARB:DEFault:DIRectory <string>	1541
:SOURce:RADio:ARB:DELeTe <string>	1541
:SOURce:RADio:ARB:DELeTe:ALL	1542
:SOURce:RADio:ARB:FCATalog?	1543
:SOURce:RADio:ARB:HEADer:CLEar	1579
:SOURce:RADio:ARB:HEADer:INFormation?	1581
:SOURce:RADio:ARB:HEADer:SAVE	1580
:SOURce:RADio:ARB:LOAD <string>	1539
:SOURce:RADio:ARB:LOAD:ALL <string>	1540
:SOURce:RADio:ARB:MDEStination:ALCHold NONE M1 M2 M3 M4	1578
:SOURce:RADio:ARB:MDEStination:ALCHold?	1578
:SOURce:RADio:ARB:MDEStination:PULSe NONE M1 M2 M3 M4	1576
:SOURce:RADio:ARB:MDEStination:PULSe?	1576
:SOURce:RADio:ARB:MPLicensed:NAME:LOCKed?	1573
:SOURce:RADio:ARB:MPLicensed:UID:LOCKed?	1573

List of Commands

:SOURce:RADio:ARB:MPOLarity:MARKer1 POSitive NEGative.	1574
:SOURce:RADio:ARB:MPOLarity:MARKer1?	1574
:SOURce:RADio:ARB:MPOLarity:MARKer2 POSitive NEGative.	1574
:SOURce:RADio:ARB:MPOLarity:MARKer2?	1574
:SOURce:RADio:ARB:MPOLarity:MARKer3 POSitive NEGative.	1575
:SOURce:RADio:ARB:MPOLarity:MARKer3?	1575
:SOURce:RADio:ARB:MPOLarity:MARKer4 POSitive NEGative.	1575
:SOURce:RADio:ARB:MPOLarity:MARKer4?	1575
:SOURce:RADio:ARB:RETRigger ON OFF IMMediate	1547
:SOURce:RADio:ARB:RETRigger?	1547
:SOURce:RADio:ARB:RSCaling <real>	1544
:SOURce:RADio:ARB:RSCaling?	1544
:SOURce:RADio:ARB:SCLock:RATE <freq>	1544
:SOURce:RADio:ARB:SCLock:RATE?	1544
:SOURce:RADio:ARB:SEQuence[:MWAVeform] <filename>, <waveform1>, <reps>, NONE M1 M2 M3 M4 M1M2 M1M3 M1M4 M2M3 M2M4 M3M4 M1M2M3 M1M2M4 M1M3M4 M2M3M4 M 1M2M3M4 ALL, {<waveform2>, <reps>, NONE M1 M2 M3 M4 M1M2 M1M3 M1M4 M2M3 M2M4 M3M4 M1M2M3 M1M2M4 M1M3M4 M2M3M4 M 1M2M3M4 ALL, }	1556
:SOURce:RADio:ARB:SEQuence[:MWAVeform]? <filename>	1556
:SOURce:RADio:ARB[:STATe] ON OFF 1 0	1536
:SOURce:RADio:ARB[:STATe]?	1536
:SOURce:RADio:ARB:TRIGger:INITiate	1582
:SOURce:RADio:ARB:TRIGger[:SOURce] KEY BUS EXTernal2	1549
:SOURce:RADio:ARB:TRIGger[:SOURce]?	1549
:SOURce:RADio:ARB:TRIGger:TYPE CONTInuous SINGle SADVance GATE	1546
:SOURce:RADio:ARB:TRIGger:TYPE?	1546
:SOURce:RADio:ARB:TRIGger:TYPE:CONTInuous[:TYPE] FREE TRIGger RESet.	1546
:SOURce:RADio:ARB:TRIGger:TYPE:CONTInuous[:TYPE]?	1546
:SOURce:RADio:ARB:TRIGger:TYPE:SADVance[:TYPE] SINGle CONTInuous	1549
:SOURce:RADio:ARB:TRIGger:TYPE:SADVance[:TYPE]?	1549
:SOURce:RADio:ARB:WAVEform <string>	1537

List of Commands

:SOURce:RADio:ARB:WAVEform?	1537
:SOURce:RADio:BAND:LINK DOWN UP	1533
:SOURce:RADio:BAND:LINK?	1533
:SOURce:RADio:MPADapter:CORRection:ERRor?	1586
:SOURce:SELf:TEST[:ALL]	1631
*SRE <integer>	189
*SRE?	189
*STB?	190
:SYSTem:APPLication:CATalog[:NAME]?	1459
:SYSTem:APPLication:CATalog[:NAME]:COUNt?	1459
:SYSTem:APPLication:CATalog:OPTion? <model>	1460
:SYSTem:APPLication:CATalog:REVision? <model>	1460
:SYSTem:APPLication[:CURRent][:NAME]?	1458
:SYSTem:APPLication[:CURRent]:OPTion?	1458
:SYSTem:APPLication[:CURRent]:REVision?	1458
:SYSTem:COMMunicate:GPIB[1][:SELf]:ADDRes <integer>	297
:SYSTem:COMMunicate:GPIB[1][:SELf]:ADDRes?	297
:SYSTem:COMMunicate:GPIB[1][:SELf]:CONTRoller[:ENABle] ON OFF 0 1	298
:SYSTem:COMMunicate:GPIB[1][:SELf]:CONTRoller[:ENABle]?	298
:SYSTem:COMMunicate:LAN:SCPI:HISLip:ENABle OFF ON 0 1	301
:SYSTem:COMMunicate:LAN:SCPI:HISLip:ENABle?	301
:SYSTem:COMMunicate:LAN:SCPI:SICL:ENABle OFF ON 0 1	301
:SYSTem:COMMunicate:LAN:SCPI:SICL:ENABle?	301
:SYSTem:COMMunicate:LAN:SCPI:SOCKet:CONTRol?	302
:SYSTem:COMMunicate:LAN:SCPI:SOCKet:ENABle OFF ON 0 1	300
:SYSTem:COMMunicate:LAN:SCPI:SOCKet:ENABle?	300
:SYSTem:COMMunicate:LAN:SCPI:TELNet:ENABle OFF ON 0 1	299
:SYSTem:COMMunicate:LAN:SCPI:TELNet:ENABle?	299
:SYSTem:COMMunicate:USB:CONNection?	304
:SYSTem:COMMunicate:USB:PACKets?	306
:SYSTem:COMMunicate:USB:STATus?	305

List of Commands

:SYSTem:CONFigure[:SYSTem]?	244
:SYSTem:CSYStem?	244
:SYSTem:DATE “<year>,<month>,<day>”	329
:SYSTem:DATE?	329
:SYSTem:DEFault [ALL] ALIGn INPut MISC MODEs PON	306
:SYSTem:ERRor[:NEXT]?	239
:SYSTem:ERRor:OVERload[:STATe] 0 1 OFF ON	242
:SYSTem:ERRor:VERBose OFF ON 0 1	241
:SYSTem:ERRor:VERBose?	241
:SYSTem:HELP:HEADers?	328
:SYSTem:HID?	314
:SYSTem:IDN <string>	303
:SYSTem:IDN?	303
:SYSTem:KLOCK OFF ON 0 1	328
:SYSTem:KLOCK?	328
:SYSTem:LIcense:EXTernal:LIST?	1632
:SYSTem:LIcense[:FPACK]:WAVEform:ADD <string>	1566
:SYSTem:LIcense[:FPACK]:WAVEform:CLEar <int>	1569
:SYSTem:LIcense[:FPACK]:WAVEform:FREE?	1571
:SYSTem:LIcense[:FPACK]:WAVEform:LOCK <int>	1570
:SYSTem:LIcense[:FPACK]:WAVEform:NAME? <int>	1572
:SYSTem:LIcense[:FPACK]:WAVEform:REPLace <int>, <string>	1568
:SYSTem:LIcense[:FPACK]:WAVEform:STATus? <int>	1570
:SYSTem:LIcense[:FPACK]:WAVEform:UID? <int>	1572
:SYSTem:LIcense[:FPACK]:WAVEform:USED?	1571
:SYSTem:LIcense:LIST:DETail?	1632
:SYSTem:LKEY <”OptionInfo”>, <”LicenseInfo”>	312
:SYSTem:LKEY? <”OptionInfo”>	313
:SYSTem:LKEY:DELeTe <”OptionInfo”>,<”LicenseInfo”>	312
:SYSTem:LKEY:LIST?	313
:SYSTem:LKEY:WAVEform:ADD <string>	1566

List of Commands

:SYSTem:LKEY:WAVeform:CLEar <int>	1569
:SYSTem:LKEY:WAVeform:FREE?	1571
:SYSTem:LKEY:WAVeform:LOCK <int>	1570
:SYSTem:LKEY:WAVeform:NAME? <int>	1572
:SYSTem:LKEY:WAVeform:REPLace <int>, <string>	1568
:SYSTem:LKEY:WAVeform:STATus? <int>	1570
:SYSTem:LKEY:WAVeform:UID? <int>	1572
:SYSTem:LKEY:WAVeform:USED?	1571
:SYSTem:MRELay:COUNT?	316
:SYSTem:OPTions?	327
:SYSTem:PDOWN [NORMal FORCe]	327
:SYSTem:PON:APPLication:LLISt <string of INSTrument:SElect names>	253
:SYSTem:PON:APPLication:LLISt?	253
:SYSTem:PON:APPLication:VMEMory[:AVailable]?	253
:SYSTem:PON:APPLication:VMEMory:TOTal?	253
:SYSTem:PON:APPLication:VMEMory:USED?	254
:SYSTem:PON:APPLication:VMEMory:USED:NAME? <INSTrument:SElect name>	254
:SYSTem:PON:ETIME?	317
:SYSTem:PON:MODE SA BASIC ADEMOD NFIGURE PNOISE CDMA2K TDSCD- MA VSA VSA89601 WCDMA WIMAXOFDMA	248
:SYSTem:PON:MODE?	248
:SYSTem:PON:TIME?	270
:SYSTem:PON:TYPE MODE USER LAST	246
:SYSTem:PON:TYPE?	246
:SYSTem:PRESet.	198
:SYSTem:PRESet:TYPE FACTory MODE USER	201
:SYSTem:PRESet:TYPE?	201
:SYSTem:PRESet:USER	331
:SYSTem:PRESet:USER:ALL	332
:SYSTem:PRESet:USER:SAVE	332
:SYSTem:PRINt:THEMe TDColor TDMonochrome FCOLor FMONochrome.	196

List of Commands

:SYSTem:PRINt:THEMe?	196
:SYSTem:PUP:PROcEss	251
:SYSTem:SHOW OFF ERRor SYSTem HARDware LXI HWSTatistics ALIGnment SOFTware CAPPLIcation.	238
:SYSTem:SHOW?	238
:SYSTem:TEMPerature:HEXTreme?	317
:SYSTem:TEMPerature:LEXTreme?	316
:SYSTem:TEST:WCTS:[ALL]	318
:SYSTem:TEST:WCTS:FEC	320
:SYSTem:TEST:WCTS:FEC:RESult?	324
:SYSTem:TEST:WCTS:MPADapter	319
:SYSTem:TEST:WCTS:MPADapter:RESult?	323
:SYSTem:TEST:WCTS:SHOW:RESult FEC	323
:SYSTem:TEST:WCTS:SHOW:RESult MPADapter	322
:SYSTem:TEST:WCTS:SHOW:RESult SOURce	320
:SYSTem:TEST:WCTS:SOURce	319
:SYSTem:TEST:WCTS:SOURce:RESult?	321
:SYSTem:TIME "<hour>,<minute>,<second>"	329
:SYSTem:TIME?	329
:SYSTem:VERSion?	328
:TRACe[1] 2 3 4 5 6:DISPlay[:STATe] ON OFF 0 1	1673
:TRACe[1] 2 3 4 5 6:DISPlay[:STATe]?	1673
:TRACe[1] 2 3 4 5 6:TYPE WRITe AVERAge MAXHold MINHold.	1665
:TRACe[1] 2 3 4 5 6:TYPE?	1665
:TRACe[1] 2 3 4 5 6:UPDate[:STATe] ON OFF 0 1	1673
:TRACe[1] 2 3 4 5 6:UPDate[:STATe]?	1673
:TRACe[1] 2 3:ACPower:DISPlay[:STATe] ON OFF 0 1	545
:TRACe[1] 2 3:ACPower:DISPlay[:STATe]?	545
:TRACe[1] 2 3:ACPower:TYPE WRITe AVERAge MAXHold MINHold	542
:TRACe[1] 2 3:ACPower:TYPE?	542
:TRACe[1] 2 3:ACPower:UPDate[:STATe] ON OFF 0 1	544
:TRACe[1] 2 3:ACPower:UPDate[:STATe]?	544

List of Commands

:TRACe:CHPower:TYPE WRITe AVERAge MAXHold MINHold	389
:TRACe:CHPower:TYPE?	389
:TRACe:CLear TRACE1 TRACE2 TRACE3 TRACE4 TRACE5 TRACE6	1686
:TRACe:CLear:ALL	1686
:TRACe:COpy TRACE1 TRACE2 TRACE3 TRACE4 TRACE5 TRACE6, TRACE1 TRACE2 TRACE3 TRACE4 TRACE5 TRACE6	1698
:TRACe:COpy?	1698
:TRACe[:DATA] TRACE1 TRACE2 TRACE3 TRACE4 TRACE5 TRACE6, <data>	1699
:TRACe[:DATA]? TRACE1 TRACE2 TRACE3 TRACE4 TRACE5 TRACE6	1700
:TRACe:DISPlay:VIEW:SPECTrogram:TIME?	1704
:TRACe:EXCHange TRACE1 TRACE2 TRACE3 TRACE4 TRACE5 TRACE6, TRACE1 TRACE2 TRACE3 TRACE4 TRACE5 TRACE6	1698
:TRACe:EXCHange?	1698
:TRACe:MATH:MEAN? TRACE1 TRACE2 TRACE3 TRACE4 TRACE5 TRACE6	1704
:TRACe:MATH:SMOoth TRACE1 TRACE2 TRACE3 TRACE4 TRACE5 TRACE6	1703
:TRACe:MATH:SMOoth:POINts <integer>	1703
:TRACe:MATH:SMOoth:POINts?	1703
:TRACe:OBWidth:TYPE WRITe AVERAge MAXHold MINHold	447
:TRACe:OBWidth:TYPE?	447
:TRACe:SEMAsk:TYPE WRITe AVERAge MAXHold MINHold	646
:TRACe:SEMAsk:TYPE?	646
*TRG	190
:TRIGger:<meas>[:SEquence]:SOURce IMMEDIATE VIDeo EXTernal1	1876
:TRIGger:<meas>[:SEquence]:SOURce?	1876
:TRIGger:<measurement>[:SEquence]:IQ:SOURce EXTernal1 EXTernal2 IMMEDIATE IQMag IDEMod QDE- Mod IINPut QINPut AIQMag	1709
:TRIGger:<measurement>[:SEquence]:IQ:SOURce?	1709
:TRIGger:<measurement>[:SEquence]:RF:SOURce EXTernal1 EXTernal2 IMMEDIATE LINE FRAME RF- Burst VIDeo IF ALARm LAN	1707
:TRIGger:<measurement>[:SEquence]:RF:SOURce?	1707
:TRIGger:<measurement>[:SEquence]:SOURce EXTernal1 EXTernal2 IMMEDIATE LINE FRAME RFBurst VID- eo IF ALARm LAN IQMag IDEMod QDEMod IINPut QINPut AIQMag	1704
:TRIGger:<measurement>[:SEquence]:SOURce?	1704

List of Commands

:TRIGger TRIGger1 TRIGger2[:SEQuence]:OUTPut HSWP MEASuring MAIN GATE GTRigger OEVEN SPOint SSWeep SSETtled S1Marker S2Marker S3Marker S4Marker OFF	1344
:TRIGger TRIGger1 TRIGger2[:SEQuence]:OUTPut?	1344
:TRIGger TRIGger1 TRIGger2[:SEQuence]:OUTPut:POLarity POSitive NEGative	1345
:TRIGger TRIGger1 TRIGger2[:SEQuence]:OUTPut:POLarity?	1345
:TRIGger:PVTime[:SEQuence]:SOURce IMMEDIATE VIDeo EXTernal[1] EXTernal2 RFBurst	734
:TRIGger:PVTime[:SEQuence]:SOURce?	734
:TRIGger[:SEQuence]:AIQMag:BANDwidth <freq>	1744
:TRIGger[:SEQuence]:AIQMag:BANDwidth?	1744
:TRIGger[:SEQuence]:AIQMag:CENTer <freq>	1744
:TRIGger[:SEQuence]:AIQMag:CENTer?	1744
:TRIGger[:SEQuence]:AIQMag:DELay <time>	1743
:TRIGger[:SEQuence]:AIQMag:DELay?	1743
:TRIGger[:SEQuence]:AIQMag:DELay:STATe OFF ON 0 1	1743
:TRIGger[:SEQuence]:AIQMag:DELay:STATe?	1743
:TRIGger[:SEQuence]:AIQMag:LEVel <ampl >	1743
:TRIGger[:SEQuence]:AIQMag:LEVel?	1743
:TRIGger[:SEQuence]:AIQMag:SLOPe POSitive NEGative	1743
:TRIGger[:SEQuence]:AIQMag:SLOPe?	1743
:TRIGger[:SEQuence]:ATRigger <time>	1746
:TRIGger[:SEQuence]:ATRigger?	1746
:TRIGger[:SEQuence]:ATRigger:STATe OFF ON 0 1	1746
:TRIGger[:SEQuence]:ATRigger:STATe?	1746
:TRIGger[:SEQuence]:EXTernal1:DELay <time>	1718
:TRIGger[:SEQuence]:EXTernal1:DELay <time>	1882
:TRIGger[:SEQuence]:EXTernal1:DELay?	1718
:TRIGger[:SEQuence]:EXTernal1:DELay?	1882
:TRIGger[:SEQuence]:EXTernal1:DELay:STATe OFF ON 0 1	1718
:TRIGger[:SEQuence]:EXTernal1:DELay:STATe OFF ON 0 1	1882
:TRIGger[:SEQuence]:EXTernal1:DELay:STATe?	1718
:TRIGger[:SEQuence]:EXTernal1:DELay:STATe?	1882

List of Commands

:TRIGger[:SEQuence]:EXTernal1:HOLDoff <time>	1882
:TRIGger[:SEQuence]:EXTernal1:HOLDoff?	1882
:TRIGger[:SEQuence]:EXTernal1:HOLDoff:STATe OFF ON 0 1	1882
:TRIGger[:SEQuence]:EXTernal1:HOLDoff:STATe?	1882
:TRIGger[:SEQuence]:EXTernal1:HOLDoff:TYPE BELow ABOVe	1883
:TRIGger[:SEQuence]:EXTernal1:HOLDoff:TYPE?	1883
:TRIGger[:SEQuence]:EXTernal1:LEVel <level>	1717
:TRIGger[:SEQuence]:EXTernal1:LEVel <voltage>	1881
:TRIGger[:SEQuence]:EXTernal1:LEVel?	1717
:TRIGger[:SEQuence]:EXTernal1:LEVel?	1881
:TRIGger[:SEQuence]:EXTernal1:SLOPe POSitive NEGative	1718
:TRIGger[:SEQuence]:EXTernal1:SLOPe POSitive NEGative	1881
:TRIGger[:SEQuence]:EXTernal1:SLOPe?	1718
:TRIGger[:SEQuence]:EXTernal1:SLOPe?	1881
:TRIGger[:SEQuence]:EXTernal2:DELay <time>	1721
:TRIGger[:SEQuence]:EXTernal2:DELay?	1721
:TRIGger[:SEQuence]:EXTernal2:DELay:STATe OFF ON 0 1	1721
:TRIGger[:SEQuence]:EXTernal2:DELay:STATe?	1721
:TRIGger[:SEQuence]:EXTernal2:LEVel	1720
:TRIGger[:SEQuence]:EXTernal2:LEVel?	1720
:TRIGger[:SEQuence]:EXTernal2:SLOPe POSitive NEGative	1720
:TRIGger[:SEQuence]:EXTernal2:SLOPe?	1720
:TRIGger[:SEQuence]:FRAMe:ADJust <time>	1729
:TRIGger[:SEQuence]:FRAMe:DELay <time>	1733
:TRIGger[:SEQuence]:FRAMe:DELay?	1733
:TRIGger[:SEQuence]:FRAMe:DELay:STATe OFF ON 0 1	1733
:TRIGger[:SEQuence]:FRAMe:DELay:STATe?	1733
:TRIGger[:SEQuence]:FRAMe:OFFSet <time>	1728
:TRIGger[:SEQuence]:FRAMe:OFFSet?	1728
:TRIGger[:SEQuence]:FRAMe:OFFSet:DISPlay:RESet	1730
:TRIGger[:SEQuence]:FRAMe:PERiod <time>	1727

List of Commands

:TRIGger[:SEQuence]:FRAMe:PERiod?	1727
:TRIGger[:SEQuence]:FRAMe:SYNC EXTernal1 EXTernal2 RFBurst OFF.	1731
:TRIGger[:SEQuence]:FRAMe:SYNC?	1731
:TRIGger[:SEQuence]:FRAMe:SYNC:HOLDoff <time>	1734
:TRIGger[:SEQuence]:FRAMe:SYNC:HOLDoff?	1734
:TRIGger[:SEQuence]:FRAMe:SYNC:HOLDoff:STATe OFF ON 0 1.	1734
:TRIGger[:SEQuence]:FRAMe:SYNC:HOLDoff:STATe?	1734
:TRIGger[:SEQuence]:HOLDoff <time>	1746
:TRIGger[:SEQuence]:HOLDoff?	1746
:TRIGger[:SEQuence]:HOLDoff:STATe OFF ON 0 1.	1746
:TRIGger[:SEQuence]:HOLDoff:STATe?	1746
:TRIGger[:SEQuence]:HOLDoff:TYPE NORMAl ABOVe BELow	1747
:TRIGger[:SEQuence]:HOLDoff:TYPE?	1747
:TRIGger[:SEQuence]:IDEMod:DELay <time>	1737
:TRIGger[:SEQuence]:IDEMod:DELay?	1737
:TRIGger[:SEQuence]:IDEMod:DELay:STATe OFF ON 0 1	1737
:TRIGger[:SEQuence]:IDEMod:DELay:STATe?	1737
:TRIGger[:SEQuence]:IDEMod:LEVel <voltage>	1736
:TRIGger[:SEQuence]:IDEMod:LEVel?	1736
:TRIGger[:SEQuence]:IDEMod:SLOPe POSitive NEGative	1737
:TRIGger[:SEQuence]:IDEMod:SLOPe?	1737
:TRIGger[:SEQuence]:IINPut:DELay <time>.	1740
:TRIGger[:SEQuence]:IINPut:DELay?	1740
:TRIGger[:SEQuence]:IINPut:DELay:STATe OFF ON 0 1.	1740
:TRIGger[:SEQuence]:IINPut:DELay:STATe?	1740
:TRIGger[:SEQuence]:IINPut:LEVel <voltage>	1740
:TRIGger[:SEQuence]:IINPut:LEVel?.	1740
:TRIGger[:SEQuence]:IINPut:SLOPe POSitive NEGative.	1740
:TRIGger[:SEQuence]:IINPut:SLOPe?	1740
:TRIGger[:SEQuence]:IQMag:DELay <time>	1736
:TRIGger[:SEQuence]:IQMag:DELay?.	1736

List of Commands

:TRIGger[:SEQuence]:IQMag:DELAy:STATe OFF ON 0 1	1736
:TRIGger[:SEQuence]:IQMag:DELAy:STATe?	1736
:TRIGger[:SEQuence]:IQMag:LEVel <ampl >	1735
:TRIGger[:SEQuence]:IQMag:LEVel?	1735
:TRIGger[:SEQuence]:IQMag:SLOPe POSitive NEGative	1735
:TRIGger[:SEQuence]:IQMag:SLOPe?	1735
:TRIGger[:SEQuence]:LINE:DELAy <time>	1716
:TRIGger[:SEQuence]:LINE:DELAy?	1716
:TRIGger[:SEQuence]:LINE:DELAy:STATe OFF ON 0 1	1716
:TRIGger[:SEQuence]:LINE:DELAy:STATe?	1716
:TRIGger[:SEQuence]:LINE:SLOPe POSitive NEGative	1716
:TRIGger[:SEQuence]:LINE:SLOPe?	1716
:TRIGger[:SEQuence]:QDEMod:DELAy <time>	1739
:TRIGger[:SEQuence]:QDEMod:DELAy?	1739
:TRIGger[:SEQuence]:QDEMod:DELAy:STATe OFF ON 0 1	1739
:TRIGger[:SEQuence]:QDEMod:DELAy:STATe?	1739
:TRIGger[:SEQuence]:QDEMod:LEVel <voltage>	1738
:TRIGger[:SEQuence]:QDEMod:LEVel?	1738
:TRIGger[:SEQuence]:QDEMod:SLOPe POSitive NEGative	1738
:TRIGger[:SEQuence]:QDEMod:SLOPe?	1738
:TRIGger[:SEQuence]:QINPut:DELAy <time>	1742
:TRIGger[:SEQuence]:QINPut:DELAy?	1742
:TRIGger[:SEQuence]:QINPut:DELAy:STATe OFF ON 0 1	1742
:TRIGger[:SEQuence]:QINPut:DELAy:STATe?	1742
:TRIGger[:SEQuence]:QINPut:LEVel <voltage>	1741
:TRIGger[:SEQuence]:QINPut:LEVel?	1741
:TRIGger[:SEQuence]:QINPut:SLOPe POSitive NEGative	1741
:TRIGger[:SEQuence]:QINPut:SLOPe?	1741
:TRIGger[:SEQuence]:RECOding:BASeband:DELAy <time>	1889
:TRIGger[:SEQuence]:RECOding:BASeband:DELAy?	1889
:TRIGger[:SEQuence]:RECOding:BASeband:DELAy:STATe OFF ON 0 1	1889

List of Commands

:TRIGger[:SEquence]:RECording:BASeband:DELAy:STATe?	1889
:TRIGger[:SEquence]:RECording:BASeband:HOLDoff <time>	1889
:TRIGger[:SEquence]:RECording:BASeband:HOLDoff?	1889
:TRIGger[:SEquence]:RECording:BASeband:HOLDoff:TYPE BELow ABOVe	1890
:TRIGger[:SEquence]:RECording:BASeband:HOLDoff:TYPE?	1890
:TRIGger[:SEquence]:RECording:BASeband:LEVel <voltage>	1888
:TRIGger[:SEquence]:RECording:BASeband:LEVel?	1888
:TRIGger[:SEquence]:RECording:BASeband:SLOPe POSitive NEGative	1888
:TRIGger[:SEquence]:RECording:BASeband:SLOPe?	1888
:TRIGger[:SEquence]:RECording:VIDeo:DELAy <time>	1885
:TRIGger[:SEquence]:RECording:VIDeo:DELAy?	1885
:TRIGger[:SEquence]:RECording:VIDeo:DELAy:STATe OFF ON 0 1	1885
:TRIGger[:SEquence]:RECording:VIDeo:DELAy:STATe?	1885
:TRIGger[:SEquence]:RECording:VIDeo:HOLDoff <time>	1886
:TRIGger[:SEquence]:RECording:VIDeo:HOLDoff?	1886
:TRIGger[:SEquence]:RECording:VIDeo:HOLDoff:STATe OFF ON 0 1	1886
:TRIGger[:SEquence]:RECording:VIDeo:HOLDoff:STATe?	1886
:TRIGger[:SEquence]:RECording:VIDeo:HOLDoff:TYPE BELow ABOVe	1887
:TRIGger[:SEquence]:RECording:VIDeo:HOLDoff:TYPE?	1887
:TRIGger[:SEquence]:RECording:VIDeo:LEVel <voltage>	1884
:TRIGger[:SEquence]:RECording:VIDeo:LEVel?	1884
:TRIGger[:SEquence]:RECording:VIDeo:SLOPe POSitive NEGative	1885
:TRIGger[:SEquence]:RECording:VIDeo:SLOPe?	1885
:TRIGger[:SEquence]:RFBurst:DELAy <time>	1725
:TRIGger[:SEquence]:RFBurst:DELAy?	1725
:TRIGger[:SEquence]:RFBurst:DELAy:STATe OFF ON 0 1	1725
:TRIGger[:SEquence]:RFBurst:DELAy:STATe?	1725
:TRIGger[:SEquence]:RFBurst:LEVel:ABSolute <ampl>	1722
:TRIGger[:SEquence]:RFBurst:LEVel:ABSolute?	1722
:TRIGger[:SEquence]:RFBurst:LEVel:RELative <rel_ampl>	1724
:TRIGger[:SEquence]:RFBurst:LEVel:RELative?	1724

List of Commands

:TRIGger[:SEQuence]:RFBurst:LEVel:TYPE ABSolute RELative	1723
:TRIGger[:SEQuence]:RFBurst:LEVel:TYPE?	1723
:TRIGger[:SEQuence]:RFBurst:SLOPe POSitive NEGative	1725
:TRIGger[:SEQuence]:RFBurst:SLOPe?	1725
:TRIGger[:SEQuence]:RLINe OFF ON 0 1	1875
:TRIGger[:SEQuence]:RLINe?	1875
:TRIGger[:SEQuence]:VIDeo:DELay <time>	1714
:TRIGger[:SEQuence]:VIDeo:DELay <time>	1878
:TRIGger[:SEQuence]:VIDeo:DELay?	1714
:TRIGger[:SEQuence]:VIDeo:DELay?	1878
:TRIGger[:SEQuence]:VIDeo:DELay:STATe OFF ON 0 1	1714
:TRIGger[:SEQuence]:VIDeo:DELay:STATe OFF ON 0 1	1878
:TRIGger[:SEQuence]:VIDeo:DELay:STATe?	1714
:TRIGger[:SEQuence]:VIDeo:DELay:STATe?	1878
:TRIGger[:SEQuence]:VIDeo:HOLDoff <time>	1879
:TRIGger[:SEQuence]:VIDeo:HOLDoff?	1879
:TRIGger[:SEQuence]:VIDeo:HOLDoff:STATe OFF ON 0 1	1879
:TRIGger[:SEQuence]:VIDeo:HOLDoff:STATe?	1879
:TRIGger[:SEQuence]:VIDeo:HOLDoff:TYPE BELow ABOVe	1880
:TRIGger[:SEQuence]:VIDeo:HOLDoff:TYPE?	1880
:TRIGger[:SEQuence]:VIDeo:LEVel <ampl>	1712
:TRIGger[:SEQuence]:VIDeo:LEVel <voltage>	1877
:TRIGger[:SEQuence]:VIDeo:LEVel?	1712
:TRIGger[:SEQuence]:VIDeo:LEVel?	1877
:TRIGger[:SEQuence]:VIDeo:SLOPe POSitive NEGative	1713
:TRIGger[:SEQuence]:VIDeo:SLOPe POSitive NEGative	1878
:TRIGger[:SEQuence]:VIDeo:SLOPe?	1713
:TRIGger[:SEQuence]:VIDeo:SLOPe?	1878
*TST?	191
:UNIT:ACPower:POWer:PSD DBMHZ DBMMHZ	519
:UNIT:ACPower:POWer:PSD?	519

List of Commands

:UNIT:CHPower:POWer:PSD DBMHZ DBMMHZ	369
:UNIT:CHPower:POWer:PSD?	369
:UNIT:POWer DBM DBMV DBMA V W A DBUV DBUA DBPW DBUVM DBUAM DBPT DBG	1245
:UNIT:POWer?	1245
*WAI	191

1 Using Help

The online Help system is "context-sensitive", which means that the information displayed when you invoke the Help system depends on the selected instrument Mode, Measurement and key.

NOTE The instructions for using help are applicable to the instrument front-panel as well as a virtual front panel.

TIP To view help for any front-panel key or menu key, press that key while this Help Window is open.

To scroll any page vertically, press the **Down Arrow** or **Up Arrow** front-panel keys. To locate these keys, see [“Front Panel Keys used by the Help System” on page 119](#).

NOTE **E6607C:** When using the E6607C there is no instrument front-panel. Therefore, the PC mouse and monitor are required for instrument control through a virtual front panel (VFP). For ease in using the VFP, the PC keyboard is recommended.

Structure of Help

See [“How Help is Organized” on page 116](#).

Navigating Help

- If the instrument has an attached mouse, see [“Navigating Help with a Mouse” on page 123](#).
- If the instrument does not have an attached mouse, see [“Navigating Help Without a Mouse” on page 124](#).

For specific details of how to navigate to topics, see [“Finding a Topic” on page 128](#).

- You can also copy the Help files to a separate computer and view them there. For details, see [“Viewing Help Files on a separate Computer” on page 131](#).

Locating Other Documentation

See [“Other Help Resources” on page 133](#).

Key Path	Front-panel key
Help Map ID	1001

How Help is Organized

This topic includes:

- “Help Contents Listing” on page 116
- “Key Descriptions for Each Measurement” on page 117
- “Key Information for Softkeys” on page 117
- “Common Measurement Functions” on page 118

Help Contents Listing

The listing under the Contents tab in the Help Window includes a topic for each Front-panel key and each softkey, for each available measurement.

The Contents listing is split into several major sections, as shown below for the HTML Help version of the document. The structure of the PDF version is similar.



Help information is split between these sections as follows:

1. Using Help

This section.

2. Additional Documentation

Describes available documents for the test set, with links to allow you to download or open the files.

3. About the Analyzer

Provides general information about the instrument.

4. About this Mode or Measurement Application

Provides an overview of the currently-selected Measurement Application

5. Programming the Test Set

Provides an overview of available programming information. Includes a list of all SCPI commands for the currently-selected Measurement Application.

6. System Functions

This section contains information for the following front-panel keys, which are listed in alphabetical order: **File, Preset, Print, Quick Save, Recall, Save, System, User Preset.**

The functions of these keys do not vary between measurements: they operate the same way, irrespective of which instrument measurement you have selected.

The sections for **Recall** and **Save** contain only cross-references to the respective sections in “[Common Measurement Functions](#)” on page 118, and are included here for convenience.

7. Measurement Functions

See “[Key Descriptions for Each Measurement](#)” on page 117 below.

8. Common Measurement Functions

See “[Common Measurement Functions](#)” on page 118 below.

[Back to Top](#)

Key Descriptions for Each Measurement

The Contents section for each Measurement is sub-divided into topics for each front-panel key, in alphabetical order, as shown below.

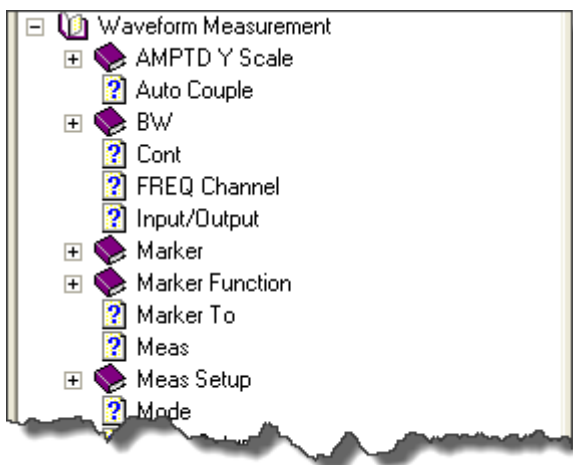

When you expand any front-panel key section, you will see a listing of softkeys in the menu for that front-panel key (if there is a menu), plus any SCPI Remote Commands associated with the functionality, as described in “[Key Information for Softkeys](#)” on page 117 below.

If you don't see a topic for a front-panel key in the Measurement-specific section, then it is located in the System Functions section.

[Back to Top](#)

Key Information for Softkeys

Information for each softkey that appears when you press a front-panel key (or a softkey with a submenu) is listed under the entry for each key.

Using Help
How Help is Organized

The example below shows the submenu under the **SPAN X Scale** Front-panel key in the "Waveform" Measurement, alongside the actual softkeys for that menu.

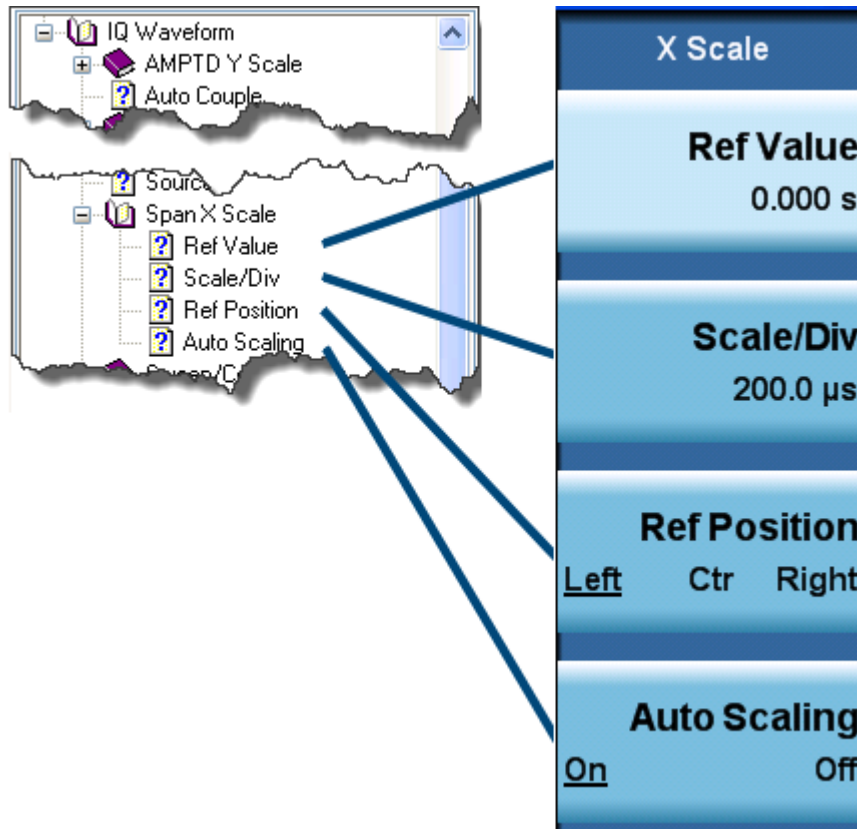

In these subsections, all softkeys are listed in the order they appear in their menu (that is, **not** in alphabetical order).

[Back to Top](#)

Common Measurement Functions

This section groups together function and key information that is shared between measurements. However, there is a listing for every front-panel key and subkey in the [Key Descriptions for Each Measurement](#), so you will generally not need to refer to this section.

The key subsections are listed alphabetically.

NOTE The presence of a key or command description in this section indicates that it is available in more than one measurement. Its presence does **not** indicate that the functionality is necessarily available in all measurements.

[Back to Top](#)

Front Panel Keys used by the Help System

The interactive Help system uses the front-panel keys shown below.

E6607A/B



E6607C

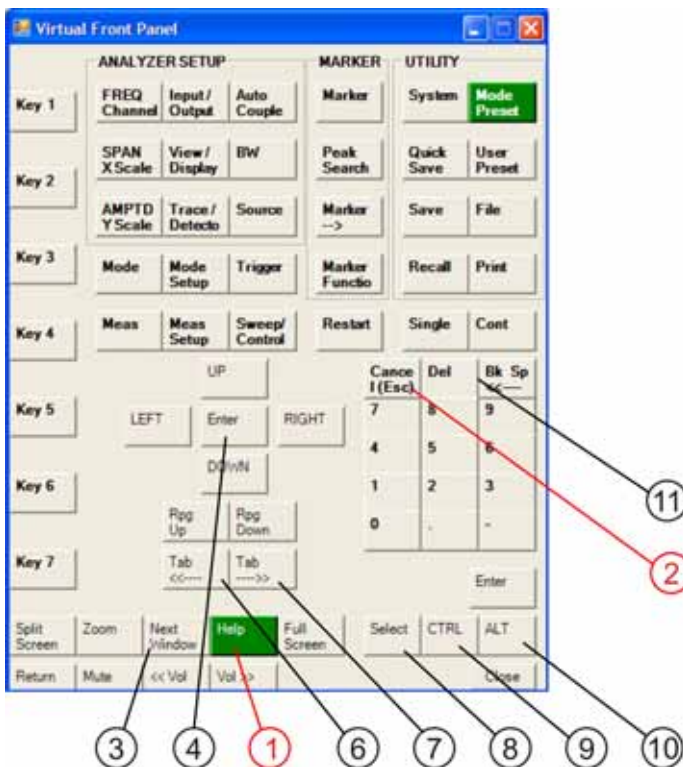

Using Help

Front Panel Keys used by the Help System

Item		Description
#	Name	
1	Help Key	Opens Help (displaying the topic for the last key pressed).
2	Cancel (Esc) Key	Exits Help.
3	Next Window Key	Changes the current window pane selection.
4	Arrow / Enter Keys	A central Enter key, surrounded by four directional arrow keys. Navigates within the Help system.
5	Knob	For future use.
6	Backward Tab Key	Moves between controls in the Help display.
7	Forward Tab Key	Moves between controls in the Help display.
8	Select / Space Key	Navigates within the Help system, in conjunction with other keys.
9	Ctrl Key	Navigates within the Help system, in conjunction with other keys. See “Navigating the Help Files” on page 121 .
10	Alt Key	Navigates within the Help system, in conjunction with other keys. See “Navigating the Help Files” on page 121 .
11	Bk Sp (Backspace) Key	Acts as a "Back" key when navigating the pages of the Help system.

[Back to Top](#)

Navigating the Help Files

This topic includes:

- “Help Window Components” on page 121
- “Basic Help Window Operations” on page 122
- “Navigating Help with a Mouse” on page 123

Help Window Components

The Help Window appears on top of, and to the left of, the measurement display. When Help is open, the instrument’s display appears as below.



1. Application Title Bar

The instrument retains its current Mode and Measurement when Help is open, as shown in the Title Bar.

2. Help Button Bar

These buttons provide shortcuts to frequently-used help functions, including printing.

3. Help Navigation Pane Tabs

Click one of these tabs to display either the Table of Contents, Index, Search, or Favorites controls.

4. Help Navigation Pane

5. Help Topic Pane

6. Previous Page and Next Page Buttons

Use these buttons to move to the previous or next page in the Help file.

7. Application Softkey Menu

You can still see and use the current softkey menu when Help is open.

When Help is open, pressing a softkey displays Help for that softkey, but does **not** execute the softkey’s function.

[Back to Top](#)

Basic Help Window Operations

This topic includes:

- “Opening Help” on page 122
- “Getting Help for a Specific Key” on page 122
- “Closing Help” on page 122
- “Viewing Help on Using Help” on page 123

For more Help window operations, see “Navigating Help Without a Mouse” on page 124.

To locate the keys mentioned in this section, see “Front Panel Keys used by the Help System” on page 119.

Opening Help

To access the Help system, press the green **Help** key below the front panel display while an Agilent application is running.



Note that the softkey menu remains visible when Help is open.

Getting Help for a Specific Key

- If Help **is** already open, press the desired key. The relevant Help topic appears.
The function normally invoked by the key is **not** executed when the key is pressed with Help open.
If you want to execute the key’s function, first close Help by pressing the **Cancel (Esc)** key (as described in “Closing Help” on page 122), then press the key, before opening Help again (if required).
- If Help is **not** already open, press the desired key (which executes the key’s function), then press the **Help** key to display the relevant Help page. Help is available for all softkeys, and for all the front-panel keys listed under the "System Functions" and "Measurement" sections.

For details of how to navigate within the panes of the Help window, see “Navigating the Help Files” on page 121.

[Back to Top](#)

Closing Help

To close Help, and return to the measurement application, press the **Cancel (Esc)** key (depicted below).



[Back to Top](#)

Viewing Help on Using Help

With the Help window open, press the green **Help** key a second time.

The "Using Help" page appears.

To exit Help on Using Help, press the **Bk Sp** key, or see [“Topic Pane Operations” on page 126](#) for equivalent methods.



[Back to Top](#)

Navigating Help with a Mouse

When Help is open, you can point-and-click to navigate, as you would when using Help for any Microsoft Windows computer application.

If you also have a keyboard attached to the instrument, you can use the Help system's full-text search feature to locate help for any topic, by typing in a key name, a topic name, or any other desired text. See [“Searching for a Help Topic” on page 124](#).

Selecting a Topic from the Contents Listing

To select and display a topic, do the following:

- If necessary, press the green **Help** key on the Front Panel, as described in [“Opening Help” on page 122](#), to open Help.
- Choose the desired topic from the list under the Contents Tab of the Navigation Pane, then click on the topic title to display the first page of the topic.
- To expand the tree and display a listing of subtopics (if any), click on the + icon to the left of the topic's book icon, as shown below.

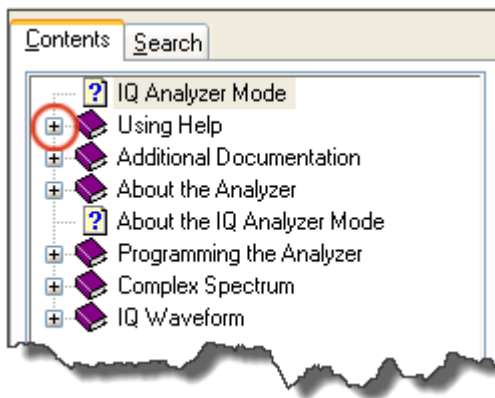

- To move to the next or previous page within a topic, click the **Next Page** or **Previous Page** keys (at the top right of the **Topic Pane**), as shown below.



[Back to Top](#)

Searching for a Help Topic

Select the "Search" tab of the Help Navigation Pane, then use the following procedure:

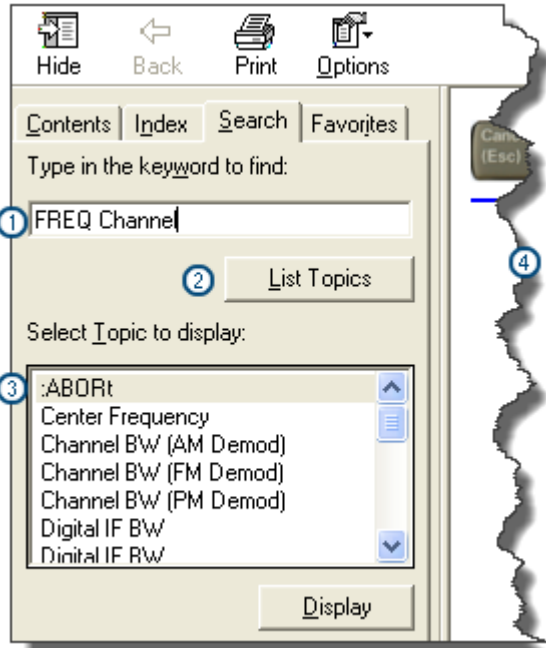

1. Type the desired topic text into the Search edit box. Note that the text search is **not** case-sensitive.
2. Click on the **List Topics** button.
3. **Either:**
Double-click on the desired topic in the list,
Or:
Click on the desired topic to select it, then click the **Display** button beneath the list.
4. The topic is displayed in the Topic Pane.

[Back to Top](#)

Navigating Help Without a Mouse

Most features of the Help system can be accessed and navigated without attaching a mouse or keyboard to the instrument.

There are a few exceptions, as noted in [“Functions that cannot be used without a Mouse and Keyboard” on page 128](#).

This topic includes:

- [“Next Window Key” on page 125](#)
- [“Contents Tab \(Navigation Pane\) Operations” on page 125](#)

- “Topic Pane Operations” on page 126
- “Selecting a Hyperlink” on page 127
- “Finding a Topic” on page 128

To locate all the keys mentioned in this section, see “Front Panel Keys used by the Help System” on page 119.

Next Window Key

- To toggle the focus between the Navigation Pane and the Topic Pane, press the **Next Window** key.



Contents Tab (Navigation Pane) Operations

- To switch the active tab, hold down the **Ctrl** key, then press either the **Forward Tab** or **Backward Tab** key.



- To scroll **horizontally**, hold down the **Ctrl** key, then press either the **Left Arrow** or **Right Arrow** keys.

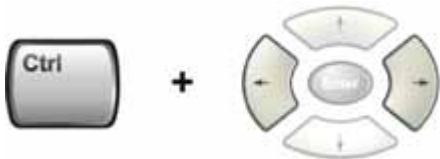

- To scroll **vertically**, hold down the **Ctrl** key, then press either the **Up Arrow** or **Down Arrow** keys.

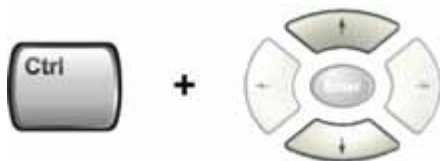

- To scroll up or down the list of topics, press the **Up Arrow** or **Down Arrow** keys.



Using Help

Navigating the Help Files

- To display a selected topic in the Topic Pane, select it in the Contents listing, then press the **Enter** key.



- To expand or collapse a selected topic, press the **Right Arrow** or **Left Arrow** key.

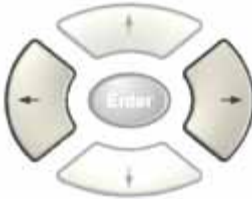

Back to Top

Topic Pane Operations

- To scroll up or down within a topic, press either the **Up Arrow** key or **Down Arrow** key.



- To go **back**
(that is, to display the previously-viewed topic), **either**:
Hold down the **Alt** key, then press the **Left Arrow** key.

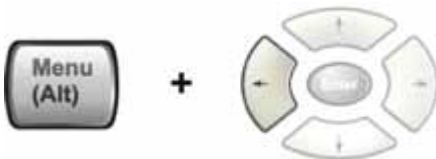

Or:

Press the **Bk Sp** key.



- To go **forward**, hold down the **Alt** key, then press the **Right Arrow** key.

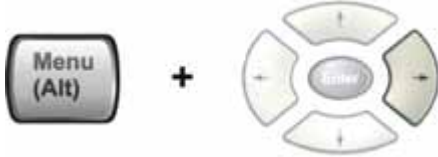

(The "Forward" operation has no effect unless there have been previous "Back" operations.)

- To go to the next or previous page, use the **Forward Tab** or **Backward Tab** keys



to select the **Next Page** or **Previous Page** key



then press **Enter**.



- To print the currently displayed, topic, press the Front-panel **Print** key



[Back to Top](#)

Selecting a Hyperlink

To select and follow a hyperlink on a Help page:.

1. Ensure that the focus is in the **Topic Pane**.
(If necessary, toggle the focus between the Navigation Pane and the Topic Pane by pressing the [Next Window Key](#).)
2. Move from link to link in the Topic Pane by pressing the **Forward Tab** and **Backward Tab** keys.



Links become highlighted upon selection.

Using Help

Navigating the Help Files

3. When you have selected the desired link, activate it by pressing the **Enter** key.



[Back to Top](#)

Finding a Topic

To display a different Help topic by selecting it from the Contents tab of the Navigation Pane:

1. Ensure that the focus is in the Contents tab of the Navigation Pane.
(If necessary, toggle the focus between the Navigation Pane and the Topic Pane, by pressing the [Next Window Key](#). Then press **Ctrl + Forward Tab** or **Backward Tab** to select the Contents tab.)
2. Move up or down the Contents list, by pressing the **Up Arrow** or **Down Arrow** keys.

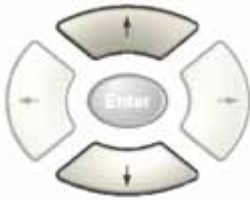

Topics become highlighted upon selection.

3. Display the selected topic, by pressing the **Enter** key.



[Back to Top](#)

Functions that cannot be used without a Mouse and Keyboard

The following parts of the HTML Help System **cannot** easily be used without attaching a mouse and keyboard to the instrument.

- The buttons in the Help Button Bar, consisting of: **Hide**, **Back**, **Print** and **Options**.
- The functionality of the Search Tab of the Navigation Pane.
- The functionality of the Favorites Tab of the Navigation Pane.

[Back to Top](#)

Definition of Terms

Many special terms are used throughout this documentation. The table below provides brief definitions of commonly-used terms. Please refer to the "Getting Started Guide" for detailed explanations.

Term	Meaning
Default Unit	The default measurement unit of the setting.
Default Terminator	Indicates the units that will be attached to the numeric value that you have entered. This default will be used from the front panel, when you terminate your entry by pressing the Enter key, rather than selecting a units key. This default will be used remotely when you send the command without specifying any units after your value(s).
Dependencies/ Couplings	Some commands may be unavailable when other parameters are set in certain ways. If applicable, any such limitations are described here.
Example	Provides command examples using the indicated remote command syntax.
Factory Preset	Describes the function settings after a Factory Preset .
Key Path	The sequence of Front-panel keys that accesses the function or setting.
Knob Increment/Decrement	The numeric value of the minimum increment or decrement that is applied when turning the thumb wheel knob.
Max	The Maximum numerical value that the setting can take.
Min	The Minimum numerical value that the setting can take.
Meas Global	The functionality described is the same in all measurements.
Meas Local	The functionality described is only true for the measurement selected.
Mode Global	The functionality described is the same for all modes.
Preset	In some cases, a Preset operation changes the status of a parameter. If the operation of the key specified is modified by a Preset operation, the effect is described here.
Range	Describes the range of the smallest to largest values to which the function can be set. If you try to set a value below the minimum value, the instrument defaults to the minimum value. If you try to set a value above the maximum value, the instrument defaults to the maximum value.
Remote Command	Shows the syntax requirements for each SCPI command.
Remote Command Notes	Additional notes regarding Remote Commands.
Resolution	Specifies the smallest change that can be made to the numeric value of a parameter.
SCPI Status Bits/ OPC Dependencies	Pressing certain keys may affect one or more status bits. If applicable, details are given here.

Term

Meaning

State Saved

Indicates what happens to a particular function when the instrument state is saved (either to an external memory device or the internal D: drive). It also indicates whether the current settings of the function are maintained if the instrument is powered on or preset using **Power On Last State** or **User Preset**.

[Back to Top](#)

Viewing Help Files on a separate Computer

You may want to view the help pages **without** having them appear on top of the instrument's screen.

Two separate Help files are available for each instrument Mode (or Measurement Application). The two files contain all the same help pages in different formats:

1. HTML Help (CHM) format.

These files are installed on the instrument's hard disk. To copy these files to another computer, see [“Copying the HTML Help \(CHM\) Files” on page 132](#) below.

2. Adobe Acrobat (PDF) format.

These files are called "Users & Programmers References". They are included on the Documentation CD supplied with the instrument, or may be downloaded from the Agilent web site.

For details of the names and locations of these files, see [“Additional Documentation” on page 121](#).

For details of how to navigate PDF files, see [“Navigating Acrobat \(PDF\) Files” on page 133](#).

You can copy any of the CHM or PDF files to another computer, then open and view the help pages in the file on that computer.

Your choice of which file to copy and view may depend on what you want to do with the file (for example, whether you want to print it and read the paper copy, or view it on the computer).

The table below compares the relative advantages of the two formats:

Format Type	HTML Help Format (CHM Files)	Acrobat Format (PDF Files)
File Extension	CHM	PDF
Software Required to view file	Microsoft Windows operating system only, with Microsoft Internet Explorer installed.	Free Adobe Reader software can be downloaded for many operating systems, including: Microsoft Windows, Macintosh, Linux, Solaris.
Full Text Search?	Yes	Yes
Printable?	Yes, but with limited control.	Yes. Full print control. See “Printing Acrobat Files” on page 134 .
Printable Table of Contents?	No	Yes
Navigable without a Mouse and Keyboard?	Yes, but with some loss of functionality.	No
Has Page Numbers?	No	Yes
Context-Sensitive Display?	Yes, when viewed using the X-Series Analyzer application window.	No
Indexed?	Yes	No

Active Hyperlinks? Yes

Yes

[Back to Top](#)

Copying the HTML Help (CHM) Files

You can find the HTML Help (.chm) files:

- **Either**, on the documentation CD that came with the instrument,
- **Or**, in a special directory on the instrument's hard disk. The directory path is:
C:\Program Files\Agilent\SignalAnalysis\Infrastructure\Help

NOTE You can open and view the HTML Help files only on a computer that has Microsoft Windows and Microsoft Internet Explorer installed.

[Back to Top](#)

Other Help Resources

- All available documentation is present either on the test set hard disk, either as HTML Help or Acrobat PDF files, or may be downloaded from the Agilent web site.
- To view a list of links to other documentation, see “Additional Documentation” on page 121, or click the item “Additional Documentation” in the Contents tab of the Help Navigation Pane.
- Many of the supporting documents use the Adobe Acrobat (PDF) file format. You can view PDF files using the pre-installed Adobe Reader software.

The Adobe Reader user interface differs from the Windows Help interface. For full details, see “Navigating Acrobat (PDF) Files” on page 133 and “Printing Acrobat Files” on page 134.

Navigating Acrobat (PDF) Files

IMPORTANT To navigate PDF files effectively, you must attach a mouse and keyboard to the instrument. If it is not possible to attach a mouse and keyboard to the instrument, you should transfer the PDF file to a separate computer, then open it on that computer.

Acrobat Reader Window

When a PDF file is open and being viewed, the instrument’s display shows the Adobe Acrobat Reader Window, which has the following features.

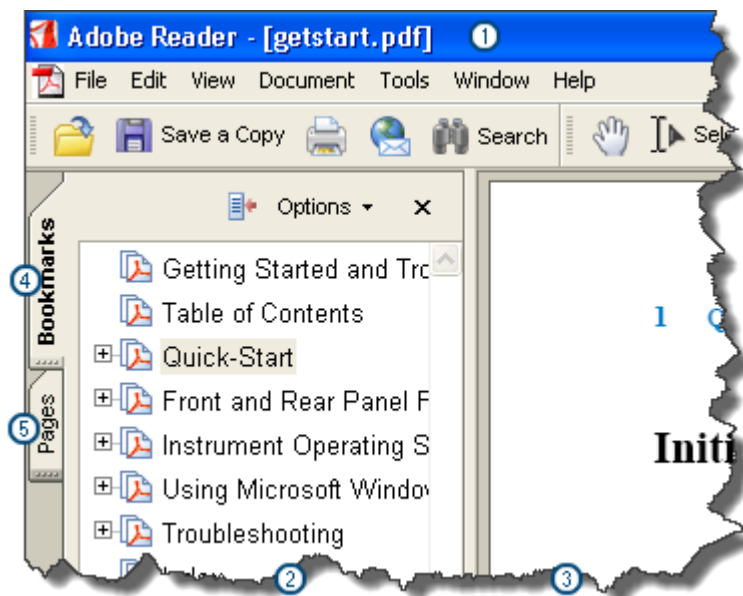

1. Adobe Acrobat Reader Window title bar
2. Navigation Pane
3. Document Pane

4. Navigation Pane: Bookmarks tab

5. Navigation Pane: Pages tab

The Navigation Pane also has tabs labeled Attachments and Comments, but, typically, PDF files for Agilent X-Series Analyzers contain useful content only under the Bookmarks and Pages Tabs.

Unlike the HTML Help Window, the Acrobat Reader Window is **not** embedded in the instrument's Application window, but can be resized, moved and closed independently of the Application window.

[Back to Top](#)

Printing Acrobat Files

NOTE The driver for the appropriate printer must be installed on the instrument's hard disk before any file can be printed. For driver installation instructions, see the printer manufacturer's documentation.

To print all or part of an open Acrobat file from the instrument, do the following.

1. **Either,**

a. click on the Print icon in the Acrobat Reader toolbar,



b. **or,** select File > Print from the menu.

2. The Acrobat Reader Print dialog opens.

3. Choose the desired options within the Print dialog, then click OK to print (or click Cancel to cancel printing).

NOTE Clicking the Properties button within the Print dialog opens a window containing controls that are specific to the printer model installed. Check the printer manufacturer's documentation for details of these capabilities.

[Back to Top](#)

Context Sensitive Help not Available

There is currently no context-sensitive help for the function you selected. However, this does not necessarily mean that no help is available for the function.

To find related information:

- If your instrument has an attached Mouse and Keyboard, see “Searching for a Help Topic” on page 124.
- If your instrument does **not** have an attached Mouse and Keyboard, see “Finding a Topic” on page 128.
- To learn how to select on-page links **without** a Mouse attached to your instrument, see “Selecting a Hyperlink” on page 127.

TIP To understand the organization of Help, see “How Help is Organized” on page 116.

Help Map ID	1002
-------------	------

Using Help
Context Sensitive Help not Available

2

About the Test Set

The EXT Wireless Communication Test Set is a one-box tester, combining a vector signal analyzer with a vector signal source in a single instrument. The analyzer and source are each provided with a dedicated list sequencer, for rapid execution of a series of stimulus or measurement steps. The test set is optimized for production testing (including calibration and verification) of wireless mobile devices.

E6607A/B



E6607C

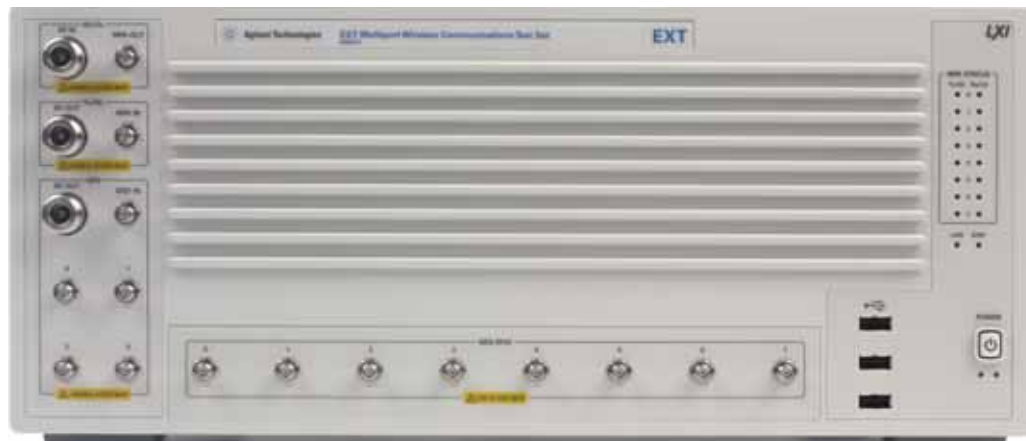

How the Test Set Is Used

The E6607A/B/C Wireless Communication Test Set is typically used in a production test environment where mobile devices are being calibrated and verified in a “non-signalling” mode (that is, in a mode of operation which does not involve call processing, and which relies instead on test functions which are built into the device under test).

The test controller communicates with both the DUT and the test set to coordinate Rx and Tx test operations and to collect test results. However, both the DUT and the test set perform their own independent operations during the process (for example, internal test routines run by the DUT, and sequences run by the test set).

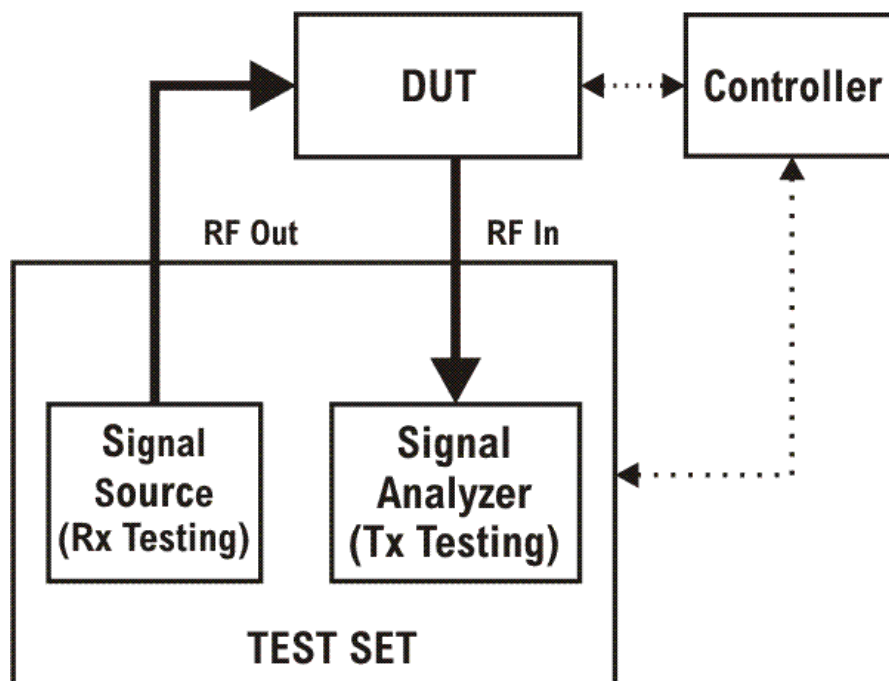

Receiver Testing

The source within the test set can supply test signals to the DUT for the purpose of receiver testing. Typically the source plays a waveform which has been downloaded to the test set (for example, a .wfm file generated using Agilent Signal Studio or some other application). In receiver testing, the test set is providing the necessary stimulus for measurements which are performed by the DUT itself, using its built-in self-test capabilities. The test results (bit error rate, for example) come back to the controller from the DUT rather than from the test set.

Transmitter Testing

The signal analyzer within the test set receives and measures signals from the DUT for the purpose of transmitter testing. Because the DUT is not being operated in a call-processing mode, the measurements

made by the analyzer pertain to signal quality (power, modulation accuracy, and so on) rather than to the data content of the transmitted signal. In transmitter testing, the measurement results come back to the controller from the test set rather than the DUT.

Hardware Elements of the Test Set

The test set includes a source and analyzer, which operate independently. You can control either of them directly (using front panel keys, the virtual front panel, or remote commands) or indirectly (by running a sequence, in which case the source and analyzer are operated by their list sequencers).

The source list sequencer and analyzer list sequencer function independently; however, you can coordinate their actions by setting them up to exchange trigger signals.

E6607A/B

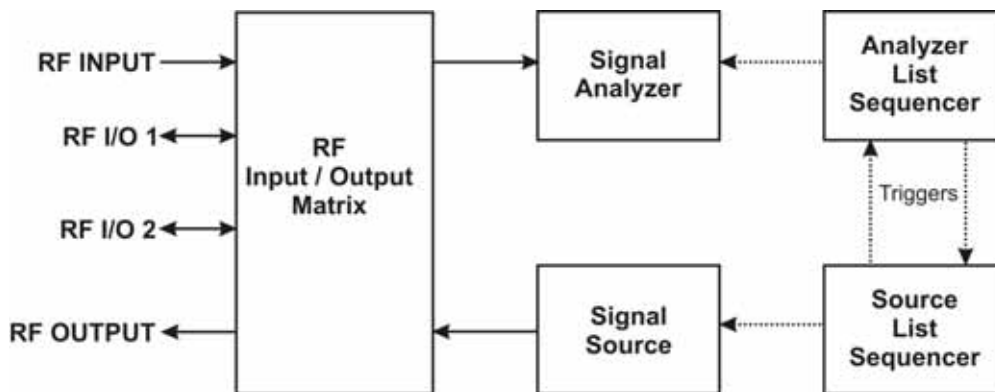

E6607C

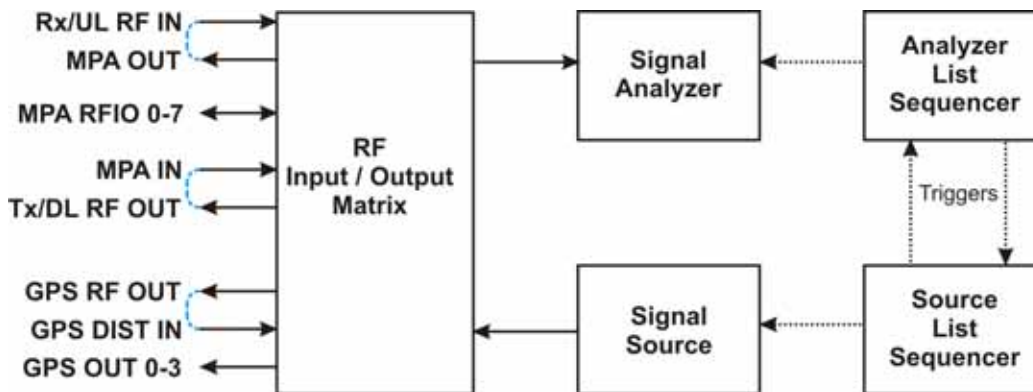

E6607A/B

The source and analyzer communicate with the device under test through an RF input/output matrix with four ports. Two of the ports have a fixed direction: an RF Output port which can be connected only to the source, and an RF Input port which can be connected only to the analyzer.

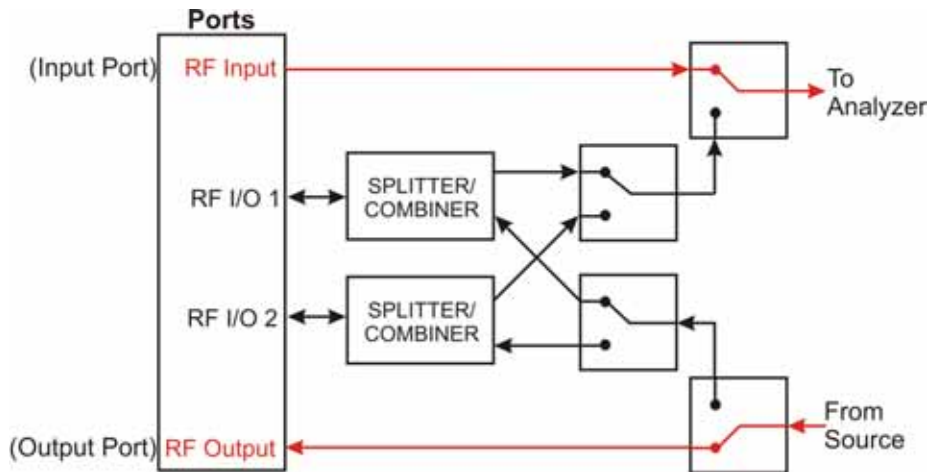

E6607C

The source and analyzer communicate with the device under test through an RF input/output matrix with multiple ports. Two of the ports have a fixed direction: an Tx/DL RF Out port which can be connected only to the source, and an Rx/UL RF In port which can be connected only to the analyzer.

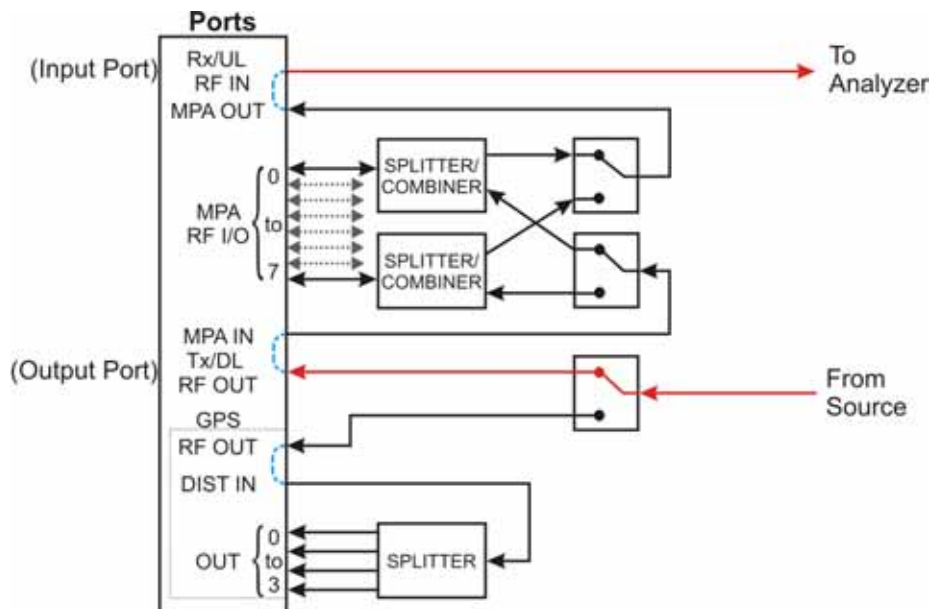

E6607A/B

The remaining two ports (the RF I/O ports) have bi-directional capability; they can be connected (through a splitter/combiner) to the source, to the analyzer, or to both at once. For example, in testing a mobile phone, both the source and the analyzer might be set up to interface with the device through the RF I/O 1 port, employing different frequencies for the transmit and receive signals.

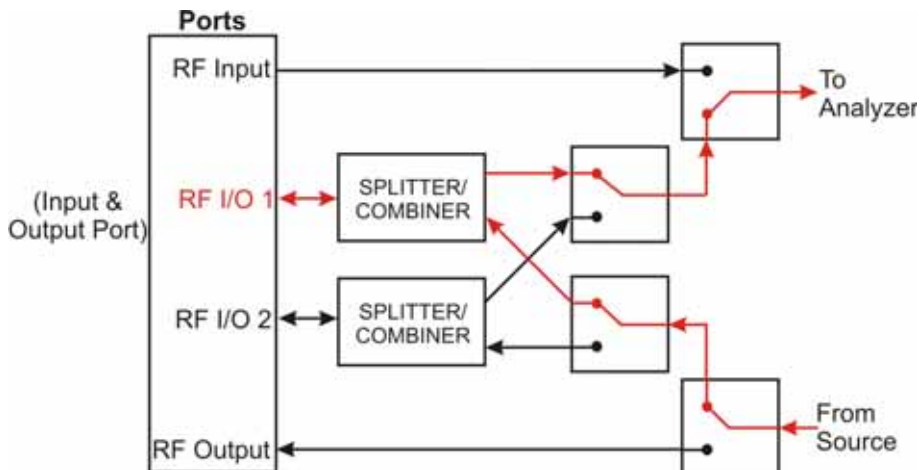

E6607C

The eight MPA RFIO ports have bi-directional capability; they can be connected (through internal splitter/combiners) to the source, to the analyzer, or to both at once. For example, in testing a mobile phone, both the source and the analyzer might be set up to interface with the device through the MPA RFIO 0 port, employing different frequencies for the transmit and receive signals.

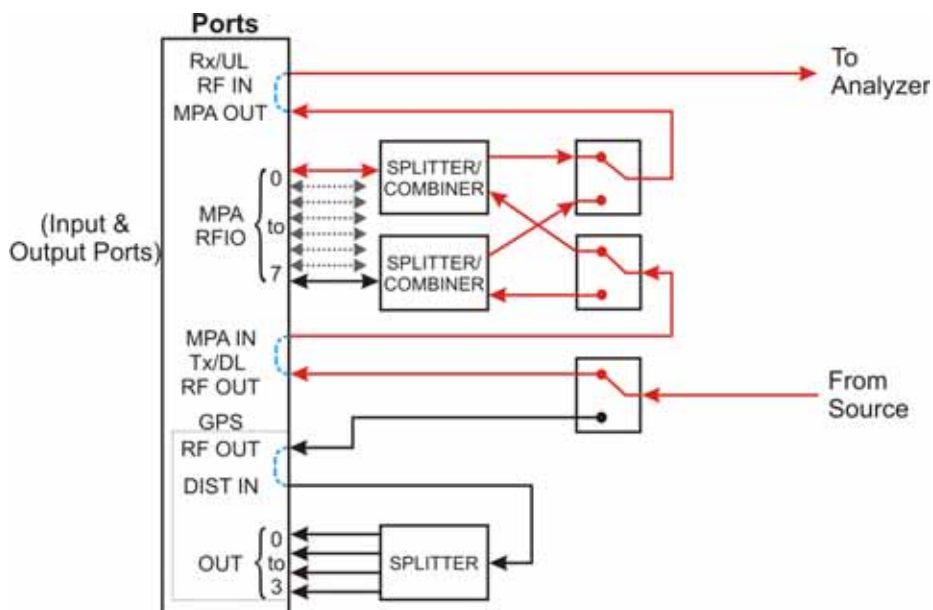

E6607A/B

The RF I/O ports can also be used in a single direction, as in the case illustrated below, where RF I/O 1 serves as the input port, and RF Output serves as the output port.

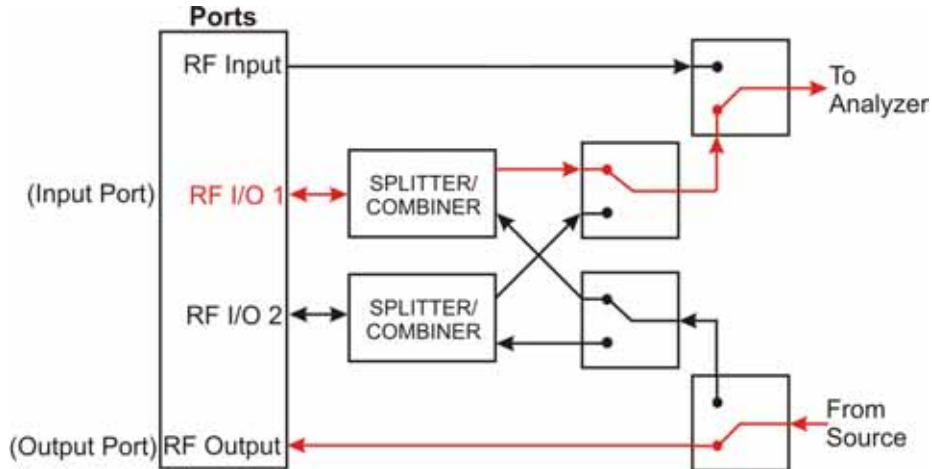

E6607C

The MPA RFIO ports can also be used in a single direction, as in the case illustrated below. In this case, the MPA RFIO 0-7 ports are paired and each pair is connected to a single DUT. In each pair, one serves as the input port and the other serves as the output port. This provides for a total of 4 DUTs connected to a single test set at the same time.

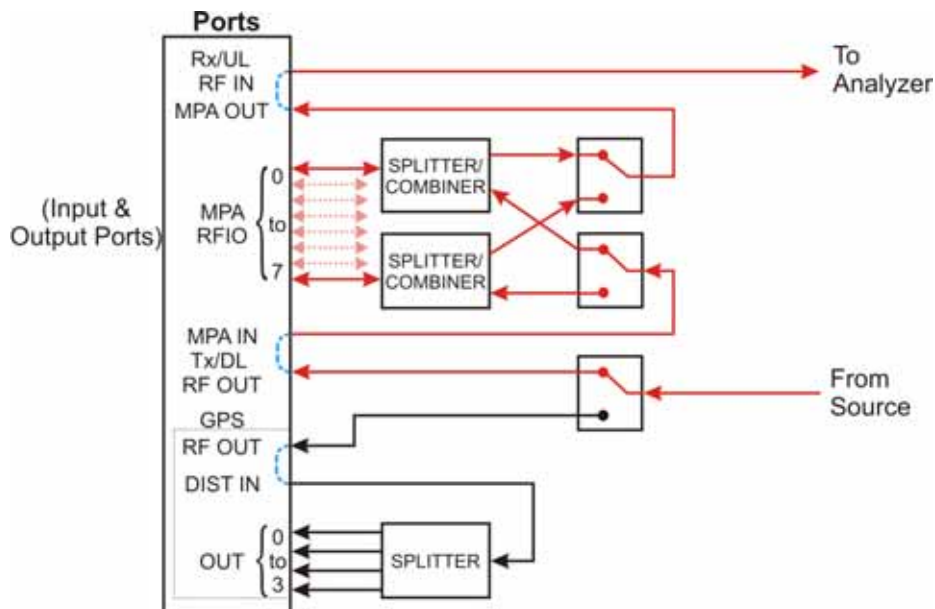

E6607C

When making GPS tests, the GPS OUT ports are fixed direction and are connected only to the source, as in the case illustrated below. In this case, four of the MPA RFIO 0-7 ports are paired with the four GPS OUT ports and each pair is connected to a single DUT. In each pair, the MPA RFIO port serves as the input port and the GPS OUT port serves as the output port. This provides for a total of 4 DUTs connected to a single test set at the same time.

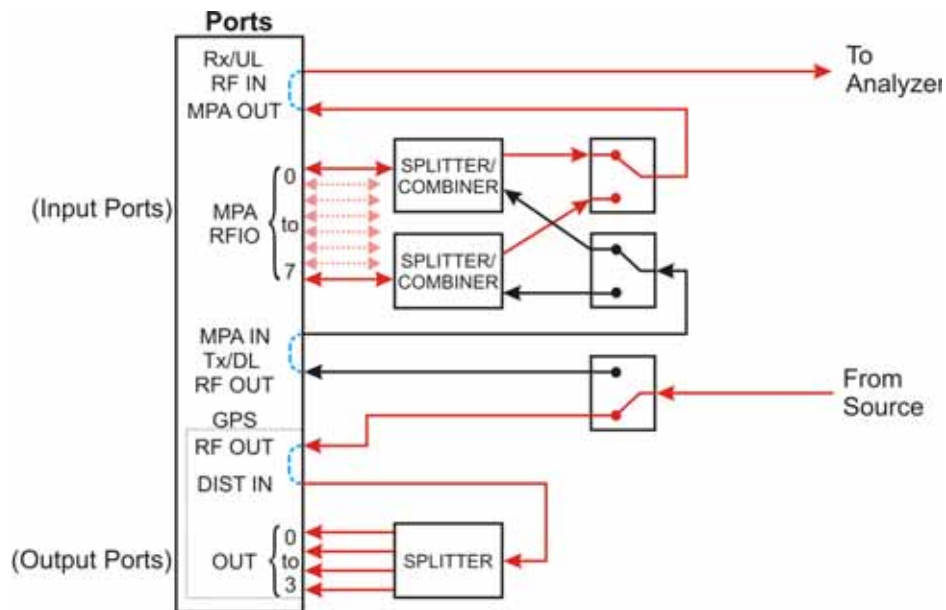

E6607A/B

For any sequence that the test set runs, a single port must be designated the input port, and a single port must be designated the output port. These port assignments cannot be changed during a sequence. The rules for port assignments are:

- Only one port at a time can be the input port, and it must be one of the following: RF Input, RF I/O 1, or RF I/O 2.
- Only one port at a time can be the output port, and it must be one of the following: RF Output, RF I/O 1, or RF I/O 2.
- RF I/O 1 can serve as both the input port and the output port simultaneously, but in that case it must be the only port in use.
- RF I/O 2 can serve as both the input port and the output port simultaneously, but in that case it must be the only port in use.

Although the two RF I/O ports cannot both be used bi-directionally at the same time, having two bi-directional ports offers practical advantages in reducing the impact of fixturing delays. For example, you can set up two sequences which are exactly alike, except that one of them designates RF I/O 1 as the input and output port, while the other sequence uses RF I/O 2 in the same way. During testing, the two sequences are run alternatively; a DUT is tested on one port while the next DUT is being fixtured on the other port.

E6607C

For any sequence that the test set runs using the MPA RFIO or GPS OUT ports, a single MPA RFIO port must be designated the input port. For the output signal to the DUT, any of the MPA RFIO ports can be designated as output ports. Up to eight of the MPA RFIO ports can provide an output signal at one time. (However, if the MPA RFIO ports are used in input/output pairs, this will limit the number of available output ports to four.) These port assignments cannot be changed during a sequence. The rules for port assignments are:

- Only one port at a time can be the input port, and it must be one of the following: Rx/UL RF IN or any one of MPA RFIO 0-7.
- MPA RFIO 0-7 serve as both input ports or output ports when the MPA RF OUT is connected to the MPA IN.
- GPS 0-3 serve as output ports simultaneously when the GPS OUT is connected to the Dist .

Software Elements of the Test Set

The test set firmware, which runs within the Windows XP Pro operating system, controls the source and analyzer, and provides access to a variety of licensed measurement applications which are available to be installed on the test set.

The basic test set includes licenses for two applications: the IQ Analyzer Mode (U9060A) and the Sequence Analyzer Mode (U9065A). Several other applications are available for installation. Many of the measurements which are included in these applications can be run from within the Sequence Analyzer mode, and not just in the native mode of the measurement. The table below shows all the available applications, and the measurements they include. Measurements which can be run from within the Sequence Analyzer mode are marked “available to sequencer” in the table.

Table 2-1 Applications and Measurements in the Test Set

Application	Measurement
IQ Analyzer Mode (U9060A)	<ul style="list-style-type: none"> • IQ Waveform • Complex Spectrum
Analog Demodulation Mode (U9063A)	<ul style="list-style-type: none"> • Amplitude Modulation • Frequency Modulation • Phase Modulation
Sequence Analyzer Mode (U9065A)	<ul style="list-style-type: none"> • Basic measurements: Power, Phase & Frequency, Discrete PAVT, IQ Data • List Sequencer • All application-specific measurements listed below that are marked “available to sequencer”.

Table 2-1 Applications and Measurements in the Test Set

Application	Measurement
GSM/EDGE Mode (U9071A)	<ul style="list-style-type: none"> • Transmit Power, also known as Burst Power • Power Vs. Time, GSM & Edge versions (available to sequencer) • GMSK Phase & Frequency (available to sequencer) • Output RF Spectrum, GMSK & EDGE versions (available to sequencer) • EDGE Error Vector Magnitude (available to sequencer)
cdma2000 Mode (U9072A)	<ul style="list-style-type: none"> • Channel Power • Code Domain • ACP (available to sequencer) • Spectrum Emission Mask (available to sequencer) • Occupied Bandwidth (available to sequencer) • Modulation Accuracy (available to sequencer) • QPSK Error Vector Magnitude (available to sequencer)
W-CDMA/HSPA Mode (U9073A)	<ul style="list-style-type: none"> • Channel Power • Adjacent Channel Power (available to sequencer) • Spectrum Emission Mask (available to sequencer) • Occupied Bandwidth (available to sequencer) • Code Domain (available to sequencer) • Modulation Accuracy (available to sequencer) • QPSK Error Vector Magnitude (available to sequencer) • Power Control (available to sequencer)
“WiMAX” Mode (802.16 OFDMA, U9075A)	<ul style="list-style-type: none"> • Channel Power • Adjacent Channel Power • Spectrum Emission Mask • Modulation Analysis
1xEVDO Mode (U9076A)	<ul style="list-style-type: none"> • Channel Power • Reverse-Link Code Domain • Adjacent Channel Power (available to sequencer) • Spectrum Emission Mask (available to sequencer) • Occupied Bandwidth (available to sequencer) • Reverse-Link Modulation Accuracy (available to sequencer)

Table 2-1 Applications and Measurements in the Test Set

Application	Measurement
TD-SCDMA with HSPA/8PSK (U9079A)	<ul style="list-style-type: none"> • Burst Power (Transmit Power) • Power vs Time • ACP (available to sequencer) • Spectrum Emission Mask (available to sequencer) • Occupied Bandwidth (available to sequencer) • Code Domain Power (available to sequencer) • Conformance Error Vector Magnitude (available to sequencer)
LTE Mode (U9080A)	<ul style="list-style-type: none"> • Channel Power • Modulation Analysis (available to sequencer) • Occupied Bandwidth (available to sequencer) • ACP (available to sequencer) • Spectrum Emission Mask (available to sequencer) • Conformance Error Vector Magnitude (available to sequencer)
Bluetooth (U9081A)	<ul style="list-style-type: none"> • ACP • LE In-band Emissions • EDR In-band Spurious Emissions • Occupied Bandwidth • Transmit Analysis
LTE TDD Mode (U9082A)	<ul style="list-style-type: none"> • Channel Power • Occupied Bandwidth (available to sequencer) • ACP (available to sequencer) • Spectrum Emission Mask (available to sequencer) • Transmit On/Off Power (available to sequencer) • LTE Modulation Analysis (available to sequencer) • Conformance Error Vector Magnitude (available to sequencer)

NOTE Some measurements which are not marked “available to sequencer” can be replaced by a basic measurement function which is available in the Sequence Analyzer mode. For example, it is possible to use the basic Power measurement in Sequence Analyzer mode as a substitute for a Channel Power measurement from one of the other modes. Some measurements are not currently supported by the analyzer list sequencer, and therefore can be run only in the native mode of the measurement.

Methods of Operating the Source

Regardless of which measurement mode is currently selected, the source can be operated using front panel keys, the virtual front panel, or remote commands, or by initiating the source list sequencer (which executes a predefined series of signal-generation steps).

The RF output of the source can be modulated by its internal arbitrary waveform generator, which runs waveform segment files that have been downloaded to the test set and loaded into ARB memory. (If a source sequence refers to a number of different waveform segments, all of these segments need to be loaded into ARB memory before the sequence can execute.)

In addition to playing back waveform segments in ARB memory, the source provides basic modulation functions (AM, FM, and PM).

Waveform Segment Files

A waveform segment can be defined in a set of binary files (an I/Q data file with its supporting header and marker files) or in a .wfm file (a combined file format which is produced by Agilent Signal Studio). Playback of .wfm segments requires installation of a Signal Studio license on the test set.

Where the segment is represented by separate binary files, the files need to be placed in the same directory, and need to follow a naming convention which enables the test set to recognize them: if the I/Q data file is called "testWaveform.bin", then the header file needs to be called "testWaveform_hdr.bin" and the marker file needs to be called "testWaveform_mkr.bin". The I/Q data file is the one that is loaded to ARB memory and is referenced by name in source sequences.

Methods of Operating the Analyzer

When a measurement mode other than Sequence Analyzer mode is selected, the analyzer can be operated using front panel keys, the virtual front panel, or remote commands. When the analyzer is used in this way, measurements are made in their native measurement mode (for example, GSM measurements in GSM/EDGE mode).

In Sequence Analyzer mode, initiating the analyzer list sequencer causes it to execute a predefined series of acquisitions and measurements. As described in [“Software Elements of the Test Set” on page 144](#) Sequence Analyzer mode incorporates many measurements from other modes; that is, measurements such as EDGE EVM in GSM/EDGE mode can also be included in a sequence, so that the measurements are made when the analyzer list sequencer is initiated. The Sequence Analyzer mode also includes four basic measurements (power, frequency, phase, and I/Q data).

Creating Sequences

A sequence is a set of parameters which defines a series of signals to be generated, or acquisitions to be analyzed, or both. The parameters can be saved to a text file and later recalled. Initiating the sequencers causes the source and/or analyzer to execute all steps defined in the sequence. (A series of SCPI commands can also be used for the same purpose.)

Although it is possible to create and save a simple sequence using front panel keys, the complexity of the format makes it preferable to use a spreadsheet template or other tool to create a sequence (which is saved to a text file).

The easiest method is to use Agilent Sequence Studio, a PC application designed specifically to generate

sequences for the EXT Wireless Communication Test Set. Sequence Studio is able to load waveform traces directly from the test set, so that the analysis intervals in the sequence can be aligned with the waveform, using an interactive graph display; this method of creating sequences is much more efficient than typing in numerical values.

Executing Sequences

Sequences are executed by initiating the source list sequencer, the analyzer list sequencer, or both.

The source list sequencer can be initiated (in any measurement mode) by using the **[Source], List Sequencer, Initiate Sequence** key, or by sending the `:SOURCE:LIST:TRIG` command.

The analyzer list sequencer can be initiated (in the Sequence Analyzer mode) by using the **[Restart]** key, or by sending the `:INIT` command.

When both list sequencers are used together, initiation of the sequencers must be carefully coordinated. It is not possible for both sequencers to be initiated absolutely simultaneously. When both are used, the source list sequencer should always be initiated first. There are two ways to coordinate the sequencers so that they are initiated in the proper order:

- Enable **Meas Setup, Include Source in Sequence**. When this selection is made, both of the list sequencers are initiated automatically, in the correct order, when you use a command or key to initiate the analyzer sequence (in this case, the source sequence cannot be initiated independently of the analyzer sequence).
- If “Include Source in Sequence” is disabled, then the source and analyzer must be initiated independently, and the source must be initiated first.

In addition to the initiating the sequencers, it is also necessary to trigger them. Output and input triggering for the two sequencers (as defined in the sequences they are executing) must be set up to coordinate the timing of their operations. Typically, the analyzer list sequencer generates a trigger input to the source list sequencer, so that the source begins generating a signal once the analyzer is ready to receive and analyze it.

Installing Application Software

When you want to install a measurement application after your initial hardware purchase, you only need to license it. All of the available applications are loaded in your test set at the time of purchase.

When you purchase an application, you receive an entitlement certificate that is used to obtain a license key for that particular measurement application. Enter the license key that you obtain into the EXT test set to activate the new measurement application.

For the latest information on Agilent X-series measurement applications and upgrade kits, visit the following internet URL: <http://www.agilent.com/find/ext>

Viewing a license key

Measurement personalities purchased with your test set have been installed and activated at the factory before shipment. The test set requires a unique **License Key** for every measurement application purchased. The license key is a hexadecimal string that is specific to your measurement application, test set model number and serial number. It enables you to install, or reactivate that particular application.

Press **System, Show, System** to display which measurement applications are currently licensed in your test set.

Go to the following location to view the license keys for the installed measurement applications:

C:\Programing Files\Agilent\Licensing

NOTE You may want to keep a copy of your license key in a secure location. You can print out a copy of the display showing the license numbers to do this. If you should lose your license key, call your nearest Agilent Technologies service or sales office for assistance.

Obtaining and installing a license key

If you purchase an additional application that requires installation, you will receive an “Entitlement Certificate” which may be redeemed for a license key for one test set. Follow the instructions that accompany the certificate to obtain your license key.

Installing a license key for the selected application can be done using a USB memory device. To do this, you put the license file on the USB memory device at the root level. Follow the instructions that come with your software installation kit.

Installing a license key can also be done manually using the license management application in the test set. It is found through the test set front panel keys at **System, Licensing...**, or internally at C:\Programming Files\Agilent\Licensing.

NOTE You can also use these procedures to reinstall a license key that has been accidentally deleted, or lost due to a memory failure.

Missing and old Measurement application software

All the software applications were loaded at the time of original test set manufacture. It is a good idea to regularly update your software with the latest available version. This assures that you get any improvements and expanded functionality that is available.

Because the software was loaded at the initial purchase, there may be additional measurement applications that are now available. If the application you are interested in licensing is not available, you will need to do a software update. (Press **System, Show, System.**)

Check the Agilent internet website for the latest software versions available for downloading:

http://www.agilent.com/find/ext_software

You must load the updated software package into the test set from a USB drive, or directly from the internet. An automatic loading program is included with the files.

X-Series options and accessories

“EXT Test Set Options” on page 151

“EXT X-series accessories” on page 151

“Advanced Measurement Application Software” on page 151

EXT Test Set Options

Product	Description
<EXT model number>	Wireless communications test set
<EXT model number>-503	Frequency range from 10 MHz to 3.6 GHz
<EXT model number>-504	Frequency range from 10 MHz to 3.8 GHz
<EXT model number>-UK6	Commercial Calibration Certificate with Test Data

EXT X-series accessories

Product	Description
<EXT model number>-EFM	USB storage device 4 GB blank
<EXT model number>-KYB	Keyboard, USB interface
<EXT model number>-HTC	Hard transit case
<EXT model number>-ICP	Rackmount kit with handles
<EXT model number>-1CN	Front handle kit
<EXT model number>-1CM	Rackmount kit
<EXT model number>-1CR	Rack slide kit

Advanced Measurement Application Software

For a current list of application software, go to the following URLs.

<http://www.agilent.com/find/ext>

Select the **Options** tab on the top of the webpage.

Front-Panel Features (E6607A/B)



Item		Description
#	Name	
1	Menu Keys	Key labels appear to the left of the menu keys to identify the current function of each key. The displayed functions are dependent on the currently selected Mode and Measurement, and are directly related to the most recent key press.
2	Measurement Keys	These keys select the Mode, and the Measurement within the mode. They also control the initiation and rate of recurrence of measurements.
3	Setup Keys	These keys set the parameters used for setting up the test set in the current Mode.
4	Marker Keys	Markers are often available for a measurement, to measure a very specific point/segment of data within the range of the current measurement data.
5	Utility Keys	These keys control system-wide functionality such as <ul style="list-style-type: none"> • test set configuration information and I/O setup, • printer setup and printing, • file management, save and recall, • test set presets.
6	Probe Power	Supplies power for external high frequency probes and accessories.
7	Headphones Output	Headphones can be used to hear any available audio output.
8	Back Space Key	Press this key to delete the previous character when entering alphanumeric information. It also works as the Back key in Help and Explorer windows.
9	USB Connectors	Standard USB 2.0 ports, Type A. Connect to external peripherals such as a mouse, keyboard, DVD drive or hard drive.

Item		Description
#	Name	
10	Delete Key	Press this key to delete files, or to perform other deletion tasks.
11	Local/Cancel/(Esc) Key	<p>If you are in remote operation the Local key</p> <ul style="list-style-type: none"> returns test set control from remote back to local (the front panel). turns the display on (if it was turned off for remote operation). can be used to clear errors. (Press the key once to return to local control, and a second time to clear error message line.) <p>If you have not already pressed the units or Enter key, Cancel exits the currently selected function without changing its value.</p> <p>Esc works the same as it does on a pc keyboard. It</p> <ul style="list-style-type: none"> exits Windows dialogs clears errors aborts printing cancels operations. <p>This key also exits the help system if it has been accessed.</p>
12	Numeric Keypad	Enters a specific numeric value for the current function. Entries appear on the upper left of the display, in the measurement information area.
13	Enter and Arrow Keys	<p>The Enter key terminates data entry when either no unit of measure is needed, or you want to use the default unit.</p> <p>The arrow keys</p> <ul style="list-style-type: none"> Increment and decrement the value of the current measurement selection. Navigate help topics. Navigate, or make selections, within Windows dialogs. Navigate within forms used for setting up measurements. Navigate within tables. <p>NOTE The arrow keys cannot be used to move a mouse pointer around on the display.</p>
14	Menu/ (Alt) Key	Alt works the same as a pc keyboard. Use it to change control focus in Windows pull-down menus.
15	Ctrl Key	Ctrl works the same as a pc keyboard. Use it to navigate in Windows applications, or to select multiple items in lists.
16	Select / Space Key	Select is also the Space key and it has typical pc functionality. For example, in Windows dialogs, it selects files, checks and unchecks check boxes, and picks radio button choices. It opens a highlighted Help topic.
17	Tab Keys	Use these keys to move between fields in Windows dialogs.
18	Knob	Increments and decrements the value of the current active function.
19	Return Key	Exits the current menu and returns to the previous menu. Has typical pc functionality.
20	Full Screen Key	Pressing this key turns off the softkeys to maximize the graticule display area.

About the Test Set
Front-Panel Features (E6607A/B)

Item		Description
#	Name	
21	Help Key	Initiates a context-sensitive help display for the current Mode. Once Help is accessed, pressing a front panel key brings up the help topic for that key function. Use the Local/Cancel/(Esc) key to exit help.
22	Speaker Control Keys	Enables you to increase or decrease the speaker volume, or mute it.
23	Window Control Keys	These keys select between single or multiple window displays. They zoom the current window to fill the data display, or change the currently selected window. They can be used to switch between the Help window navigation pane and the topic pane.
24	Power Standby/ On	Turns the test set on. A green light indicates power on. A yellow light indicates standby mode. <div style="border: 1px solid black; padding: 2px; display: inline-block; margin: 5px 0;">NOTE</div> The front-panel switch is a standby switch, not a LINE switch (disconnecting device). The test set continues to draw power even when the line switch is in standby. The main power cord can be used as the system disconnecting device. It disconnects the mains circuits from the mains supply.
25	RF I/O 1 Connector	RF Input/Output port #1 (communicates with both the source and the analyzer).
26	RF I/O 2 Connector	RF Input/Output port #2 (communicates with both the source and the analyzer).
27	RF Output	The test set's RF output port (communicates only with the source).
28	RF Input	The test set's RF input port (communicates only with the analyzer).

Overview of key types

The keys labeled **FREQ Channel**, **System**, and **Marker Functions** are all examples of front-panel keys.



Most of the dark or light gray keys access menus of functions that are displayed along the right side of the display. These displayed key labels are next to a column of keys called menu keys.

Menu keys list functions based on which front-panel key was pressed last. These functions are also dependant on the current selection of measurement application (**Mode**) and measurement (**Meas**).

If the numeric value of a menu key function can be changed, it is called an active function. The function label of the active function is highlighted after that key has been selected. For example, press **AMPTD Y Scale**. This calls up the menu of related amplitude functions. The function labeled **Ref Level** (the default selected key in the Amplitude menu) is highlighted. **Ref Level** also appears in the upper left of the display in the measurement information area. The displayed value indicates that the function is selected and its

value can now be changed using any of the data entry controls.



Some menu keys have multiple choices on their label, such as **On/Off** or **Top/Ctr/Bot** (as shown below). The different choices are selected by pressing the key multiple times. For example, the Auto/Man type of key. To select the function, press the menu key and notice that Auto is underlined and the key becomes highlighted. To change the function to manual, press the key again so that Man is underlined. If there are more than two settings on the key, keep pressing it until the desired selection is underlined.

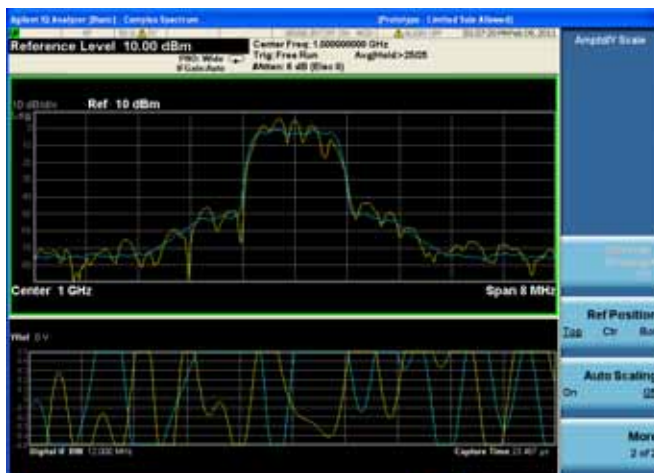

When a menu first appears, one key label is highlighted to show which key is the default selection. If you

About the Test Set Front-Panel Features (E6607A/B)

press **Marker Function**, the **Marker Function Off** key is the menu default key, and is highlighted.



Some of the menu keys are grouped together by a yellow bar running behind the keys near the left side or by a yellow border around the group of keys. When you press a key within the yellow region, such as **Marker Noise**, the highlight moves to that key to show it has been selected. The keys that are linked are related functions, and only one of them can be selected at any one time. For example, a marker can only have one marker function active on it. So if you select a different function it turns off the previous selection. If the current menu is two pages long, the yellow bar or border could include keys on the second page of keys.



In some key menus, a key label is highlighted to show which key has been selected from multiple available choices. And the menu is immediately exited when you press one of the other keys. For example, when you press the **Select Marker** key (in the **Marker** menu), it brings up its own menu of keys. The **Marker 1** key is highlighted. When you press the **marker 2** key, the highlight moves to that key and

the screen returns to the **Marker** menu.



If a displayed key label shows a small solid-black arrow tip pointing to the right, it indicates that additional key menus are available. If the arrow tip is not filled in solid then pressing the key the first time selects that function. Now the arrow is solid and pressing it again brings up an additional menu of

About the Test Set Front-Panel Features (E6607A/B)

settings.



Front-Panel Features (E6607C)

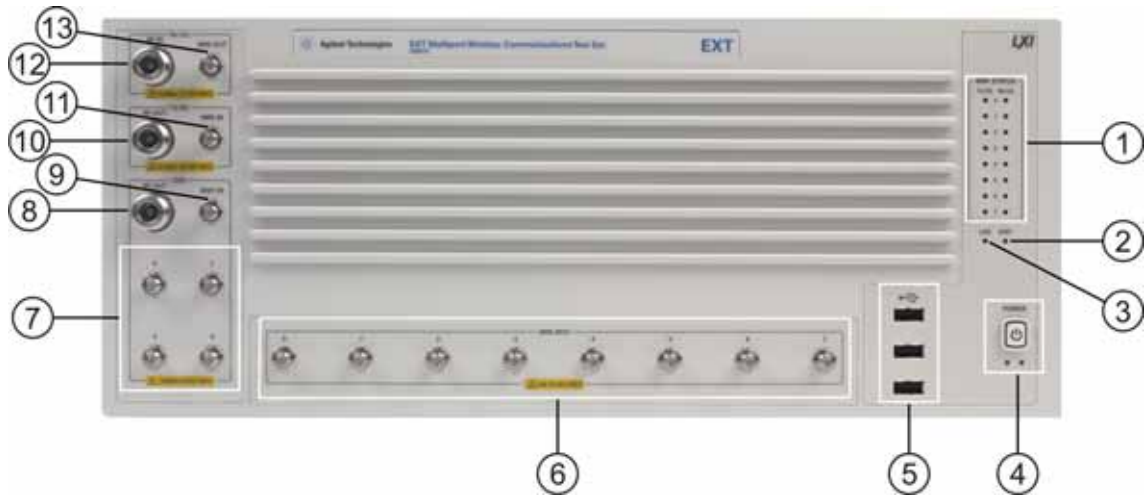

Item		Description
#	Name	
1	MPA Status	<p>MPA Status Indicator LEDs light indicating the status of the instrument:</p> <ul style="list-style-type: none"> Tx/DL 0 - 7 (these light to indicate that the related RFIO ports are being used to transmit RF outputs to the connected DUTs). Rx/UL 0 - 7 (these light to indicate that the related RFIO ports are being used to receive RF inputs from the connected DUTs). <p>NOTE There are no indicators for the GPS ports, because the ports cannot be switched on or off. Whatever RF input is provided to the GPS DIST IN port is always split and delivered to the GPS 0 - 3 ports.</p>
2	Stat	<p>SCPI Status Indicator LED lights to indicate that the instrument is ready to receive a remote SCPI command.</p>
3	LAN	<p>LAN Status Indicator LED lights to indicate that the instrument has made an active LAN connection.</p>
4	Power	<p>Power Standby/On switch and indicator LEDs. A green light indicates power on. A yellow light indicates standby mode.</p> <p>NOTE The front-panel switch is a standby switch, not a LINE switch (disconnecting device). The test set continues to draw power even when the line switch is in standby.</p> <p>The main power cord can be used as the system disconnecting device. It disconnects the mains circuits from the mains supply.</p>
5	USB Connectors	<p>Standard USB 2.0 ports, Type A. Connect to external peripherals such as a mouse, keyboard, DVD drive or hard drive.</p>

About the Test Set
Front-Panel Features (E6607C)

Item		Description
#	Name	
6	MPA RFIO, Ports 0 - 7	RF input and output connections to the DUTs (SMA connectors). The maximum safe input level at any of these ports is 2 W (+33 dBm), ± 15 Vdc.
7	GPS, Ports 0 - 3	RF input and output connections to the DUTs (SMA connectors). The maximum safe input level at any of these ports is 0.25 W (+24 dBm), 0 Vdc. Because GPS Ports 0 - 3 are the outputs of a four-way splitter, the maximum output power levels from these ports are lower than for RFIO Ports 0 - 7; see the E6607C data sheet for specifics.
8	RF OUT	GPS RF output port (communicates only with the source). The maximum safe input level at any of these ports is 0.25 W (+24 dBm), 0 Vdc.
9	DIST IN	GPS RF distribution input port (SMA connector). This port is connected to the four-way splitter that provides the signal to the 4 GPS output Ports 0 - 3. The maximum safe input level at any of these ports is 0.25 W (+24 dBm), 0 Vdc.
10	RF OUT	Tx/DL RF output port (communicates only with the source). The maximum safe input level at any of these ports is 0.25 W (+24 dBm), ± 15 Vdc.
11	MPA IN	Tx/DL MPA RF input port (SMA connector). The maximum safe input level at any of these ports is 0.25 W (+24 dBm), ± 15 Vdc.
12	RF IN	Rx/UL RF input port (communicates only with the analyzer). The maximum safe input level at any of these ports is 0.25 W (+24 dBm), ± 15 Vdc.
13	MPA OUT	Rx/UL RF MPA output port (SMA connector). The maximum safe input level at any of these ports is 0.25 W (+24 dBm), ± 15 Vdc.

Overview of key types

The keys labeled **FREQ Channel**, **System**, and **Marker Function** are all examples of front-panel keys.



Most of the dark or light gray keys access menus of functions that are displayed along the right side of the display. These displayed key labels are next to a column of keys called menu keys.

Menu keys list functions based on which front-panel key was pressed last. These functions are also dependant on the current selection of measurement application (**Mode**) and measurement (**Meas**).

If the numeric value of a menu key function can be changed, it is called an active function. The function label of the active function is highlighted after that key has been selected. For example, press **AMPTD Y Scale**. This calls up the menu of related amplitude functions. The function labeled **Ref Level** (the default selected key in the Amplitude menu) is highlighted. **Ref Level** also appears in the upper left of the display in the measurement information area. The displayed value indicates that the function is selected and its value can now be changed using any of the data entry controls.



Some menu keys have multiple choices on their label, such as **On/Off** or **Top/Ctr/Bot** (as shown below). The different choices are selected by pressing the key multiple times. For example, the Auto/Man type of key. To select the function, press the menu key and notice that Auto is underlined and the key becomes highlighted. To change the function to manual, press the key again so that Man is underlined. If there are

About the Test Set

Overview of key types

more than two settings on the key, keep pressing it until the desired selection is underlined.

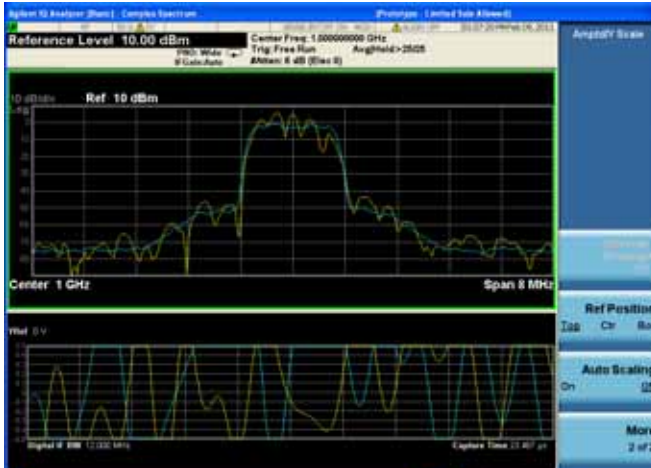

When a menu first appears, one key label is highlighted to show which key is the default selection. If you press **Marker Function**, the **Marker Function Off** key is the menu default key, and is highlighted.



Some of the menu keys are grouped together by a yellow bar running behind the keys near the left side or by a yellow border around the group of keys. When you press a key within the yellow region, such as **Marker Noise**, the highlight moves to that key to show it has been selected. The keys that are linked are related functions, and only one of them can be selected at any one time. For example, a marker can only have one marker function active on it. So if you select a different function it turns off the previous selection. If the current menu is two pages long, the yellow bar or border could include keys on the

second page of keys.



In some key menus, a key label is highlighted to show which key has been selected from multiple available choices. And the menu is immediately exited when you press one of the other keys. For example, when you press the **Select Marker** key (in the **Marker** menu), it brings up its own menu of keys. The **Marker 1** key is highlighted. When you press the **marker 2** key, the highlight moves to that key and the screen returns to the **Marker** menu.



If a displayed key label shows a small solid-black arrow tip pointing to the right, it indicates that additional key menus are available. If the arrow tip is not filled in solid then pressing the key the first time selects that function. Now the arrow is solid and pressing it again brings up an additional menu of

About the Test Set

Overview of key types

settings.

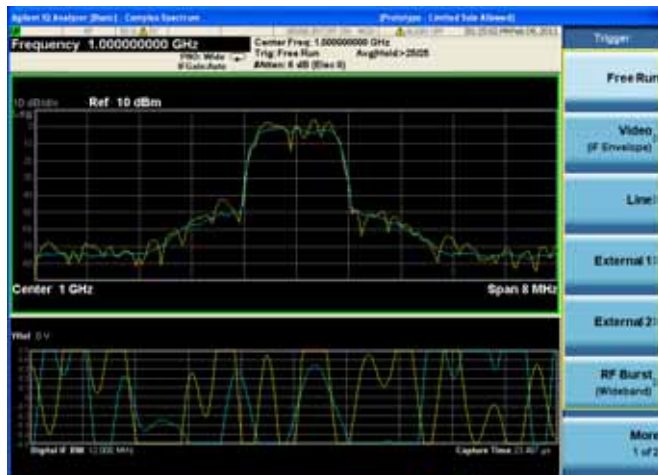

Open Arrow Tip

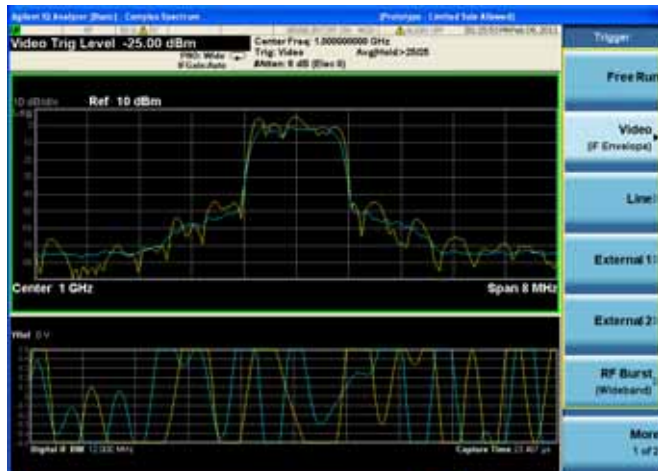

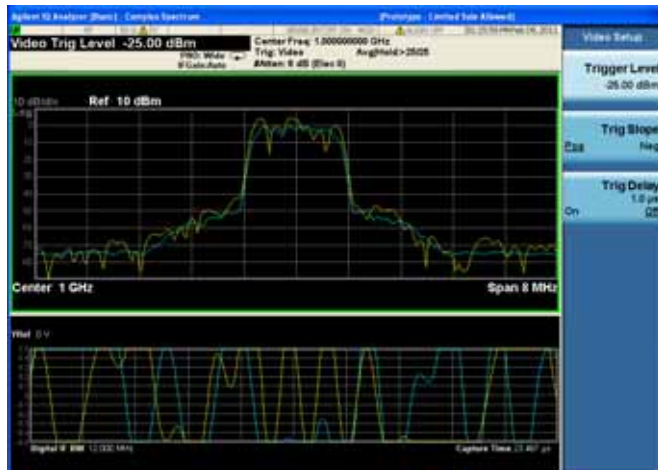
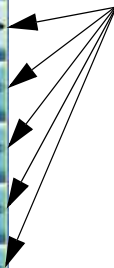

Solid Arrow Tip

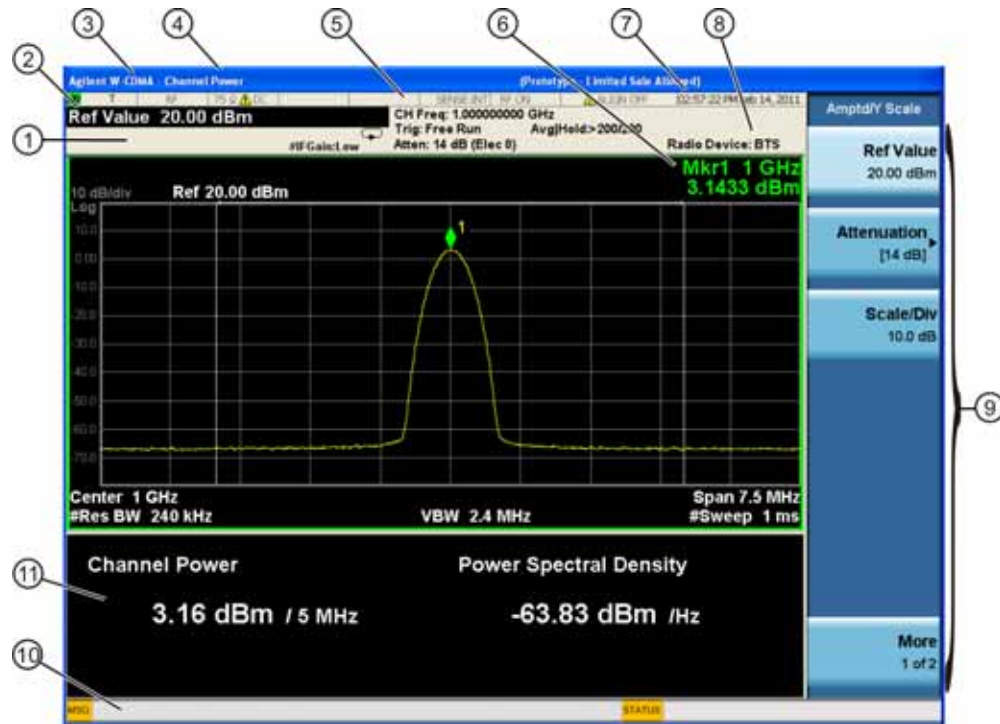

Display Annotations

This section describes the display annotation as it is on the Sequence Analyzer measurement application display. Other measurement application modes have some annotation differences.



Item	Description	Function Keys
1	Measurement bar - Shows general measurement settings and information.   Indicates single/continuous measurement. Some measurements include limits that the data is tested against. A Pass/Fail indication may be shown in the lower left of the measurement bar.	All the keys in the test set Setup part of the front panel.
2	Active Function (measurement bar) - when the current active function has a settable numeric value, it is shown here.	Currently selected front panel key.
3	Banner - shows the name of the selected application that is currently running.	Mode

About the Test Set
Display Annotations

Item	Description	Function Keys
4	Measurement title - shows title information for the current measurement, or a title that you created for the measurement.	Meas View/Display, Display, Title
5	Settings panel - displays system information that is not specific to any one application. <ul style="list-style-type: none"> • Input/Output status - RLTS indicate Remote, Listen, Talk, SRQ • Input impedance and coupling • Selection of external frequency reference • Setting of automatic internal alignment routine 	Local and System, I/O Config Input/Output, Amplitude, System and others
6	Active marker frequency, amplitude or function value	Marker
7	Settings panel - time and date display.	System, Control Panel
8	Trace and detector information	Trace/Detector, Clear Write (W) Trace Average (A) Max Hold (M) Min Hold (m) Trace/Detector, More, Detector, Average (A) Normal (N) Peak (P) Sample (S) Negative Peak (p)
9	Key labels that change based on the most recent key press.	Softkeys
10	Displays information, warning and error messages. Message area - single events, Status area - conditions	
11	Measurement settings for the data currently being displayed in the graticule area. In the example above: center frequency, resolution bandwidth, video bandwidth, frequency span, sweep time and number of sweep points.	Keys in the test set Setup part of the front panel.

Test Set Display Indicators

The display of the EXT Test Set includes, in the measurement bar, a field (highlighted in red below) which indicates the state of the internal source. When using the E6607A/B with the Multiport Adapter or when using the E6607C, this display is modified to indicate which output ports of the Multiport Adapter (if any) are supplying RF output power.

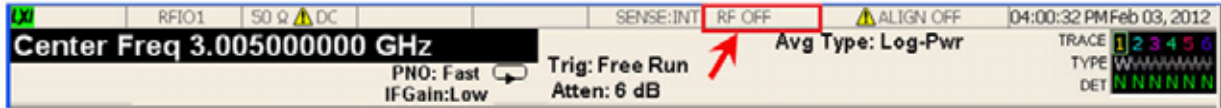

The table below illustrates the content of this field under different circumstances.

Multiport Adapter Usage	In Sequence Analyzer Mode	Not in Sequence Analyzer Mode, RF On	Not in Sequence Analyzer Mode, RF Off
Any or all of the 8 “RFIO” ports are in use.	SEQ MPA	RF ON MPA	RF OFF MPA
The 4 “GPS” ports are in use.	SEQ MPA-G	RF ON MPA-G	RF OFF MPA-G
Multiport Adapter is not in use.	SEQ	RF ON	RF OFF

Rear-Panel Features

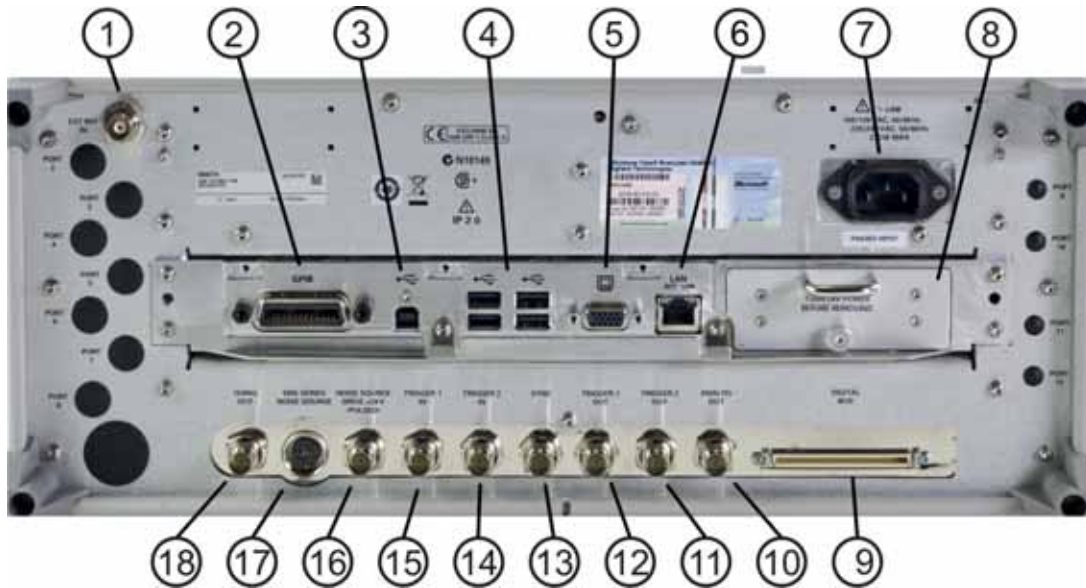

Item		Description
#	Name	
1	EXT REF IN	Input for an external frequency reference signal: 1 to 50 MHz
2	GPIB	A General Purpose Interface Bus (GPIB, IEEE 488.1) connection that can be used for remote test set operation.
3	USB Connector	USB 2.0 port, Type B. USB TMC (test and measurement class) connects to an external pc controller to control the test set and for data transfers over a 480 Mbps link.
4	USB Connectors	Standard USB 2.0 ports, Type A. Connect to external peripherals such as a mouse, keyboard, printer, DVD drive, or hard drive.
5	MONITOR	Allows connection of an external VGA monitor.
6	LAN	A TCP/IP Interface that is used for remote test set operation.
7	Line power input	The AC power connection. See the product specifications for more details.
8	Removable Hard Drive	Standard on E6607A.
9	DIGITAL BUS	Reserved for future use.
10	ANALOG OUT	Reserved for future use.
11	TRIGGER 2 OUT	A trigger output used to synchronize other test equipment with the test set. Configurable from the Input/Output keys.

Item		Description
#	Name	
12	TRIGGER 1 OUT	A trigger output used to synchronize other test equipment with the test set. Configurable from the Input/Output keys.
13	SYNC	Reserved for future use.
14	TRIGGER 2 IN	Allows external triggering of measurements.
15	TRIGGER 1 IN	Allows external triggering of measurements.
16	NOISE SOURCE DRIVE +28 V (PULSED)	Not functional in the EXT Test Set.
17	SNS SERIES NOISE SOURCE	Not functional in the EXT Test Set.
18	10 MHz OUT	An output of the test set internal 10 MHz frequency reference signal. It is used to lock the frequency reference of other test equipment to the test set.

Window Control Keys

The instrument provides three front-panel keys for controlling windows. They are Multi Window, Zoom, and Next Window. These are all “immediate action” keys.

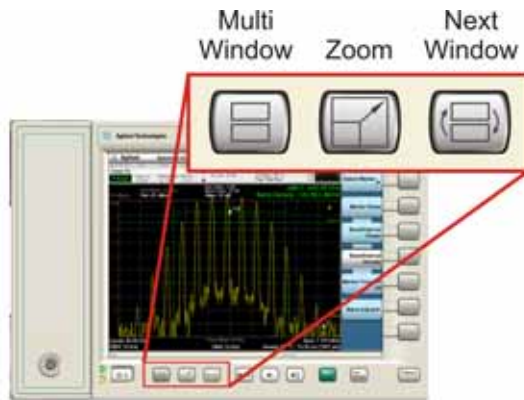

Multi-Window

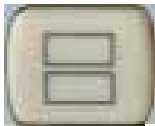

The **Multi Window** front-panel key will toggle you back and forth between the Normal View and the last Multi Window View (Zone Span, Trace Zoom or Spectrogram) that you were in, when using the Swept SA measurement of the Spectrum Analyzer Mode. It remembers which View you were in through a Preset. This “previous view” is set to Zone Span on a Restore Mode Defaults.

Key Path:	Front-panel key
Initial S/W Revision:	Prior to A.02.00
Help Map ID:	3496

Zoom

Zoom is a toggle function. Pressing this key once increases the size of the selected window; pressing the key again returns the window to the original size.

When Zoom is on for a window, that window will get the entire primary display area. The zoomed window, since it is the selected window, is outlined in green.

Zoom is local to each Measurement. Each Measurement remembers its Zoom state. The Zoom state of each Measurement is part of the Mode’s state.

NOTE Data acquisition and processing for the other windows continues while a window

is zoomed, as does all SCPI communication with the other windows.

Remote Command:	:DISPlay:WINDow:FORMat:ZOOM
Remote Command:	:DISPlay:WINDow:FORMat:TILE
Example:	:DISP:WIND:FORM:ZOOM sets zoomed :DISP:WIND:FORM:TILE sets un-zoomed
Preset:	TILE
Initial S/W Revision:	Prior to A.02.00
Help Map ID:	3497

Next Window

Selects the next window of the current view. When the Next Window key is pressed, the next window in the order of precedence becomes selected. If the selected window was zoomed, the next window will also be zoomed.

The window numbers are as follows. Note that these numbers also determine the order of precedence (that is, Next Window goes from 1 to 2, then 2 to 3, etc.):



Four window display

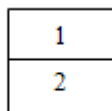

Two window display

Remote Command:	:DISPlay:WINDow[:SElect] <number> :DISPlay:WINDow[:SElect]?
Example:	:DISP:WIND 1
Preset:	1
Min:	1
Max:	If <number> is greater than the number of windows, limit to <number of windows>
Initial S/W Revision:	Prior to A.02.00
Help Map ID:	0

One and only one window is always selected. The selected window has the focus; this means that all window-specific key presses apply only to that window. You can tell which window is selected by the thick green border around it. If a window is not selected, its boundary is gray.

If a window in a multi-window display is zoomed it is still outlined in green. If there is only one window,

About the Test Set
Window Control Keys

the green outline is not used. This allows the user to distinguish between a zoomed window and a display with only one window.

The selected window is local to each Measurement. Each Measurement remembers which window is selected. The selected window for each Measurement is remembered in Mode state.

NOTE When this key is pressed in Help Mode, it toggles focus between the table of contents window and the topic pane window.

Mouse and Keyboard Control

If you do not have access to the instrument front-panel, there are several ways that a mouse and PC Keyboard can give you access to functions normally accessed using the front-panel keys.

NOTE **E6607C:** When using the E6607C there is no instrument front-panel. Therefore, the PC mouse and monitor are required for instrument control through a virtual front panel (VFP). For ease in using the VFP, the PC keyboard is recommended.

Right-Click

If you plug in a mouse and right-click on the analyzer screen, a menu will appear as below:

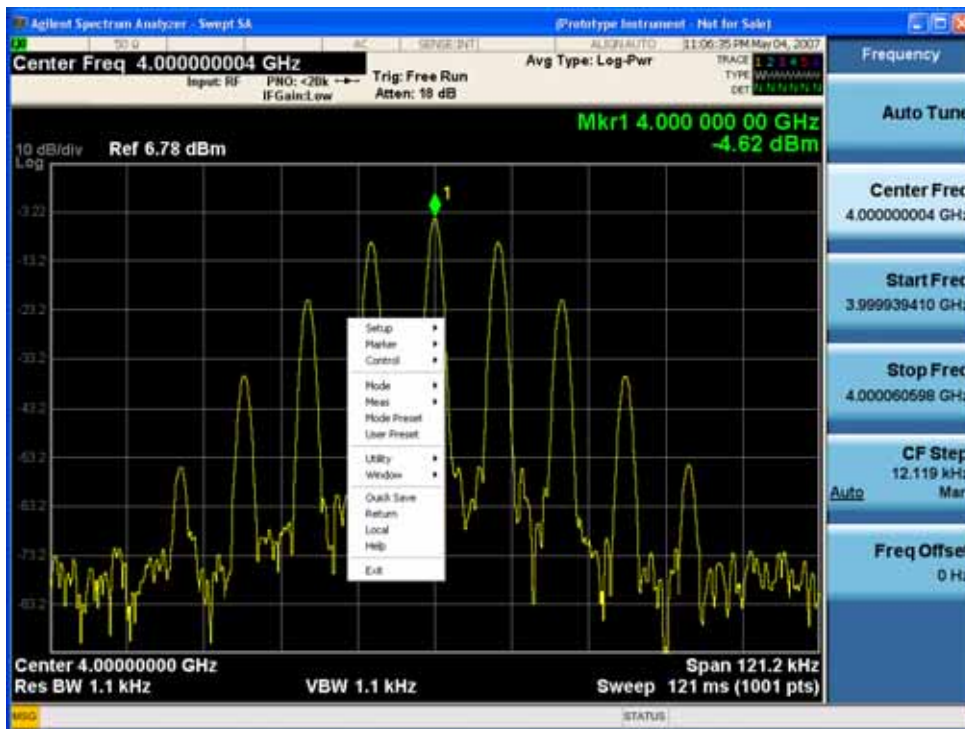

Placing the mouse on one of the rows marked with a right arrow symbol will cause that row to expand, as for example below where the mouse is hovered over the “Utility” row:

About the Test Set Mouse and Keyboard Control

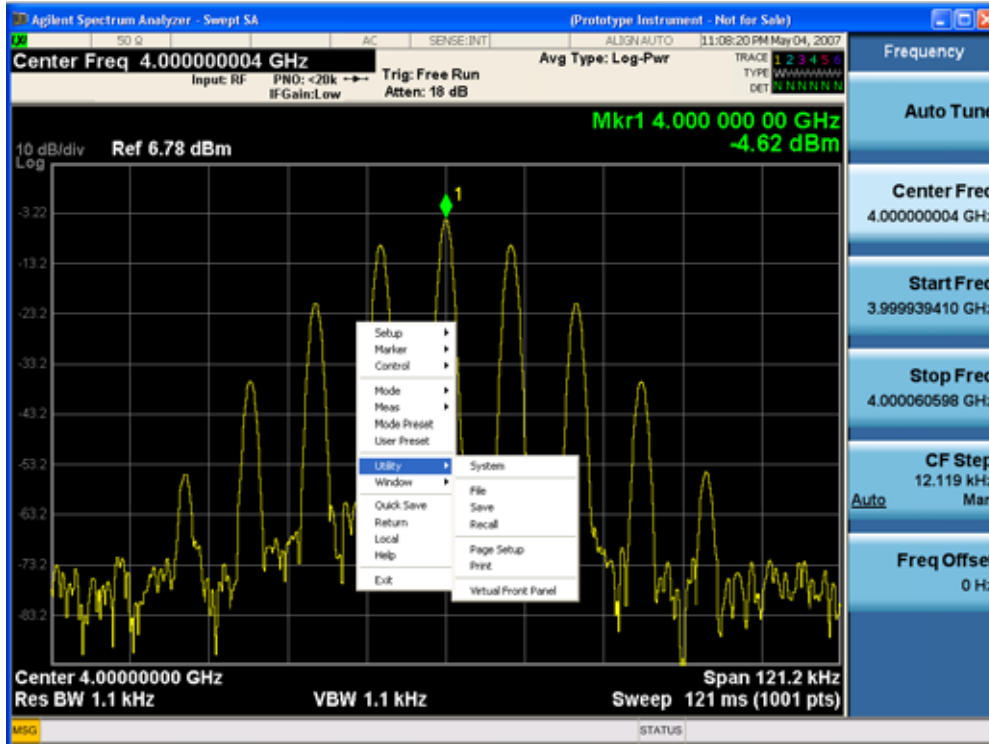

This method can be used to access any of the front-panel keys by using a mouse; as for example if you are accessing the instrument through Remote Desktop.

The array of keys thus available is shown below:

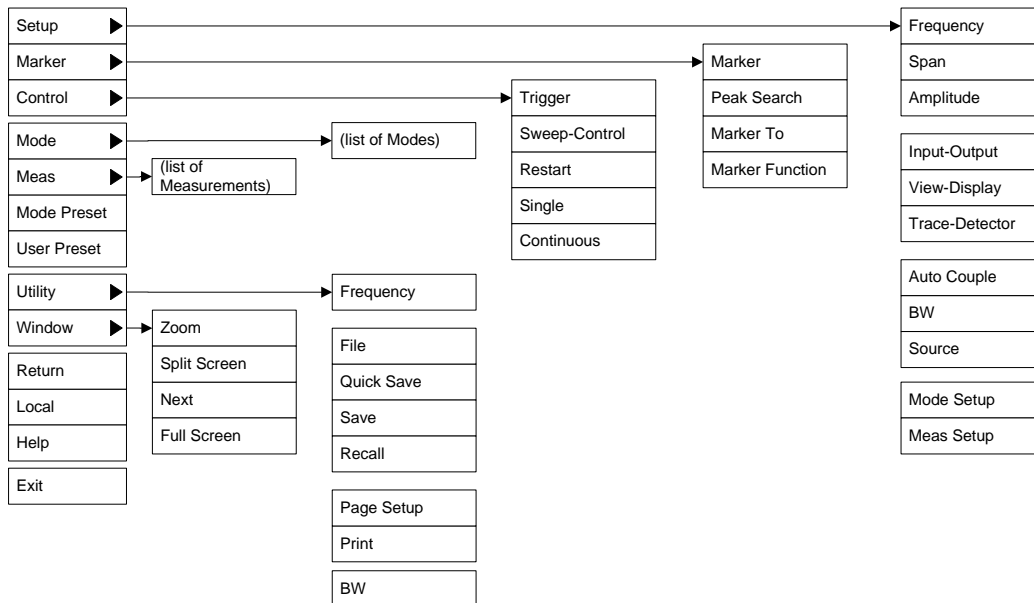

Virtual Front Panel

If you have a PC mouse, monitor, and keyboard plugged in (or through a Remote Desktop), you can navigate the front panel using the virtual front panel (VFP) shown below. Access the VFP as follows:

1. Right-click the mouse as described in [“Right-Click” on page 173](#).
2. Left-click Utility (1) in the menu, as shown below.
3. Left-click Virtual Front Panel (2) in the menu, as shown below.

NOTE The PC mouse and monitor are required when using the E6607C. For ease in using the VFP, the PC keyboard is recommended.

:

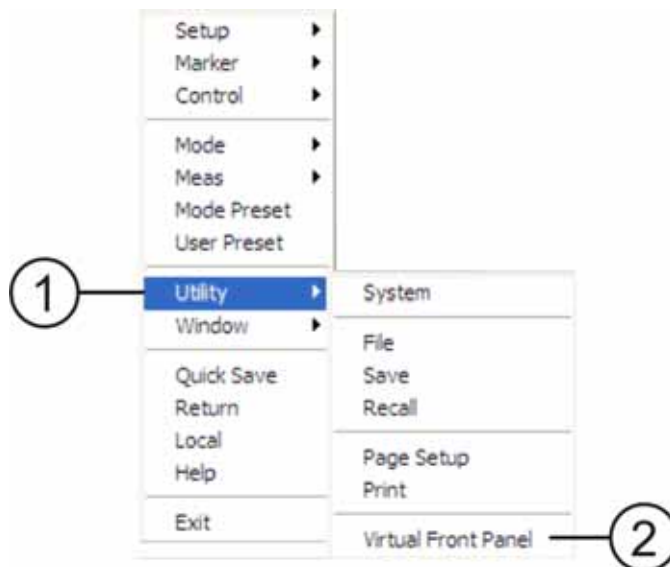

When the VFP opens, the keys behave just as the front-panel and menu keys described in [“Front-Panel Features \(E6607A/B\)” on page 152](#) and [“Overview of key types” on page 161](#). On the VFP the keys labeled "Key 1" through "Key 7" function as the menu keys. Using the mouse to click on a combination of the VFP keys and the menu keys on the display screen, you can operate the instrument just as you would using the front-panel of the E6607A/B.

About the Test Set
Mouse and Keyboard Control



PC Keyboard

If you have a PC keyboard plugged in (or via Remote Desktop), certain key codes on the PC keyboard map to front-panel keys on the GPSA front panel. These key codes are shown below:

Front-panel key	Key code
Frequency	CTRL+SHIFT+F
Span	CTRL+SHIFT+S
Amplitude	CTRL+SHIFT+A
Input/Output	CTRL+SHIFT+O
View/Display	CTRL+SHIFT+V
Trace/Detector	CTRL+ALT+T
Auto Couple	CTRL+SHIFT+C
Bandwidth	CTRL+ALT+B
Source	CTRL+ALT-U

Front-panel key	Key code
Marker	CTRL+ALT+K
Peak Search	CTRL+ALT+P
Marker To	CTRL+ALT+N
Marker Function	CTRL+ALT+F
System	CTRL+SHIFT+Y
Quick Save	CTRL+Q
Save	CTRL+S
Recall	CTRL+R
Mode Preset	CTRL+M
User Preset	CTRL+U
Print	CTRL+P
File	CTRL+SHIFT+L
Mode	CTRL+SHIFT+M
Measure	CTRL+ALT+M
Mode Setup	CTRL+SHIFT+E
Meas Setup	CTRL+ALT+E
Trigger	CTRL+SHIFT+T
Sweep/Control	CTRL+SHIFT+W
Restart	CTRL+ALT+R
Single	CTRL+ALT+S
Cont	CTRL+ALT+C
Zoom	CTRL+SHIFT+Z
Next Window	CTRL+SHIFT+N
Split Screen	CTRL+L
Full Screen	CTRL+SHIFT+B
Return	CTRL+SHIFT+R
Mute	Mute
Inc Audio	Volume Up
Dec Audio	Volume Down
Help	F1

About the Test Set
Mouse and Keyboard Control

Front-panel key	Key code
Control	CTRL
Alt	ALT
Enter	Return
Cancel	Esc
Del	Delete
Backspace	Backspace
Select	Space
Up Arrow	Up
Down Arrow	Down
Left Arrow	Left
Right Arrow	Right
Menu key 1	CTRL+SHIFT+F1
Menu key 2	CTRL+SHIFT+F2
Menu key 3	CTRL+SHIFT+F3
Menu key 4	CTRL+SHIFT+F4
Menu key 5	CTRL+SHIFT+F5
Menu key 6	CTRL+SHIFT+F6
Menu key 7	CTRL+SHIFT+F7
Backspace	BACKSPACE
Enter	ENTER
Tab	Tab
1	1
2	2
3	3
4	4
5	5
6	6
7	7
8	8
9	9

Front-panel key	Key code
0	0

This is a pictorial view of the table:

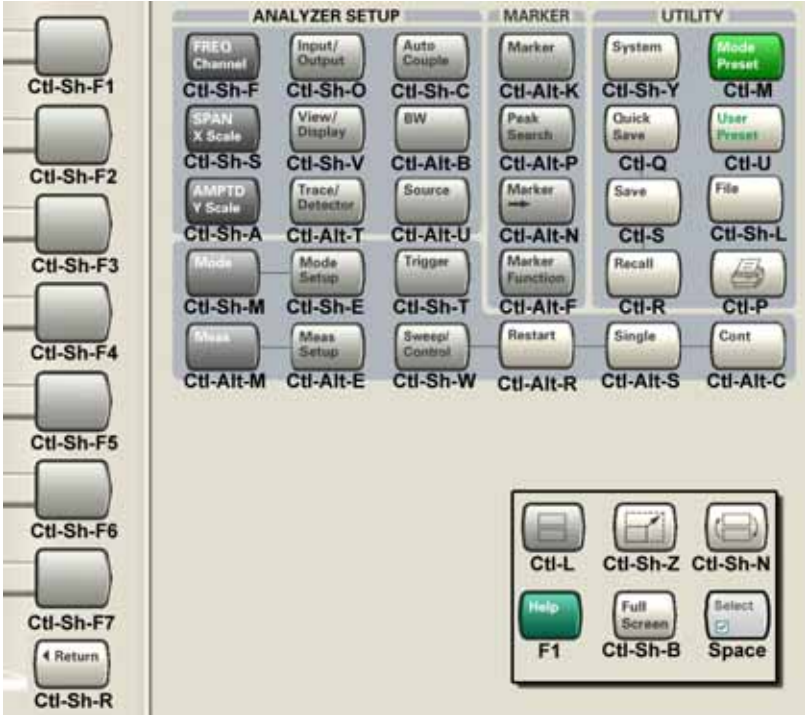

Instrument Security & Memory Volatility

If you are using the test set in a secure environment, you may need details of how to clear or sanitize its memory, in compliance with published security standards of the United States Department of Defense, or other similar authorities.

For the X Series test sets, this information is contained in the document "Security Features and Volatility". This document is **not** included in the test set's on-disk library, but it may be downloaded from Agilent's web site.

To obtain a copy of the document, click on or browse to the following URL:

<http://www.agilent.com/find/security>

To locate and download the document, select a Model Number, for example "E6607A", then click "Submit". Then, follow the on-screen instructions to download the file.

3

About the U9080A LTE Measurement Application

This section provides overall information on the Agilent U9080A LTE Measurement Application and describes the measurements made by the test set. Installation instructions for adding this option to your test set are provided in this section, in case you purchased this option separately.

What Does the Agilent U9080A LTE Measurement Application Do?

The U9080A LTE is a full-featured LTE signal analyzer that can help determine if a modulated source or transmitter is working correctly. There are standard and optional settings to enable complete analysis of LTE communications signals.

The U9080A 1FP LTE measurement application provides:

- Uplink (SC-FDMA), downlink (OFDMA), and Tx Diversity, MIMO analysis
- All LTE bandwidths: 1.4 MHz to 20 MHz
- All LTE modulation formats and sequences: BPSK, QPSK, 16QAM, 64QAM, CAZAC (Zadoff-Chu) Both downlink (OFDMA) and uplink (SC-FDMA) analysis
- Support for all LTE uplink channels and signals: PUSCH DM-RS, PUSCH, PUCCH DM-RS, and PUCCH
- Support for all LTE downlink channels and signals: RS, P-SS, S-SS, P-BCH, PDCCH, PCFICH, PHICH, and PDSCH
- View signal by: resource block, sub-carrier, slot, or symbol—select all or specific region for analysis. 2D graphical interface shows pictorial representation of user allocation
- Flexible display: Up to four simultaneous user-controllable trace displays
- Flexible markers: Up to 12 markers that can be coupled across different measurements
- X-Series front-panel operation with SCPI programmability

The U9080A 1FP LTE measurement application supports the following standards:

- 3GPP TS 36.101 V8.1.0 (2008-03)
- 3GPP TS 36.104 V8.1.0 (2008-03)
- 3GPP TS 36.211 V8.2.0 (2008-03)
- 3GPP TS 36.212 V8.2.0 (2008-03)
- 3GPP TS 36.213 V8.2.0 (2008-03)

This chapter provides introductory information about the programming documentation included with your test set.

What Programming Information is Available?

The X-Series Documentation can be accessed through the Additional Documentation page in the instrument Help system and is included on the Documentation CD shipped with the instrument. It can also be found in the instrument at: C:\ProgramsFiles\Agilent\SignalAnalysis\Infrastructure\Help\otherdocs, or online at: http://www.agilent.com/find/mxa_manuals.

The following resources are available to help you create programs for automating your X-Series measurements:

Resource	Description
X-Series Programmer's Guide	<p>Provides general SCPI programming information on the following topics:</p> <ul style="list-style-type: none"> • Programming the X-Series Applications • Programming fundamentals • Programming examples <p>Note that SCPI command descriptions for measurement applications are NOT in this book, but are in the User's and Programmer's Reference.</p>
User's and Programmer's Reference manuals	<p>Describes all front-panel keys and softkeys, including SCPI commands for a measurement application. Note that:</p> <ul style="list-style-type: none"> • Each measurement application has its own User's and Programmer's Reference. • The content in this manual is duplicated in the analyzer's Help (the Help that you see for a key is identical to what you see in this manual).
Embedded Help in your instrument	<p>Describes all front-panel keys and softkeys, including SCPI commands, for a measurement application.</p> <p>Note that the content that you see in Help when you press a key is identical to what you see in the User's and Programmer's Reference.</p>
X-Series Getting Started Guide	<p>Provides valuable sections related to programming including:</p> <ul style="list-style-type: none"> • Licensing New Measurement Application Software - After Initial Purchase • Configuring instrument LAN Hostname, IP Address, and Gateway Address • Using the Windows XP Remote Desktop to connect to the instrument remotely • Using the Embedded Web Server Telnet connection to communicate SCPI <p>This printed document is shipped with the instrument.</p>
Agilent Application Notes	Printable PDF versions of pertinent application notes.
Agilent VISA User's Guide	Describes the Agilent Virtual Instrument Software Architecture (VISA) library and shows how to use it to develop I/O applications and instrument drivers on Windows PCs.

IEEE Common GPIB Commands

Numeric values for bit patterns can be entered using decimal or hexi-decimal representations. (that is,. 0 to 32767 is equivalent to #H0 to #H7FFF).

Calibration Query

*CAL? Performs a full alignment and returns a number indicating the success of the alignment. A zero is returned if the alignment is successful. A one is returned if any part of the alignment fails. The equivalent SCPI command is CALibrate[:ALL]?

See “Alignments” on page 255 for details of *CAL?.

Clear Status

Clears the status byte register. It does this by emptying the error queue and clearing all bits in all of the event registers. The status byte register summarizes the states of the other registers. It is also responsible for generating service requests.

Key Path:	No equivalent key. Related key System, Show Errors, Clear Error Queue
Remote Command:	*CLS
Example:	*CLS Clears the error queue and the Status Byte Register.
Notes:	For related commands, see the SYSTem:ERRor[:NEXT]? command. See also the STATus:PRESet command and all commands in the STATus subsystem.
Status Bits/OPC dependencies:	Resets all bits in all event registers to 0, which resets all the status byte register bits to 0 also.
Backwards Compatibility Notes:	In general the status bits used in the X-Series status system will be backwards compatible with ESA and PSA. However, note that all conditions will generate events that go into the event log, and some will also generate status bits.
Initial S/W Revision:	Prior to A.02.00
Help Map ID:	0

Standard Event Status Enable

Selects the desired bits from the standard event status enable register. This register monitors I/O errors and synchronization conditions such as operation complete, request control, query error, device dependent error, status execution error, command error, and power on. The selected bits are OR'd to become a summary bit (bit 5) in the byte register which can be queried.

The query returns the state of the standard event status enable register.

Key Path:	No equivalent key. Related key System, Show Errors, Clear Error Queue
-----------	--

Remote Command:	*ESE <integer> *ESE?
Example:	*ESE 36 Enables the Standard Event Status Register to monitor query and command errors (bits 2 and 5). *ESE? Returns a 36 indicating that the query and command status bits are enabled.
Notes:	For related commands, see the <i>STATUS</i> subsystem and <i>SYSTEM:ERROR[:NEXT]?</i> commands.
Preset:	255
State Saved:	Not saved in state.
Min:	0
Max:	255
Status Bits/OPC dependencies:	Event Enable Register of the Standard Event Status Register.
Initial S/W Revision:	Prior to A.02.00
Help Map ID:	0

Standard Event Status Register Query

Queries and clears the standard event status event register. (This is a destructive read.) The value returned is a hexadecimal number that reflects the current state (0/1) of all the bits in the register.

Remote Command:	*ESR?
Example:	*ESR? Returns a 1 if there is either a query or command error, otherwise it returns a zero.
Notes:	For related commands, see the <i>STATUS</i> subsystem commands.
Preset:	0
Min:	0
Max:	255
Status Bits/OPC dependencies:	Standard Event Status Register (bits 0 – 7).
Initial S/W Revision:	Prior to A.02.00
Help Map ID:	0

Identification Query

Returns a string of instrument identification information. The string will contain the model number, serial number, and firmware revision.

The response is organized into four fields separated by commas. The field definitions are as follows:

Manufacturer
Model
Serial number
Firmware version

Key Path:	No equivalent key. See related key System, Show System.
Remote Command:	*IDN?
Example:	*IDN? Returns instrument identification information, such as: Agilent Technologies,N9020A,US01020004,A.01.02
Initial S/W Revision:	Prior to A.02.00
Help Map ID:	0

Instrument Model Number

ID? - Returns a string of the instrument identification. The string will contain the model number.

When in Remote Language compatibility mode the query will return the model number of the emulated instrument, when in any other mode the returned model number will be that of the actual hardware.

Operation Complete

The *OPC command sets bit 0 in the standard event status register (SER) to “1” when pending operations have finished, that is when all overlapped commands are complete. It does not hold off subsequent operations. You can determine when the overlapped commands have completed either by polling the OPC bit in SER, or by setting up the status system such that a service request (SRQ) is asserted when the OPC bit is set.

The *OPC? query returns a “1” after all the current overlapped commands are complete. So it holds off subsequent commands until the "1" is returned, then the program continues. This query can be used to synchronize events of other instruments on the external bus.

Remote Command:	*OPC *OPC?
Example:	INIT:CONT 0 Selects single sweeping. INIT:IMM Initiates a sweep. *OPC? Holds off any further commands until the sweep is complete.
Status Bits/OPC dependencies:	Not global to all remote ports or front panel. *OPC only considers operation that was initiated on the same port as the *OPC command was issued from. *OPC is an overlapped command, but *OPC? is sequential.

Backwards Compatibility Notes:	<p>The ESA/PSA/VSA products do not meet all the requirements for the *OPC command specified by IEEE 488.2. This is corrected for X-Series. This will sometimes cause behavior that is not backward compatible, but it will work as customers expect.</p> <p>Commands such as, *OPC/*OPC?/*WAI/*RST used to be global. They considered front panel operation in conjunction with the GPIB functionality. Now they are evaluated on a per channel basis. That is, the various rear panel remote ports and the front panel i/o are all considered separately. Only the functionality initiated on the port where the *OPC was sent, is considered for its operation.</p> <p>*OPC used to hold off until the operation bits were cleared. Now it holds off until all overlapping commands are completed. Also, earlier instruments did not wait for completion of all processes, only the ones identified here (in the STATus:OPERation register):</p> <p>Calibrating: monitored by PSA, ESA, VSA (E4406A)</p> <p>Sweeping: monitored by PSA, ESA, VSA (E4406A)</p> <p>Waiting for Trigger: monitored by PSA, ESA, VSA (E4406A)</p> <p>Measuring: monitored by PSA and ESA (but not in all Modes).</p> <p>Paused: monitored by VSA (E4406A).</p> <p>Printing: monitored by VSA (E4406A).</p> <p>Mass memory busy: monitored by VSA (E4406A).</p>
Initial S/W Revision:	Prior to A.02.00
Help Map ID:	0

Query Instrument Options

Returns a string of all the installed instrument options. It is a comma separated list with quotes, such as: “503,P03,PFR”.

To be IEEE compliant, this command should return an arbitrary ascii variable that would not begin and end with quotes. But the quotes are needed to be backward compatible with previous SA products and software. So, the actual implementation will use arbitrary ascii. But quotes will be sent as the first and last ascii characters that are sent with the comma-separated option list.

Remote Command:	*OPT?
Initial S/W Revision:	Prior to A.02.00
Help Map ID:	0

Recall Instrument State

This command recalls the instrument state from the specified instrument memory register.

If the state being loaded has a newer firmware revision than the revision of the instrument, no state is recalled and an error is reported

If the state being loaded has an equal firmware revision than the revision of the instrument, the state will be loaded.

If the state being loaded has an older firmware revision than the revision of the instrument, the instrument will only load the parts of the state that apply to the older revision.

Remote Command:	*RCL <register #>
Example:	*RCL 7 Recalls the instrument state that is currently stored in register 7.
Notes:	Registers 0 through 6 are accessible from the front panel in menu keys for Recall Registers.
Min:	0
Max:	127
Status Bits/OPC dependencies:	The command is sequential.
Initial S/W Revision:	Prior to A.02.00
Help Map ID:	0

Save Instrument State

This command saves the current instrument state and mode to the specified instrument memory register.

Remote Command:	*SAV <register #>
Example:	*SAV 9 Saves the instrument state in register 9.
Notes:	Registers 0 through 6 are accessible from the front panel in menu keys for Save Registers.
Min:	0
Max:	127
Status Bits/OPC dependencies:	The command is sequential.
Initial S/W Revision:	Prior to A.02.00
Help Map ID:	0

Service Request Enable

This command enables the desired bits of the service request enable register.

The query returns the value of the register, indicating which bits are currently enabled.

Remote Command:	*SRE <integer> *SRE?
Example:	*SRE 22 Enables bits 1, 2, and 4 in the service request enable register.

Notes:	For related commands, see the STATus subsystem and SYSTem:ERRor[:NEXT]? commands.
Preset:	0
Min:	0
Max:	255
Status Bits/OPC dependencies:	Service Request Enable Register (all bits, 0 – 7).
Initial S/W Revision:	Prior to A.02.00
Help Map ID:	0

Status Byte Query

Returns the value of the status byte register without erasing its contents.

Remote Command:	*STB?
Example:	*STB? Returns a decimal value for the bits in the status byte register. For example, if a 16 is returned, it indicates that bit 5 is set and one of the conditions monitored in the standard event status register is set.
Notes:	See related command *CLS.
Status Bits/OPC dependencies:	Status Byte Register (all bits, 0 – 7).
Initial S/W Revision:	Prior to A.02.00
Help Map ID:	0

Trigger

This command triggers the instrument. Use the :TRIGger[:SEQuence]:SOURce command to select the trigger source.

Key Path:	No equivalent key. See related keys Single and Restart.
Remote Command:	*TRG
Example:	*TRG Triggers the instrument to take a sweep or start a measurement, depending on the current instrument settings.
Notes:	See related command :INITiate:IMMediate.
Initial S/W Revision:	Prior to A.02.00
Help Map ID:	0

Self Test Query

This query performs the internal self-test routines and returns a number indicating the success of the

testing. A zero is returned if the test is successful, 1 if it fails.

Remote Command:	*TST?
Example:	*TST? Runs the self-test routines and returns 0=passed, 1=some part failed.
Initial S/W Revision:	Prior to A.02.00
Help Map ID:	0

Wait-to-Continue

This command causes the instrument to wait until all overlapped commands are completed before executing any additional commands. There is no query form for the command.

Remote Command:	*WAI
Example:	INIT:CONT OFF; INIT;*WAI Sets the instrument to single sweep. Starts a sweep and waits for its completion.
Status Bits/OPC dependencies:	Not global to all remote ports or front panel. *OPC only considers operation that was initiated on the same port as the *OPC command was issued from.
Initial S/W Revision:	Prior to A.02.00
Help Map ID:	0

File

Opens a menu that enables you to access various standard and custom Windows functions. Press any other front-panel key to exit

Key Path:	Front-panel key
Initial S/W Revision:	Prior to A.02.00
Help Map ID:	2200

File Explorer

Opens the standard Windows File Explorer. The File Explorer opens in the My Documents directory for the current user.

The File Explorer is a separate Windows application, so to return to the analyzer once you are in the File Explorer, you may either:

Exit the File Explorer by clicking on the red X in the upper right hand corner, with a mouse

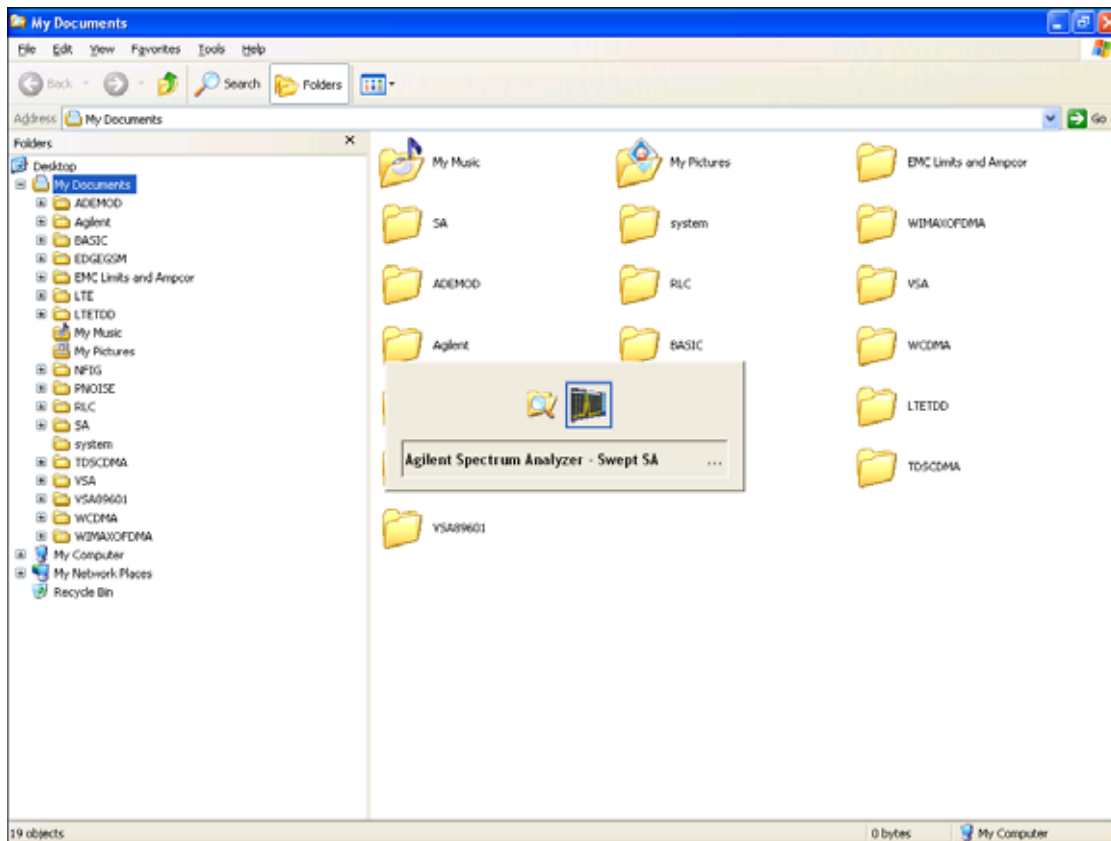

Or use Alt-Tab: press and hold the Alt key and press and release the Tab key until the Analyzer

logo is showing in the window in the center of the screen, as shown above, then release the Alt key.

Key Path:	File
Initial S/W Revision:	Prior to A.02.00
Help Map ID:	2201

Page Setup

The Page Setup key brings up a Windows Page Setup dialog that allows you to control aspects of the pages sent to the printer when the PRINT hardkey is pressed.

Key Path:	File
Initial S/W Revision:	Prior to A.02.00
Help Map ID:	3513

Paper size, the printer paper source, the page orientation and the margins are all settable. Just like any standard Windows dialog, you may navigate the dialog using the front-panel keys, or a mouse. There are no SCPI commands for controlling these parameters.

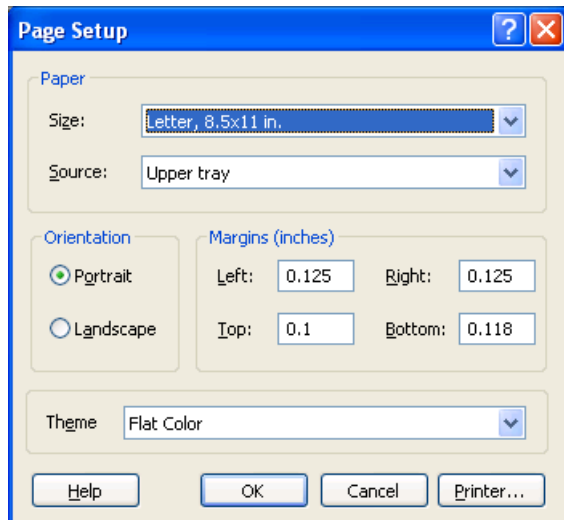

Also contained in this dialog is a drop-down control that lets you select the Theme to use when printing. For more on Themes, see information under View/Display, Display, System Display Settings, Theme. The Theme control has a corresponding SCPI command.

Parameter Name:	Print Themes
Parameter Type:	Enum
Mode:	All

Remote Command:	:SYSTem:PRINT:THEMe TDCoLor TDMonochrome FCoLoR FMONochrome :SYSTem:PRINT:THEMe?
Example:	:SYST:PRIN:THEM FCOL
Setup:	:SYSTem:DEFault MISC
Preset:	FCOL; not part of Preset, but is reset by Restore Misc Defaults or Restore System Defaults All and survives subsequent running of the modes.
State Saved:	No
Initial S/W Revision:	Prior to A.02.00
Help Map ID:	0

Print

The Print key opens a Print dialog for configured printing (for example, to the printer of your choice). Refer to your Microsoft Windows Operating System manual for more information.

Maximize/Restore Down

These keys allow the Instrument Application to be maximized and then restored to its prior state. Only one of the two keys is visible at a time. When not already maximized the Maximize Application key is visible, and when maximized, the Restore Down Application key is visible and replaces the Maximize Application key.

Maximize

This key allows you to Maximize the Instrument Application, which causes the analyzer display to fill the screen. Once the application is maximized, this key is replaced by the Restore Down key.

Key Path:	File
Mode:	All
Notes:	No equivalent remote command for this key.
State Saved:	No
Initial S/W Revision:	A.05.01
Help Map ID:	3668

Restore Down

This key allows you to Restore Down the Instrument Application and reverses the action taken by Maximize. This key is only visible when the application has been maximized, and after the Restore Down action has been completed this key is replaced by the Maximize key.

Key Path:	File
-----------	-------------

Mode:	All
Notes:	No equivalent remote command for this key.
State Saved:	No
Initial S/W Revision:	A.05.01
Help Map ID:	3669

Minimize

The Minimize key causes the analyzer display to disappear down into the task bar, allowing you to see

the Windows Desktop. You can use Alt-Tab (press and hold the Alt  key and press and release the Tab key) to restore the analyzer display.

Key Path:	File
Mode:	All
Notes:	No equivalent remote command for this key.
State Saved:	No
Initial S/W Revision:	A.05.01
Help Map ID:	3670

Exit

This key, when pressed, will exit the Instrument Application. A dialog box is used to confirm that you intended to exit the application:

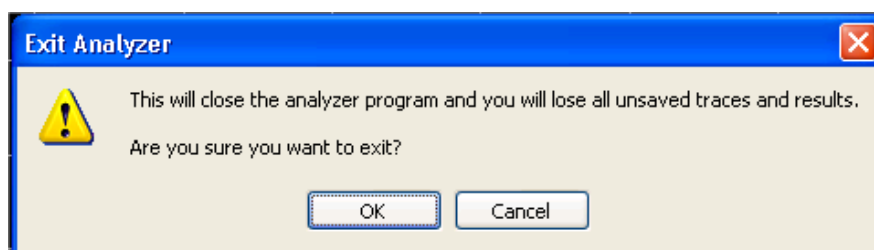

Key Path:	File
Mode:	All
Notes:	The Instrument Application will close. No further SCPI commands can be sent. Use with caution!
Initial S/W Revision:	Prior to A.02.00
Help Map ID:	2202

Mode Preset

Returns the active mode to a known state.

Mode Preset does the following for the currently active mode:

Aborts the currently running measurement.

Brings up the default menu for the mode, with no active function.

Sets measurement Global settings to their preset values for the active mode only.

Activates the default measurement.

Brings up the default menu for the mode.

Clears the input and output buffers.

Sets Status Byte to 0.

Mode Preset does not:

Cause a mode switch

Affect mode persistent settings

Affect system settings

See [“How-To Preset” on page 199](#) for more information.

Key Path:	Front-panel key
Remote Command:	:SYSTem:PRESet
Example:	:SYST:PRES
Notes:	*RST is preferred over :SYST:PRES for remote operation. *RST does a Mode Preset, as done by the :SYST:PRES command, and it sets the measurement mode to Single measurement rather than Continuous for optimal remote control throughput. Clears all pending OPC bits. The Status Byte is set to 0.
Couplings:	A Mode Preset aborts the currently running measurement, activates the default measurement, and gets the mode to a consistent state with all of the default couplings set.

Backwards Compatibility Notes:	<p>In the X-Series, the legacy “Factory Preset” has been replaced with Mode Preset, which only presets the currently active mode, not the entire instrument. In the X-Series, the way in to preset the entire instrument is by using System, Restore System Defaults All, which behaves essentially the same way as restore System Defaults does on ESA and PSA.</p> <p>There is also no “Preset Type” as there is on the PSA. There is a green Mode Preset front-panel key that does a Mode Preset and a white-with-green-letters User Preset front-panel key that does a User Preset. The old PRESet:TYPE command is ignored (without generating an error), and SYST:PRES without a parameter does a Mode Preset, which should cover most backward code compatibility issues.</p> <p>The settings and correction data under the Input/Output front-panel key (examples: Input Z Corr, Ext Amp Gain, etc.) are no longer part of any Mode, so they will not be preset by a Mode Preset. They are preset using Restore Input/Output Defaults, Restore System Defaults All. Note that because User Preset does a Recall State, and all of these settings are saved in State, they ARE recalled when using User Preset.</p>
Initial S/W Revision:	Prior to A.02.00
Help Map ID:	2300

How-To Preset

The table below shows all possible presets, their corresponding SCPI commands and front-panel access (key paths). Instrument settings depend on the current measurement context. Some settings are local to the current measurement, some are global (common) across all the measurements in the current mode, and some are global to all the available modes. In a similar way, restoring the settings to their preset state can be done within the different contexts.

Auto Couple - is a measurement local key. It sets all Auto/Man parameter couplings in the measurement to Auto. Any Auto/Man selection that is local to other measurements in the mode will not be affected.

Meas Preset - is a measurement local key. Meas Preset resets all the variables local to the current measurement except the persistent ones.

Mode Preset - resets all the current mode's measurement local and measurement global variables except the persistent ones.

Restore Mode Defaults - resets ALL the Mode variables (and all the Meas global and Meas local variables), including the persistent ones.

Type Of Preset	SCPI Command	Front Panel Access
Auto Couple	:COUPle ALL	Auto Couple front-panel key
Meas Preset	:CONFigure:<Measurement>	Meas Setup Menu
Mode Preset	:SYSTem:PRESet	Mode Preset (green key)
Restore Mode Defaults	:INSTrument:DEFault	Mode Setup Menu

System Functions
Mode Preset

Type Of Preset	SCPI Command	Front Panel Access
Restore All Mode Defaults	:SYSTem:DEFault MODEs	System Menu; Restore System Default Menu
*RST	*RST	not possible (Mode Preset with Single)
Restore Input/Output Defaults	:SYSTem:DEFault INPut	System Menu; Restore System Default Menu
Restore Power On Defaults	:SYSTem:DEFault PON	System Menu; Restore System Default Menu
Restore Alignment Defaults	:SYSTem:DEFault ALIGn	System Menu; Restore System Default Menu
Restore Miscellaneous Defaults	:SYSTem:DEFault MISC	System Menu; Restore System Default Menu
Restore All System Defaults	:SYSTem:DEFault [ALL] :SYSTem:PRESet:PERsistent	System Menu; Restore System Default Menu
User Preset	:SYSTem:PRESet:USER	User Preset Menu
User Preset All Modes	:SYSTem:PRESet:USER:ALL	User Preset Menu
Power On Mode Preset	:SYSTem:PON:TYPE MODE	System Menu
Power On User Preset	:SYSTem:PON:TYPE USER	System Menu
Power On Last State	:SYSTem:PON:TYPE LAST	System Menu

Restore Mode Defaults

Resets the state for the currently active mode by resetting the mode persistent settings to their factory default values, clearing mode data and by performing a Mode Preset. This function will never cause a mode switch. This function performs a full preset for the currently active mode; whereas, Mode Preset performs a partial preset. Restore Mode Defaults does not affect any system settings. System settings are reset by the Restore System Defaults function. This function does reset mode data; as well as settings.

Key Path:	Mode Setup
Remote Command:	:INSTrument :DEFault
Example:	:INST:DEF
Notes:	Clears all pending OPC bits. The Status Byte is set to 0. A message comes up saying: "If you are sure, press key again".
Couplings:	A Restore Mode Defaults will cause the currently running measurement to be aborted and causes the default measurement to be active. It gets the mode to a consistent state with all of the default couplings set.
Initial S/W Revision:	Prior to A.02.00

Help Map ID:	2307
--------------	------

Meas Preset

Resets the measurement local variables for the currently active measurement to their factory default values. The measurement settings that get reset are the same ones that are reset during a Mode Preset. This function keeps the instrument in the current measurement and the current mode and does not affect the settings for other measurements, but does abort the currently running measurement.

Key Path:	Meas Setup
Remote Command:	:CONFigure:<Measurement>
Example:	:CONF:ACP immediately does a Meas Preset to the ACP measurement.
Notes:	Clears the Measuring bit :CONF:<Measurement> resets the specified measurement settings to default in ESA, VSA and PSA; in GPSA it allows the addition of the NDEFault node to the command to prevent a measurement preset from occurring after a measurement switch. :MEASure:<Measurement> also restores the default values of the selected measurement, but it also initiates the specified measurement.
Initial S/W Revision:	Prior to A.02.00
Help Map ID:	2306

Preset Type (Remote Command Only)

As stated in the Backward Compatibility section, to be compatible with ESA/PSA the PRESet:TYPE command will be implemented as a no-op.

Mode:	All
Remote Command:	:SYSTem:PRESet:TYPE FACTory MODE USER :SYSTem:PRESet:TYPE?
Example:	:SYST:PRESet:TYPE FACT
Notes:	This command is supported for backward compatibility only. It is a no-op which does not change the behavior of any preset operation.
Preset:	This is unaffected by Preset but is set to Mode on a "Restore System Defaults->All"
State Saved:	No
Initial S/W Revision:	Prior to A.02.00
Help Map ID:	0

***RST (Remote Command Only)**

*RST is equivalent to :SYST:PRES;:INIT:CONT OFF, which is a Mode Preset in the Single measurement state. This remote command is preferred over Mode Preset remote command - :SYST:PRES, as optimal remote programming occurs with the instrument in the single measurement state.

Remote Command:	*RST
Example:	*RST
Notes:	Sequential Clears all pending OPC bits and the Status Byte is set to 0.
Couplings:	A *RST will cause the currently running measurement to be aborted and cause the default measurement to be active. *RST gets the mode to a consistent state with all of the default couplings set.
Backwards Compatibility Notes:	In legacy analyzers *RST did not set the analyzer to Single, but in the X-Series it does, for compliance with the IEEE 488.2 specification. In the X-Series, *RST does not do a *CLS (clear the status bits and the error queue). In legacy analyzers, *RST used to do the equivalent of SYSTem:PRESet, *CLS and INITiate:CONTinuous OFF. But to be 488.2 compliant, *RST in the X-Series does not do a *CLS.
Initial S/W Revision:	Prior to A.02.00
Help Map ID:	2301

Print

This front-panel key is equivalent to performing a File, Print, OK. It immediately performs the currently configured Print to the Default printer.

The :HCOPY command is equivalent to pressing the PRINT key. The HCOPY:ABORT command can be used to abort a print which is already in progress. Sending HCOPY:ABORT will cause the analyzer to stop sending data to the printer, although the printer may continue or even complete the print, depending on how much data was sent to the printer before the user sent the ABORT command.

Key Path:	Front-panel key
Remote Command:	:HCOPY[:IMMEDIATE]
Initial S/W Revision:	Prior to A.02.00
Help Map ID:	3495

Key Path:	SCPI command only
Remote Command:	:HCOPY:ABORT
Initial S/W Revision:	Prior to A.02.00
Help Map ID:	0

Quick Save

The Quick Save front-panel key repeats the most recent save that was performed from the Save menu, with the following exceptions:

Register saves are not remembered as Saves for the purpose of the Quick Save function

If the current measurement does not support the last non-register save that was performed, an informational message is generated, “File type not supported for this measurement”

Quick Save repeats the last type of qualified save (that is, a save qualified by the above criteria) in the last save directory by creating a unique filename using the Auto File Naming algorithm described below.

If Quick Save is pressed after startup and before any qualified Save has been performed, the Quick Save function performs a Screen Image save using the current settings for Screen Image saves (current theme, current directory), which then becomes the “last save” for the purpose of subsequent Quick Saves.

The Auto File Naming feature automatically generates a file name for use when saving a file. The filename consists of a prefix and suffix separated by a dot, as is standard for the Windows® file system. A default prefix exists for each of the available file types:

Type	Default Prefix	Menu
State	State_	(Save/Recall)
Trace + State	State_	(Save/Recall)
Screen	Screen_	(Save/Recall)
Amplitude Corrections	Ampcor_	(Import/Export)
Traces	Trace_	(Import/Export)
Limit Lines	LLine_	(Import/Export)
Measurement Result	MeasR_	(Import/Export)
Capture Buffer	CapBuf_	(Import/Export)

A four digit number is appended to the prefix to create a unique file name. The numbering sequence starts at 0000 within each Mode for each file type and updates incrementally to 9999, then wraps to 0000 again. It remembers where it was through a Mode Preset and when leaving and returning to the Mode. It is reset by Restore Misc Defaults and Restore System Defaults and subsequent running of the instrument application. So, for example, the first auto file name generated for State files is State_0000.state. The next is State_0001, and so forth.

One of the key features of Auto File Name is that we guarantee that the Auto File Name will never conflict with an existing file. The algorithm looks for the next available number. If it gets to 9999, then it looks for holes. If it find no holes, that is no more numbers are available, it gives an error.

For example, if when we get to State_0010.state there is already a State_0010.state file in the current directory, it advances the counter to State_0011.state to ensure that no conflict will exist (and then it verifies that State_0011.state also does not exist in the current directory and advances again if it does,

and so forth).

If you enter a file name for a given file type, then the prefix becomes the filename you entered instead of the default prefix, followed by an underscore. The last four letters (the suffix) are the 4-digit number.

For example, if you save a measurement results file as “fred.csv”, then the next auto file name chosen for a measurement results save will be fred_0000.csv.

NOTE Although 0000 is used in the example above, the number that is used is actually the current number in the Meas Results sequence, that is, the number that would have been used if you had not entered your own file name.

NOTE If the filename you entered ends with _dddd, where d=any number, making it look just like an auto file name, then the next auto file name picks up where you left off with the suffix being dddd + 1.

Key Path:	Front-panel key
Notes:	No remote command for this key specifically.
Initial S/W Revision:	Prior to A.02.00
Help Map ID:	2635

Recall

The **Recall** menu lets you choose what you want to recall, and where you want to recall it from. Among the types of files you can recall are **States and Traces**. In addition, an **Import (Data)** option lets you recall a number of data types stored in CSV files (as used by Excel and other spreadsheet programs).

The default paths for Recall are data type dependent and are the same as for the Save key.

Key Path:	Front-panel key
Notes:	<p>No remote command for this key specifically, but the :MMEM:LOAD command is available for specific file types. An example is :MMEM:LOAD:STATe <filename>.</p> <p>If you try to recall a State file for a mode that is not licensed or not available in the instrument, an error message will occur and the state will not change.</p>
Backwards Compatibility Notes:	<p>In legacy analyzers, it was possible to load a state without affecting the trace data, limit lines or correction data. Similarly (since User Preset is actually loading a state), it was possible to do a User Preset without affecting the trace data, limit lines or correction data.</p> <p>In the X-Series, “state” always includes all of this data; so whenever state is loaded, all of the traces, limit lines and corrections are affected. Although this differs from previous behavior, it is desirable behavior, and should not cause adverse issues for users.</p>
Backwards Compatibility Notes:	<p>Recall for the X-Series supports backward compatibility in the sense that you can recall a state file from any X-Series model number and any version of X-Series software. If you try to recall a state file onto an instrument with less capability than what was available on the instrument during the save, the recall will ignore the state it doesn’t support and it will limit the recalled setting to what it allows.</p> <p>Example: if the saved state includes preamp ON, but the recalling instrument does not have a preamp; the preamp is limited to OFF. Conversely, if you save a state without a preamp, the preamp is OFF in the state file. When this saved file is recalled on an instrument with a licensed preamp, the preamp is changed to OFF. Another example is if the saved state has center frequency set to 20 GHz, but the instrument recalling the saved state is a different model and only supports 13.5 GHz. In this case, the center frequency is limited along with any other frequency based settings. Since the center frequency can’t be preserved in this case, the recall limiting tries to at least preserve span to keep the measurement setup as intact as possible.</p> <p>Note that there is no state file compatibility outside of the X-Series. For example, you cannot recall a state file from ESA or PSA.</p>
Initial S/W Revision:	Prior to A.02.00
Help Map ID:	2637

State

The **Recall State** menu lets you choose a register or file from which to recall the state.

The content of a state file includes all of the settings and data required to return the analyzer as closely as possible to the Mode it was in, with the exact settings that were in place, when the save occurred. The Mode settings in each state file include the settings that are affected by Mode Preset, as well as the additional settings affected by Restore Mode Defaults; all of the Mode's settings. In addition, all of the settings of the **Input/Output** system are included, even though they are outside of the Mode's state, because they are needed to restore the complete setup. Persistent System settings (for example, GPIB address) are not affected by either a Mode Preset or Restore Mode Defaults, nor are they included in a saved State file.

Since each state file is only for one Mode, the settings for other Modes are unaffected when it is loaded. **Recall State** will cause a mode switch if the state being recalled is not from the current active mode.

After the recall completes, the message "File <filename> recalled" or "Recalled State Register <register number>" is displayed.

For rapid recalls, the State menu lists 16 registers that you can choose from to recall. Pressing a Register key initiates the recall. You can also select a file from which to recall.

The default path for all State Files is:

My Documents\<<mode name>\state

where <mode name> is the parameter used to select the mode with the INST:SEL command (for example, SA for the Spectrum Analyzer).

See ["More Information" on page 208](#).

Key Path:	Recall
Mode:	All
Remote Command:	:MMEMory:LOAD:STATe <filename>
Example:	:MMEM:LOAD:STAT "myState.state" This recalls the file myState.state on the default path
Example:	MMEM:LOAD:STAT "MyStateFile.state" This loads the state file data (on the default file directory path) into the instrument state.

System Functions
Recall

Notes:	<p>When you pick a file to recall, the analyzer first verifies that the file is recallable in the current instrument by checking the software version and model number of the instrument. If everything matches, a full recall proceeds by aborting the currently running measurement, clearing any pending operations, and then loading the State from the saved state file. You can open state files from any mode, so recalling a State file switches to the mode that was active when the save occurred. After switching to the mode of the saved state file, mode settings and data (if any for the mode) are loaded with values from the saved file. The saved measurement of the mode becomes the newly active measurement and the data relevant to the measurement (if there is any) is recalled.</p> <p>If there is a mismatch between file version or model number or instrument version or model number, the recall function tries to recall as much as possible and returns a warning message. It may limit settings that differ based on model number, licensing or version number.</p> <p>After recalling the state, the Recall State function does the following:</p> <p>Makes the saved measurement for the mode the active measurement.</p> <p>Clears the input and output buffers.</p> <p>Status Byte is set to 0.</p> <p>Executes a *CLS</p> <p>If the file specified is empty an error is generated. If the specified file does not exist, another error is generated. If there is a mismatch between the file and the proper file type, an error is generated. If there is a mismatch between file version or model number or instrument version or model number, a warning is displayed. Then it returns to the State menu and File Open dialog goes away.</p> <p>After the Recall, the analyzer exits the Recall menu and returns to the previous menu.</p>
Backwards Compatibility SCPI:	<p>:MMEMory:LOAD:STATe 1,<filename></p> <p>For backwards compatibility, the above syntax is supported. The "1" is simply ignored.</p>
Initial S/W Revision:	Prior to A.02.00
Help Map ID:	2638

More Information

In measurements that support saving Traces, for example, Swept SA, the Trace data is saved along with the State in the State file. When recalling the State, the Trace data is recalled as well. Traces are recalled exactly as they were stored, including the writing mode and update and display modes. If a Trace was updating and visible when the State was saved, it will come back updating and visible, and its data will be rewritten right away. When you use State to save and recall traces, any trace whose data must be preserved should be placed in View or Blank mode before saving.

The following table describes the Trace Save and Recall possibilities:

<p>You want to recall state and one trace's data, leaving other traces unaffected.</p>	<p>Save Trace+State from 1 trace. Make sure that no other traces are updating (they should all be in View or Blank mode) when the save is performed.</p>	<p>On Recall, specify the trace you want to load the one trace's data into. This trace will load in View. All other traces' data will be unaffected, although their trace mode will be as it was when the state save was performed.</p>
<p>You want to recall all traces</p>	<p>Save Trace+State from ALL traces.</p>	<p>On Recall, all traces will come back in View (or Blank if they were in Blank or Background when saved)</p>
<p>You want all traces to load exactly as they were when saved.</p>	<p>Save State</p>	<p>On recall, all traces' mode and data will be exactly as they were when saved. Any traces that were updating will have their data immediately overwritten.</p>

From File...

When you press "From File", the analyzer brings up a Windows dialog and a menu entitled "**File Open.**" This menu allows you to navigate to the various fields in the Windows dialog without using a keyboard or mouse. The **Tab** and **Arrow** keys can also be used for dialog navigation.

System Functions

Recall



Listed below are the functions of the various fields in the dialog, and the corresponding softkeys:

Open

Performs the recall of the specified file. While the recall is being performed, the floppy icon appears briefly in the Meas bar.

File/Folder List

Enables you to navigate to the center of the dialog that contains the list of files and folders. Once here you can get information about the file and use the tab keys to navigate to the other fields in the dialog, such as Look In.

Look In

The **Look In** field shows the path from which the file will be recalled and allows you to change the path using the up and down arrow keys to navigate to other paths; the Enter key to open a directory; and the Backspace key to go back one directory. The **Look In field** first uses the last path from the Save As dialog **Save In:** path for that same file type. There is no softkey for directly navigating to the Look In field, but you can use the left tab to get here from the File/Folder List.

User specified paths are remembered when you leave and return to a Mode and are reset back to the default using **Restore Mode Defaults**.

Sort

Accesses a menu that enables you to sort the files within the File Open dialog. Only one sorting type can

be selected at a time and the sorting happens immediately. The sorting types are **By Date**, **By Name**, **By extension**, and **By Size**.

Files of Type

This field shows the file suffix for the type of file you have selected to recall. For example, if you navigated here while recalling State, "Mode state (*.state)" is in the field. If you navigated here while recalling Trace, "Mode state (*.trace)" is in the field. If you navigated here while importing a trace data file, "Trace Data (*.csv)" is in the field. For some file types, there is more than one choice in the dropdown menu, which you can select by using the up and down arrow keys and Enter.

Up One Level

This key corresponds to the icon of a folder with the up arrow that is in the tool bar of the dialog. When pressed, it causes the file and folder list to navigate up one level in the directory structure. The Backspace key does the same thing.

Cancel

This key corresponds to the **Cancel** selection in the dialog. It causes the current **Open** request to be cancelled. The ESC key does the same thing.

Key Path:	Recall, State
Notes:	Brings up the Open dialog for recalling a State Save Type
Initial S/W Revision:	Prior to A.02.00
Help Map ID:	2646

Edit Register Names

You may enter a custom name on any of the Register keys, to help you remember what you are using that state to save. To do this, press the **Edit Register Names** key, choose the register whose name you wish to edit, and then enter the desired label using the Alpha Editor or an external PC keyboard.

The maximum number of characters that can be added is 30. In most cases, 30 characters will fit on two lines of the key.

For more information and the SCPI command, see Edit Register Names under the **Save, State** function.

Key Path:	Recall, State
Mode:	All
Dependencies:	N9060A-7FP or N9060B-2FP license required to edit the register names. When the feature is not licensed, sending the SCPI command generates an error, -221, "Settings conflict;Option not available"
Initial S/W Revision:	A.11.00
Help Map ID:	50008

Register 1 thru Register 16

Selecting any one of these register keys causes the State of the mode from the specified Register to be

System Functions

Recall

recalled. Each of the register keys annotates whether it is empty or at what date and time it was last modified. In addition, you can use the **Edit Register Names** key under **Save, State** to enter custom names for each register.

Registers are shared by all modes, so recalling from any one of the registers will cause a mode switch to the mode that was active when the save to the Register occurred.

Although these 16 registers are the only registers available from the front panel, there are 128 state registers available in the instrument. Registers 17–128 are only available from the SCPI interface, using the *RCL command.

After the recall completes, the message "Register <register number> recalled" appears in the message bar. If you are in the Spectrum Analyzer Mode, and you are recalling a register that was saved in the Spectrum Analyzer Mode, then after the recall, you will still be in the Recall Register menu. If the Recall causes you to switch modes, then after the Recall, you will be in the Frequency menu.

If a requested register is empty an error is generated.

Key Path:	Recall, State
Example:	*RCL 1
Range:	1–16 from front panel, 1–128 from SCPI
Readback:	Date and time with seconds resolution are displayed on the key OR A custom name of up to 30 characters entered using the Save, State, Edit Register Names key OR “(empty)” if no prior save operation has been performed to this register.
Initial S/W Revision:	Prior to A.02.00
Modified at S/W Revision:	Prior to A.11.00
Help Map ID:	2639

Trace (+State)

The Recall Trace (+State) menu lets you choose a register or file from which to recall the Trace+State state file.

A saved state contains all of the settings and data required to return the analyzer as closely as possible to the exact setup it had when the save occurred. This includes the Input/Output settings, even though they are outside of the Mode’s state, because they are needed to restore the complete setup. A Trace+State file also includes trace data from one trace or all traces, which will load in View mode when the Trace+State file is recalled. Recall Trace (+State) will also cause a mode switch if the state being recalled is not for the current active mode.

After the recall completes, the message "File <filename> recalled" or “Recalled Trace Register <register number>” is displayed.

For rapid recalls, the Trace (+State) menu lists 5 registers to choose from to recall. Pressing a Register

key initiates the recall. You can also select a file from which to recall.

The default path for all State Files including .trace files is:

My Documents\<<mode name>\state

where <mode name> is the parameter used to select the mode with the INST:SEL command (for example, SA for the Spectrum Analyzer).

Key Path:	Recall
Mode:	SA
Remote Command:	:MMEMory:LOAD:TRACe TRACE1 TRACE2 TRACE3 TRACE4 TRACE5 TRACE6 , <filename> :MMEMory:LOAD:TRACe:REGister TRACE1 TRACE2 TRACE3 TRACE4 TRACE5 TRACE6 , <integer>
Example:	MMEM:LOAD:TRAC TRACE2,"MyTraceFile.trace" This loads the trace file data (on the default file directory path) into the specified trace; if it is a "single trace" save file, that trace is loaded to trace 2, and is set to be not updating. :MMEM:LOAD:TRAC:REG TRACE1,2 restores the trace data in register 2 to Trace 1
Notes:	When you perform the recall, the recalling Trace function must first verify the file is recallable in this instrument by checking instrument software version and model number, since it includes State. If everything matches, a full recall proceeds by aborting the currently running measurement, and loading the state from the saved state file to as close as possible to the context in which the save occurred. You can open .trace files from any mode that supports them, so recalling a Trace file switches to the mode that was active when the save occurred. After switching to the mode of the saved state file, mode settings and data (if any for the mode) are loaded with values from the saved file and the saved measurement of the mode becomes the newly active measurement, and the data relevant to the measurement (if there is any) is recalled. Once the state is loaded, the trace data must be loaded. The internal flags are consulted to see which trace to load and the "To Trace" setting to see where to load it. Trace data is always loaded with the specified trace set to View, so that the data is visible and not updating(so as not to erase the recalled data). If the file is an "all trace" file, all traces are loaded with the saved data(to the original trace the data was saved from) and set to View. Traces whose data is not loaded are restored to the update state that existed when they were saved. After the Recall the analyzer exits the Recall menu and returns to the previous menu. Some modes and measurements do not have available all 6 traces. Phase Noise mode command, for example, is: MMEMory:LOAD:TRACe TRACE1 TRACE2 TRACE3 , <filename>
Initial S/W Revision:	Prior to A.02.00
Help Map ID:	3491

Register 1 thru Register 5

Selecting any one of these register keys causes the Traces and State from the specified Register to be recalled. Each of the register keys annotates whether it is empty or at what date and time it was last modified.

Trace registers are shared by all modes, so recalling from any one of the 5 registers may cause a mode switch to the mode that was active when the save to the Register occurred.

Key Path:	Recall, Trace
Range:	1-5
Readback:	Date and time with seconds resolution of the last Save is displayed on the key, or "(empty)" if no prior save operation performed to this register.
Initial S/W Revision:	Prior to A.02.00
Help Map ID:	3593

To Trace

These menu selections let you choose the Trace where the recalled saved trace will go. Not all modes have the full 6 traces available. The default is the currently selected trace, selected in this menu or in the Trace/Detector, Export Data, Import Data, or Save Trace menus, except if you have chosen All, then it remains chosen until you specifically change it to a single trace.

If the .trace file is an "all trace" file, "**To Trace**" is ignored and the traces each go back to the trace from which they were saved.

Once selected, the key returns back to the Recall Trace menu and the selected Trace number is annotated on the key. Now you have selected exactly where the trace needs to be recalled. To trigger a recall of the selected Trace, you must select the **Open** key in the Recall Trace menu.

When you select a trace, it makes that trace the current trace, so it displays on top of all of the other traces.

Key Path:	Save, Data, Trace
Mode:	SA
Initial S/W Revision:	Prior to A.02.00
Help Map ID:	3492

From File...

When you press "From File", the analyzer brings up a Windows dialog and a menu entitled "**File Open.**" This menu allows you to navigate to the various fields in the Windows dialog without using a keyboard or mouse. The **Tab** and **Arrow** keys can also be used for dialog navigation.

See "[From File...](#)" on page 209 under Save, State for a full description of this dialog and menu.

Key Path:	Recall, Trace
-----------	----------------------

Mode:	SA
Notes:	Brings up Open dialog for recalling a Trace Save Type
Initial S/W Revision:	Prior to A.02.00
Help Map ID:	3493

Sequences

This menu and all of its submenus are only available in the EXT (E6607A).

These keys allow you to import a Tab separated or .txt file that will automatically setup all the parameters required for building a Sequence. The parameters will automatically be loaded into the Stated Sequencer.

Once selected, in order to import the selected Sequence Type you must select the Open key in the Source Sequence menu.

Key Path:	Recall, Sequences
Mode:	All
Remote Command:	:MMEMory:LOAD:SEQuences: SLIS ALIS SAALIS "MySequence.txt"
Example:	:MMEM:LOAD:SEQ:SLIS "MySequence.txt"
Notes:	Available file types are: CSV (Comma delimited) (*.csv) Text (Tab delimited) (*.txt)
Initial S/W Revision:	A.05.00
Help Map ID:	3630

Source Sequence

The list of parameters, that configure steps, that makes up a sequence for the Source.

The Source sequence is a sequence of flexible configurable steps that can be set anywhere in the instruments frequency range.

Key Path:	Recall, Sequences
Example:	:MMEM:LOAD:SEQ:SLIS "MySequence.txt"
Dependencies:	Only available in XOBT
Initial S/W Revision:	A.05.00
Help Map ID:	3631

Analyzer Sequence

Only Available in: Sequence Analyzer Mode

The list of parameters, that configure steps, that makes up a sequence for the Analyzer.

The Analyzer sequence is a sequence of flexible configurable steps that can be set anywhere in the instruments frequency range for measuring the performance of a transmitters output

Key Path:	Recall,Sequences
Example:	:MMEM:LOAD:SEQ:ALIS "MySequence.txt"
Dependencies:	Only available in XOBT, Sequence Analyzer mode
Initial S/W Revision:	A.05.00
Help Map ID:	3632

Source and Analyzer Sequence

Only Available in: Sequence Analyzer Mode

The list of parameters, that configure steps, that makes up sequences for the Analyzer and the Source.

The Source and Analyzer sequence is completely configurable and can have internal triggers between the source and the analyzer to orchestrate a sequence to completely test an external transmitter and receiver's performance.

Key Path:	Recall,Sequences
Example:	:MMEM:LOAD:SEQ:SAAL "MySequence.txt"
Dependencies:	Only available in XOBT, Sequence Analyzer mode
Initial S/W Revision:	A.05.00
Help Map ID:	3633

Open...

Pressing **File Open** brings up the File Open standard Windows dialog and the File Open key menu. When the user navigates to this selection, they have already determined they are recalling a specific Data Type and now they want to specify which file to open.

When you first enter this dialog, the path is in the Look In: field in this File Open dialog depends on which import data type you navigated here from.

The only files that are visible are those specific to the file type being recalled.

Key Path:	Recall, Sequence
Notes:	The key location is mode-dependent and will vary.
Notes:	Brings up Open dialog for recalling a <sequence> Save Type
Initial S/W Revision:	A.05.00

Help Map ID:	3635
--------------	------

Data (Import)

Importing a data file loads data that was previously saved from the current measurement or from other measurements and/or modes that produce compatible data files. The Import Menu only contains Data Types that are supported by the current measurement.

Since the commonly exported data files are in .csv format, the data can be edited by the user prior to importing. This allows you to export a data file, manipulate the data in Excel (the most common PC Application for manipulating .csv files) and then import it.

Importing Data loads measurement data from the specified file into the specified or default destination, depending on the data type selected. Selecting an Import Data menu key will not actually cause the importing to occur, since the analyzer still needs to know from where to get the data. Pressing the Open key in this menu brings up the Open dialog and Open menu that provides you with the options from where to recall the data. Once a filename has been selected or entered in the Open menu, the recall occurs as soon as the Open button is pressed.

Key Path:	Recall
Mode:	All
Notes:	The menu is built from whatever data types are available for the mode. Some keys will be missing completely, so the key locations in the sub-menu will vary. No SCPI command directly controls the Data Type that this key controls. The Data Type is included in the MMEM:LOAD commands.
Dependencies:	If a file type is not used by a certain measurement, it is grayed out for that measurement. The key for a file type will not show at all if there are no measurements in the Mode that support it.
Preset:	Is not affected by Preset or shutdown, but is reset during Restore Mode Defaults
Readback:	The data type that is currently selected
Initial S/W Revision:	Prior to A.02.00
Help Map ID:	2648

Open...

When you press “Open”, the analyzer brings up a Windows dialog and a menu entitled “**File Open.**” This menu allows you to navigate to the various fields in the Windows dialog without using a keyboard or mouse. The **Tab** and **Arrow** keys can also be used for dialog navigation.

See “[From File...](#)” on page 209 in **Recall, State**, for a full description of this dialog and menu.

Key Path:	Recall, Data
-----------	---------------------

System Functions
Recall

Notes:	The key location is mode-dependent and will vary. Brings up Open dialog for recalling a <mode specific> Save Type
Initial S/W Revision:	Prior to A.02.00
Help Map ID:	2654

Save

The **Save** menu lets you choose what you want to save and where you want to save it. Among the types of files you can save are **States**, **Traces**, and **Screen Images**. In addition, an **Export (Data)** option lets you save a number of data types as CSV files for easy import into Excel and other spreadsheet programs.

Key Path:	Front-panel key
Mode:	All
Notes:	No remote command for this key specifically, but the :MMEM:STORe command is available for specific file types. An example is :MMEM:STOR:STATe <filename>.
Initial S/W Revision:	Prior to A.02.00
Help Map ID:	2600

State

The Save State menu lets you choose a register or file for saving the state.

The content of a state file includes all of the settings and data required to return the analyzer as closely as possible to the Mode it was in, with the exact settings which were in place, when the save occurred. The Mode settings in each state file include the settings that are affected by Mode Preset, as well as the additional settings affected by Restore Mode Defaults; all of the Mode's settings. In addition, all of the settings of the **Input/Output** system are included, even though they are outside of the Mode's state, because they are needed to restore the complete setup. Persistent **System** settings (for example, GPIB address) are not affected by either Mode Preset or Restore Mode Defaults, nor are they included in a saved State file.

After the save completes, the message "File <filename> saved" or "State Register <register number> saved" is displayed.

For rapid saving, the State menu lists 16 registers to save to. Pressing a Register key initiates the save. You can also select a file to save to.

The default path for all State Files is:

My Documents\<mode name>\state

where <mode name> is the parameter used to select the mode with the INST:SEL command (for example, SA for the Spectrum Analyzer).

Key Path:	Save
Mode:	All
Remote Command:	:MMEMory:STORe:STATe <filename>

System Functions
Save

Example:	MMEM:STOR:STATe "MyStateFile.state" This stores the current instrument state data in the file MyStateFile.state in the default directory.
Notes:	Both single and double quotes are supported for any filename parameter over remote. After saving to a register, that register's menu key is updated with the date the time, unless a custom label has been entered for that key. After saving to a register, you remain in the Save State menu, so that you can see the Register key update. After saving to a file, the analyzer automatically returns to the previous menu and any Save As dialog goes away.
Backwards Compatibility SCPI:	:MMEMory:STORe:STATe 1,<filename> For backwards compatibility, the above syntax is supported. The "1" is simply ignored. The command is sequential.
Initial S/W Revision:	Prior to A.02.00
Help Map ID:	2601

To File . . .

When you press "To File", the analyzer brings up a Windows dialog and a menu entitled "Save As." This menu allows you to navigate to the various fields in the Windows dialog without using a keyboard or mouse. The **Tab** and **Arrow** keys can also be used for dialog navigation.

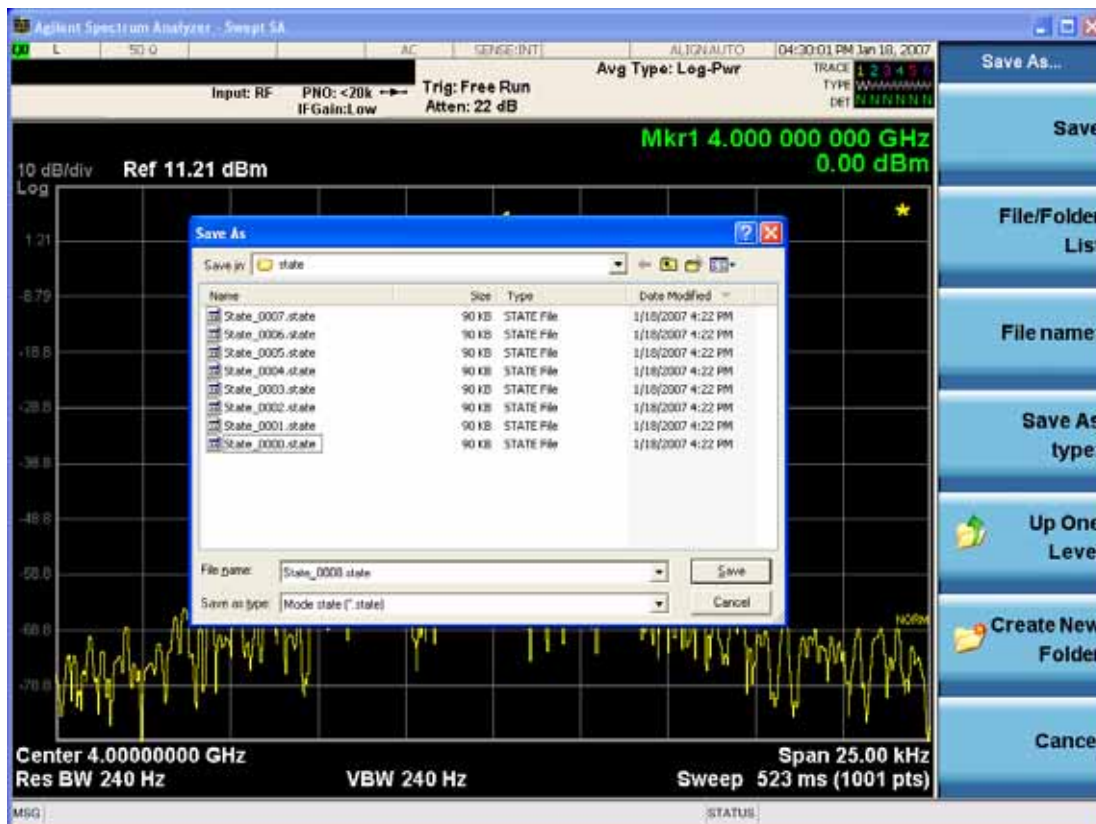

The

Listed below are the functions of the various fields in the dialog, and the corresponding softkeys:

Save

Performs the save to the specified file of the selected type. If the file already exists, a dialog will appear that allows you to replace the existing file by selecting **OK**, or you can Cancel the request. If you select **OK**, the file will be overwritten. Using the C: drive is strongly discouraged, since it runs the risk of being overwritten during an instrument software upgrade.

While the save is being performed, the floppy icon appears briefly in the Meas bar.

File/Folder List

Enables you to navigate to the center of the dialog that contains the list of files and folders. Once here you can get information about the file and use the tab keys to navigate to the other fields in the dialog, such as Save In.

Save In

The Save In field shows the path to which the file will be saved and allows you to change the path using the up and down arrow keys to navigate to other paths; the Enter key to open a directory; and the Backspace key to go back one directory. The **Save In field** defaults to the default path for this type of file and remembers the last path you used to save this type of file. There is no softkey for directly navigating to the Save In field but you can use left tab to get here from the File/Folder List.

User specified paths are remembered when you leave and return to a Mode and are reset back to the default using **Restore Mode Defaults**.

File Name

The **File Name** field is initially loaded with an automatically generated filename specific to the appropriate Save Type. The automatically generated filename is guaranteed not to conflict with any filename currently in the directory. You may replace or modify this filename using the File Name key. See the [“Quick Save” on page 204](#) documentation for more on the automatic file naming algorithm.

When you press the **File Name** key the analyzer displays the Alpha Editor. Use the knob to choose the letter to add and the front-panel Enter key to add the letter to the file name. The BK character moves you back and the FW character moves you forward in the filename. The Select key on the front panel generates a space character. When you are done entering the filename press the **Done** softkey. This returns back to the **File Open** dialog and menu, but does not cause the save to occur.

Save As Type

This field shows the file suffix for the type of file you have selected to save. For example, if you navigated here while saving State, "Mode state (*.state)" is in the field. If you navigated here from saving Trace, "Mode state (*.trace)" is in the field. If you navigated here while exporting a trace data file, "Trace Data (*.csv)" is in the field. For some file types, there is more than one choice in the dropdown, which you can select by using the up and down arrow keys and Enter.

Up One Level

This key corresponds to the icon of a folder with the up arrow that is in the tool bar of the dialog. When pressed, it causes the file and folder list to navigate up one level in the directory structure. The Backspace key does the same thing.

Create New Folder

System Functions

Save

This key corresponds to the icon of a folder with the "*" that is in the tool bar of the dialog. When pressed, a new folder is created in the current directory with the name **New Folder** and you can enter a new folder name using the Alpha Editor.

Cancel

This key corresponds to the **Cancel** selection in the dialog. It causes the current **Save As** request to be cancelled. The ESC key does the same thing.

Key Path:	Save, State
Mode:	All
Notes:	Brings up Save As dialog for saving a State Save Type
Initial S/W Revision:	Prior to A.02.00
Help Map ID:	2609

Edit Register Names

You may enter a custom name on any of the Register keys, to help you remember what you are using that state to save. To do this, press the **Edit Register Names** key, choose the register whose name you wish to edit, and then enter the desired label using the Alpha Editor or an external PC keyboard.

The maximum number of characters that can be added is 30. In most cases, 30 characters will fit on two lines of the key.

See ["More Information" on page 223](#)

Key Path:	Save, State
Mode:	All
Remote Command:	:MMEMory:REGister:STATe:LABel <reg number>,"label" :MMEMory:REGister:STATe:LABel? <reg number>
Example:	:MMEM:REG:STAT:LAB 1,"my label"
Notes:	<reg number> is an integer from 1 to 16. If the SCPI specifies an invalid register number an error message is generated, -222,"Data out of range;Invalid register label number" "label" is a string from 0 to 30 characters in length. If a label exceeds 30 characters, an error message is generated, -150,"String data error;Label clipped to 30 characters" "label" of length 0 erases the custom label and restores the default (time and date) label. E.g.: :MMEM:REG:STAT:LAB 1,""
Dependencies:	N9060A-7FP or N9060B-2FP license required to edit the register names. When the feature is not licensed, sending this command generates an error, -221,"Settings conflict;Option not available"
Preset:	The names are unaffected by Preset or power cycle but are set to the default label (time and date) on a "Restore System Defaults->Misc"

Initial S/W Revision:	A.11.00
Help Map ID:	50009

More Information

When you edit one of the register names, the time and date field will be replaced by the custom name.

If you delete all the characters in the custom name, it restores the default (time and date).

The register names are stored within the state files, but they are not part of the instrument state; that is, once you have edited a register name, loading a new state will not change that register name. Another consequence of this is that the names will be persistent through a power cycle. Also, if a named state file is transferred to another analyzer, it will bring its custom name along with it.

If you try to edit the name of an empty register, the analyzer will first save the state to have a file to put the name in. If you load a named state file into an analyzer with older firmware it will ignore the metadata.

The *SAV and *RCL commands will not be affected by the custom register names, nor will the MMEM commands.

Register 1 thru Register 16

Selecting any one of these register menu keys causes the State of the currently active mode to be saved to the specified Register. The registers are provided for rapid saving and recalling, since you do not need to specify a filename or navigate to a file. Each of the register menu keys annotates whether it is empty or at what date and time it was last modified. In addition, you can use the **Edit Register Names** key to enter custom names for each register.

Although these 16 registers are the only registers available from the front panel, there are 128 state registers available in the instrument. Registers 17–128 are only available from the SCPI interface, using the *SAV command.

There is one set of 128 state registers in the instrument, not one set for each Mode. When a state is saved, the Mode it was saved from is saved with it; then when it is recalled, the instrument switches to that Mode.

After the save completes, the corresponding register menu key annotation is updated with the date and time and the message "Register <register number> saved" is displayed.

Key Path:	Save, State
Mode:	All
Example:	*SAV 1
Range:	1–16 from front panel, 1–128 from SCPI

System Functions
Save

Readback:	Date and time with seconds resolution are displayed on the key OR A custom name of up to 30 characters entered using the Edit Register Names key OR “(empty)” if no prior save operation has been performed to this register.
Initial S/W Revision:	Prior to A.02.00
Modified at S/W Revision:	A.11.00
Help Map ID:	2602

Trace (+State)

The **Save Trace (+State)** menu lets you choose a register or file specifying where to save the Trace+State state file.

A saved state contains all of the settings and data required to return the analyzer as closely as possible to the exact setup it had when the save occurred. This includes the Input/Output settings, even though they are outside of the Mode’s state, because they are needed to restore the complete setup. A Trace+State file also includes trace data from one trace or all traces, which will load in View mode when the Trace+State file is recalled.

After the save completes, the message "File <filename> saved" or "Trace Register <register number> saved" is displayed.

For rapid saves, the Trace (+State) menu lists 5 registers to save to. Pressing a Register key initiates the save. You can also select a file to save to.

The default path for all State Files including .trace files is:

My Documents\<mode name>\state

where <mode name> is the parameter used to select the mode with the INST:SEL command (for example, SA for the Spectrum Analyzer).

This key is grayed out for measurements that do not support trace saves. It is blanked for modes that do not support trace saves. Saving **Trace** is identical to saving State except a .trace extension is used on the file instead of .state, and internal flags are set in the file indicating which trace was saved. You may select to save one trace or ALL traces.

Key Path:	Save
Mode:	SA
Remote Command:	:MMEMory:STORe:TRACe TRACE1 TRACE2 TRACE3 TRACE4 TRACE5 TRACE6 ALL, <filename> > :MMEMory:STORe:TRACe:REGister TRACE1 TRACE2 TRACE3 TRACE4 TRACE5 TRACE6 ALL, <integer>

Example:	<p>:MMEM:STOR:TRAC TRACE1,“myState.trace” saves the file myState.trace on the default path and flags it as a “single trace” file with Trace 1 as the single trace (even though all of the traces are in fact stored).</p> <p>:MMEM:STOR:TRAC ALL,“myState.trace” saves the file myState.trace on the default path and flags it as an “all traces” file</p> <p>:MMEM:STOR:TRAC:REG TRACE1,2 stores trace 1 data in trace register 2</p>
Notes:	<p>This command actually performs a save state, which in the Swept SA measurement includes the trace data. However it flags it (in the file) as a “save trace” file of the specified trace (or all traces).</p> <p>Some modes and measurements do not have available all 6 traces. The Phase Noise mode command, for example, is: MMEMory:STORe:TRACe TRACE1 TRACE2 TRACE3 ALL,<filename></p> <p>The range for the register parameter is 1–5</p> <p>When you initiate a save, if the file already exists, a dialog will appear that allows you to replace the existing file by selecting OK or you can Cancel the request. If you select OK, the file will be overwritten. Using the C: drive is strongly discouraged, since it runs the risk of being overwritten during an instrument software upgrade.</p> <p>Both single and double quotes are supported for any filename parameter over remote.</p> <p>After saving to a register, that register’s menu key is updated with the date and time of the save.</p> <p>After saving to a register, you remain in the Save Trace menu, so that you can see the Register key update. After saving to a file, the analyzer automatically returns to the previous menu and any Save As dialog goes away.</p>
Initial S/W Revision:	Prior to A.02.00
Help Map ID:	3486

Register 1 thru Register 5

Selecting any one of these register menu keys causes the Trace(s) specified under From Trace, along with the state of the currently active mode, to be saved to the specified Trace Register. The registers are provided for rapid saving and recalling, since you do not need to specify a filename or navigate to a file. Each of the register menu keys annotates whether it is empty or at what date and time it was last modified.

Key Path:	Save, Trace
Mode:	SA
Range:	1–5
Readback:	Date and time with seconds resolution are displayed on the key, or "(empty)" if no prior save operation performed to this register.
Initial S/W Revision:	Prior to A.02.00

Help Map ID:	3598
--------------	------

From Trace

Accesses a menu that enables you to select the trace to be saved. Once a trace is selected, the key returns to the Save Trace menu and the selected trace number is annotated on the key. The default is the currently selected trace, selected in this menu or in the Trace/Det, Export Data, Import Data or Recall Trace menus, except if you have chosen All then it remains chosen until you specifically change it to a single trace. To save the Trace you must select the **Save As** key in the Save Trace menu.

When you select a trace, it makes that trace the current trace, so it displays on top of all of the other traces.

Key Path:	Save, Trace + State
Mode:	SA
Initial S/W Revision:	Prior to A.02.00
Help Map ID:	3505

To File . . .

When you press “To File”, the analyzer brings up a Windows dialog and a menu entitled “**Save As.**” This menu allows you to navigate to the various fields in the Windows dialog without using a keyboard or mouse. The **Tab** and **Arrow** keys can also be used for dialog navigation.

See “[To File . . .](#)” on page 220 in **Save, State** for a full description of this dialog and menu.

Key Path:	Save, Trace (+State)
Mode:	SA
Notes:	Brings up Save As dialog for saving a Trace+State Save Type
Initial S/W Revision:	Prior to A.02.00
Help Map ID:	3506

Sequences

This menu and all of its submenus are only available in the EXT (E6607A).

These keys allow you to save a Tab separated or CSV file of the setup parameters required to build a Sequence.

In order to save you must select the Save As button and choose a destination folder.

Key Path:	Save, Sequences
Mode:	All
Remote Command:	:MMEM:STOR:SEquences: SLIST ALIST SAAList SSTep "MySequence.txt"

Example:	:MMEM:STOR:SEQ:SLIS "MySequence.txt"
Notes:	Available file types are: CSV (Comma delimited) (*.csv) Text (Tab delimited) (*.txt)
Initial S/W Revision:	A.05.00
Help Map ID:	3636

Source Sequence

The list of parameters, that configure steps, that makes up a sequence for the Source.

The Source sequence is a sequence of flexible configurable steps that can be set anywhere in the instruments frequency range.

Key Path:	Save, Sequences
Example:	:MMEM:STOR:SEQ:SLIS "MySequence.txt"
Dependencies:	Only available in XOBT
Initial S/W Revision:	A.05.00
Help Map ID:	3637

Analyzer Sequence

Only Available in: Sequence Analyzer Mode

The list of parameters, that configure steps, that makes up a sequence for the Analyzer.

The Analyzer sequence is a sequence of flexible configurable steps that can be set anywhere in the instruments frequency range for measuring the performance of a transmitters output

Key Path:	Save, Sequences
Example:	:MMEM:STOR:SEQ:ALIS "MySequence.txt"
Dependencies:	Only available in XOBT, Sequence Analyzer mode
Initial S/W Revision:	A.05.00
Help Map ID:	3638

Source and Analyzer Sequence

Available in: Sequence Analyzer Mode

The list of parameters, that configure steps, that makes up a sequence for the Analyzer and the Source.

The Source and Analyzer sequence is completely configurable and can have internal triggers between the source and the analyzer to orchestrate a sequence to completely test an external transmitter and

System Functions

Save

receiver's performance.

Key Path:	Save, Sequences
Example:	:MMEM:STOR:SEQ:SAAL "MySequence.txt"
Dependencies:	Only available in XOBT, Sequence Analyzer mode
Initial S/W Revision:	A.05.00
Help Map ID:	3639

Save As . . .

This menu lets you select the location where you can save the Sequence. This menu is a standard Windows® dialog with Save As menu keys. The "File Name" field in the Save As dialog is initially loaded with an automatically generated filename specific to the appropriate Save Type. The automatically generated filename is guaranteed not to conflict with any filename currently in the directory. You may replace or modify this filename using the File Name softkey. See the Quick Save key documentation for more on the automatic file naming algorithm.

The default path for all Sequence Files is:

My Documents\Sequences

Key Path:	Save, Sequences
Mode:	All
Notes:	Brings up Save As dialog for saving a Sequence Save Type
Initial S/W Revision:	A.05.00
Help Map ID:	3641

Data (Export)

Exporting a data file stores data from the current measurement to mass storage files. The Export Menu only contains data types that are supported by the current measurement.

Since the commonly exported data files are in .csv format, the data can be edited by you prior to importing. This allows you to export a data file, manipulate the data in Excel (the most common PC Application for manipulating .csv files) and then import it.

Selecting an Export Data menu key will not actually cause the exporting to occur, since the analyzer still needs to know where you wish to save the data. Pressing the Save As key in this menu brings up the Save As dialog and Save As menu that allows you to specify the destination file and directory. Once a filename has been selected or entered in the Open menu, the export will occur as soon as the Save key is pressed.

Key Path:	Save
Mode:	All

Notes:	The menu is built from whatever data types are available for the mode. So the key locations in the sub menu will vary. No SCPI command directly controls the Data Type that this key controls. The Data Type is included in the MMEM:STORe commands.
Dependencies:	If a file type is not used by a certain measurement, that type is grayed out for that measurement. The key for a file type will not show at all if there are no measurements in the Mode that support it.
Preset:	Is not affected by a Preset or shutdown, but is reset during Restore Mode Defaults
Readback:	The data type that is currently selected
Initial S/W Revision:	Prior to A.02.00
Help Map ID:	2611

Save As . . .

When you press “Save As”, the analyzer brings up a Windows dialog and a menu entitled “**Save As.**” This menu allows you to navigate to the various fields in the Windows dialog without using a keyboard or mouse. The **Tab** and **Arrow** keys can also be used for dialog navigation.

See “[To File . . .](#)” on page 220 in **Save, State** for a full description of this dialog and menu.

The default path for saving files is:

For all of the Trace Data Files:

My Documents\<<mode name>\data\traces

For all of the Limit Data Files:

My Documents\<<mode name>\data\limits

For all of the Measurement Results Data Files:

My Documents\<<mode name>\data\<<measurement name>\results

For all of the Capture Buffer Data Files:

My Documents\<<mode name>\data\captureBuffer

Key Path:	Save, Data
Mode:	All
Notes:	The key location is mode-dependent and will vary. Brings up the Save As dialog for saving a <mode specific> Save Type. The save is performed immediately and does not wait until the measurement is complete.
Initial S/W Revision:	Prior to A.02.00
Help Map ID:	2617

Screen Image

Pressing Screen Image accesses a menu of functions that enable you to specify a format and location for the saved screen image. It brings up a menu that allows you to specify the color scheme of the Screen Image (Themes) or navigate to the Save As dialog to perform the actual save.

Screen Image files contain an exact representation of the analyzer display. They cannot be loaded back onto the analyzer, but they can be loaded into your PC for use in many popular applications.

The image to be saved is actually captured when the **Save** front panel key is pressed, and kept in temporary storage to be used if you ask for a Screen Image save. When the Screen Image key is pressed, a "thumbnail" of the captured image is displayed, as shown below:

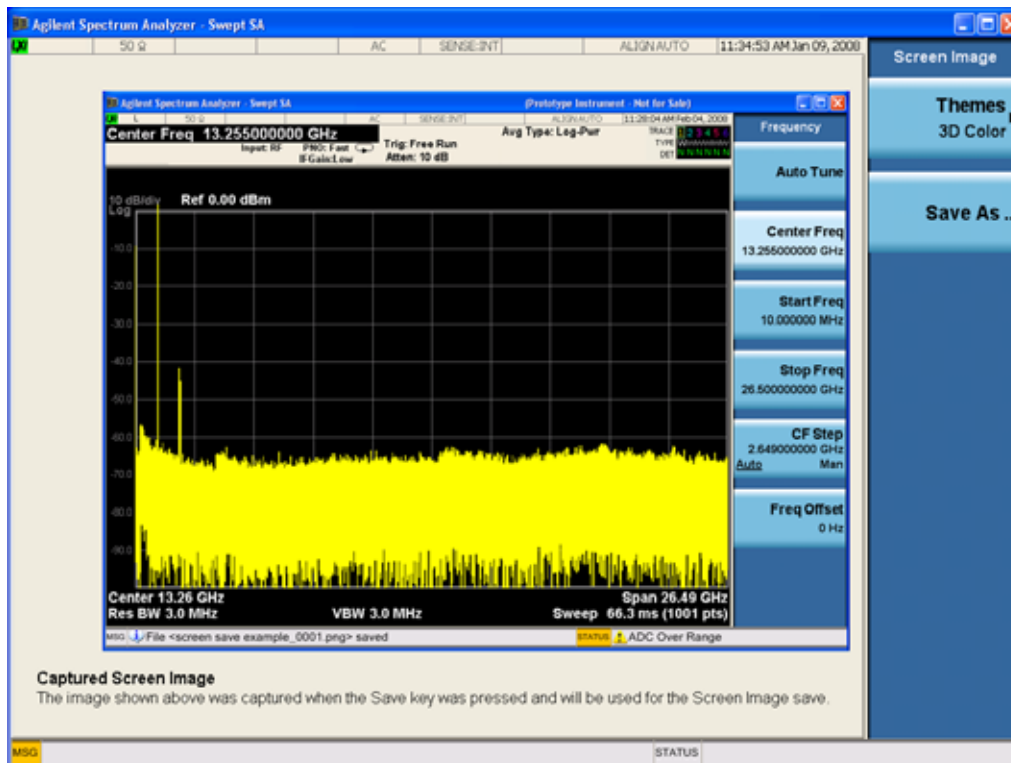

When you continue on into the **Save As** menu and complete the Screen Image save, the image depicted in the thumbnail is the one that gets saved, showing the menus that were on the screen before going into the **Save** menus. The save is performed immediately and does not wait until the measurement is complete.

After you have completed the save, the **Quick Save** front-panel key lets you quickly repeat the last save performed, using an auto-named file, with the current screen data.

NOTE For versions previous to A.01.55, if you initiate a screen image save by navigating through the Save menus, the image that is saved will contain the Save menu softkeys, not the menus and the active function that were on the screen when you first pressed the Save front panel key.

Key Path:	Save
Mode:	All
Remote Command:	:MMEMory:STORe:SCReEn <filename>
Example:	:MMEM:STOR:SCR "myScreen.png" This stores the current screen image in the file MyScreenFile.png in the default directory.
Initial S/W Revision:	Prior to A.02.00
Help Map ID:	2620

Themes

Accesses a menu of functions that enable you to choose the theme to be used when saving the screen image.

The **Themes** option is the same as the **Themes** option under the **Display** and **Page Setup** dialogs. It allows you to choose between themes to be used when saving the screen image.

Key Path:	Save, Screen Image
Remote Command:	:MMEMory:STORe:SCReEn:THEME TDCoLor TDMonochrome FCoLoR FMONochrome :MMEMory:STORe:SCReEn:THEMe?
Example:	:MMEM:STOR:SCR:THEM TDM
Preset:	3D Color; Is not part of Preset, but is reset by Restore Misc Defaults or Restore System Defaults All and survives subsequent running of the modes.
Readback:	3D Color 3D Mono Flat Color Flat Mono
Backwards Compatibility Notes:	In ESA and PSA we offer the choice of "Reverse Bitmap" or "Reverse Metafile" when saving screen images. This is much like the "Flat Color" theme available in X-Series. Also, if the user selected Reverse Bitmap AND a black&white screen image, that would be much like "Flat Monochrome". In other words, each of the X-Series themes has a similar screen image type in ESA/PSA. But they are not identical.
Initial S/W Revision:	Prior to A.02.00
Help Map ID:	2621

3D Color

Selects a standard color theme with each object filled, shaded and colored as designed.

Key Path:	Save, Screen Image, Themes
Example:	MMEM:STOR:SCR:THEM TDC

System Functions
Save

Readback:	3D Color
Initial S/W Revision:	Prior to A.02.00
Help Map ID:	2622

3D Monochrome

Selects a format that is like 3D color but shades of gray are used instead of colors.

Key Path:	Save, Screen Image, Themes
Example:	MMEM:STOR:SCR:THEM TDM
Readback:	3D Mono
Initial S/W Revision:	Prior to A.02.00
Help Map ID:	2623

Flat Color

Selects a format that is best when the screen is to be printed on an ink printer.

Key Path:	Save, Screen Image, Themes
Example:	MMEM:STOR:SCR:THEM FCOL
Readback:	Flat Color
Initial S/W Revision:	Prior to A.02.00
Help Map ID:	2624

Flat Monochrome

Selects a format that is like Flat Color. But only black is used (no colors, not even gray), and no fill.

Key Path:	Save, Screen Image, Themes
Example:	MMEM:STOR:SCR:THEM FMON
Readback:	Flat Mono
Initial S/W Revision:	Prior to A.02.00
Help Map ID:	2625

Save As...

When you press “Save As”, the analyzer brings up a Windows dialog and a menu entitled “**Save As.**” This menu allows you to navigate to the various fields in the Windows dialog without using a keyboard or mouse. The **Tab** and **Arrow** keys can also be used for dialog navigation.

See “[To File . . .](#)” on page 220 in **Save, State** for a full description of this dialog and menu.

The default path for Screen Images is

My Documents\<<mode name>\screen.

where <mode name> is the parameter used to select the mode with the INST:SEL command (for example, SA for the Spectrum Analyzer).

Key Path:	Save, Screen Image
Notes:	Brings up Save As dialog for saving a Screen Image Save Type
Initial S/W Revision:	Prior to A.02.00
Help Map ID:	2626

Mass Storage Catalog (Remote Command Only)

Remote Command:	:MMEMory:CATalog? [<directory_name>]
Notes:	<p>The string must be a valid logical path.</p> <p>Queries disk usage information (drive capacity, free space available) and obtains a list of files and directories in a specified directory in the following format:</p> <p><numeric_value>,<numeric_value>,{<file_entry>}</p> <p>It returns two numeric parameters and as many strings as there are files and directories. The first parameter indicates the total amount of storage currently used in bytes. The second parameter indicates the total amount of storage available, also in bytes. The <file_entry> is a string. Each <file_entry> indicates the name, type, and size of one file in the directory list:</p> <p><file_name>,<file_type>,<file_size></p> <p>As the windows file system has an extension that indicates file type, <file_type> is always empty. <file_size> provides the size of the file in bytes. For directories, <file_entry> is surrounded by square brackets and both <file_type> and <file_size> are empty</p>
Initial S/W Revision:	Prior to A.02.00
Help Map ID:	0

Mass Storage Change Directory (Remote Command Only)

Remote Command:	:MMEMory:CDIRectory [<directory_name>] :MMEMory:CDIRectory?
Notes:	<p>The string must be a valid logical path.</p> <p>Changes the default directory for a mass memory file system. The <directory_name> parameter is a string. If no parameter is specified, the directory is set to the *RST value.</p> <p>At *RST, this value is set to the default user data storage area, that is defined as System.Environment.SpecialFolder.Personal.</p> <p>Query returns full path of the default directory.</p>
Initial S/W Revision:	Prior to A.02.00
Help Map ID:	0

Mass Storage Copy (Remote Command Only)

Remote Command:	:MMEMory:COPY <string>,<string> [, <string>,<string>]
-----------------	---

Notes:	<p>The string must be a valid logical path.</p> <p>Copies an existing file to a new file or an existing directory to a new directory.</p> <p>Two forms of parameters are allowed. The first form has two parameters. In this form, the first parameter specifies the source, and the second parameter specifies the destination.</p> <p>The second form has four parameters. In this form, the first and third parameters specify the source. The second and fourth parameters specify the directories. The first pair of parameters specifies the source. The second pair specifies the destination. An error is generated if the source doesn't exist or the destination file already exists.</p> <p>This command will generate an "access denied" error if the destination is a restricted folder (e.g., C:\Windows) and the current user does not have Power User or Administrator privileges.</p>
Help Map ID:	0

Mass Storage Delete (Remote Command Only)

Remote Command:	:MMEMory:DELeTe <file_name> [, <directory_name>]
Notes:	<p>The string must be a valid logical path.</p> <p>Removes a file from the specified directory. The <file_name> parameter specifies the file name to be removed. This command will generate an "access denied" error if the file is in a restricted folder (e.g., C:\Windows) and the current user does not have Power User or Administrator privileges.</p>
Initial S/W Revision:	Prior to A.02.00
Help Map ID:	0

Mass Storage Data (Remote Command Only)

Creates a file containing the specified data OR queries the data from an existing file.

Remote Command:	:MMEMory:DATA <file_name>, <data> :MMEMory:DATA? <file_name>
Notes:	<p>The string must be a valid logical path.</p> <p>The command form is MMEMory:DATA <file_name>,<data>. It loads <data> into the file <file_name>. <data> is in 488.2 block format. <file_name> is string data.</p> <p>The query form is MMEMory:DATA? <file_name> with the response being the associated <data> in block format.</p>
Initial S/W Revision:	Prior to A.02.00
Help Map ID:	0

Mass Storage Make Directory (Remote Command Only)

Remote Command:	:MMEMory:MDIRectory <directory_name>
Notes:	<p>The string must be a valid logical path.</p> <p>Creates a new directory. The <directory_name> parameter specifies the name to be created.</p> <p>This command will generate an “access denied” error if the new directory would be in a restricted folder (e.g., C:\Windows) and the current user does not have Power User or Administrator privileges.</p>
Initial S/W Revision:	Prior to A.02.00
Help Map ID:	0

Mass Storage Move (Remote Command Only)

Remote Command:	:MMEMory:MOVE <string>, <string> [, <string>, <string>]
Notes:	<p>The string must be a valid logical path.</p> <p>Moves an existing file to a new file or an existing directory to a new directory.</p> <p>Two forms of parameters are allowed. The first form has two parameters. In this form, the first parameter specifies the source, and the second parameter specifies the destination.</p> <p>The second form has four parameters. In this form, the first and third parameters specify the source. The second and fourth parameters specify the directories. The first pair of parameters specifies the source. The second pair specifies the destination. An error is generated if the source doesn't exist or the destination file already exists.</p> <p>This command will generate an “access denied” error if the destination is a restricted folder (e.g., C:\Windows) and the current user does not have Power User or Administrator privileges.</p>
Initial S/W Revision:	Prior to A.02.00
Help Map ID:	0

Mass Storage Remove Directory (Remote Command Only)

Remote Command:	:MEMMory:RDIRectory <directory_name>
Notes:	<p>The string must be a valid logical path.</p> <p>Removes a directory. The <directory_name> parameter specifies the directory name to be removed. All files and directories under the specified directory shall also be removed.</p> <p>This command will generate an “access denied” error if the folder is a restricted folder (e.g., C:\Windows) or is in a restricted folder and the current user does not have Power User or Administrator privileges.</p>

Initial S/W Revision:	Prior to A.02.00
Help Map ID:	0

System

Opens a menu of keys that access various configuration menus and dialogs.

Key Path:	Front-panel key
Notes:	No remote command for this key specifically.
Initial S/W Revision:	Prior to A.02.00
Help Map ID:	2400

Show

Accesses a menu of choices that enable you to select the information window you want to view.

Key Path:	System
Mode:	All
Remote Command:	:SYSTem:SHOW OFF ERRor SYSTem HARDware LXI HWSTatistics ALIGNment SOFTware CAPplication :SYSTem:SHOW?
Example:	:SYST:SHOW SYST
Notes:	This command displays (or exits) the various System information screens.
Preset:	OFF
State Saved:	No
Range:	OFF ERRor SYSTem HARDware LXI HWSTatistics ALIGNment SOFTware CAPplication
Initial S/W Revision:	Prior to A.02.00
Help Map ID:	2403

Errors

There are two modes for the Errors selection, History and Status.

The list of errors displayed in the Errors screen does not automatically refresh. You must press the Refresh key or leave the screen and return to it to refresh it.

History brings up a screen displaying the event log in chronological order, with the newest event at the top. The history queue can hold up to 100 messages (if a message has a repeat count greater than 1 it only counts once against this number of 100). Note that this count bears no relation to the size of the SCPI queue. If the queue extends onto a second page, a scroll bar appears to allow scrolling with a mouse. Time is displayed to the second.

Status brings up a screen summarizing the status conditions currently in effect. Note that the time is

displayed to the second.

The fields on the Errors display are:

Type (unlabeled) - Displays the icon identifying the event or condition as an error or warning.

ID - Displays the error number.

Message - Displays the message text.

Repeat (RPT) - This field shows the number of consecutive instances of the event, uninterrupted by other events. If an event occurs 5 times with no other intervening event, the value of repeat will be 5.

If the value of Repeat is 1 the field does not display. If the value of Repeat is >1, the time and date shown are those of the most recent occurrence. If the value of repeat reaches 999,999 it stops there.

Time - Shows the most recent time (including the date) at which the event occurred.

Key Path:	System, Show
Mode:	All
Remote Command:	:SYSTem:ERRor [:NEXT] ?
Example:	:SYST:ERR?
Notes:	The return string has the format: “<Error Number>,<Error>” Where <Error Number> and <Error> are those shown on the Show Errors screen

Backwards Compatibility Notes:	<p>In some legacy analyzers, the Repeat field shows the number of times the message has repeated since the last time the error queue was cleared. In the X-Series, the Repeat field shows the number of times the error has repeated since the last intervening error. So the count may very well be different than in the past even for identical signal conditions</p> <p>Unlike previous analyzers, in the X-Series all errors are reported through the Message or Status lines and are logged to the event queue. They never appear as text in the graticule area (as they sometimes do in previous analyzers) and they are never displayed in the settings panel at the top of the screen (as they sometimes do, by changing color, in previous analyzers).</p> <p>As a consequence of the above, the user can only see one status condition (the most recently generated) without looking at the queue. In the past, at least in the Spectrum Analyzer, multiple status conditions might display on the right side of the graticule.</p> <p>In general, there is no backwards compatibility specified or guaranteed between the error numbers in the X-Series and those of earlier products. Error, event, and status processing code in customers' software will probably need to be rewritten to work with X-Series.</p> <p>In the legacy analyzers, some conditions report as errors and others simply turn on status bits. Conditions that report as errors often report over and over as long as the condition exists. In the X-series, all conditions report as start and stop events. Consequently, software that repeatedly queries for a condition error until it stops reporting will have to be rewritten for the X-series.</p>
Initial S/W Revision:	Prior to A.02.00
Help Map ID:	3487

Next Page

Next Page and Previous Page menu keys move you between pages of the log, if it fills more than one page. These keys are grayed out in some cases:

If on the last page of the log, the Next Page key is grayed-out

If on the first page of the log, the Previous Page key is grayed-out.

If there is only one page, both keys are grayed out.

Key Path:	System, Show, Errors
Initial S/W Revision:	Prior to A.02.00
Help Map ID:	2671

Previous Page

See [“Next Page”](#) on page 240.

Key Path:	System, Show, Errors
-----------	-----------------------------

Initial S/W Revision:	Prior to A.02.00
Help Map ID:	3629

History

The History and Status keys select the Errors view. The Status key has a second line which shows a number in [square brackets]. This is the number of currently open status items.

Key Path:	System, Show, Errors
Initial S/W Revision:	Prior to A.02.00
Help Map ID:	2672

Status

See “History” on page 241.

Verbose SCPI On/Off

When you turn Verbose SCPI on, additional information is returned when you send the :SYSTem:ERRor? query. The additional information consists of the characters that stimulated the error. This can aid you in debugging your test programs by indicating where in the parsing of a SCPI command the instrument encountered an invalid command or query.

Specifically, with Verbose SCPI on, the SYSTem:ERRor? query is expanded to show the SCPI data received, with the indicator <Err> at the point in the stream that the error occurred.

Verbose SCPI has no effect on the Show Errors screen or front panel Message Line; it only changes the response to the :SYST:ERR? query.

See the example below, where the invalid command “SENS:BOGUS” is sent:

Normal response to :SYST:ERR (using the Telnet window):

```
SCPI> SENS:BOGUS
```

```
SCPI> SYST:ERR?
```

```
-113,"Undefined header"
```

Now after turning on Verbose SCPI:

```
SCPI> SYST:BOGUS
```

```
SCPI> SYST:ERR?
```

```
-113,"Undefined header;SYST:BOGUS<Err>"
```

Key Path:	System, Show, Errors
Mode:	All
Remote Command:	:SYSTem:ERRor:VERBoSe OFF ON 0 1 :SYSTem:ERRor:VERBoSe?

Example:	:SYST:ERR:VERB ON
Preset:	This is unaffected by Preset but is set to OFF on a “Restore System Defaults->Misc”
State Saved:	No
Range:	On Off
Initial S/W Revision:	Prior to A.02.00
Help Map ID:	2673

Input Overload Enable (Remote Command Only)

Input Overload errors are reported using the Input Overload status bit (bit 12 in the Measurement Integrity status register). Input Overloads (for example, ADC Overload errors) can come and go with great frequency, generating many error events (for example, for signals just on the verge of overload), and so are not put into the SCPI error queue by default. Normally the status bit is the only way for detecting these errors remotely.

It is possible to enable Input Overload reporting to the SCPI queue, by issuing the :SYSTem:ERRor:OVERload ON command. To return to the default state, issue the :SYSTem:ERRor:OVERload OFF command. In either case, Input Overloads always set the status bit.

NOTE For versions of firmware before A.10.01, the Input Overload was only a Warning and so was never available in the SCPI queue, although it did set the status bit. For A.10.01 and later, the Input Overload is an error and can be enabled to the SCPI queue using this command.

Key Path:	SCPI only
Remote Command:	:SYSTem:ERRor:OVERload[:STATe] 0 1 OFF ON
Example:	:SYST:ERR:OVER 1 Enable overload errors
Preset:	Set to OFF by Restore Misc Defaults (no Overload errors go to SCPI)
State Saved:	Saved in instrument state.
Initial S/W Revision:	A.10.01
Help Map ID:	0

Refresh

When pressed, refreshes the Show Errors display.

Key Path:	System, Show, Errors
Initial S/W Revision:	Prior to A.02.00
Help Map ID:	2674

Clear Error Queue

This clears all errors in all error queues.

Note the following:

Clear Error Queue does not affect the current status conditions.

Mode Preset does not clear the error queue.

Restore System Defaults will clear all error queues.

*CLS only clears the queue if it is sent remotely and *RST does not affect any error queue.

Switching modes does not affect any error queues.

Key Path:	System, Show, Errors
Initial S/W Revision:	Prior to A.02.00
Help Map ID:	2675

System

The System screen is formatted into three groupings: product descriptive information, options tied to the hardware, and software products:

<Product Name> <Product Description>	
Product Number: N9020A	
Serial Number: US46220924	
Firmware Revision: A.01.01	
Computer Name: <hostname>	
Host ID: N9020A,US44220924	
N9020A-503	Frequency Range to 3.6 GHz
N9020A-PFR	Precision Frequency Reference
N9020A-P03	Preamp 3.6 GHz
N9060A-2FP	Spectrum Analysis Measurement Suite 1.0.0.0
N9073A-1FP	WCDMA 1.0.0.0
N9073A-2FP	WCDMA with HSDPA 1.0.0.0

The Previous Page is grayed-out if the first page of information is presently displayed. The Next Page menu key is grayed-out if the last page is information is presently displayed.

Key Path:	System, Show
Mode:	All
Example:	SYST:SHOW SYST

System Functions

System

Backwards Compatibility Notes:	The hardware statistics that are displayed in the PSA Show System screen have been moved to a dedicated Show Hardware Statistics screen in the Service Menu.
Initial S/W Revision:	Prior to A.02.00
Help Map ID:	2676

Show System contents (Remote Command Only)

A remote command is available to obtain the contents of the Show System screen (the entire contents, not just the currently displayed page).

Remote Command:	:SYSTem:CONFigure[:SYSTem]?
Example:	:SYST:CONF?
Notes:	The output is an IEEE Block format of the Show System contents. Each line is separated with a new-line character.
Initial S/W Revision:	Prior to A.02.00
Help Map ID:	0

Computer System description (Remote Command Only)

A remote command is available to obtain the Computer System description. The Computer System is the operating system and patch level as reported by operating system.

Remote Command:	:SYSTem:CSYSTem?
Example:	:SYST:CSYS?
Notes:	The return value is the Computer System name and service pack level.
Initial S/W Revision:	Prior to A.12.00
Help Map ID:	0

Hardware

The show hardware screen is used to view details of the installed hardware. This information can be used to determine versions of hardware assemblies and field programmable devices, in the advent of future upgrades or potential repair needs.

The screen is formatted into two groupings: product descriptive information and hardware information. The hardware information is listed in a table format:

Hardware Information							
MXA Signal Analyzer							
Product Number: N9020A							
Serial Number: US46220107							
Firmware Revision: A.01.14							
Assembly Name	Part #	Serial #	Mat Rev	Rev	OF Rev	Hw Id	Misc
Analog IF	E441060104	78060200131	003	0	C	15	
YIG Tuned Filter	50877305	11061500550	005	0	A	11	
Digital IF	E441060105	78060100559	003	0	F	14	
Front End Controller	E441060101	78060100147	004	2	A	8	
Low Band Switch	E441060170	78060800346	005	1	A	10	
LO Synthesizer	E441060102	78060100226	003	3	G	2	
Reference	E441060108	78060300420	004	1	C	16	
Front End	E441060154	13062800820	010	2	B	9	

The Previous Page is grayed-out if the first page of information is presently displayed. The Next Page menu key is grayed-out if the last page is information is presently displayed.

Key Path:	System, Show
Mode:	All
Example:	SYST:SHOW HARD
Initial S/W Revision:	Prior to A.02.00
Help Map ID:	2677

LXI

This key shows you the product number, serial number, firmware revision, computer name, IP address, Host ID, LXI Class, LXI Version, MAC Address, and the Auto-MDIX Capability.

Key Path:	System, Show
Initial S/W Revision:	Prior to A.02.00
Help Map ID:	3499

Power On

Enables you to select how the instrument should power on. The options are: Mode and Input/Output

System Functions

System

Defaults, User Preset and Last State.

Key Path:	System
Mode:	All
Remote Command:	:SYSTem: PON: TYPE MODE USER LAST :SYSTem: PON: TYPE?
Example:	:SYST: PON: TYPE MODE
Preset:	This is unaffected by a Preset but is set to Mode on a “Restore System Defaults->All”
State Saved:	No
Backwards Compatibility SCPI:	:SYSTem: PON: TYPE PRESet the “PRESet” parameter is supported for backward compatibility only and behaves the same as MODE.
Backwards Compatibility Notes:	The Preset Type key in legacy analyzers has been removed, and the Power On toggle key has been replaced by this 1-of-N key in the System menu.
Initial S/W Revision:	Prior to A.02.00
Help Map ID:	2316

Mode and Input/Output Defaults

When the analyzer is powered on in Mode and Input/Output Defaults, it performs a Restore Mode Defaults to all modes in the instrument and also performs a Restore Input/Output Defaults.

Persistent parameters (such as Amplitude Correction tables or Limit tables) are not affected at power on, even though they are normally cleared by Restore Input/Output Defaults and/or Restore Mode Defaults.

Key Path:	System, Power On
Mode:	All
Example:	SYST: PON: TYPE MODE
Readback Text:	Defaults
Initial S/W Revision:	Prior to A.02.00
Help Map ID:	2317

User Preset

Sets **Power On** to **User Preset**. When the analyzer is powered on in User Preset, it will User Preset each mode and switch to the power-on mode. Power On User Preset will not affect any settings beyond what a normal User Preset affects.

NOTE An instrument could never power up for the first time in User Preset.

Key Path:	System, Power On
Mode:	All
Example:	SYST:PON:TYPE USER
Readback Text:	User Preset
Backwards Compatibility Notes:	Power On User Preset will cause the instrument to power up in the power-on mode, not the last mode the instrument was in prior to shut down. Also, Power On User Preset will User Preset all modes. This does not exactly match legacy behavior.
Initial S/W Revision:	Prior to A.02.00
Help Map ID:	2318

Last State

Sets **Power On** to **Last**. When the analyzer is powered on, it will put all modes in the last state they were in prior to when the analyzer was put into Power Standby and it will wake up in the mode it was last in prior to powering off the instrument. The saving of the active mode prior to shutdown happens behind the scenes when a controlled shutdown is requested by using the front panel power **Standby** key or by using the remote command `SYSTem:PDOWn`. The non-active modes are saved as they are deactivated and recalled by Power On Last State.

NOTE An instrument can never power up for the first time in Last.

If line power to the analyzer is interrupted, for example by pulling the line cord plug or by switching off power to a test rack, Power On Last State may not work properly. For proper operation, Power On Last State depends on you shutting down the instrument using the Standby key or the `SYSTem:PDOWn` SCPI command. This will ensure the last state of each mode is saved and can be recalled during a power up.

Key Path:	System, Power On
Mode:	All
Example:	SYST:PON:TYPE LAST
Notes:	Power on Last State only works if you have done a controlled shutdown prior to powering on in Last. If a controlled shutdown is not done when in Power On Last State, the instrument will power up in the last active mode, but it may not power up in the active mode's last state. If an invalid mode state is detected, a Mode Preset will occur. To control the shutdown under remote control use the <code>:SYSTem:PDOWn</code> command.
Readback Text:	Last State

Backwards Compatibility Notes:	It is no longer possible to power-up the analyzer in the last mode the analyzer was running with that mode in the preset state. (ESA/PSA SYST:PRESET:TYPE MODE with SYST:PON:PRESET) You can power-on the analyzer in the last mode the instrument was running in its last state (SYST:PON:TYPE LAST), or you can specify the mode to power-up in its preset state (SYST:PON:MODE <mode>).
Initial S/W Revision:	Prior to A.02.00
Help Map ID:	2319

Power On Application

Accesses a menu that lists the available Modes and lets you select which Mode is to be the power-on application.

This application is used for Power On Type “Mode and Input/Output Defaults” and Restore System Defaults All.

Key Path:	System, Power On
Mode:	All
Remote Command:	:SYSTem: PON: MODE SA BASIC ADEMOD NFIGURE PNOISE CDMA2K TDSCDMA VSA VSA89 601 WCDMA WIMAXOFDMA :SYSTem: PON: MODE?
Example:	SYST:PON:MODE SA
Notes:	The list of possible modes (and remote parameters) to choose from is dependent on which modes are installed in the instrument.
Preset:	This is unaffected by a Preset but is set on a “Restore System Defaults->All” to SA.
State Saved:	No
Initial S/W Revision:	Prior to A.02.00
Help Map ID:	2320

Configure Applications

The Configure Applications utility can be used to:

select applications for preload

determine how many applications can fit in memory at one time

specify the order of the Modes in the Mode menu.

This utility consists of a window with instructions, a set of “Select Application” checkboxes, a “fuel bar” style memory gauge, and keys that help you set up your configuration.

For more information, see the following topics:

[“Preloading Applications” on page 249](#)

[“Access to Configure Applications utility” on page 249](#)

[“Virtual memory usage” on page 249](#)

Key Path:	System, Power On
Example:	:SYST:SHOW CAPP Displays the Config Applications screen
Initial S/W Revision:	A.02.00
Help Map ID:	3616

Preloading Applications

During runtime, if a Mode that is not preloaded is selected using the Mode menu or sending SCPI commands, there will be a pause while the Application is loaded. During this pause a message that says “Loading application, please wait ...” is displayed. Once loaded, the application stays loaded, so the next time you select it during a session, there is no delay.

Preloading enables you to “preload” at startup, to eliminate the runtime delay. Preloading an application will cause it to be loaded into the analyzer’s memory when the analyzer program starts up. If you do this, the delay will increase the time it takes to start up the analyzer program, but this may be preferable to having to wait the first time you select an application. Note that, once an application is loaded into memory, it cannot be unloaded without exiting and restarting the analyzer program.

Note that there are more applications available for the X-Series than can fit into Windows Virtual Memory. By allowing you to choose which licensed applications to load at startup, the Configure Applications utility allows you to make optimal use of your memory.

Access to Configure Applications utility

A version of the utility runs the first time you power up the analyzer after purchasing it from Agilent. The utility automatically configures preloads so that as many licensed applications as possible are preloaded while keeping the total estimated virtual memory usage below the limit. This auto-configuration only takes place at the very first run, and after analyzer software upgrades.

You may, at any time, manually call up the Configure Applications utility by pressing System, Power On, Configure Applications, to find a configuration that works best for you, and then restart the analyzer program.

The utility may also be called if, during operation of the analyzer, you attempt to load more applications than can fit in memory at once.

Virtual memory usage

There are more applications available for the X-Series than can fit into memory at any one time, so the Configure Applications utility includes a memory tracker that serves two purposes:

It will not let you preload more applications than will fit into memory at once.

You can determine how many of your favorite applications can reside in memory at one time.

The utility provides a graphical representation of the amount of memory (note that the memory in

System Functions

System

question here is Virtual memory and is a limitation imposed by the operating system, not by the amount of physical memory you have in your analyzer). You select applications to preload by checking the boxes on the left. Checked applications preload at startup. The colored fuel bar indicates the total memory required when all the checked applications are loaded (either preloaded or selected during runtime).

Here is what the fuel bar colors mean:

RED: the applications you have selected cannot all fit into the analyzer's memory. You must deselect applications until the fuel bar turns yellow.

YELLOW: the applications you have selected can all fit into the analyzer's memory, but there is less than 10% of the memory left, probably not enough to load any other applications, either via preload or by selecting a Mode while the analyzer is running..

GREEN: The indicator is green when <90% of the memory limit is consumed. This means the applications you have selected can all fit into the analyzer's memory with room to spare. You will likely be able to load one or more other applications without running out of memory.

Select All

Marks all applications in the selection list. This allows you to enable all applications licensed on the instrument for pre-loading, or is a convenience for selecting all applications in one operation and then letting you deselect individual applications.

Key Path:	System, Power On, Configure Applications
Initial S/W Revision:	A.02.00
Help Map ID:	3617

Deselect All

Clears the marks from all applications in the selection list, except the Power On application. The Power On application cannot be eliminated from the pre-load list.

Key Path:	System, Power On, Configure Applications
Initial S/W Revision:	A.02.00
Help Map ID:	3618

Move Up

The application list is the order that applications appear in the Mode Menu. This key enables you to shift the selected application up in the list, thus moving the selected application earlier in the Mode Menu.

Key Path:	System, Power On, Configure Applications
Initial S/W Revision:	A.02.00
Help Map ID:	3619

Move Down

The application list is the order that applications appear in the Mode Menu. This key enables you to shift the selected application down in the list, thus moving the selected application later in the Mode Menu.

Key Path:	System, Power On, Configure Applications
Initial S/W Revision:	A.02.00
Help Map ID:	3620

Select/Deselect

Toggles the currently highlighted application in the list.

Key Path:	System, Power On, Configure Applications
Initial S/W Revision:	A.02.00
Help Map ID:	3621

Save Changes and Exit

Applies the configuration of the applications list. The marked applications will be pre-loaded in memory the next time the instrument application is started, and the order of the applications in the list will be the order of the applications in the Mode Menu.

After saving your changes, the analyzer asks you if you would like it to restart so that your changes can take effect (see dialog box, below). If you choose not to restart, the changes will not take affect until the next time you shut down and restart the analyzer.

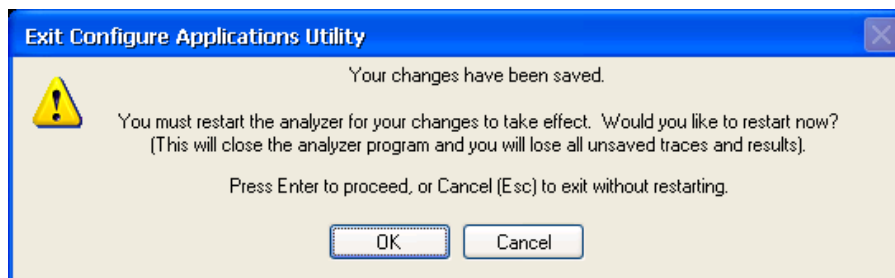

Key Path:	System, Power On, Configure Applications
Remote Command:	:SYSTem:PUP:PROcess
Example:	:SYST:PUP:PROC This is the SCPI command for restarting the analyzer. You must Wait after this command for the instrument application to restart
Notes:	The softkey will be grayed-out when the virtual memory of the selected applications exceeds 100% of the limit.

Notes:	You cannot use *WAI or *OPC? to synchronize operation after a restart. This command stops and restarts the instrument application, thus the SCPI operation is terminated and restarted. A remote program must use fixed wait time to resume sending commands to the instrument. The wait time will be dependent upon which applications are pre-loaded.
Initial S/W Revision:	A.02.00
Modified at S/W Revision:	A.04.00
Help Map ID:	3622

Exit Without Saving

Pressing this key will exit the Configure Applications utility without saving your changes.

Key Path:	System, Power On, Configure Applications
Initial S/W Revision:	A.02.00
Modified at S/W Revision:	A.04.00
Help Map ID:	3623

Configure Applications - Instrument boot-up

At start-up of the analyzer program a dialog box similar to the one under the **System, Power On, Configure Applications** key will be displayed allowing you to choose which licensed applications are to be loaded. This dialog will only be displayed if the memory required to pre-load all of the licensed applications exceeds the Virtual Memory available.

Configure Applications - Windows desktop

The Configure Applications Utility may be run from the Windows Desktop. The utility is launched by



double-clicking the icon on the desktop, which brings-up a dialog box similar to the one under the **System, Power On, Configure Applications** key, allowing you to choose which licensed applications are to be loaded when the analyzer program starts up. This dialog box has mouse buttons on it that do the job the softkeys normally do in the **System, Power On, Configure Applications** menu.

Configure Applications - Remote Commands

The following topics provide details on using remote commands to configure the list of applications you want to load into the instrument memory or query the Virtual Memory utilization for your applications.

[“Configuration list \(Remote Command Only\)” on page 253](#)

[“Configuration Memory Available \(Remote Command Only\)” on page 253](#)

[“Configuration Memory Total \(Remote Command Only\)” on page 253](#)

[“Configuration Memory Used \(Remote Command Only\)” on page 254](#)

[“Configuration Application Memory \(Remote Command Only\)” on page 254](#)

Configuration list (Remote Command Only)

This remote command is used to set or query the list of applications to be loaded in-memory.

Remote Command:	:SYSTem:PON:APPLication:LLIST <string of INSTRument:SElect names> :SYSTem:PON:APPLication:LLIST?
Example:	:SYST:PON:APPL:LLIS "SA,BASIC,WCDMA"
Notes:	<string of INSTRument:SElect names> are from the enums of the :INSTRument:SElect command. The order of the <INSTRument:SElect names> is the order that the applications are loaded into memory, and the order that they appear in the Mode Menu. Error message –225 "Out of Memory" is reported when more applications are listed than can reside in Virtual Memory. When this occurs, the existing applications load list is unchanged.
Preset:	Not affected by Preset
State Saved:	Not saved in instrument state
Initial S/W Revision:	A.02.00
Help Map ID:	0

Configuration Memory Available (Remote Command Only)

This remote command is used to query the amount of Virtual Memory remaining.

Remote Command:	:SYSTem:PON:APPLication:VMEMory[:AVAIlable]?
Example:	:SYST:PON:APPL:VMEM?
Preset:	Not affected by Preset
Initial S/W Revision:	A.02.00
Help Map ID:	0

Configuration Memory Total (Remote Command Only)

This remote command is used to query the limit of Virtual Memory allowed for applications.

Remote Command:	:SYSTem:PON:APPLication:VMEMory:TOTal?
Example:	:SYST:PON:APPL:VMEM:TOT?
Preset:	Not affected by Preset
Initial S/W Revision:	A.02.00
Help Map ID:	0

Configuration Memory Used (Remote Command Only)

This remote command is a query of the amount of Virtual Memory used by all measurement applications.

Remote Command:	:SYSTem:PON:APPLication:VMEMory:USED?
Example:	:SYST:PON:APPL:VMEM:USED?
Preset:	Not affected by Preset
Initial S/W Revision:	A.02.00
Help Map ID:	0

Configuration Application Memory (Remote Command Only)

This remote command is used to query the amount of Virtual Memory a particular application consumes.

Remote Command:	:SYSTem:PON:APPLication:VMEMory:USED:NAME? <INSTRument:SElect name>
Example:	:SYST:PON:APPL:VMEM:USED:NAME? CDMA2K
Notes:	<INSTRument:SElect name> is from the enums of the :INSTRument:SElect command Value returned will be 0 (zero) if the name provided is invalid.
Preset:	Not affected by Preset
Initial S/W Revision:	Prior to A.02.00
Help Map ID:	0

Restore Power On Defaults

This selection causes the Power On Type and Power On Application settings to be a reset to their default values. This level of Restore System Defaults does not affect any other system settings, mode settings and does not cause a mode switch. The Power On key, under the Restore System Defaults menu, causes the same action.

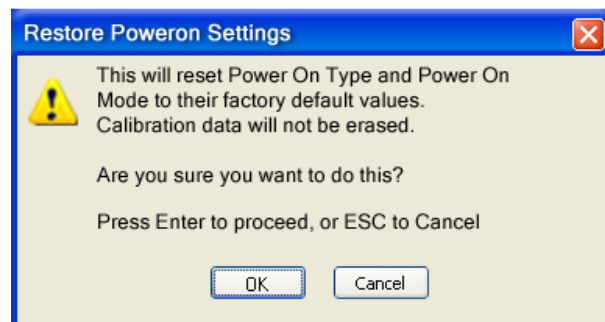

If you press any key other than OK or Enter, it is construed as a Cancel, because the only path that will

actually cause the reset to be executed is through OK or Enter.

Key Path:	System, Power On
Example:	:SYST:DEF PON
Initial S/W Revision:	Prior to A.02.00
Help Map ID:	2321

Alignments

The Alignments Menu controls and displays the automatic alignment of the instrument, and provides the ability to restore the default alignment values.

The current setting of the alignment system is displayed in the system Settings Panel along the top of the display, including a warning icon for conditions that may cause specifications to be impacted.



Key Path:	System
Initial S/W Revision:	Prior to A.02.00
Help Map ID:	2000

Auto Align

Configures the method for which the automatic background alignment is run.

Automatic background alignments are run periodically between measurement acquisitions. The instrument's software determines when alignments are to be performed to maintain warranted operation. The recommended setting for Auto Align is Normal.

An Auto Align execution cannot be aborted with the Cancel (ESC) key. To interrupt an Auto Align execution, select **Auto Align Off**.

Key Path:	System, Alignments
Mode:	All
Remote Command:	:CALibration:AUTO ON PARTial OFF :CALibration:AUTO?
Example:	:CAL:AUTO ON
Notes:	While Auto Align is executing, bit 0 of Status Operation register is set.
Couplings:	Auto Align is set to Off if Restore Align Data is invoked.
Preset:	This is unaffected by Preset but is set to ON upon a "Restore System Defaults->Align".
State Saved:	No

System Functions
System

Status Bits/OPC dependencies:	When Auto Align is executing, bit 0 in the Status Operational register is set.
Backwards Compatibility SCPI:	:CALibration:AUTO ALERt Parameter ALERt is for backward compatibility only and is mapped to PARTial
Backwards Compatibility Notes:	ESA SCPI for Auto Align is :CALibration:AUTO <Boolean>. The command for X-Series is an enumeration. Thus the parameters of “0” and “1” are not possible in X-Series. Similarly, the ESA SCPI for :CALibration:AUTO? returned the Boolean value 1 or 0, in X-Series it is an Enumeration (string). Thus, queries by customer applications into numeric variables will result in an error In PSA Auto Align OFF was not completely off, it is equivalent to PARTial in X-Series. In X-Series, OFF will be fully OFF. This means users of PSA SCPI who choose OFF may see degraded performance and should migrate their software to use PARTial.
Initial S/W Revision:	Prior to A.02.00
Help Map ID:	2001

Normal

Auto Align, Normal turns on the automatic alignment of all measurement systems. The Auto Align, Normal selection maintains the instrument in warranted operation across varying temperature and over time.

If the condition “Align Now, All required” is set, transition to Auto Align, Normal will perform the required alignments and clear the “Align Now, All required” condition and then continue with further alignments as required to maintain the instrument adequately aligned for warranted operation.

When **Auto Align, Normal** is selected the Auto Align Off time is set to zero.

When **Auto Align, Normal** is selected the Settings Panel indicates ALIGN AUTO.

Key Path:	System, Alignments, Auto Align
Mode:	All
Example:	:CAL:AUTO ON
Notes:	Alignment processing as a result of the transition to Normal will be executed sequentially. Thus, *OPC? or *WAI following CAL:AUTO ON will return when the alignment processing is complete. The presence of an external signal may interfere with the RF portion of the alignment. If so, the Error Condition message “Align skipped: 50 MHz interference” or “Align skipped: 4.8 GHz interference” is reported, and bit 11 is set in the Status Questionable Calibration register. After the interfering signal is removed, subsequent alignment of the RF will clear the condition, and clear bit 11 in the Status Questionable Calibration register.
Readback Text:	Normal

Status Bits/OPC dependencies:	An interfering user signal may prevent automatic alignment of the RF subsystem. If this occurs, the Error Condition message “Align skipped: 50 MHz interference” or “Align skipped: 4.8 GHz interference” is reported, the Status Questionable Calibration bit 11 is set, and the alignment proceeds. When a subsequent alignment of the RF subsystem succeeds, either by the next cycle of automatic alignment or from an Align Now, RF, the Error Condition and Status Questionable Calibration bit 11 are cleared.
Initial S/W Revision:	Prior to A.02.00
Help Map ID:	2002

Partial

Auto Align, Partial disables the full automatic alignment and the maintenance of warranted operation for the benefit of improved measurement throughput. Accuracy is retained for the Resolution Bandwidth filters and the IF Passband which is critical to FFT accuracy, demodulation, and many measurement applications. With Auto Align set to Partial, you are now responsible for maintaining warranted operation by updating the alignments when they expire. The Auto Align, Alert mechanism will notify you when alignments have expired. One solution to expired alignments is to perform the Align All, Now operation. Another is to return the Auto Align selection to Normal.

Auto Align, Partial is recommended for measurements where the throughput is so important that a few percent of improvement is more valued than an increase in the accuracy errors of a few tenths of a decibel. One good application of Auto Align, Partial would be an automated environment where the alignments can be called during overhead time when the device-under-test is exchanged.

When **Auto Align, Partial** is selected the elapsed time counter begins for Auto Align Off time.

When **Auto Align, Partial** is selected the Settings Panel indicates ALIGN PARTIAL with a warning icon. The warning icon is to inform the operator that they are responsible for maintaining the warranted operation of the instrument

Key Path:	System, Alignments, Auto Align
Mode:	All
Example:	:CAL:AUTO PART
Notes:	Auto Align Partial begins the elapsed time counter for Auto Align Off time.
Readback Text:	Partial
Initial S/W Revision:	Prior to A.02.00
Help Map ID:	2003

Off

Auto Align, Off disables automatic alignment and the maintenance of warranted operation, for the benefit of maximum measurement throughput. With Auto Align set to Off, you are now responsible for maintaining warranted operation by updating the alignments when they expire. The Auto Align, Alert mechanism will notify you when alignments have expired. One solution to expired alignments is to perform the Align All, Now operation. Another is to return the Auto Align selection to Normal.

System Functions
System

The Auto Align, Off setting is rarely the best choice, because Partial gives almost the same improvement in throughput while maintaining the warranted performance for a much longer time. The choice is intended for unusual circumstances such as the measurement of radar pulses where you might like the revisit time to be as consistent as possible.

When **Auto Align, Off** is selected the Auto Align Off time is initialized and the elapsed time counter begins.

When **Auto Align, Off** is selected the Settings Panel indicates ALIGN OFF with a warning icon. The warning icon is to inform the operator that they are responsible for maintaining the warranted operation of the instrument:

Key Path:	System, Alignments, Auto Align
Mode:	All
Example:	:CAL:AUTO OFF
Notes:	Auto Align Off begins the elapsed time counter for Auto Align Off time.
Couplings:	Auto Align is set to Off if Restore Align Data is invoked.
Readback Text:	Off
Initial S/W Revision:	Prior to A.02.00
Help Map ID:	2004

All but RF

Auto Align, All but RF, configures automatic alignment to include or exclude the RF subsystem. (Eliminating the automatic alignment of the RF subsystem prevents the input impedance from changing. The normal input impedance of 50 ohms can change to an open circuit when alignments are being used. Some devices under test do not behave acceptably under such circumstances, for example by showing instability.) When Auto Align, All but RF ON is selected, the operator is responsible for performing an Align Now, RF when RF-related alignments expire. The Auto Align, Alert mechanism will notify the operator to perform an Align Now, All when the combination of time and temperature variation is exceeded.

When Auto Align, All but RF ON is selected the Settings Panel indicates ALIGN AUTO/NO RF with a warning icon (warning icon is intended to inform the operator they are responsible for the maintaining the RF alignment of the instrument):

Key Path:	System, Alignments, Auto Align
Mode:	All
Remote Command:	:CALibration:AUTO:MODE ALL NRF :CALibration:AUTO:MODE?
Example:	:CAL:AUTO:MODE NRF
Preset:	This is unaffected by Preset but is set to ALL on a "Restore System Defaults->Align".

State Saved:	No
Readback Text:	RF or NRF
Initial S/W Revision:	Prior to A.02.00
Help Map ID:	2005

Alert

The instrument will signal an Alert when conditions exist such that you will need to perform a full alignment (for example, Align Now, All). The Alert can be configured in one of four settings; Time & Temperature, 24 hours, 7 days, or None. A confirmation is required when a selection other than Time & Temperature is chosen. This prevents accidental deactivation of alerts.

With Auto Align set to Normal, the configuration of Alert is not relevant because the instrument's software maintains the instrument in warranted operation.

Key Path:	System, Alignments, Auto Align
Mode:	All
Remote Command:	:CALibration:AUTO:ALERT TTEMperature DAY WEEK NONE :CALibration:AUTO:ALERT?
Example:	:CAL:AUTO:ALER TTEM
Notes:	The alert that alignment is needed is the setting of bit 14 in the Status Questionable Calibration register.
Preset:	This is unaffected by Preset but is set to TTEMperature on a "Restore System Defaults->Align".
State Saved:	No
Status Bits/OPC dependencies:	The alert is the Error Condition message "Align Now, All required" and bit 14 is set in the Status Questionable Calibration register.
Initial S/W Revision:	Prior to A.02.00
Help Map ID:	2006

Time & Temperature

With Auto Align Alert set to Time & Temperature the instrument will signal an alert when alignments expire due to the combination of the passage of time and changes in temperature. The alert is the Error Condition message "Align Now, All required". If this choice for Alert is selected, the absence of an alert means that the analyzer alignment is sufficiently up-to-date to maintain warranted accuracy.

Key Path:	System, Alignments, Auto Align, Alert
Mode:	All
Example:	:CAL:AUTO:ALER TTEM
Readback Text:	Time & Temp

System Functions
System

Status Bits/OPC dependencies:	Bit 14 is set in the Status Questionable Calibration register.
Initial S/W Revision:	Prior to A.02.00
Help Map ID:	2007

24 hours

With Auto Align Alert set to 24 Hours the instrument will signal an alert after a time span of 24 hours since the last successful full alignment (for example, Align Now, All or completion of a full Auto Align). You may choose this selection in an environment where the temperature is stable on a daily basis at a small risk of accuracy errors in excess of the warranted specifications. The alert is the Error Condition message “Align Now, All required”.

For front-panel operation , confirmation is required to transition into this setting of Alert. The confirmation dialog is:

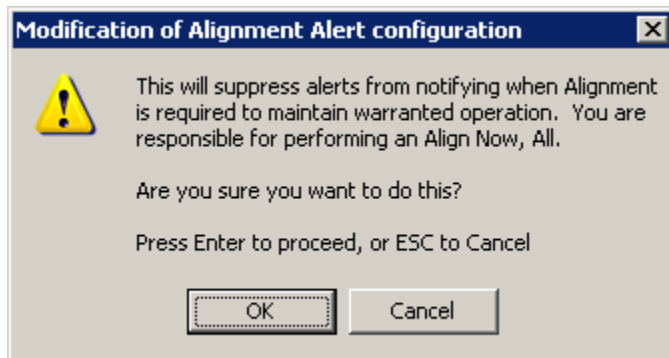

No confirmation is required when Alert is configured through a remote command.

Key Path:	System, Alignments, Auto Align, Alert
Mode:	All
Example:	:CAL:AUTO:ALER DAY
Readback Text:	24 hours
Status Bits/OPC dependencies:	Bit 14 is set in the Status Questionable Calibration register.
Initial S/W Revision:	Prior to A.02.00
Help Map ID:	2008

7 days

With Auto Align Alert is set to 7 days the instrument will signal an alert after a time span of 168 hours since the last successful full alignment (for example, Align Now, All or completion of a full Auto Align). You may choose this selection in an environment where the temperature is stable on a weekly basis, at a modest risk of accuracy degradations in excess of warranted performance. The alert is the Error Condition message “Align Now, All required”.

For front panel operation, confirmation is required for the customer to transition into this setting of Alert. The confirmation dialog is:

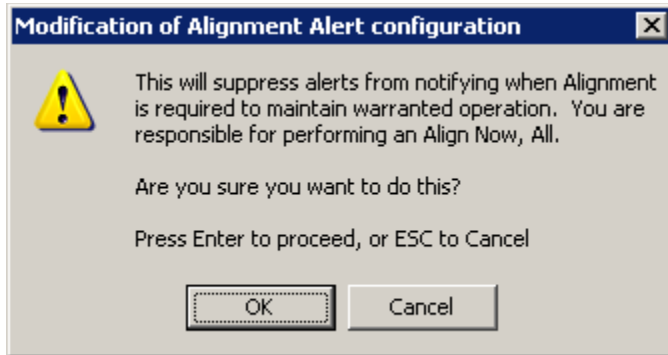

No confirmation is required when Alert is configured through a remote command.

Key Path:	System, Alignments, Auto Align, Alert
Mode:	All
Example:	:CAL:AUTO:ALER WEEK
Readback Text:	7 days
Status Bits/OPC dependencies:	Bit 14 is set in the Status Questionable Calibration register.
Initial S/W Revision:	Prior to A.02.00
Help Map ID:	2009

None

With Auto Align Alert set to None the instrument will not signal an alert. This is provided for rare occasions where you are making a long measurement which cannot tolerate Auto Align interruptions, and must have the ability to capture a screen image at the end of the measurement without an alert posted to the display. Agilent does not recommend using this selection in any other circumstances, because of the risk of accuracy performance drifting well beyond expected levels without the operator being informed.

For front panel operation, confirmation is required to transition into this setting of Alert. The confirmation dialog is:

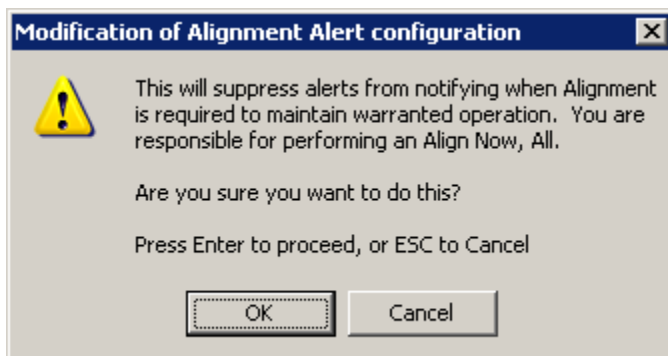

System Functions

System

No confirmation is required when Alert is configured through a remote command.

Key Path:	System, Alignments, Auto Align, Alert
Mode:	All
Example:	:CAL:AUTO:ALER NONE
Initial S/W Revision:	Prior to A.02.00
Help Map ID:	2010

Execute Expired Alignments (Remote Command Only)

Alignments can be expired in the situation where Auto Align is in the state of Partial or Off. This feature runs the alignments that have expired. This is different than performing an Align All, Now operation. Align All, Now performs an alignment of all subsystems regardless of whether they are needed or not, with Execute Expired Alignments, only the individual subsystems that have become due are aligned.

Mode:	All
Remote Command:	:CALibration:EXPIred?
Example:	:CAL:EXP?
Notes:	:CALibration:EXPIred? returns 0 if successful :CALibration:EXPIred? returns 1 if failed
Initial S/W Revision:	Prior to A.02.00
Help Map ID:	0

Align Now

Accesses alignment processes that are immediate action operations. They perform complete operations and run until they are complete.

Key Path:	System, Alignments
Initial S/W Revision:	Prior to A.02.00
Help Map ID:	2011

All

Immediately executes an alignment of all subsystems. The instrument stops any measurement currently underway, performs the alignment, then restarts the measurement from the beginning (similar to pressing the **Restart** key).

If an interfering user signal is present at the RF Input, the alignment is performed on all subsystems except the RF. After completion, the Error Condition message “Align skipped: 50 MHz interference” or “Align skipped: 4.8 GHz interference” is generated. In addition the Error Condition message “Align Now, RF required” is generated, and bits 11 and 12 are set in the Status Questionable Calibration register.

The query form of the remote commands (:CALibration[:ALL]? or *CAL?) invokes the alignment of all subsystems and returns a success or failure value. An interfering user signal is not grounds for failure; if the alignment was able to succeed on all portions but unable to align the RF because of an interfering signal, the resultant will be the success value.

Successful completion of **Align Now, All** will clear the “Align Now, All required” Error Condition, and clear bit 14 in the Status Questionable Calibration register. It will also begin the elapsed time counter for Last Align Now, All Time, and capture the Last Align Now, All Temperature.

If the Align RF subsystem succeeded in aligning (no interfering signal present), the elapsed time counter begins for Last Align Now, RF Time, and the temperature is captured for the Last Align Now, RF Temperature. In addition the Error Conditions “Align skipped: 50 MHz interference” and “Align skipped: 4.8 GHz interference” are cleared, the Error Condition “Align Now, RF required” is cleared, and bits 11 and 12 are cleared in the Status Questionable Calibration register

Align Now, All can be interrupted by pressing the Cancel (ESC) front-panel key or remotely with Device Clear followed by the :ABORt SCPI command. When this occurs the Error Condition message “Align Now, All required” is generated, and bit 14 is set in the Status Questionable Condition register. This is because new alignment data may be employed for an individual subsystem, but not a cohesive set of data for all subsystems.

In many cases, you might find it more convenient to change alignments to Normal, instead of executing Align Now, All. When the Auto Align process transitions to Normal, the analyzer will immediately start to update only the alignments that have expired, thus efficiently restoring the alignment process.

In models with the RF Preselector, such as the N9038A, the Align Now All alignment will immediately execute an alignment of all subsystems in the Spectrum Analyzer and partial subsystems of the RF Preselector. The additional alignments are the System Gain, Mechanical attenuator and Electronic attenuator alignments on the RF Preselector path. The purpose of these alignments is to improve the RF Preselector path amplitude variation compared to the bypass path.

Key Path:	System, Alignments, Align Now
Mode:	All
Remote Command:	:CALibration[:ALL] :CALibration[:ALL]?
Example:	:CAL

Notes:	<p>:CALibration[:ALL]? returns 0 if successful</p> <p>:CALibration[:ALL]? returns 1 if failed</p> <p>:CALibration[:ALL]? is the same as *CAL?</p> <p>While Align Now, All is performing the alignment, bit 0 in the Status Operation register is set. Completion, or termination, will clear bit 0 in the Status Operation register.</p> <p>This command is sequential; it must complete before further SCPI commands are processed. Interrupting the alignment from remote is accomplished by invoking Device Clear followed by the :ABORt command.</p> <p>Successful completion will clear bit 14 in the Status Questionable Calibration register.</p> <p>An interfering user signal is not grounds for failure of Align Now, All. However, bits 11 and 12 are set in the Status Questionable Calibration register to indicate Align Now, RF is required.</p> <p>An interfering user supplied signal will result in the instrument requiring an Align Now, RF with the interfering signal removed.</p>
Couplings:	<p>Initializes the time for the Last Align Now, All Time.</p> <p>Records the temperature for the Last Align Now, All Temperature.</p> <p>If Align RF component succeeded, initializes the time for the Last Align Now, RF Time.</p> <p>If Align RF component succeeded, records the temperature for the Last Align Now, RF Temperature.</p>
Status Bits/OPC dependencies:	Bits 11, 12, or 14 may be set in the Status Questionable Calibration register.
Initial S/W Revision:	Prior to A.02.00
Help Map ID:	2012

Mode:	All
Remote Command:	*CAL?
Example:	*CAL?
Notes:	<p>*CAL? returns 0 if successful</p> <p>*CAL? returns 1 if failed</p> <p>:CALibration[:ALL]? is the same as *CAL?</p> <p>See additional remarks described with :CALibration[:ALL]?</p> <p>Everything about :CALibration[:ALL]? is synonymous with *CAL? including all conditions, status register bits, and couplings</p>
Initial S/W Revision:	Prior to A.02.00
Help Map ID:	0

All but RF

Immediately executes an alignment of all subsystems except the RF subsystem. The instrument will stop any measurement currently underway, perform the alignment, and then restart the measurement from the beginning (similar to pressing the Restart key). This can be used to align portions of the instrument that are not impacted by an interfering user input signal.

This operation might be chosen instead of **All** if you do not want the device under test to experience a large change in input impedance, such as a temporary open circuit at the analyzer input.

The query form of the remote commands (:CALibration:NRF?) will invoke the alignment and return a success or failure value.

Successful completion of Align Now, All but RF will clear the “Align Now, All required” Error Condition, and clear bit 14 in the Status Questionable Calibration register. If “Align Now, All required” was in effect prior to executing the All but RF, the Error Condition message “Align Now, RF required” is generated and bit 12 in the Status Questionable Calibration register is set. It will also begin the elapsed time counter for Last Align Now, All Time, and capture the Last Align Now, All Temperature.

Align Now, All but RF can be interrupted by pressing the Cancel (ESC) front-panel key or remotely with Device Clear followed by the :ABORt SCPI command. When this occurs the Error Condition message “Align Now, All required” is generated, and bit 14 is set in the Status Questionable Condition register. This is because new alignment data may be used for an individual subsystem, but not a full new set of data for all subsystems.

In models with the RF Preselector, such as the N9038A, the “All but RF” alignment will execute an alignment of all subsystems except the RF subsystem of the Spectrum Analyzer, as well as the system gain of the RF Preselector.

Key Path:	System, Alignments, Align Now
Mode:	All
Remote Command:	:CALibration:NRF :CALibration:NRF?
Example:	:CAL:NRF
Notes:	:CALibration:NRF? returns 0 if successful :CALibration:NRF? returns 1 if failed While Align Now, All but RF is performing the alignment, bit 0 in the Status Operation register is set. Completion, or termination, will clear bit 0 in the Status Operation register. This command is sequential; it must complete before further SCPI commands are processed. Interrupting the alignment from remote is accomplished by invoking Device Clear followed by the :ABORt command. Successful completion will clear bit 14 in the Status Questionable Calibration register and set bit 12 if invoked with “Align Now, All required”.
Couplings:	Initializes the time for the Last Align Now, All Time. Records the temperature for the Last Align Now, All Temperature.

System Functions
System

Status Bits/OPC dependencies:	Bits 12 or 14 may be set in the Status Questionable Calibration register.
Initial S/W Revision:	Prior to A.02.00
Help Map ID:	2013

RF

Immediately executes an alignment of the RF subsystem. The instrument stops any measurement currently underway, performs the alignment, then restarts the measurement from the beginning (similar to pressing the **Restart** key).

This operation might be desirable if the alignments had been set to not include RF alignments, or if previous RF alignments could not complete because of interference which has since been removed.

If an interfering user signal is present at the RF Input, the alignment will terminate and generate the Error Condition message “Align skipped: 50 MHz interference” or “Align skipped: 4.8 GHz interference”, and Error Condition “Align Now, RF required”. In addition, bits 11 and 12 will be set in the Status Questionable Calibration register.

The query form of the remote commands (:CALibration:RF?) will invoke the alignment of the RF subsystem and return a success or failure value. An interfering user signal is grounds for failure.

Successful completion of Align Now, RF will begin the elapsed time counter for Last Align Now, RF Time, and capture the Last Align Now, RF Temperature.

Align Now, RF can be interrupted by pressing the Cancel (ESC) front-panel key or remotely with Device Clear followed by the :ABORt SCPI command. When this occurs, the Error Condition message “Align Now, RF required” is generated, and bit 12 is set in the Status Questionable Condition register. None of the new alignment data is used.

In models with the RF Preselector, such as the N9038A, the RF alignment will execute an alignment of the RF subsystem of the Spectrum Analyzer, as well as the RF subsystem on RF Preselector path.

Key Path:	System, Alignments, Align Now
Mode:	All
Remote Command:	:CALibration:RF :CALibration:RF?
Example:	:CAL:RF

Notes:	<p>:CALibration:RF? returns 0 if successful</p> <p>:CALibration:RF? returns 1 if failed (including interfering user signal)</p> <p>While Align Now, RF is performing the alignment, bit 0 in the Status Operation register is set. Completion, or termination, will clear bit 0 in the Status Operation register.</p> <p>This command is sequential; it must complete before further SCPI commands are processed. Interrupting the alignment from remote is accomplished by invoking Device Clear followed by the :ABORt command.</p> <p>Successful completion clears the Error Conditions “Align skipped: 50 MHz interference” and “Align skipped: 4800 MHz interference” and the Error Conditions “Align RF failed” and “Align Now, RF required”, and clears bits 3, 11, and 12 in the Status Questionable Calibration register.</p> <p>A failure encountered during alignment will generate the Error Condition message “Align RF failed” and set bit 3 in the Status Questionable Calibration register.</p> <p>An interfering user signal will result in bits 11 and 12 to be set in the Status Questionable Calibration register to indicate Align Now, RF is required.</p> <p>An interfering user supplied signal will result in the instrument requiring an Align Now, RF with the interfering signal removed.</p>
Couplings:	<p>Initializes the time for the Last Align Now, RF Time.</p> <p>Records the temperature for the Last Align Now, RF Temperature.</p>
Status Bits/OPC dependencies:	Bits 11, 12, or 14 may be set in the Status Questionable Calibration register.
Initial S/W Revision:	Prior to A.02.00
Help Map ID:	2014

External Mixer

Immediately executes an alignment of the External Mixer that is plugged into the USB port. The instrument stops any measurement currently underway, performs the alignment, then restarts the measurement from the beginning (similar to pressing the Restart key). As this alignment calibrates the LO power to the mixer, this is considered an LO alignment; and failure is classified as an LO alignment failure.

The query form of the remote commands (:CALibration:EMIXer?) will invoke the alignment of the External Mixer and return a success or failure value.

Key Path:	System, Alignments, Align Now
Mode:	All
Remote Command:	:CALibration:EMIXer :CALibration:EMIXer?
Example:	:CAL:EMIX

System Functions
System

Notes:	<p>:CAL:EMIX? returns 0 if successful</p> <p>:CAL:EMIX? returns 1 if failed</p> <p>While Align Now, Ext Mix is performing the alignment, bit 0 in the Status Operation register is set. Completion, or termination, will clear bit 0 in the Status Operation register.</p> <p>This command is sequential; it must complete before further SCPI commands are processed. Interrupting the alignment from remote is accomplished by invoking Device Clear followed by the :ABORt command.</p> <p>A failure encountered during alignment will generate the Error Condition message “Align LO failed” and set bit 5 in the Status Questionable Calibration register. Successful completion will clear the “Align LO failed” message and bit 5 in the Status Questionable Calibration register.</p>
Dependencies:	This key does not appear unless option EXM is present and is grayed-out unless a USB mixer is plugged in to the USB.
Status Bits/OPC dependencies:	Bit3 may be set in the Status Questionable Calibration Extended Failure register.
Initial S/W Revision:	A.08.00
Help Map ID:	3672

Source

This menu is only available in the EXT (E6607A).

Accesses source alignment processes that are immediate action operations. They perform complete operations and run until they are complete.

Immediately executes an IQ alignment of the complete source. The instrument stops any sequence of the source, performs the alignment, then restarts the sequence from the beginning.

There is no alert available for the source alignment. The operators have the responsibility to check temperature shift since last Align Now, Source to determine if the source alignment need to be executed.

Key Path:	System, Alignments, Align Now
Mode:	All
Remote Command:	:CALibration:INTernal:SOURce[:ALL] :CALibration:INTernal:SOURce[:ALL]?
Example:	:CAL:INT:SOUR
Notes:	<p>Only available in: XOBT</p> <p>:CAL:SOUR? Initiates an Alignment and returns 0 if successful</p> <p>:CAL:SOUR? Initiates an Alignment and returns 1 if failed</p>
Couplings:	<p>Initializes the time for the Last Align Source Now, All Time.</p> <p>Records the temperature for the Last Align Source Now, All Temperature.</p>

Status Bits/OPC dependencies:	Bits TODO may be set in the Status Questionable Calibration register
Initial S/W Revision:	A.05.00
Help Map ID:	3652

Show Alignment Statistics

Shows alignment information you can use to ensure that the instrument is operating in a specific manner. The Show Alignment Statistics screen is where you can view time and temperature information.

Values which are displayed are only updated when the Show Alignment Statistics screen is invoked, they are not updated while the Show Alignment Statistics screen is being displayed. The remote commands that access this information obtain current values.

An example of the Show Alignment Statistics screen would be similar to:

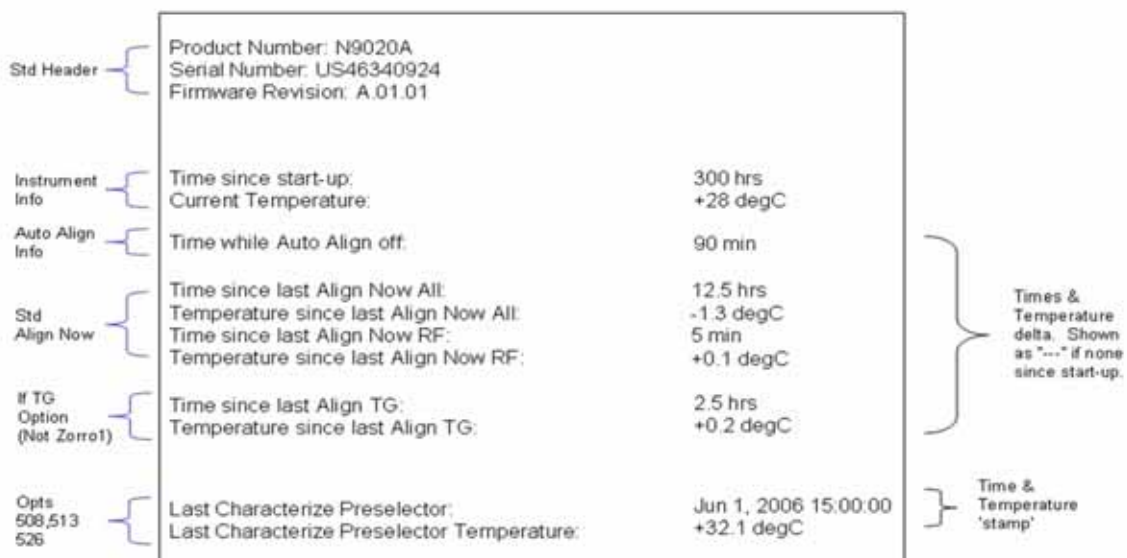

A successful Align Now, RF will set the Last Align RF temperature to the current temperature, and reset the Last Align RF time. A successful Align Now, All or Align Now, All but RF will set the Last Align Now All temperature to the current temperature, and reset the Last Align Now All time. A successful Align Now, All will also reset the Last Align RF items if the RF portion of the Align Now succeeded.

Key Path:	System, Alignments
Mode:	All
Notes:	The values displayed on the screen are only updated upon entry to the screen and not updated while the screen is being displayed.
Initial S/W Revision:	Prior to A.02.00
Help Map ID:	2018

System Functions
System

Key Path:	Visual annotation in the Show Alignment Statistics screen
Mode:	All
Remote Command:	:SYSTem:PON:TIME?
Example:	:SYST:PON:TIME?
Notes:	Value is the time since the most recent start-up in seconds.
State Saved:	No
Initial S/W Revision:	Prior to A.02.00
Help Map ID:	0

Key Path:	Visual annotation in the Show Alignment Statistics screen
Mode:	All
Remote Command:	:CALibration:TEMPerature:CURRent?
Example:	:CAL:TEMP:CURR?
Notes:	Value is in degrees Centigrade. Value is invalid if using default alignment data (Align Now, All required)
State Saved:	No
Initial S/W Revision:	Prior to A.02.00
Help Map ID:	0

Key Path:	Visual annotation in the Show Alignment Statistics screen
Mode:	All
Remote Command:	:CALibration:TIME:LALL?
Example:	:CAL:TIME:LALL?
Notes:	Value is the elapsed time, in seconds, since the last successful Align Now, All or Align Now, All but RF was executed.
State Saved:	No
Initial S/W Revision:	Prior to A.02.00
Help Map ID:	0

Key Path:	Visual annotation in the Show Alignment Statistics screen
Mode:	All
Remote Command:	:CALibration:TEMPerature:LALL?
Example:	:CAL:TEMP:LALL?

Notes:	Value is in degrees Centigrade at which the last successful Align Now, All or Align Now, All but RF was executed.
State Saved:	No
Initial S/W Revision:	Prior to A.02.00
Help Map ID:	0

Key Path:	Visual annotation in the Show Alignment Statistics screen
Mode:	All
Remote Command:	:CALibration:TIME:LRF?
Example:	:CAL:TIME:LRF?
Notes:	Value is the elapsed time, in seconds, since the last successful Align Now, RF was executed, either individually or as a component of Align Now, All.
State Saved:	No
Initial S/W Revision:	Prior to A.02.00
Help Map ID:	0

Key Path:	Visual annotation in the Show Alignment Statistics screen
Mode:	All
Remote Command:	:CALibration:TEMPerature:LRF?
Example:	:CAL:TEMP:LRF?
Notes:	Value is in degrees Centigrade at which the last successful Align Now, RF was executed, either individually or as a component of Align Now, All.
State Saved:	No
Initial S/W Revision:	Prior to A.02.00
Help Map ID:	0

Key Path:	Visual annotation in the Show Alignment Statistics screen
Mode:	All
Remote Command:	:CALibration:TIME:SOURce:LALL?
Example:	:CAL:TIME:SOUR:LALL?
Notes:	Value is the date and time of the last successful Align Now, Source was performed on the instrument.
State Saved:	No
Initial S/W Revision:	A.05.00

System Functions
System

Help Map ID:	0
--------------	---

Key Path:	Visual annotation in the Show Alignment Statistics screen
Mode:	All
Remote Command:	:CALibration:TEMPerature:SOURce: LALL?
Example:	:CAL:TEMP:SOUR:LALL?
Notes:	Value is in degrees Centigrade at which the last successful Align Now, Source was performed on the instrument.
State Saved:	No
Initial S/W Revision:	A.05.00

Help Map ID:	0
--------------	---

Key Path:	Visual annotation in the Show Alignment Statistics screen
Mode:	All
Remote Command:	:CALibration:TIME:LPreselector?
Example:	:CAL:TIME:LPR?
Notes:	Value is the date and time the last successful Characterize Preselector was executed. The date is separated from the time by a space character. Returns "" if no Characterize Preselector has ever been performed on the instrument.
Dependencies:	In models that do not include preselectors, this command is not enabled and any attempt to set or query will yield an error.
State Saved:	No
Initial S/W Revision:	Prior to A.02.00

Help Map ID:	0
--------------	---

Key Path:	Visual annotation in the Show Alignment Statistics screen
Mode:	All
Remote Command:	:CALibration:TEMPerature:LPreselector?
Example:	:CAL:TEMP:LPR?
Notes:	Value is in degrees Centigrade at which the last successful Characterize Preselector was executed.
Dependencies:	In models that do not include preselectors, this command is not enabled and any attempt to set or query will yield an error.
State Saved:	No
Initial S/W Revision:	Prior to A.02.00

Help Map ID: 0

Key Path:	Visual annotation in the Show Alignment Statistics screen
Mode:	All
Remote Command:	:CALibration:AUTO:TIME:OFF?
Example:	:CAL:AUTO:TIME:OFF?
Notes:	Value is the elapsed time, in seconds, since Auto Align has been set to Off or Off with Alert. The value is 0 if Auto Align is ALL or NORF.
State Saved:	No
Initial S/W Revision:	Prior to A.02.00
Help Map ID:	0

Key Path:	Visual annotation in the Show Alignment Statistics screen
Mode:	All
Remote Command:	:CALibration:TIME:RFPSselector:LCONducted?
Example:	:CAL:TIME:RFPS:LCON?
Notes:	Values are the date and time the last successful Align Now, 20 Hz – 30 MHz was executed. The date is separated from the time by a semi-colon character.
State Saved:	No
Help Map ID:	0

Key Path:	Visual annotation in the Show Alignment Statistics screen
Mode:	All
Remote Command:	:CALibration:TEMPerature:RFPSselector:LCONducted?
Example:	:CAL:TEMP:RFPS:LCON?
Notes:	Value is in degrees Centigrade at which the last successful Align Now, 20 Hz – 30 MHz was executed.
State Saved:	No
Help Map ID:	0

Key Path:	Visual annotation in the Show Alignment Statistics screen
Mode:	All
Remote Command:	:CALibration:TIME:RFPSselector:LRADiated?
Example:	:CAL:TIME:RFPS:LRAD?

System Functions
System

Notes:	Value is the date and time the last successful Align Now, 30 MHz – 3.6 GHz was executed. The date is separated from the time by a semi-colon character.
State Saved:	No
Help Map ID:	0

Key Path:	Visual annotation in the Show Alignment Statistics screen
Mode:	All
Remote Command:	:CALibration:TEMPerature:RFPSelector:LRADiated?
Example:	:CAL:TEMP:RFPS:LRAD?
Notes:	Value is in degrees Centigrade at which the last successful Align Now, 30 MHz – 3.6 GHz was executed.
State Saved:	No
Help Map ID:	0

Key Path:	Visual annotation in the Show Alignment Statistics screen
Mode:	All
Remote Command:	:CALibration:RFPSelector:SCHeduler:TIME:NEXT? This query returns data using the following format “YYYY/MM/DD; HH:MM:SS”
Example:	:CAL:RFPS:SCH:TIME:NEXT?
Notes:	<p>The next run time will be updated based on the start date/time and recurrence set by the users.</p> <p>“date” is representation of the date the task will run in the form of “YYYY/MM/DD” where:</p> <p>YYYY is the four digit representation of year. (for example, 2009)</p> <p>MM is the two digit representation of month. (for example, 01 to 12)</p> <p>DD is the two digit representation of the day. (for example, 01 to 28, 29, 30 or 31 depending on the month and year)</p> <p>“time” is a representation of the time of day the task will run in the form of “HH:MM:SS” where:</p> <p>HH is the two digit representation of the hour in 24 hour format</p> <p>MM is the two digit representation of minute</p> <p>SS is the two digit representation of seconds</p> <p>For model N9038A only.</p>
State Saved:	No
Help Map ID:	0

Restore Align Defaults

Initializes the alignment user interface settings, not alignment data, to the factory default values. Align Now, All must be executed if the value of the Timebase DAC results in a change.

For front panel operation, you are prompted to confirm action before setting the alignment parameters to factory defaults:

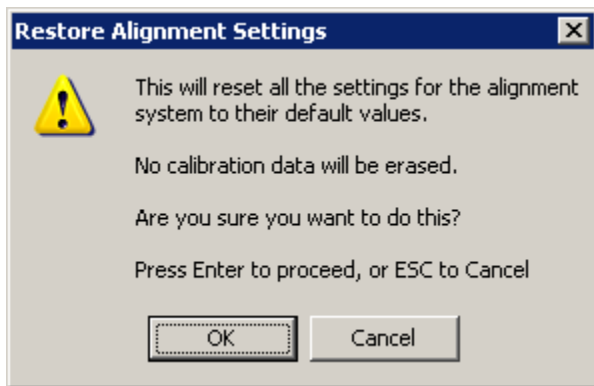

The parameters affected are:

Parameter	Setting
Timebase DAC	Calibrated
Timebase DAC setting	Calibrated value
Auto Align State	Normal (if the instrument is not operating with default alignment data, Off otherwise)
Auto Align All but RF	Off
Auto Align Alert	Time & Temperature

Key Path:	System, Alignments
Mode:	All
Example:	:SYST:DEF ALIG
Notes:	Alignment processing that results as the transition to Auto Alignment Normal will be executed sequentially; thus *OPC? or *WAI will wait until the alignment processing is complete.
Initial S/W Revision:	Prior to A.02.00
Help Map ID:	2022

Backup or Restore Align Data...

Opens the utility for backing-up or restoring the alignment data.

Alignment data for the instrument resides on the hard drive in a database. Agilent uses high quality hard drives; however it is highly recommended the alignment data be backed-up to storage outside of the

System Functions

System

instrument. Additionally, for customers who use multiple CPU Assemblies or multiple disk drives, the alignment that pertains to the instrument must be transferred to the resident hard drive after a CPU or hard drive is replaced. This utility facilitates backing-up and restoring the alignment data.

NOTE This utility allows the operator to navigate to any location of the Windows file system. It is intended that the operator use a USB memory device or Mapped Network Drive to back up the alignment data to storage outside of the instrument.

Key Path:	System, Alignments
Initial S/W Revision:	A.02.00
Help Map ID:	3624

Key Path:	System, Alignments
Mode:	All
Remote Command:	:CALibration:DATA:DEFault
Example:	:CAL:DATA:DEF
Couplings:	Sets Auto Align to Off. Sets bit 14 in the Status Questionable Calibration register. The Error Condition message "Align Now, All required" is generated.
Initial S/W Revision:	Prior to A.02.00
Help Map ID:	0

Alignment Data Wizard

The Backup or Restore Alignment Data wizard guides you through the operation of backing-up or restoring the alignment data.

The following dialogue boxes operate without a mouse or external keyboard when you use the default file names.

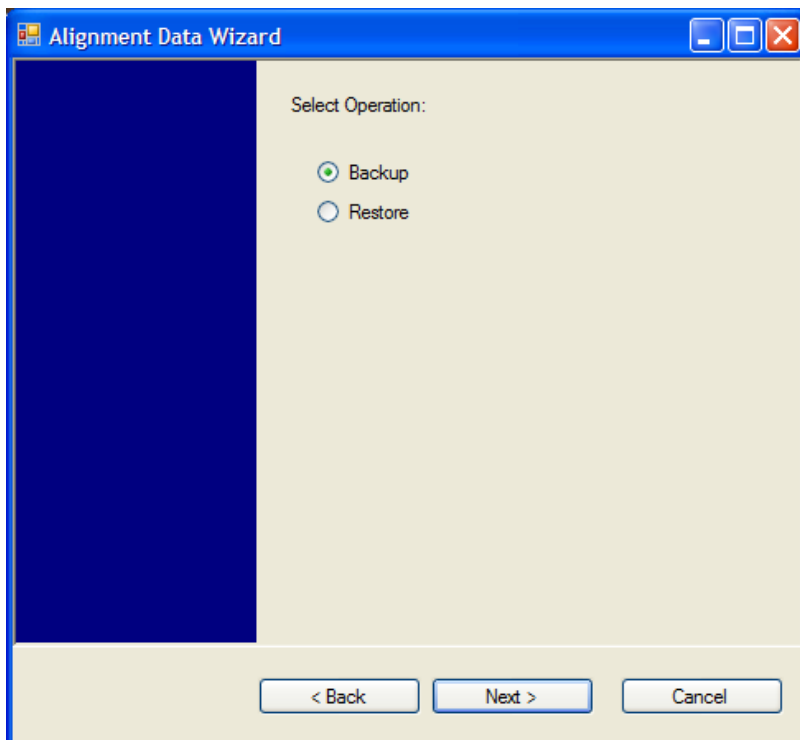
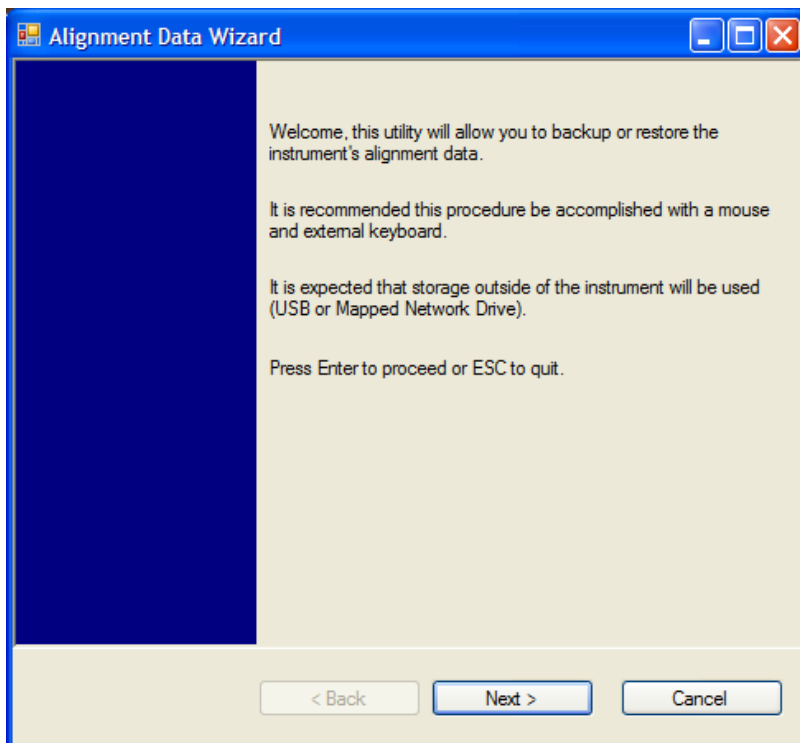

The backup screen indicates the approximate amount of space required to contain the backup file.

The default file name will be AlignDataBackup_<model number>_<serial number>_<date in YYYYMMDDHHMMSS>.bak.

System Functions

System

For the N9030A the default backup location will be the internal F: drive which is a solid-state memory device located internally on the instrument.

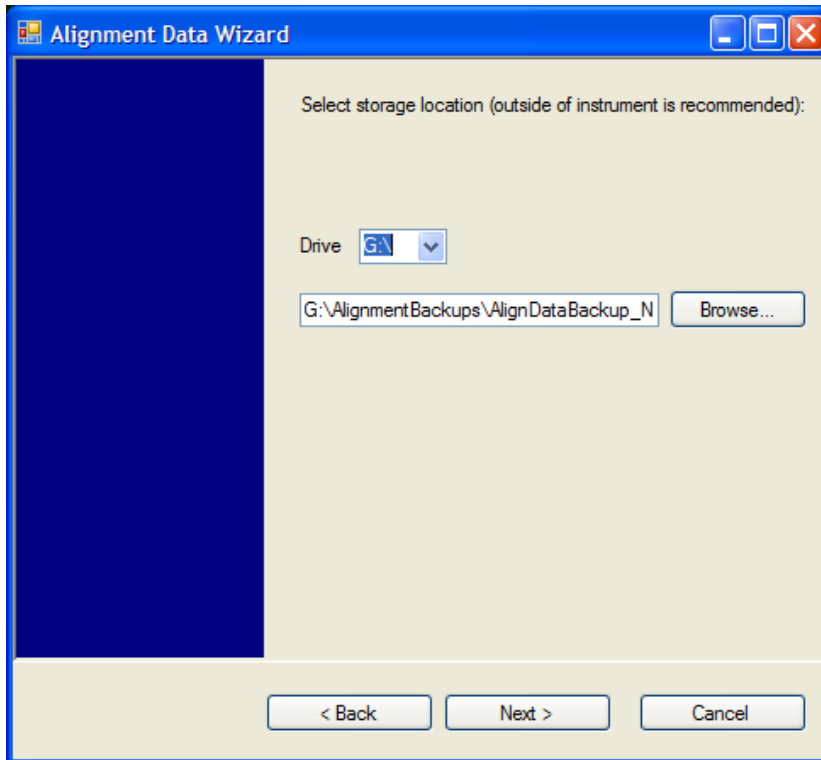

Changing the drive letter will also modify the path displayed in the box below. When this step is first loaded, the drive drop-down menu is populated with connected drives, which provide the user with write access. If there are many unreachable network drives connected to the instrument, this step can take a few seconds. If a USB drive is present, it will be selected by default. The path defaults to the AlignmentBackups folder, and a filename is automatically created in the form of AlignDataBackup_<model>_<serial number>_<date><time>. When the "Next >" button is pressed, you will be prompted to create a new folder if the chosen path does not yet exist.

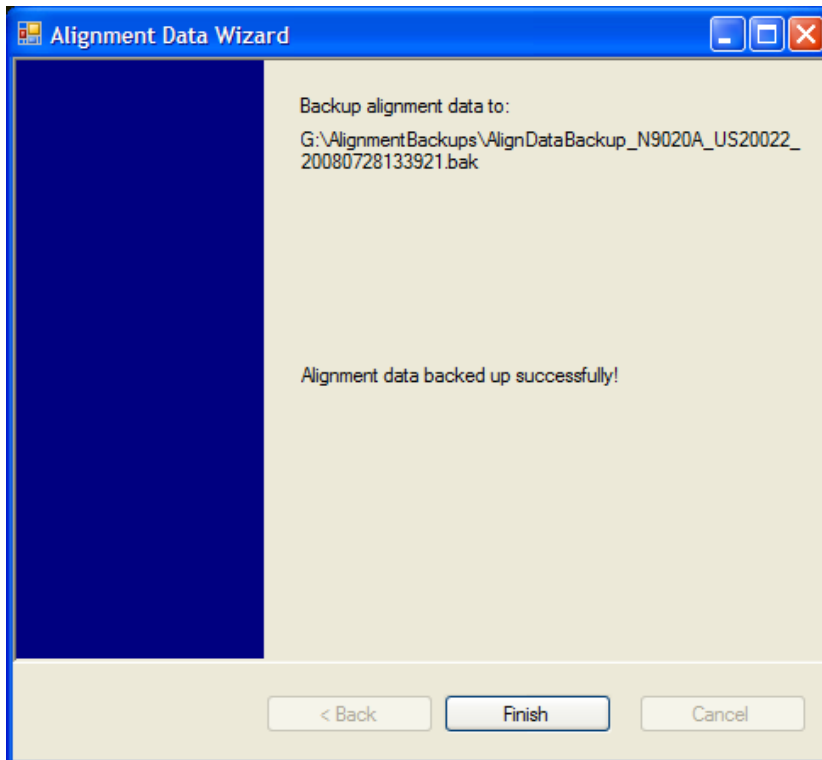
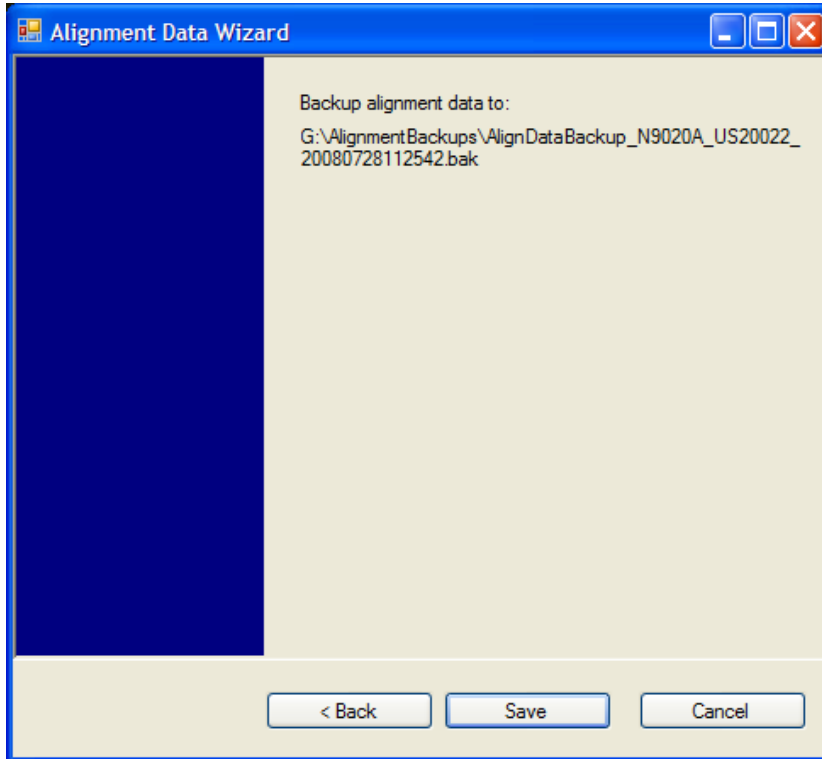

The restore operation checks the validity of the restore file using the database's built-in file validation. If the restore file is corrupt, the existing alignment data will remain in use.

If the serial number information in the backup file being restored is different from that of the instrument,

System Functions

System

the following message appears (the serial number shown are examples):

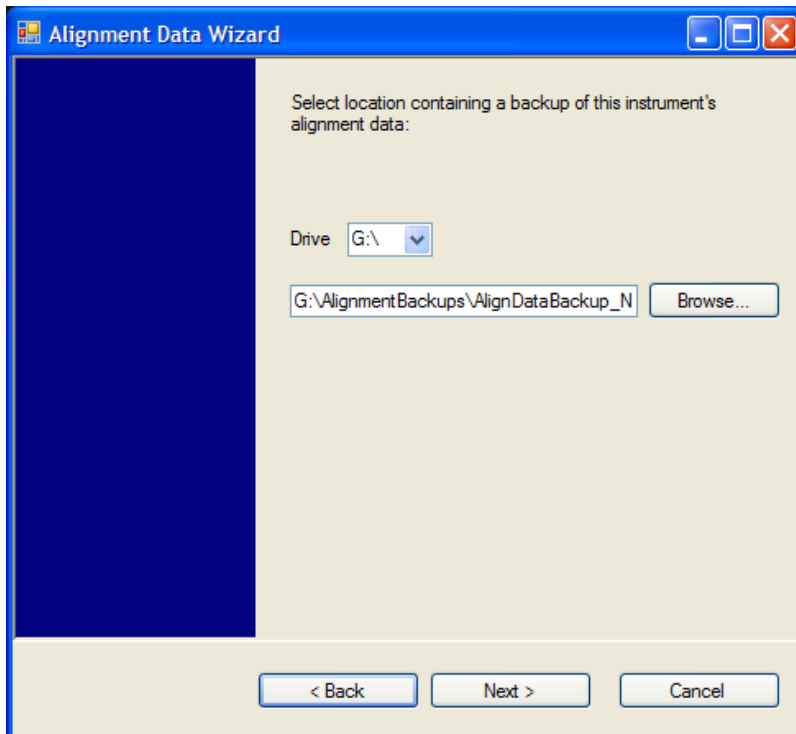
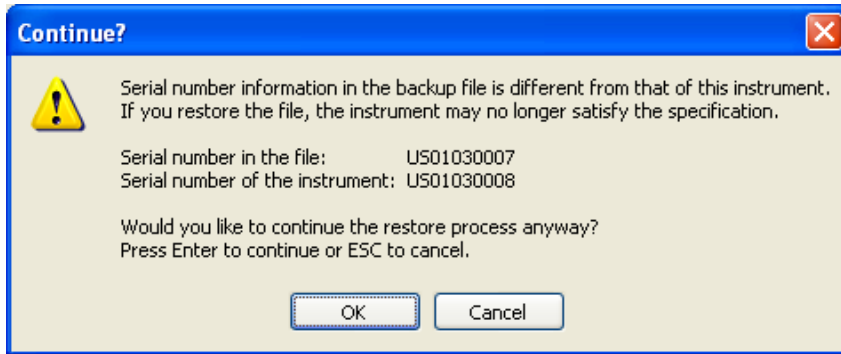

Changing the drive letter also modifies the path displayed in the box below. When this step is first loaded, the drive drop-down menu is populated with connected drives, which provide you with read access. The path defaults to the AlignBackups folder. The most recent *.bak file in the folder will also be selected by default.

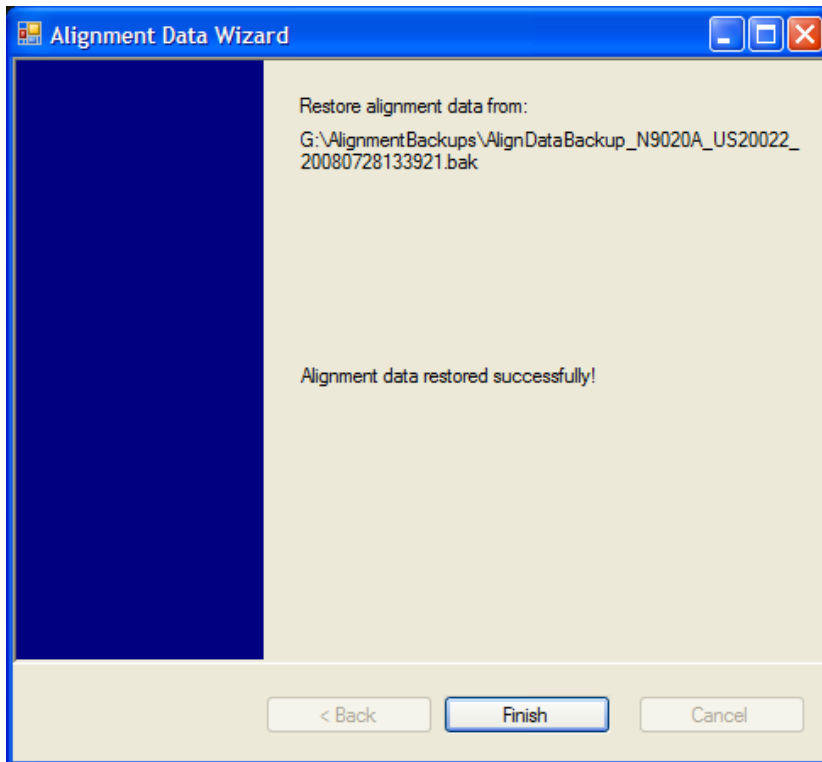
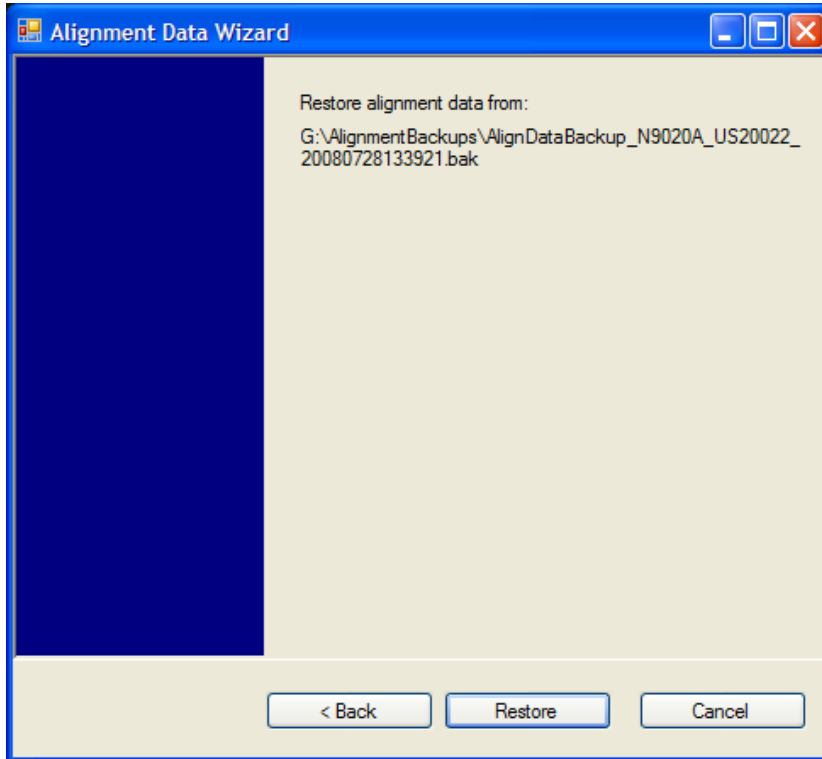

Perform Backup (Remote Command Only)

Invokes an alignment data backup operation to the provided Folder.

NOTE It is recommended that the Folder provided is outside of the instrument (USB or Mapped Network Drive).

Remote Command:	:CALibration:DATA:BACKup <filename>
Example:	:CAL:DATA:BACK "F:\AlignDataBackup_N9020A_US00000001_2008140100.bak"
Initial S/W Revision:	A.02.00
Help Map ID:	0

Perform Restore (Remote Command Only)

Invokes an alignment data restore operation from the provided filename.

Remote Command:	:CALibration:DATA:RESTore <filename>
Example:	:CAL:DATA:REST "F:\ AlignDataBackup_N9020A_US00000001_2008140100.bak "
Initial S/W Revision:	A.02.00
Help Map ID:	0

Advanced

Accesses alignment processes that are immediate action operations that perform operations that run until complete. Advanced alignments are performed on an irregular basis, or require additional operator interaction

Key Path:	System, Alignments
Initial S/W Revision:	Prior to A.02.00
Help Map ID:	2015

Characterize Preselector

The Preselector tuning curve drifts over temperature and time. Recognize that the Amplitude, Presel Center function adjusts the preselector for accurate amplitude measurements at an individual frequency. Characterize Preselector improves the amplitude accuracy by ensuring the Preselector is approximately centered at all frequencies without the use of the Amplitude, Presel Center function. Characterize Preselector can be useful in situations where absolute amplitude accuracy is not of utmost importance, and the throughput savings or convenience of not performing a Presel Center is desired. Presel Center is required prior to any measurement for best (and warranted) amplitude accuracy.

Agilent recommends that the Characterize Preselector operation be performed yearly as part of any calibration, but performing this operation every three months can be worthwhile.

Characterize Preselector immediately executes a characterization of the Preselector, which is a

YIG-tuned filter (YTF). The instrument stops any measurement currently underway, performs the characterization, then restarts the measurement from the beginning (similar to pressing the Restart key).

The query form of the remote commands (:CALibration:YTF?) will invoke the alignment of the YTF subsystem and return a success or failure value.

A failure encountered during alignment will generate the Error Condition message “Characterize Preselector failure” and set bit 3 in the STATUS:QUESTIONable:CALibration:EXTended:FAILure status register. Successful completion of Characterize Preselector will clear this Condition. It will also begin the elapsed time counter for Last Characterize Preselector Time, and capture the Last Characterize Preselector Temperature.

The last Characterize Preselector Time and Temperature survives across the power cycle as this operation is performed infrequently.

NOTE The Characterize Preselector function can be interrupted by pressing the Cancel (ESC) front-panel key or remotely with Device Clear followed by the :ABORt SCPI command. None of the new characterization data is then used. However, since the old characterization data is purged at the beginning of the characterization, you now have an uncharacterized preselector. You should re-execute this function and allow it to finish before making any further preselected measurements.

Key Path:	System, Alignments, Advanced
Mode:	All
Remote Command:	:CALibration:YTF :CALibration:YTF?
Example:	:CAL:YTF
Notes:	:CALibration:YTF? returns 0 if successful :CALibration:YTF? returns 1 if failed (including interfering user signal) While Advanced, Characterize Preselector is performing the alignment, bit 0 in the Status Operation register is set. Completion, or termination, will clear bit 0 in the Status Operation register. This command is sequential; it must complete before further SCPI commands are processed. Interrupting the alignment from remote is accomplished by invoking Device Clear followed by the :ABORt command. Successful completion will clear bit 9 in the Status Questionable Calibration register. A failure encountered during alignment will generate the Error Condition message “Characterize Preselector failed” and set bit 9 in the Status Questionable Calibration register. For Options that support frequencies > 3.6 GHz only.

Dependencies:	This key does not appear in models that do not contain preselectors. In these models the SCPI command is accepted without error but no action is taken.
Couplings:	Initializes the time for the Last Characterize Preselector Time. Records the temperature for the Last Characterize Preselector Temperature.
Initial S/W Revision:	Prior to A.02.00
Help Map ID:	2016

Characterize Multiport Adapter Preamp

A Multiport Adapter Preamp Characterization should be made when MPA and EXT are first paired, a message window is popped up as below to inform the user to take this action:

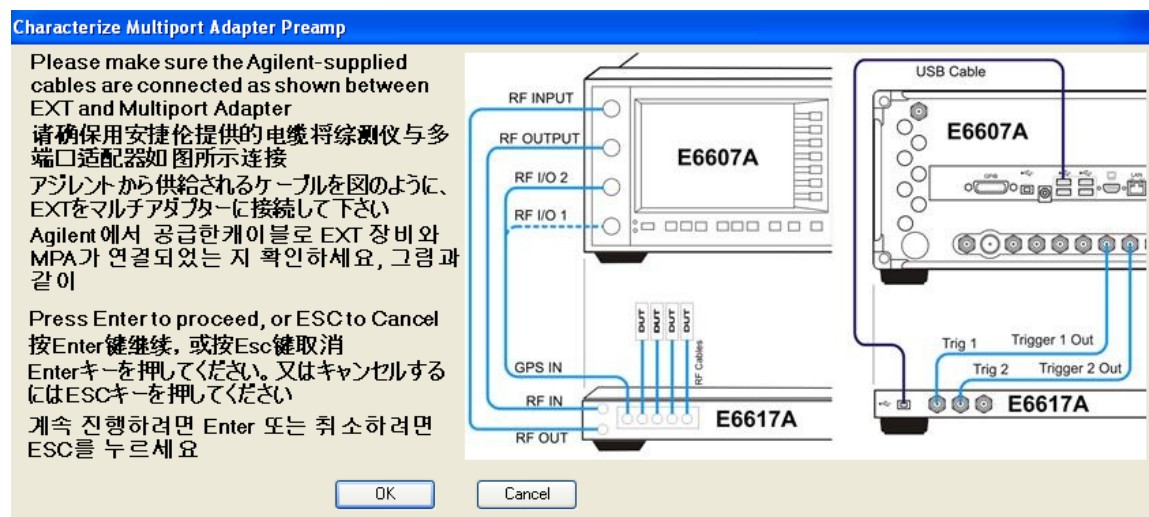

Correspondingly, bit 8 of the STATUS:QUESTIONable:CALibration:EXTended:NEEDED register (error 80) will be set for the “MPA Align required” message. Successful completion of Characterize Multiport Adapter Preamp will clear this Condition.

Users are expected to execute a characterization of the Preamp of Multiport Adapter when it is plugged into the USB port for the first time. The instrument stops any measurement currently underway, performs the characterization, then restarts the measurement from the beginning (similar to pressing the **Restart** key).

The query form of the remote command :CALibration:MPADapter:GAIN? will invoke the characterization of the Preamp of Multiport Adapter and return a success or failure value.

A failure encountered during characterization will generate the Error Condition message “MPA Align failed” and set bit 8 (error 83) in the STATUS:QUESTIONable:CALibration:EXTended:FAILure status register. Successful completion of Characterize Multiport Adapter Preamp will clear this Condition.

NOTE:

NOTE **Characterize Multiport Adapter Preamp** can be interrupted by pressing the Cancel (ESC) front-panel key or remotely with Device Clear followed by the

:ABORt SCPI command.

Key Path:	System, Alignments, Advanced
Mode:	All
Remote Command:	:CALibration:MPADapter:GAIN :CALibration:MPADapter:GAIN?
Example:	:CAL: MPAD:GAIN
Notes:	<p>:CALibration:MPADapter:GAIN? returns 0 if successful</p> <p>:CALibration:MPADapter:GAIN? returns 1 if failed</p> <p>While System, Alignments, Advanced, Characterize Multiport Adapter Preamp is performing the characterization, bit 0 in the Status Operation register is set. Completion, or termination, will clear bit 0 in the Status Operation register.</p> <p>This command is sequential, it must be completed before further SCPI commands are processed. Interrupting the alignment from remote is accomplished by invoking Device Clear followed by the :ABORt command.</p> <p>Successful completion will clear bit 8 in the Status Questionable Calibration Extended Failure register.</p> <p>A failure encountered during alignment will generate the Error Condition message “MPAdapter Preamp Charact Failure” and set bit 8 in the Status Questionable Calibration Extended Failure register.</p>
Dependencies:	This key does not appear unless a multiport adapter is plugged in to the USB. Grayout error: -221.1400; Multiport Adapter Not Available
Status Bits/OPC dependencies:	Bit8 may be set in the Status Questionable Calibration Extended Failure register.
Initial S/W Revision:	A.10.00
Help Map ID:	50010

Timebase DAC

Allows control of the internal 10 MHz reference oscillator timebase. This may be used to adjust for minor frequency alignment between the signal and the internal frequency reference. This adjustment has no effect if the instrument is operating with an External Frequency Reference.

If the value of the Timebase DAC changes (by switching to Calibrated from User with User set to a different value, or in User with a new value entered) an alignment may be necessary. The alignment system will take appropriate action; which will either invoke an alignment or cause an Alert.

Key Path:	System, Alignments
Mode:	All

System Functions
System

Remote Command:	:CALibration:FREQuency:REFerence:MODE CALibrated USER :CALibration:FREQuency:REFerence:MODE?
Example:	:CAL:FREQ:REF:MODE CAL
Notes:	If the value of the timebase is changed the alignment system automatically performs an alignment or alerts that an alignment is due. If the value of the timebase is changed the alignment system automatically performs an alignment or alerts that an alignment is due.
Preset:	This is unaffected by Preset but is set to CALibrated on a “Restore System Defaults->Align”.
State Saved:	No
Initial S/W Revision:	Prior to A.02.00
Help Map ID:	2019

Calibrated

Sets the Timebase DAC to the value established during factory or field calibration. The value displayed on the menu key is the calibrated value.

Key Path:	System, Alignments, Timebase DAC
Mode:	All
Example:	:CAL:FREQ:REF:MODE CAL
Readback Text:	[xxx] < where xxx is the calibrated value
Initial S/W Revision:	Prior to A.02.00
Help Map ID:	2020

User

Allows setting the Timebase DAC to a value other than the value established during the factory or field calibration. The value displayed on the menu key is the calibrated value.

Key Path:	System, Alignments, Timebase DAC
Mode:	All
Example:	:CAL:FREQ:REF:MODE USER
Readback Text:	xxx < where xxx is the Timebase DAC setting
Initial S/W Revision:	Prior to A.02.00
Help Map ID:	2021

Key Path:	System, Alignments, Timebase DAC
Mode:	All

Remote Command:	:CALibration:FREQuency:REFErence:FINE <integer> :CALibration:FREQuency:REFErence:FINE?
Example:	:CAL:FREQ:REF:FINE 8191
Notes:	If the value of the timebase is changed the alignment system automatically performs an alignment or alerts that an alignment is due.
Couplings:	Setting :CAL:FREQ:REF:FINE sets :CAL:FREQ:REF:MODE USER
Preset:	This is unaffected by Preset but is set to the factory setting on a “Restore System Defaults->Align”.
State Saved:	No
Min:	0
Max:	16383
Backwards Compatibility SCPI:	:CALibration:FREQuency:REFErence:COARse ESA hardware contained two DAC controls for the Timebase. In X-Series the command :CALibration:FREQuency:REFErence:FINE is the method for adjusting the timebase. The :COARse command is provided as an alias to :FINE.
Initial S/W Revision:	Prior to A.02.00
Help Map ID:	0

Remote Command:	:CALibration:FREQuency:REFErence:COARse <integer> :CALibration:FREQuency:REFErence:COARse?
Example:	:CAL:FREQ:REF:COAR 8191
Notes:	This is an alias for CAL:FREQ:REF:FINE any change to COARse is reflected in FINE and vice-versa. See CAL:FREQ:REF:FINE for description of functionality.
Couplings:	Setting :CAL:FREQ:REF:COAR sets :CAL:FREQ:REF:MODE USER
Initial S/W Revision:	Prior to A.02.00
Help Map ID:	0

RF Preselector

This menu and all of its submenus are only available in models with the RF Preselector, such as the N9038A.

See [“Align Now, 20 Hz to 30 MHz” on page 288](#)

See [“Align Now, 30 MHz to 3.6 GHz” on page 289](#)

See [“Align Now, 20 Hz to 3.6 GHz” on page 291](#)

See “Alert” on page 292

Key Path:	System, Alignments
Initial S/W Revision:	Prior to A.08..00
Help Map ID:	3694

Align Now, 20 Hz to 30 MHz

Immediately executes an alignment of the receiver subsystem. The receiver will stop any measurement currently underway, perform the alignment, and then restart the measurement from the beginning (similar to pressing the Restart key).

The query form of the remote commands (:CALibration:RFPSelector:CONDUCTed?) will invoke the alignment of the RF Preselector on Conducted Band and return a success or failure value. Successful completion will clear the “Align 20 Hz to 30 MHz required” Error Condition, and clear the bit 1 in the Status Questionable Calibration Extended Needed register. The elapsed time counter will begin for Last Align Now, Conducted Time, and the temperature is captured for the Last Align Now, Conducted Temperature. The alignment can be interrupted by pressing the Cancel (ESC) front-panel key or remotely with Device Clear followed by the :ABORT SCPI command. When this occurs, the Error Condition “Align 20 Hz to 30 MHz required” is set because new alignment data may be employed for an individual subsystem, but not a cohesive set of data for all subsystems.

The “Align 20 Hz to 30 MHz required” Error Condition will appear when this alignment has expired. User is now responsible to perform the Align Now, 20 Hz to 30 MHz in order to keep the receiver in warranted operation. This alignment can only be performed by user as it is not part of the Auto Align process.

Key Path:	System, Alignments, RF Preselector, Align Now
Mode:	All
Remote Command:	:CALibration:RFPSelector:CONDUCTed :CALibration:RFPSelector:CONDUCTed?
Example:	:CAL:RFPS:COND

Notes:	<p>:CALibration:RFPSelector:CONDucted? Return 0 if successful</p> <p>:CALibration:RFPSelector:CONDucted? Return 1 if failed</p> <p>When Align 20 Hz to 30 MHz is performing the alignment, bit 0 in the Status Operation register is set. Completion, or termination, will clear bit 0 in the Status Operation register.</p> <p>This command is sequential; it must complete before further SCPI commands are processed. Interrupting the alignment from remote is accomplished by invoking Device Clear followed by the :ABORt command. Successful completion will clear bit 1 in the Status Questionable Calibration Extended Needed register and bit 0 in Status Questionable Calibration Extended Failure register.</p> <p>A failure encountered during alignment will set the Error Condition “20 Hz to 30 MHz Alignment Failure” and set both bit 1 in the Status Questionable Calibration Extended Needed register and bit 9 in Status Questionable Calibration register.</p> <p>For model N9038A only.</p>
Dependencies:	This key does not appear in other than N9038A models, setting or querying the SCPI will generate an error.
Couplings:	<p>Initializes the time for the Last Align Conducted Now, Conducted Time.</p> <p>Records the temperature for the Last Align Conducted Now, Conducted Temperature.</p>
Status Bits/OPC Dependencies:	<p>Bit 8 or 9 may be set in the Status Questionable Calibration register.</p> <p>Bit 1 may be set in the Status Questionable Calibration Extended Needed register.</p> <p>Bit 0 may be set in the Status Questionable Calibration Extended Failure register.</p>
Initial S/W Revision:	A.08.00
Help Map ID:	3673

Align Now, 30 MHz to 3.6 GHz

Immediately executes an alignment of the receiver subsystem. The receiver will stop any measurement currently underway, perform the alignment, and then restart the measurement from the beginning (similar to pressing the Restart key).

The query form of the remote commands (:CALibration:RFPSelector:RADiated?) will invoke the alignment of the RF Preselector on Radiated Band and return a success or failure value. Successful completion will clear the “Align 30 MHz to 3.6 GHz required” Error Condition, and clear the bit 2 in the Status Questionable Calibration Extended Needed register. The elapsed time counter will begin for Last Align Now, Radiated Time, and the temperature is captured for the Last Align Now, Radiated Temperature. The alignment can be interrupted by pressing the Cancel (ESC) front-panel key or remotely with Device Clear followed by the :ABORt SCPI command. When this occurs, the Error Condition “Align 30 MHz to 3.6 GHz required” is set because new alignment data may be employed for an individual subsystem, but not a cohesive set of data for all subsystems.

System Functions
System

The “Align 30 MHz to 3.6 GHz required” Error Condition will appear when this alignment has expired. User is now responsible to perform the Align Now, 30 MHz to 3.6 GHz in order to keep the receiver in warranted operation. This alignment can only be performed by user as it is not part of the Auto Align process.

Key Path:	System, Alignments, RF Preselector, Align Now
Mode:	All
Remote Command:	:CALibration:RFPreselector:RADiated :CALibration:RFPreselector:RADiated?
Example:	:CAL:RFPS:RAD
Notes:	:CALibration:RFPreselector:RADiated? Return 0 if successful :CALibration:RFPreselector:RADiated? Return 1 if failed When Align 30 MHz to 3.6 GHz is performing the alignment, bit 0 in the Status Operation register is set. Completion, or termination, will clear bit 0 in the Status Operation register. This command is sequential; it must complete before further SCPI commands are processed. Interrupting the alignment from remote is accomplished by invoking Device Clear followed by the :ABORT command. Successful completion will clear bit 2 in the Status Questionable Calibration Extended Needed register and bit 1 in Status Questionable Calibration Extended Failure register. A failure encountered during alignment will set the Error Condition “30 MHz to 3.6 GHz Alignment Failure” and set both bit 2 in the Status Questionable Calibration Extended Needed register and bit 9 in Status Questionable Calibration register. For model N9038A only.
Dependencies:	This key does not appear in other than N9038A models, setting or querying the SCPI will generate an error.
Couplings:	Initializes the time for the Last Align Radiated Now, Radiated Time. Records the temperature for the Last Align Radiated Now, Radiated Temperature.
Status Bits/OPC Dependencies:	Bit 8 or 9 may be set in the Status Questionable Calibration register. Bit 2 may be set in the Status Questionable Calibration Extended Needed register. Bit 1 may be set in the Status Questionable Calibration Extended Failure register.
Initial S/W Revision:	A.08.00
Help Map ID:	3674

Align Now, 20 Hz to 3.6 GHz

Immediately executes an alignment of the receiver subsystem. The receiver will stop any measurement currently underway, perform the alignment, and then restart the measurement from the beginning (similar to pressing the Restart key).

The query form of the remote commands (:CALibration:RFPSelector:FULL?) will invoke the alignment of the RF Preselector on both Conducted and Radiated Band and return a success or failure value. Successful completion will clear the “Align 20 Hz to 3.6 GHz required” Error Condition, and clear the bit 1 and bit 2 in the Status Questionable Calibration Extended Needed register. The elapsed time counter will begin for Last Align Now, Conducted Time and Last Align Now Radiated Time and the temperature is captured for Last Align Now, Conducted Temperature and Last Align Now, Radiated Temperature. The alignment can be interrupted by pressing the Cancel (ESC) front-panel key or remotely with Device Clear followed by the :ABORt SCPI command. When this occurs, the Error Condition “Align 20 Hz to 3.6 GHz required” is set because new alignment data may be employed for an individual subsystem, but not a cohesive set of data for all subsystems.

The “Align 20 Hz to 3.6 GHz required” Error Condition will appear when this alignment has expired. User is now responsible to perform the Align Now, 20 Hz to 3.6 GHz in order to keep the receiver in warranted operation. This alignment can only be performed by user as it is not part of the Auto Align process.

Key Path:	System, Alignments, RF Preselector, Align Now
Mode:	All
Remote Command:	:CALibration:RFPSelector:FULL :CALibration:RFPSelector:FULL?
Example:	:CAL:RFPS:FULL
Notes:	:CALibration:RFPSelector:FULL? Return 0 if successful :CALibration:RFPSelector:FULL? Return 1 if failed When Align 20 Hz to 3.6 GHz is performing the alignment, bit 0 in the Status Operation register is set. Completion, or termination, will clear bit 0 in the Status Operation register. This command is sequential; it must complete before further SCPI commands are processed. Interrupting the alignment from remote is accomplished by invoking Device Clear followed by the :ABORt command. Successful completion will clear bit 1, bit 2 in the Status Questionable Calibration Extended Needed register and bit 0, bit 1 in Status Questionable Calibration Extended Failure register. A failure encountered during alignment will set the Error Condition “20 Hz to 3.6 GHz Alignment Failure” and set bit1, bit 2 in the Status Questionable Calibration Extended Needed register and bit 9 in Status Questionable Calibration register. For model N9038A only.
Dependencies:	This key does not appear in other than N9038A models, setting or querying the SCPI will generate an error.

System Functions
System

Couplings:	<p>Initializes the time for the Last Align Conducted Now, Conducted Time.</p> <p>Initializes the time for the Last Align Radiated Now, Radiated Time.</p> <p>Records the temperature for the Last Align Conducted Now, Conducted Temperature.</p> <p>Records the temperature for the Last Align Radiated Now, Radiated Temperature.</p>
Status Bits/OPC Dependencies:	<p>Bit 8 or 9 may be set in the Status Questionable Calibration register.</p> <p>Bit 1 and 2 may be set in the Status Questionable Calibration Extended Needed register.</p> <p>Bit 0 and 1 may be set in the Status Questionable Calibration Extended Failure register.</p>
Initial S/W Revision:	A.08.00
Help Map ID:	3675

Alert

Setting Alert to ON/OFF will enable/disable the display of RF Preselector alignment required message on the status line. The instrument will power up with Alert On mode.

Key Path:	System, Alignments, RF Preselector
Mode:	All
Remote Command:	:CALibration:RFPSelector:ALERT ON OFF 0 1 :CALibration:RFPSelector:ALERT?
Example:	:CAL:RFPS:ALER OFF
Notes:	<p>For model N9038A only.</p> <p>Error Condition will be generated when the alert is On and any of the RF Preselector alignments has expired.</p>
Preset:	This is unaffected by Preset, but is set to ON on a “Restore System Defaults->Align”.
State Saved:	No
Initial S/W Revision:	A.08.00
Help Map ID:	3676

Schedule Setup

Enables you to schedule a task to run automatically at the background based on the recurrence and time set in the scheduler. Make sure that the Instrument’s local time is accurate as the Scheduler relies on this information to execute the task.

Key Path:	System, Alignments, RF Preselector
-----------	---

Initial S/W Revision:	A.08.00
Help Map ID:	3677

Task

There are 3 task that can be selected for the scheduler to run.

Task 1 is the 20 Hz to 30 MHz alignment

Task 2 is the 30 MHz to 3.6 GHz alignment

Task 3 is the 20 Hz to 3.6 GHz alignment.

Key Path:	System, Alignments, RF Preselector, Schedule Setup
Mode:	All
Remote Command:	:CALibration:RFPSselector:SCHeduler:TASK T1 T2 T3 :CALibration:RFPSselector:SCHeduler:TASK?
Example:	:CAL:RFPS:SCH:TASK T1
Notes:	Changing the task will not reset the Scheduler time and the alignment is based on the current scheduled configuration to occur. For model N9038A only.
Preset:	This is unaffected by Preset but is set to T3 on a "Restore System Defaults->Align".
State Saved:	No
Range:	Task 1 Task 2 Task 3
Initial S/W Revision:	A.08.00
Help Map ID:	3678

Date/Time

Enables you to configure the scheduler to run a task starting from this date and time. The date and time rely on the instrument's local time to execute a scheduled task. The date is based on the format "YYYY/MM/DD" and the time is based on a 24 hour clock.

Key Path:	System, Alignments, RF Preselector, Schedule Setup
Mode:	All
Remote Command:	:CALibration:RFPSselector:SCHeduler:TIME:START "date", "time" :CALibration:RFPSselector:SCHeduler:TIME:START? This query returns data using the following format "YYYY/MM/DD; HH:MM:SS"
Example:	:CAL:RFPS:SCH:TIME:STAR "2009/8/20","12:00:00"

System Functions
System

Notes:	<p>“date” is representation of the date the task will run in the form of “YYYY/MM/DD” where:</p> <p>YYYY is the four digit representation of year. (for example, 2009)</p> <p>MM is the two digit representation of month. (for example, 01 to 12)</p> <p>DD is the two digit representation of the day. (for example, 01 to 28, 29, 30 or 31 depending on the month and year)</p> <p>“time” is a representation of the time of day the task will run in the form of “HH:MM:SS” where:</p> <p>HH is the two digit representation of the hour in 24 hour format</p> <p>MM is the two digit representation of minute</p> <p>SS is the two digit representation of seconds</p> <p>For model N9038A only.</p>
Preset:	This is unaffected by Preset but is set to Current date and 00:00:00 on a “Restore System Defaults->Align”.
State Saved:	No
Initial S/W Revision:	A.08.00
Help Map ID:	3679

Date

Enables you to configure the date of the scheduled task. The SCPI command to configure the date and time parameters of the scheduler is the same; however, they each have their own front-panel control.

Key Path:	System, Alignments, RF Preselector, Schedule Setup, Date/Time
Notes:	<p>See “Date/Time ” on page 293.</p> <p>For model N9038A only.</p>
Preset:	This is unaffected by Preset but is set to Current date and 00:00:00 on a “Restore System Defaults->Align”.
State Saved:	No
Initial S/W Revision:	A.08.00
Help Map ID:	3680

Time

Enables you to configure the time of the scheduled task. The SCPI command to configure the date and time parameters of the scheduler is the same; however, they each have their own front panel-control.

Key Path:	System, Alignments, RF Preselector, Schedule Setup, Date/Time
Notes:	<p>See “Date/Time ” on page 293 .</p> <p>For model N9038A only.</p>

Preset:	This is unaffected by Preset but is set to Current date and 00:00:00 on a “Restore System Defaults->Align”.
State Saved:	No
Initial S/W Revision:	A.08.00
Help Map ID:	3681

Recurrence

Enables you to configure the scheduler to run the task recurrently on a scheduled date and time. You can schedule it to run daily, weekly or alternate weeks.

Key Path:	System, Alignments, RF Preselector, Schedule Setup
Mode:	All
Remote Command:	:CALibration:RFPSelector:SCHeduler:RECurrence DAY WEEK OFF :CALibration:RFPSelector:SCHeduler:RECurrence?
Example:	:CAL:RFPS:SCH:REC DAY
Notes:	For model N9038A only.
Preset:	This is unaffected by Preset but is set to OFF on a “Restore System Defaults->Align”.
State Saved:	No
Range:	DAY WEEK OFF
Initial S/W Revision:	A.08.00
Help Map ID:	3682

Every N Weeks

Enables you to configure the scheduler to run the task on a day in every number of week’s duration.

Key Path:	System, Alignments, RF Preselector, Schedule Setup, Recurrence
Initial S/W Revision:	A.08.00
Help Map ID:	3683

N of Weeks

Enables you to set the number of weeks that the scheduler will wait to trigger a task.

Key Path:	System, Alignments, RF Preselector, Schedule Setup, Recurrence, Every N Weeks
Mode:	All

System Functions
System

Remote Command:	:CALibration:RFPSelector:Scheduler:REcurrence:WEEK <integer> :CALibration:RFPSelector:Scheduler:REcurrence:WEEK?
Example:	:CAL:RFPS:SCH:REC:WEEK 2
Notes:	New scheduled date to run the alignment task will get updated when this parameter is changed. For model N9038A only.
Preset:	This is unaffected by Preset but is set to 1 on a “Restore System Defaults->Align”.
State Saved:	No
Range:	1–52
Initial S/W Revision:	A.08.00
Help Map ID:	3684

Day

Enables you to set the Day of the Week the scheduler will run a scheduled task.

Key Path:	System, Alignments, RF Preselector, Schedule Setup, Recurrence, Every N Weeks
Mode:	All
Remote Command:	:CALibration:RFPSelector:Scheduler:REcurrence:DAY SUN MON TUE WED THU FRI SAT :CALibration:RFPSelector:Scheduler:REcurrence:DAY?
Example:	:CAL:RFPS:SCH:REC:DAY SUN
Notes:	For model N9038A only.
Preset:	This is unaffected by Preset but is set to SUN on a “Restore System Defaults->Align”.
State Saved:	No
Range:	Sunday Monday Tuesday Wednesday Thursday Friday Saturday
Initial S/W Revision:	A.08.00
Help Map ID:	3685

Scheduler

Setting the Scheduler to ON will trigger the execution of the scheduled task based on the recurrence and time set in the scheduler since the last successful of the specific alignment. A warning condition of “RF Preselector alignment scheduler is ON” will be appeared when the scheduler is set to ON. OFF will turn off the Scheduler from running any scheduled task.

Key Path:	System, Alignments, RF Preselector
-----------	---

Mode:	All
Remote Command:	:CALibration:RFPSelector:SCHeduler:STATe ON OFF 0 1 :CALibration:RFPSelector:SCHeduler:STATe?
Example:	:CAL:RFPS:SCH:STAT OFF
Notes:	For model N9038A only.
Preset:	This is unaffected by Preset but is set to OFF on a “Restore System Defaults->Align”.
State Saved:	No
Initial S/W Revision:	A.08.00
Help Map ID:	3686

I/O Config

Activates a menu for identifying and changing the I/O configuration for remote control.

Key Path:	System
Initial S/W Revision:	Prior to A.02.00
Help Map ID:	2100

GPIB

Activates a menu for configuring the GPIB I/O port.

Key Path:	System, I/O Config
Initial S/W Revision:	A.02.00
Help Map ID:	3625

GPIB Address

Select the GPIB remote address.

Key Path:	System, I/O Config, GPIB
Mode:	All
Remote Command:	:SYSTem:COMMunicate:GPIB [1] [:SELF] :ADDRess <integer> :SYSTem:COMMunicate:GPIB [1] [:SELF] :ADDRess?
Example:	:SYST:COMM:GPIB:ADDR 17
Notes:	Changing the Address on the GPIB port requires all further communication to use the new address.

Preset:	This is unaffected by Preset but is set to 18 on a “Restore System Defaults->Misc”
State Saved:	No
Range:	0 to 30
Initial S/W Revision:	Prior to A.02.00
Help Map ID:	2101

GPIB Controller

Sets the GPIB port into controller or device mode. In the normal state, GPIB controller is disabled, which allows the analyzer to be controlled by a remote computer. When GPIB Controller is enabled, the instrument can run software applications that use the instrument's computer as a GPIB controller; controlling devices connected to the instrument's GPIB port.

NOTE When GPIB Controller is enabled, the analyzer application itself cannot be controlled over GPIB. In this case it can easily be controlled via LAN or USB. The GPIB port cannot be a controller and device at the same time. Only one controller can be active on the GPIB bus at any given time. If the analyzer is the controller, an external PC cannot be a controller.

To control the instrument from the software that is performing GPIB controller operation, you can use an internal TCP/IP connection to the analyzer application. Use the address TCPIP0:localhost:inst0:INSTR to send SCPI commands to the analyzer application.

Key Path:	System, I/O Config, GPIB
Mode:	All
Scope:	Mode Global
Remote Command:	:SYSTem:COMMunicate:GPIB[1] [:SELF] :CONTroller[:ENABLE] ON OFF 0 1 :SYSTem:COMMunicate:GPIB[1] [:SELF] :CONTroller[:ENABLE] ?
Example:	:SYST:COMM:GPIB:CONT ON Will set GPIB port to Controller
Notes:	When the instrument becomes the Controller bit 0 in the Standard Event Status Register is set (and when the instrument relinquishes Controller capability bit 0 is cleared in the Standard Event Status Register).
Preset:	This is unaffected by Preset but is set to OFF on a “Restore System Defaults->Misc”
State Saved:	No
Range:	Disabled Enabled
Initial S/W Revision:	A.02.00
Help Map ID:	3626

Disabled

Disables the GPIB Controller capability, this is the default (or normal) setting.

Key Path:	System, I/O Config, GPIB, GPIB Controller
Example:	:SYST:COMM:GPIB:CONT OFF Will set GPIB port to Device
Initial S/W Revision:	A.02.00
Help Map ID:	3627

Enabled

Enables the GPIB Controller capability.

Key Path:	System, I/O Config, GPIB, GPIB Controller
Example:	:SYST:COMM:GPIB:CONT ON Will set GPIB port to Controller
Initial S/W Revision:	A.02.00
Help Map ID:	3628

SCPI LAN

Activates a menu for identifying and changing the SCPI over a LAN configuration. There are a number of different ways to send SCPI remote commands to the instrument over LAN. It can be a problem to have multiple users simultaneously accessing the instrument over the LAN. These keys limit that somewhat by disabling the telnet, socket, and/or SICL capability.

Key Path:	System, I/O Config
Initial S/W Revision:	Prior to A.02.00
Help Map ID:	2102

SCPI Telnet

Turns the SCPI LAN telnet capability On or Off allowing you to limit SCPI access over LAN through telnet.

Key Path:	System, I/O Config, SCPI LAN
Mode:	All
Remote Command:	:SYSTem:COMMunicate:LAN:SCPI:TELNet:ENABle OFF ON 0 1 :SYSTem:COMMunicate:LAN:SCPI:TELNet:ENABle?
Example:	:SYST:COMM:LAN:SCPI:TELN:ENAB OFF
Preset:	This is unaffected by Preset but is set to ON with a "Restore System Defaults->Misc"
State Saved:	No

System Functions
System

Range:	On Off
Initial S/W Revision:	Prior to A.02.00
Help Map ID:	2103

SCPI Socket

Turns the capability of establishing Socket LAN sessions On or Off. This allows you to limit SCPI access over LAN through socket sessions.

Key Path:	System, I/O Config, SCPI LAN
Mode:	All
Remote Command:	:SYSTem:COMMunicate:LAN:SCPI:SOCKet:ENABle OFF ON 0 1 :SYSTem:COMMunicate:LAN:SCPI:SOCKet:ENABle?
Example:	:SYST:COMM:LAN:SCPI:SOCK:ENAB OFF
Preset:	This is unaffected by a Preset but is set to ON with a “Restore System Defaults->Misc”
State Saved:	No
Range:	On Off
Initial S/W Revision:	Prior to A.02.00
Help Map ID:	2104

SICL Server

Turns the SICL server capability On or Off, enabling you to limit SCPI access over LAN through the SICL server. (SICL IEEE 488.2 protocol.)

Parameter	Description	Setting
Maximum Connections	The maximum number of connections that can be accessed simultaneously	5
Instrument Name	The name (same as the remote SICL address) of your analyzer	inst0
Instrument Logical Unit	The unique integer assigned to your analyzer when using SICL LAN	8
Emulated GPIB Name	The name (same as the remote SICL address) of the device used when communicating with your analyzer	gpib7
Emulated GPIB Logical Unit	The unique integer assigned to your device when it is being controlled using SICL LAN	8
Emulated GPIB Address	The emulated GPIB address assigned to your transmitter tester when it is a SICL server (the same as your GPIB address)	18

Key Path:	System, I/O Config, SCPI LAN
Mode:	All
Remote Command:	:SYSTem:COMMunicate:LAN:SCPI:SIcL:ENABle OFF ON 0 1 :SYSTem:COMMunicate:LAN:SCPI:SIcL:ENABle?
Example:	:SYST:COMM:LAN:SCPI:SIcL:ENAB OFF
Preset:	This is unaffected by Preset, but is set to ON with a “Restore System Defaults->Misc”
State Saved:	No
Range:	On Off
Initial S/W Revision:	Prior to A.02.00
Help Map ID:	2106

HiSLIP Server

Turns the HiSLIP server capability On or Off, enabling you to limit SCPI access over LAN through the HiSLIP server.

HiSLIP stands for High Speed LAN Instrument Protocol and is part of the IVI-6.1 specification.

Here is an example of a VISA connection string used to connect to the HiSLIP Server on an X-Series Spectrum Analyzer:

TCPIP0::a-n9030a-93016::hislip0::INSTR

In the example above, hislip0 is the HiSLIP device name that VISA users must include in their HiSLIP VISA Address strings. Your HiSLIP device name may be different depending on your VISA settings.

Key Path:	System, I/O Config, SCPI LAN
Mode:	All
Remote Command:	:SYSTem:COMMunicate:LAN:SCPI:HISLip:ENABle OFF ON 0 1 :SYSTem:COMMunicate:LAN:SCPI:HISLip:ENABle?
Example:	:SYST:COMM:LAN:SCPI:HISL:ENAB OFF
Preset:	This is unaffected by Preset, but is set to ON with a “Restore System Defaults->Misc”
State Saved:	No
Range:	On Off
Initial S/W Revision:	A.11.00
Help Map ID:	50007

SCPI Socket Control Port (Remote Command Only)

Returns the TCP/IP port number of the control socket associated with the SCPI socket session. This

System Functions
System

query enables you to obtain the unique port number to open when a device clear is to be sent to the instrument. Every time a connection is made to the SCPI socket, the instrument creates a peer control socket. The port number for this socket is random. The user must use this command to obtain the port number of the control socket. To force a device clear on this socket, open the port and send the string “DCL ” to the instrument.

If this SCPI command is sent to a non SCPI Socket interface, then 0 is returned.

Mode:	All
Remote Command:	:SYSTem:COMMunicate:LAN:SCPI:SOCKet:CONTrol?
Example:	:SYST:COMM:LAN:SCPI:SOCK:CONT?
Preset:	This is unaffected by Preset or “Restore System Defaults->Misc”.
State Saved:	No
Range:	0 to 65534
Initial S/W Revision:	Prior to A.02.00
Help Map ID:	0

Reset Web Password

The embedded web server contains certain capability which are password protected; modifying the LAN configuration of the instrument, and access to web pages that can change the settings of the instrument. The default password from the factory is ‘agilent’ (without the quotes). The control provided here is the means to set the web password as the user desires, or to reset the password to the factory default.

Selecting Reset web password brings up a control for resetting the password as the user desires, or to the factory default. A keyboard is required to change the password from the factory default of ‘agilent’ or to set a new password that contains alphabetic characters. The control is:

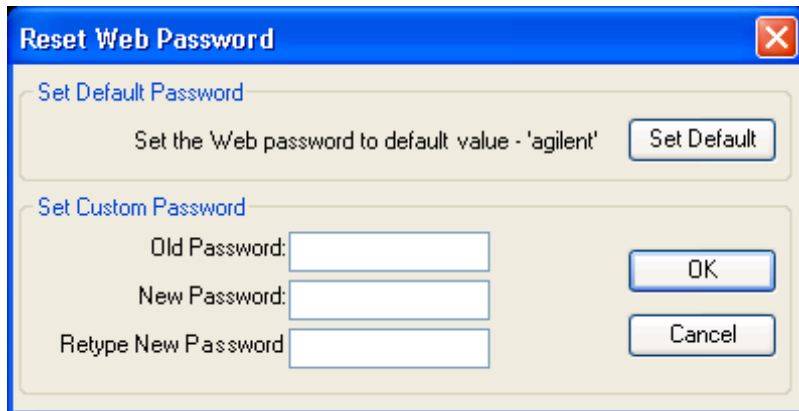

If this control is entered without an external keyboard or mouse connected, you can cancel the control by pressing the Cancel (ESC) front-panel key.

Key Path:	System, I/O Config
Mode:	All

Initial S/W Revision:	Prior to A.02.00
Help Map ID:	3600

LXI

Opens a menu that allows you to access the various LXI configuration properties.

Key Path:	System, I/O Config
Initial S/W Revision:	Prior to A.02.00
Help Map ID:	3606

LAN Reset

Resets the LAN connection.

Key Path:	System, I/O Config, LXI
Initial S/W Revision:	Prior to A.02.00
Help Map ID:	3500

System IDN Response

This key allows you to specify a response to the *IDN? query, or to return the analyzer to the Factory response if you have changed it.

To choose the factory-set response, press the **Factory** key.

To specify your own response, press the **User** key, and enter your desired response.

Key Path:	System, I/O Config
Mode:	All
Remote Command:	:SYSTem:IDN <string> :SYSTem:IDN?
Notes:	This affects the response given in all Modes of the Analyzer, unless the current Mode has also specified a custom response, in which case the current Mode's custom IDN response takes precedence over the System's, but only while that Mode is the current Mode.. It survives shutdown and restart of the software and therefore survives a power cycle Null string as parameter restores the Factory setting
Preset:	This is unaffected by Preset but is set to the original factory setting on a "Restore System Defaults->Misc"
State Saved:	No
Initial S/W Revision:	A.06.00

System Functions
System

Help Map ID:	3667
--------------	------

Factory

This key selects the factory setting, for example:

“Agilent Technologies,N9020A,MY00012345,A.05.01”

where the fields are manufacturer, model number, serial number, firmware revision.

Key Path:	System, I/O Config, IDN Response
Example:	:SYST:IDN "" null string, restores the factory setting
Initial S/W Revision:	A.06.0
Help Map ID:	3665

User

This key allows you to specify your own response to the *IDN? query. You may enter your desired response with the Alpha Editor or a plugin PC keyboard.

When you press this key, the active function becomes the current User string with the cursor at the end. This makes it easy to edit the existing string.

If you enter a null string (for example, by clearing the User String while editing and then pressing **Done**) the analyzer automatically reverts to the Factory setting.

Key Path:	System, I/O Config, IDN Response
Example:	:SYST:IDN “XYZ Corp,Model 12,012345,A.01.01” user specified response
Initial S/W Revision:	A.06.00
Help Map ID:	3666

Query USB Connection (Remote Command Only)

Enables you to determine the speed of the USB connection.

Mode:	All
Remote Command:	:SYSTem:COMMunicate:USB:CONNectioN?
Example:	:SYST:COMM:USB:CONN?

Notes:	<p>NONE – Indicates no USB connection has been made.</p> <p>LSpeed – Indicates a USB low speed connection (1.5 Mbps).</p> <p>This is reserved for future use, the T+M488 protocol is not supported on low speed connections.</p> <p>HSPeed – Indicates that a USB high speed connection (480 Mbps) has been negotiated.</p> <p>FSPeed – Indicates that a USB full speed connection (12 Mbps) has been negotiated.</p>
State Saved:	No
Range:	NONE LSpeed HSPeed FSPeed
Initial S/W Revision:	Prior to A.02.00
Help Map ID:	0

USB Connection Status (Remote Command Only)

Enables you to determine the current status of the USB connection.

Mode:	All
Remote Command:	:SYSTem:COMMunicate:USB:STATus?
Example:	:SYST:COMM:USB:STAT?
Notes:	<p>SUSPended – Indicates that the USB bus is currently in its suspended state. The bus is in the suspended state when:</p> <p>The bus is not connected to any controller</p> <p>The controller is currently powered off</p> <p>The controller has explicitly placed the USB device into the suspended state.</p> <p>When in the suspended state, no USB activity, including start of frame packets are received.</p> <p>ACTive – Indicates that the USB device is in the active state. When the device is in the active state, it is receiving periodic start of frames but it isn't necessarily receiving or transmitting data.</p>
State Saved:	No
Range:	SUSPended ACTive
Initial S/W Revision:	Prior to A.02.00
Help Map ID:	0

USB Packet Count (Remote Command Only)

Enables you to determine the number of packets received and transmitted on the USB bus.

Mode:	All
Remote Command:	:SYSTem:COMMunicate:USB:PACKets?
Example:	:SYST:COMM:USB:PACK?
Notes:	Two integers are returned. The first is the number of packets received since application invocation, the second is the number of packets transmitted since application invocation. If no packets have been received or transmitted the response is 0,0. The packet count is initialized to 0,0 when the instrument application is started.
State Saved:	No
Initial S/W Revision:	Prior to A.02.00
Help Map ID:	0

Restore Defaults

Provides incremental initialization of the system setting groups along with supporting a comprehensive reset of the entire instrument back to a factory default state. The menu selections are the groups of system settings and when one is selected, that particular group of system settings is reset back to their default values.

Key Path:	System
Mode:	All
Remote Command:	:SYSTem:DEFault [ALL] ALIGn INPut MISC MODes PON
Example:	SYST:DEF
State Saved:	No
Initial S/W Revision:	Prior to A.02.00
Help Map ID:	2308

Restore Input/Output Defaults

Causes the group of settings and data associated with Input/Output front-panel key to be a reset to their default values. This level of Restore System Defaults does not affect any other system settings, mode settings and does not cause a mode switch. .

Confirmation is required to restore the Input/Output setting. The confirmation dialog is:

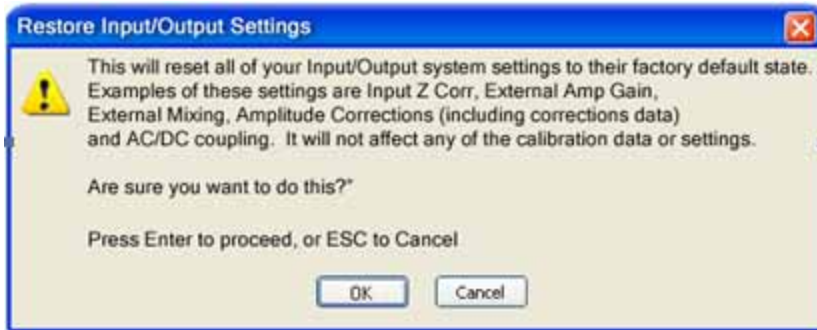

Key Path:	System, Restore System Defaults
Example:	:SYST:DEF INP
Initial S/W Revision:	Prior to A.02.00
Help Map ID:	2309

Restore Power On Defaults

This selection causes the Power On settings to be a reset to their default value. This level of Restore System Defaults does not affect any other system settings, mode settings and does not cause a mode switch. The Power On settings and their default values are Power On Type reset to Mode and Input/Output Defaults and Power On Application reset to whatever the factory set as its default value.

Confirmation is required to restore the factory default values. The confirmation dialog is:

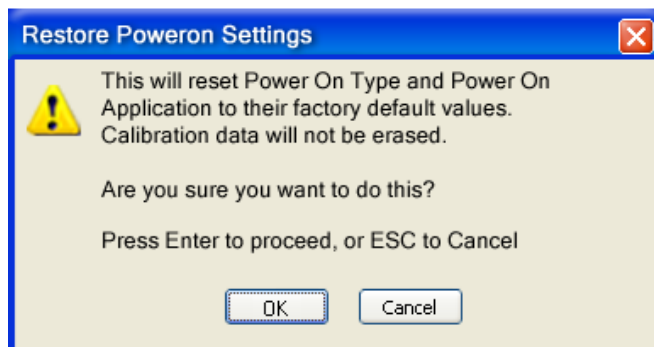

Key Path:	System, Restore System Defaults
Example:	:SYST:DEF PON
Initial S/W Revision:	Prior to A.02.00
Help Map ID:	2310

Restore Align Defaults

This selection causes the Alignment system settings to be a reset to their default values. This does not affect any Alignment data stored in the system. This level of Restore System Defaults does not affect any other system settings, mode settings and does not cause a mode switch.

System Functions

System

After performing this function, it may impact the auto-alignment time of the instrument until a new alignment baseline has been established.

Confirmation is required to restore the factory default values. The confirmation dialog is:

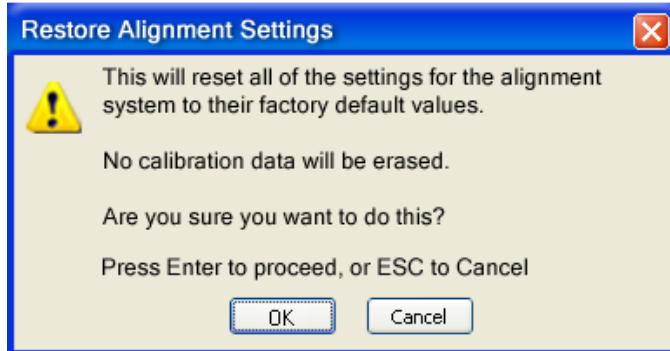

Key Path:	System, Restore System Defaults
Example:	:SYST:DEF ALIG
Initial S/W Revision:	Prior to A.02.00
Help Map ID:	2311

Restore Misc Defaults

This selection causes miscellaneous system settings to be reset to their default values. With this reset, you lose the GPIB address and it is reset to 18, so this should be used with caution. This level of Restore System Defaults does not affect any other system settings, mode settings and does not cause a mode switch. This miscellaneous group contains the rest of the settings that have not been part of the other Restore System Defaults groups. The following table is a complete list of settings associated with this group:

Miscellaneous Setting	Default Value
Verbose SCPI	Off
GPIB Address	18
Auto File Name Number	000
Save Type	State
State Save To	Register 1
Screen Save To	SCREEN000.png
DISP:ENABle	ON
Full Screen	Off
SCPI Telnet	ON
SCPI Socket	ON

Miscellaneous Setting	Default Value
SICL Server	ON
Display Intensity	100
Display Backlight	ON
Display Theme	TDColor
System Annotation	ON
The SYST:PRES:TYPE	MODE

Confirmation is required to restore the factory default values. The confirmation dialog is:

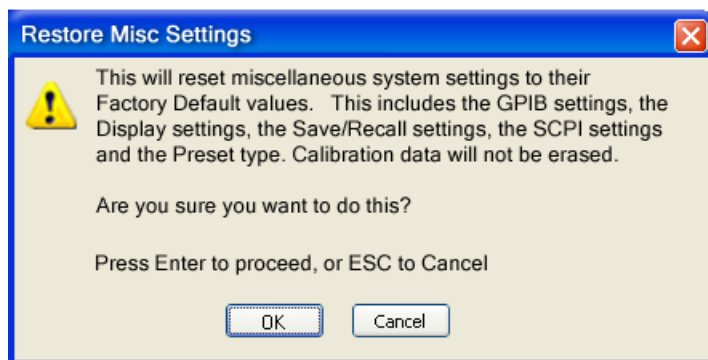

Key Path:	System, Restore System Defaults
Example:	:SYST:DEF MISC
Initial S/W Revision:	Prior to A.02.00
Help Map ID:	2312

Restore Mode Defaults (All Modes)

This selection resets all of the modes in the instrument back to their default state just as a Restore Mode Defaults does and it switches the instrument to the power-on mode and causes the default measurement for the power-on mode to be active. This level of Restore System Defaults does not affect any system settings, but it does affect the state of all modes and does cause a mode switch unless the instrument was already in the power-on mode.

Confirmation is required to restore the factory default values. The confirmation dialog is:

System Functions
System

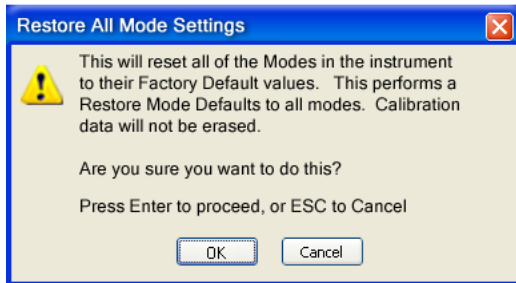

Key Path:	System, Restore System Defaults
Example:	:SYST:DEF MOD
Couplings:	An All Mode will cause the currently running measurement to be aborted, mode switch to the power-on mode and activate the default measurement for the power-on mode.. It gets the mode to a consistent state with all of the default couplings set.
Initial S/W Revision:	Prior to A.02.00
Help Map ID:	2313

All

This performs a comprehensive reset of ALL analyzer settings to their factory default values. It resets all of the system setting groups, causes a Restore Mode Defaults for all modes in the instrument, and switches back to the power-on mode. It does not affect the User Preset file or any user saved files.

Confirmation is required to restore the factory default values. The confirmation dialog is:

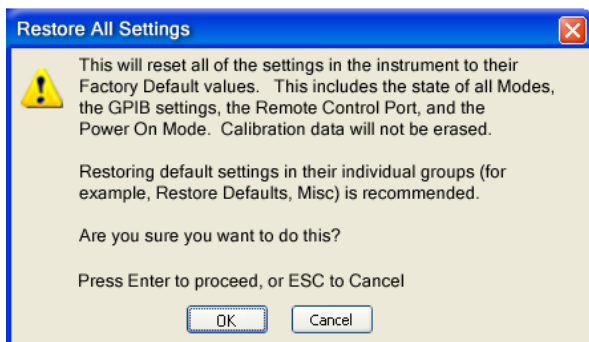

Key Path:	System, Restore System Defaults
Example:	:SYST:DEF ALL
Couplings:	An All will cause the currently running measurement to be aborted and get all modes to a consistent state, so it is unnecessary to couple any settings.
Initial S/W Revision:	Prior to A.02.00
Help Map ID:	2314

Control Panel...

Opens the Windows Control Panel. The Control Panel is used to configure certain elements of Windows that are not configured through the hardkey/softkey System menus.

The Control Panel is a separate Windows application, so to return to the analyzer once you are in the Control Panel, you may either:

Exit the Control Panel by clicking on the red X in the upper right hand corner, with a mouse

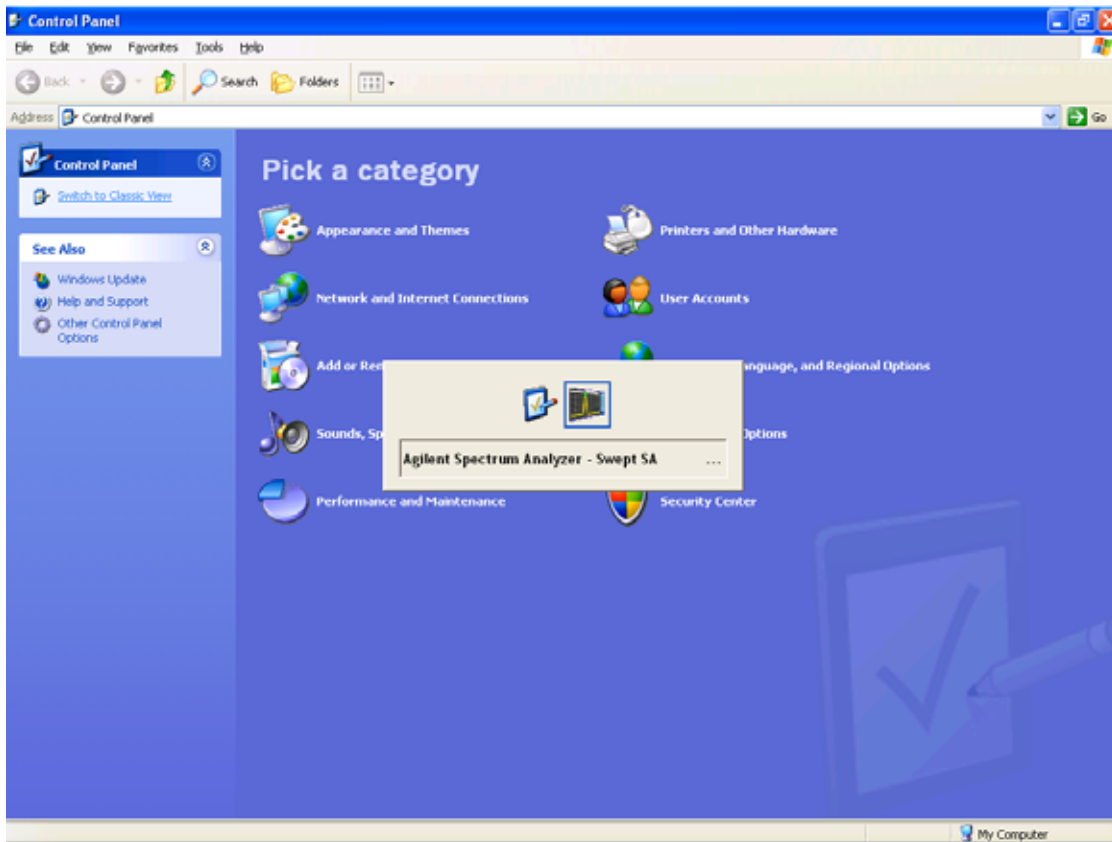

Or use Alt-Tab: press and hold the Alt  key and press and release the Tab key until the Analyzer logo is showing in the window in the center of the screen, as above, then release the Alt key.

Key Path:	System
Notes:	No remote command for this key.
Initial S/W Revision:	Prior to A.02.00
Help Map ID:	2401

Licensing...

Opens the license explorer.

System Functions
System

For Help on this key, select Help in the menu bar at the top of the license explorer window.

Key Path:	System
Notes:	No equivalent remote command for this key.
Backwards Compatibility Notes:	In ESA the SCPI command for displaying the Show Licenses screen is: :SYSTem:CONFIgure:LKEY:STATe OFF ON 0 1 :SYSTem:CONFIgure:LKEY:STATe? There are no equivalent SCPI commands in the X-Series for displaying the License Explorer.
Initial S/W Revision:	Prior to A.02.00
Help Map ID:	2402

Remote Command:	:SYSTem:LKEY <"OptionInfo">, <"LicenseInfo">
Example:	SYST:LKEY "N9073A-1FP","027253AD27F83CDA5673A9BA5F427FDA5E4F25AEB1017638211AC9F60D9C639FE539735909C551DE0A91"
Notes:	The <"OptionInfo"> contains the feature and the version. You must specify the feature but can omit the version. If you omit the version, the system regards it as the latest one, since the system knows which version is supported for each feature. The <"LicenseInfo"> contains the signature, the expiration date, and serial number for transport if transportable. You must specify the signature, but you can omit the other information. If you omit the expiration date, the system regards it as permanent. If you omit the serial number, the system regards it as non-transportable. As a result, this supports reverse compatibility.
Initial S/W Revision:	Prior to A.02.00
Help Map ID:	0

Remote Command:	:SYSTem:LKEY:DELeTe <"OptionInfo">, <"LicenseInfo">
Example:	SYST:LKEY:DEL "N9073A-1FP","027253AD27F83CDA5673A9BA5F427FDA5E4F25AEB1017638211AC9F60D9C639FE539735909C551DE0A91"
Notes:	The <"OptionInfo"> contains the feature and the version. You must specify the feature but can omit the version. If you omit the version, the system regards it as the latest one, if more than one version is installed. The <"LicenseInfo"> contains the signature, the expiration date, and whether or not be transportable. You must specify the signature, but you can omit the other information. If you omit the expiration date, the system regards it as permanent. If you omit the transportability, the system regards it as non-transportable. As a result, this supports reverse compatibility.
Initial S/W Revision:	Prior to A.02.00

Help Map ID:	0
--------------	---

Remote Command:	:SYSTem:LKEY:LIST?
Notes:	<p>Return Value:</p> <p>An <arbitrary block data> of all the installed instrument licenses.</p> <p>The format of each license is as follows.</p> <p><Feature>,<Version>,<Signature>,<Expiration Date>,<Serial Number for Transport></p> <p>Return Value Example:</p> <p>#3136</p> <p>N9073A-1FP,1.000,B043920A51CA</p> <p>N9060A-2FP,1.000,4D1D1164BE64</p> <p>N9020A-508,1.000,389BC042F920</p> <p>N9073A-1F1,1.000,5D71E9BA814C,13-aug-2005</p> <p><arbitrary block data> is:</p> <p>#NMMM<data></p> <p>Where:</p> <p>N is the number of digits that describes the number of MMM characters. For example if the data was 55 bytes, N would be 2.</p> <p>MMM would be the ASCII representation of the number of bytes. In the previous example, N would be 55.</p> <p><data> ASCII contents of the data</p>
Initial S/W Revision:	Prior to A.02.00
Help Map ID:	0

Remote Command:	:SYSTem:LKEY? <"OptionInfo" >
Example:	SYST:LKEY? "N9073A-1FP"
Notes:	<p>The <"OptionInfo"> contains the feature and the version. You must specify the feature but can omit the version. If you omit the version, the system regards it as the latest one.</p> <p>Return Value:</p> <p><"LicenseInfo"> if the license is valid, null otherwise.</p> <p><"LicenseInfo"> contains the signature, the expiration date, and serial number if transportable.</p> <p>Return Value Example:</p> <p>"B043920A51CA"</p>
Initial S/W Revision:	Prior to A.02.00

System Functions

System

Help Map ID:	0
Remote Command:	:SYSTem:HID?
Notes:	Return value is the host ID as a string
Initial S/W Revision:	Prior to A.02.00
Help Map ID:	0

Security

Accesses capabilities for operating the instrument in a security controlled environment.

Key Path:	System
Initial S/W Revision:	A.04.00
Help Map ID:	3661

USB

Read-Write

Selection for allowing full read-write access to the USB ports.

Key Path:	System, Security, USB
Example:	:SYST:SEC:USB:WPR OFF Will set USB ports to Read-Write
Initial S/W Revision:	A.04.00
Help Map ID:	3662

Read only

Selection for disabling write access to the USB ports.

Key Path:	System, Security, USB
Example:	:SYST:SEC:USB:WPR ON Will set USB ports to Read only
Initial S/W Revision:	A.04.00
Help Map ID:	3663

Diagnostics

The Diagnostics key in the System menu gives you access to basic diagnostic capabilities of the instrument.

Key Path:	System
-----------	---------------

Initial S/W Revision:	Prior to A.02.00
Help Map ID:	2445

Show Hardware Statistics

Provides a display of various hardware statistics. The statistics include the following:

Mechanical relay cycles

High and Low temperature extremes

Elapsed time that the instrument has been powered-on (odometer)

The display should appear listing the statistics, product number, serial number, and firmware revision.

Hardware Statistical Information	
Agilent MXA Signal Analyzer	
Product Number: N9020A	
Serial Number: US00061145	
Instrument S/W Revision: A.12.00	
Revision Date: 7/11/2012 12:11:10 PM	
Component Name	Value
MechAtten #1 Count Total	457304
Calibrator Switch Cycles	105953
AC/DC Switch Cycles	114240
2 dB #1 Mechanical Atten Cycles	112655
2 dB #2 Mechanical Atten Cycles	124456
MechAtten #2 Count Total	472265
6 dB Mechanical Atten Cycles	115302
10 dB Mechanical Atten Cycles	93602
20 dB Mechanical Atten Cycles	144781
30 dB Mechanical Atten Cycles	118580
Low Noise Path Switch	45668
Preselector Bypass Cycles	31133
High temperature operating extreme	45.75
Low temperature operating extreme	-23.9375
Elapsed Time (On-Time)(hours)	134164

In some CXA models this field is called "Fixed Atten"

Some CXA models omit these fields

Only shown if LNP installed

Only shown if MPB installed

The CXA models in which the AC/DC Switch field is called Fixed Atten and which omit the mech atten fields are the N9000A–503/507 models.

The data will be updated only when the Show Hardware Statistics menu key is pressed, it will not be updated while the screen is displayed.

The tabular data should be directly printable.

Key Path:	System, Diagnostics
Mode:	All

Notes:	The values displayed on the screen are only updated upon entry to the screen and not updated while the screen is being displayed.
Initial S/W Revision:	Prior to A.02.00
Help Map ID:	2446

SCPI for Show Hardware Statistics (Remote Commands Only)

Each of the hardware statistic items can be queried via SCPI.

[“Query the Mechanical Relay Cycle Count” on page 316](#)

[“Query the Operating Temperature Extremes” on page 316](#)

[“Query the Elapsed Time since 1st power on” on page 317](#)

Query the Mechanical Relay Cycle Count

Return the count of mechanical relay cycles. For N9038A model, there are additional 2 Mechanical Relays which are <N9038A Input2>, <N9038A Bypass>.

Remote Command:	:SYSTem:MRELAY:COUNT?
Example:	:SYST:MREL:COUN?
Notes:	<p>Query Only</p> <p>The return value is a comma separated list of the individual counts for each mechanical relay.</p> <p>The position of the relays in the list is:</p> <p>“<Cal Signal>,<AC/DC>,<2dB #1 Atten>,<2dB #2 Atten>,<6dB Atten>,<10dB Atten>,<20dB Atten>,<30dB Atten>,<Fixed Atten>,<Low Noise Path Switch>,<Presel Bypass>,<N9038A Input2>, <N9038A Bypass>”</p> <p>Items in the list not pertaining to your particular hardware configuration will return as -999 for those items.</p>
Dependencies:	This SCPI command is NOT supported by the E6607C model.
Initial S/W Revision:	Prior to A.02.00
Modified at S/W Revision:	A.08.00
Help Map ID:	0

Query the Operating Temperature Extremes

Returns the low operating temperature extreme value. The value survives a power-cycle and is the temperature extreme encountered since the value was reset by the factory or service center.

Mode:	All
Remote Command:	:SYSTem:TEMPerature:LEXTreme?
Example:	:SYST:TEMP:LEXT?

Notes:	Value is in degrees Celsius at which the lowest operating temperature has been recorded since 1st power-up.
State Saved:	No
Initial S/W Revision:	Prior to A.02.00
Help Map ID:	0

Mode:	All
Remote Command:	:SYSTem:TEMPerature:HEXTreme?
Example:	:SYST:TEMP:HEXT?
Notes:	Value is in degrees Celsius at which the highest operating temperature has been recorded since 1st power-up.
State Saved:	No
Initial S/W Revision:	Prior to A.02.00
Help Map ID:	0

Query the Elapsed Time since 1st power on

Returns the elapsed on-time in minutes since 1st power-on.

Remote Command:	:SYSTem:PON:ETIMe?
Example:	:SYST:PON:ETIM?
Notes:	Query Only
Initial S/W Revision:	Prior to A.02.00
Help Map ID:	0

Advanced

Accesses advanced diagnostic capabilities performed in the factory or under instructions from repair procedures. This menu key is only visible when the logged-in user is “saservice”. The first access to the Advanced Diagnostic Menu after invoking the instrument application will require an authentication, which is to enter the Service Code. Subsequent accesses to the Advanced Diagnostic Menu are unimpeded. The Authentication dialog looks like:

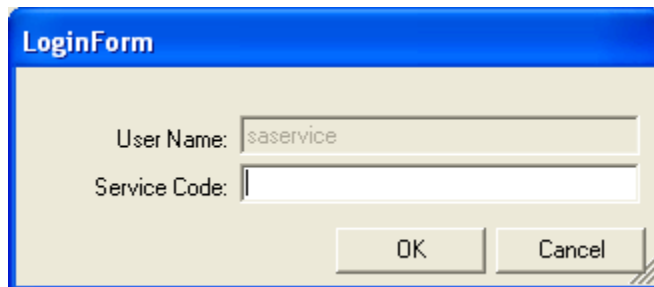

System Functions
System

“OK” is the default key thus the Enter key is used to complete the entry. If invalid Service Code is entered authentication is not granted and you are provided the following dialog:



Key Path:	System, Diagnostics
Notes:	Password is required to access this menu.
Initial S/W Revision:	Prior to A.02.00
Help Map ID:	3498

Self test

This key gives you access to diagnostic capabilities for self tests of the instrument.

Key Path:	System, Diagnostics
Initial S/W Revision:	Prior to A.10.00
Help Map ID:	50000

All Self Test

This key invokes all the self tests defined in the Diagnostics Self Test section.

Key Path:	System, Diagnostics, Self Test
Remote Command:	:SYSTem:TEST:WCTS:[ALL]
Example:	SYST:TEST:WCTS:[ALL]
Initial S/W Revision:	A.12.50
Help Map ID:	50011

Source Self Test

This key invokes the internal source self test. When operation is complete, the generated test summary file is: E:\Agilent\Instrument\CRFSSelfTestLog.txt. This test summary file can be retrieved from the instrument using the MMEM set of SCPI command, once you have the fully qualified the path and file name.

If the self test fails, the following error message will be generated:

“-330, Self-test failed, see log file E:\Agilent\Instrument\ CRFSSelfTestLog.txt”

If the self test passes, an advisory message “Source self-test completed successfully” is generated.

Key Path:	System, Diagnostics, Self Test
Remote Command:	:SYSTem:TEST:WCTS:SOURce
Example:	SYST:TEST:WCTS:SOURce
Notes:	Access log with command : MMEM:DATA? "E:\Agilent\Instrument\CRFSSelfTestLog.txt" Alias of source self test (:SOURce:SELF:TEST[:ALL])
Initial S/W Revision:	A.10.00
Help Map ID:	50001

RFIO Self Test

This key invokes the RFIO ports self test for embedded MPA, which just are available on E6607C. When operation is completed, the generated test summary information is appended to log file E:\Agilent\Instrument\RFIOTestLog.txt. This test summary file can be retrieved from the instrument using the MMEM set of SCPI command, once you have the fully qualified the path and file name.

If the self test fails, the following error message will be generated:

“-330, Self-test failed, see log file E:\Agilent\Instrument\RFIOTestLog.txt”

If the self test passes, an advisory message “RFIO self-test completed successfully” is generated.

Key Path:	System, Diagnostics, Self Test
Remote Command:	:SYSTem:TEST:WCTS:MPADapter
Example:	SYST:TEST:WCTS:MPAD
Notes:	Access log with command : MMEM:DATA? "E:\Agilent\Instrument\RFIOTestLog.txt"
Initial S/W Revision:	A.12.50
Help Map ID:	50012

NOTE This function is NOT available on EXT E6607A and E6607B models.

FEC Self Test

This key invokes the EXT E6607C froned end control self test. When operation is complete, the generated test summary information is appended to log file E:\Agilent\Instrument\FECTestLog.txt. This test summary file can be retrieved from the instrument using the MMEM set of SCPI command, once you have the fully qualified the path and file name.

If the self test fails, the following error message will be generated:

“-330, Self-test failed, see log file E:\Agilent\Instrument\FECTestLog.txt”

System Functions
System

If the self test passes, an advisory message “FEC self-test completed successfully” is generated.

Key Path:	System, Diagnostics, Self Test
Remote Command:	:SYSTem:TEST:WCTS:FEC
Example:	SYST:TEST:WCTS:FEC
Notes:	Access log with command : MMEM:DATA? "E:\ Agilent\Instrument\FECTestLog.txt"
Initial S/W Revision:	A.12.50
Help Map ID:	50013

NOTE This function is NOT available on EXT E6607A and E6607B models.

Show Result

This key gives you access to show results of the following self tests:

“[Source Self Test Results](#)” on page 320

E6607C embedded MPA self-test results - “[RFIO Self Test REsults](#)” on page 322

E6607C FEC self-test results - “[FEC Self Test REsults](#)” on page 323

Key Path:	System, Diagnostics, Self Test
Initial S/W Revision:	A.12.50
Help Map ID:	50014

Source Self Test Results

Provides a display of last source test results, the display should appear listing model number, serial number and test time at the top of display, and then list test date/time, test name, measured value, valid range and pass/fail of each source test item, the tabular data should be directly printable.

Key Path:	System, Diagnostics, Self Test,Show Results
Remote Command:	:SYSTem:TEST:WCTS:SHOW:RESult SOURce
Example:	SYST:TEST:WCTS:SHOW:RES SOUR
Initial S/W Revision:	A.12.50
Help Map ID:	50015

The example of source self test result display is as follows:

Source Self Test Results					
Produce Number: E6607B					
Serial Number: MY51380425					
Instrument S/W: 11/15/2012 2:51:19 PM					
FpgaVersionTest					
Date	Time(GMT)	Name	MeasValue	ValidRange	Result
11/23/2012	16:13:56	Analog_FPGA	16.000	>= 16.000	Pass
11/23/2012	16:13:56	Digital_FPGA	50.000	>= 46.000	Pass
11/23/2012	16:13:56	CRFS_FPGA	38.000	>= 38.000	Pass
ModulatorTest					
Date	Time(GMT)	Name	MeasValue	ValidRange	Result
11/23/2012	16:13:57	LOLevel_vs_DET_LO	-1.108	-2.200 - 2.200	Pass
11/23/2012	16:13:57	LOLevel_vs_LEVEL_DET	1.010	-1.100 - 1.100	Pass
11/23/2012	16:13:57	LOLevel_vs_LEVEL_REF	1.995	0.500 - 2.500	Pass
11/23/2012	16:13:57	QUAD_vs_DET_LO	-0.879	-1.100 - 1.100	Pass
11/23/2012	16:13:57	QUAD_vs_LEVEL_DET	0.000	-1.100 - 1.100	Pass
11/23/2012	16:13:57	QUAD_vs_LEVEL_REF	0.000	-0.300 - 0.300	Pass
11/23/2012	16:13:57	QUAD_vs_QUAD_LOOP	0.885	0.350 - 1.100	Pass
IQModulatorTest					
Date	Time(GMT)	Name	MeasValue	ValidRange	Result
11/23/2012	16:13:57	VBLO_DAC	0.154	0.000 - 0.500	Pass
11/23/2012	16:13:57	AMP_BIAS1	145.154	132.000 - 185.000	Pass
11/23/2012	16:13:57	AMP_BIAS2	145.740	132.000 - 185.000	Pass
11/23/2012	16:13:57	OFFSET_QN	0.119	0.100 - 0.125	Pass
11/23/2012	16:13:57	OFFSET_QP	0.121	0.100 - 0.125	Pass

Show Source Self Test Results contents (Remote Command Only)

A remote command is available to obtain the contents of the Show Souce Self Test Results screen (the entire contents, not just the currently displayed page).

Remote Command:	:SYSTem:TEST:WCTS:SOURce:RESult?
Example:	SYST:TEST:WCTS:SOUR:RES?

System Functions
System

Notes:	The output is an IEEE Block format of the Show Source Self Test Results contents. Each line is separated with a new-line character.
Initial S/W Revision:	A.12.50
Help Map ID:	0

RFIO Self Test Results

Provides a display of last RFIO test results for embedded MPA of E6607C, the display should appear listing model number, serial number and test time at the top of display, and then list test date/time, test name, measured value, valid range and pass/fail of each RFIO test item, the tabular data should be directly printable.

Key Path:	System, Diagnostics, Self Test, Show Results
Remote Command:	:SYSTem:TEST:WCTS:SHOW:RESult MPADapter
Example:	SYST:TEST:WCTS:SHOW:RES MPAD
Initial S/W Revision:	A.12.50
Help Map ID:	50016

NOTE This function is NOT available on EXT E6607A and E6607B models.

The example of RFIO self test result display is as following:

RFIO Self Test Results					
Produce Number: E6607C					
Serial Number: MY51380437					
Instrument S/W: 11/16/2012 2:51:19 PM					
CarrierClockTest	16:13:56				
Date	Time(GMT)	Name	MeasValue	ValidRange	Result
11/23/2012	16:13:57	Dig FPGA 100 MHz	1.000	1.000 - 1.000	Pass
11/23/2012	16:13:57	Feldspar CCLK	1.000	1.000 - 1.000	Pass
11/23/2012	16:13:57	Feldspar LVDS	1.000	1.000 - 1.000	Pass
11/23/2012	16:13:57	Dig FPGA LVDS	1.000	1.000 - 1.000	Pass
11/23/2012	16:13:57	Dig FPGA 200 MHz	1.000	1.000 - 1.000	Pass
DetectorTest					
Date	Time(GMT)	Name	MeasValue	ValidRange	Result
11/23/2012	16:13:57	ABUS_DET_SYNTH	29.879	14.400 - 100.000	Pass
11/23/2012	16:13:57	ABUS_DET_LO	18.136	9.000 - 100.000	Pass
11/23/2012	16:13:57	ABUS_DET_MOD	13.556	6.600 - 100.000	Pass

11/23/2012	16:13:57	ABUS_DET_MOD_FLT	18.000	7.800 - 100.000	Pass
FilterBankTest1					
Date	Time(GMT)	Name	MeasValue	ValidRange	Result
11/23/2012	16:13:57	Bank1_LPF_550MHz	30.357	>= 10.000	Pass
11/23/2012	16:13:57	Bank1_LPF_750MHz	29.358	>= 10.000	Pass
11/23/2012	16:13:57	Bank1_LPF_1020MHz	27.036	>= 10.000	Pass
11/23/2012	16:13:57	Bank1_LPF_1600MHz	27.594	>= 10.000	Pass
11/23/2012	16:13:57	Bank1_LPF_2400MHz	21.490	>= 10.000	Pass
11/23/2012	16:13:57	Bank1_LPF_3000MHz	18.476	>= 10.000	Pass
11/23/2012	16:13:57	OFFSET_QP	0.121	0.100 - 0.125	Pass

Show RFIO Self Test Results contents (Remote Command Only)

A remote command is available to obtain the contents of the Show RFIO Self Test Results screen (the entire contents, not just the currently displayed page).

Remote Command:	:SYSTem:TEST:WCTS:MPADapter:RESult?
Example:	SYST:TEST:WCTS:MPAD:RES?
Notes:	The output is an IEEE Block format of the Show RFIO Self Test Results contents. Each line is separated with a new-line character.
Initial S/W Revision:	A.12.50
Help Map ID:	0

FEC Self Test Results

Provides a display of last FEC test results, the display should appear listing model number, serial number and test time at the top of display, and then list test date/time, test name, measured value, valid range and pass/fail of each FEC test item, the tabular data should be directly printable.

Key Path:	System, Diagnostics, Self Test, Show Results
Remote Command:	:SYSTem:TEST:WCTS:SHOW:RESult FEC
Example:	SYST:TEST:WCTS:SHOW:RES FEC
Initial S/W Revision:	A.12.50
Help Map ID:	50017

This function is NOT available on EXT E6607A and E6607B models.

System Functions
System

The example of FEC self test result display is as follows:

FEC Self Test Results					
Produce Number: E6607C					
Serial Number: MY51380437					
Instrument S/W: 11/16/2012 2:51:19 PM					
FpgaVersionTest					
Date	Time(GMT)	Name	MeasValue	ValidRange	Result
11/23/2012	16:13:56	Analog_FPGA	16.000	>= 16.000	Pass
11/23/2012	16:13:56	Digital_FPGA	50.000	>= 46.000	Pass
11/23/2012	16:13:56	CRFS_FPGA	38.000	>= 38.000	Pass
PowerSupplyTest					
Date	Time(GMT)	Name	MeasValue	ValidRange	Result
11/23/2012	16:13:56	ABUS_+32CHK	31.904	30.900 - 32.900	Pass
11/23/2012	16:13:56	ABUS_+12CHK	12.296	10.800 - 13.200	Pass
11/23/2012	16:13:56	+10VA	9.935	9.600 - 10.200	Pass
11/23/2012	16:13:56	+5VA	4.995	4.900 - 5.100	Pass
11/23/2012	16:13:56	+3.3VA	3.299	3.200 - 3.400	Pass
11/23/2012	16:13:56	-3.3VA	-3.311	-3.400 - -3.200	Pass
11/23/2012	16:13:56	ACOM	0.00	-0.200 - 0.200	Pass
11/23/2012	16:13:56	-5VA	-5.036	-5.100 - -4.900	Pass
11/23/2012	16:13:56	-6.1VA	-5.880	-6.200 - -5.700	Pass
11/23/2012	16:13:56	-10VA	-10.116	-10.200 - -9.800	Pass
11/23/2012	16:13:56	ABUS_-2.5V_REF	-2.508	-2.520 - -2.470	Pass
11/23/2012	16:13:56	ABUS_+2.5V_REF	2.508	2.480 - 2.520	Pass
11/23/2012	16:13:56	ABUS_-10VPALC	-10.047	-10.200 - -9.800	Pass
11/23/2012	16:13:57	ABUS_DET_MOD_FLT	18.000	7.800 - 100.000	Pass

Show FEC Self Test Results contents (Remote Command Only)

A remote command is available to obtain the contents of the Show FEC Self Test Results screen (the entire contents, not just the currently displayed page).

Remote Command:	:SYSTem:TEST:WCTS:FEC:RESult?
-----------------	-------------------------------

Example:	SYST:TEST:WCTS:FEC:RES?
Notes:	The output is an IEEE Block format of the Show FEC Self Test Results contents. Each line is separated with a new-line character.
Initial S/W Revision:	A.12.50
Help Map ID:	0

Multiport Adapter Cables Test

This key gives you access to diagnostic capabilities for the RF and trigger cable connections between EXT and Multiport Adapter with this instrument, which include:

EXT RF Input <-> Multiport Adapter RF OUT

EXT RF Output <-> Multiport Adapter RF IN

EXT RF IO2 <-> Multiport Adapter GPS IN

EXT Trigger 1<-> Multiport Adapter Trigger 1

EXT Trigger 2 <-> Multiport Adapter Trigger 2

Key Path:	System, Diagnostics
Remote Command:	:CALibration:MPADapter:CABLEs:TEST
Example:	:CAL:MPAD:CABL:TEST
Notes:	If the Multiport Adapter cables are not connected correctly. It will report the proper error, for example: “-330, Self-test failed, MPA’S RF IN or RF OUT not properly connected”.
Dependencies:	This key does not appear unless a multiport adapter is plugged in to the USB. Grayout error: -221.1400; Multiport Adapter Not Available
Initial S/W Revision:	A.10.0
Help Map ID:	50018

Quick Test ...

This key gives you access to launch a Windows program for conducting a confidence check of the Agilent EXT Wireless Communications Test Set and the E6617A Multiport Adapter connected to EXT. The operator must exit Quick Test to return to the instrument application.

Key Path:	System, Diagnostics
Notes:	Operator is responsible for exiting the Quick Test and returning focus to the Instrument Application. The softkey in the menu is only displayed when the instrument is an EXT and the EXTQuickTest.exe file is present in the C:\Program Files\Agilent\EXTQuickTest folder.

System Functions
System

Initial S/W Revision:	A.09.49
Help Map ID:	50019

	Agilent Converged	PSA
IP Address	SYSTem:COMMunicate:LAN:ADDRess <string> SYSTem:COMMunicate:LAN:ADDRess?	:SYSTem:COMMunicate:LAN[:SELF]:IP <string> :SYSTem:COMMunicate:LAN[:SELF]:IP?
Gateway	SYSTem:COMMunicate:LAN:DGATeway <string> SYSTem:COMMunicate:LAN:DGATeway?	:SYSTem:COMMunicate:LAN[:SELF]:GATEway <string> :SYSTem:COMMunicate:LAN[:SELF]:GATEway?
Subnet Mask	SYSTem:COMMunicate:LAN:SMASk <string> SYSTem:COMMunicate:LAN:SMASk?	:SYSTem:COMMunicate:LAN[:SELF]:SUBNetmask <string> :SYSTem:COMMunicate:LAN[:SELF]:SUBNetmask?

Service

Accesses capabilities performed in the factory or under instructions from repair procedures. This menu key is only visible when the logged-in user is “advanceduser” or “saservice”. The first access to the Service Menu after invoking the instrument application will require an authentication Service Code.

Key Path:	System
Initial S/W Revision:	Prior to A.02.00
Help Map ID:	2500

Internet Explorer...

This key launches Microsoft Internet Explorer. A mouse and external keyboard are highly desired for using Internet Explorer. When Internet Explorer is running, close Internet Explorer to return focus to the Instrument Application (or use Alt-Tab).

Key Path:	System
Mode:	All
Notes:	No equivalent remote command for this key.
Initial S/W Revision:	A.05.01
Help Map ID:	3671

System Remote Commands (Remote Commands Only)

The commands in this section have no front-panel key equivalent.

[“System Powerdown \(Remote Command Only\)” on page 327](#)

“List installed Options (Remote Command Only)” on page 327

“Lock the Front-panel keys (Remote Command Only)” on page 327

“List SCPI Commands (Remote Command Only)” on page 328

“SCPI Version Query (Remote Command Only)” on page 328

“Date (Remote Command Only)” on page 329

“Time (Remote Command Only)” on page 329

Initial S/W Revision:	Prior to A.02.00
Help Map ID:	0

System Powerdown (Remote Command Only)

Remote Command:	:SYSTem:PDOWn [NORMal FORCe]
Notes:	Shuts down the instrument in the normal way (NORMal) or forced way (FORCe). In case there is another application with modified data pending for saving, the application prompt the user. The system waits until the user responds in the normal mode. It will go off after 20 seconds of wait in the force mode and all data will be lost.
Help Map ID:	0

List installed Options (Remote Command Only)

Lists the installed options that pertain to the instrument (signal analyzer). .

Mode:	All
Remote Command:	:SYSTem:OPTions?
Example:	:SYST:OPT?
Notes:	The return string is a comma separated list of the installed options. For example: “503,P03,PFR” :SYSTem:OPTions? and *OPT? are the same.
State Saved:	No
Initial S/W Revision:	Prior to A.02.00
Help Map ID:	0

Lock the Front-panel keys (Remote Command Only)

Disables the instrument keyboard to prevent local input when the instrument is controlled remotely. Annunciation showing a “K” for ‘Klock’ (keyboard lock) alerts the local user that the keyboard is locked. Klock is similar to the GPIB Local Lockout function; namely that no front-panel keys are active with the exception of the Power Standby key. (The instrument is allowed to be turned-off if Klock is

System Functions
System

ON.) The Klock command is used in remote control situations where Local Lockout cannot be used.

Although primary intent of Klock is to lock-out the front panel, it will lock-out externally connected keyboards through USB. Klock has no effect on externally connected pointing devices (mice).

The front panel 'Local' key (Cancel/Esc) has no effect if Klock is ON.

Mode:	All
Remote Command:	:SYSTem:KLOCK OFF ON 0 1 :SYSTem:KLOCK?
Example:	:SYST:KLOC ON
Notes:	Keyboard lock remains in effect until turned-off or the instrument is power-cycled
Preset:	Initialized to OFF at startup, unaffected by Preset
State Saved:	No
Initial S/W Revision:	Prior to A.02.00
Help Map ID:	0

List SCPI Commands (Remote Command Only)

Outputs a list of the valid SCPI commands for the currently selected Mode.

Remote Command:	:SYSTem:HELP:HEADers?
Example:	:SYST:HELP:HEAD?
Notes:	The output is an IEEE Block format with each command separated with the New-Line character (hex 0x0A)
Initial S/W Revision:	Prior to A.02.00
Help Map ID:	0

SCPI Version Query (Remote Command Only)

Returns the SCPI version number with which the instrument complies. The SCPI industry standard changes regularly. This command indicates the version used when the instrument SCPI commands were defined.

Remote Command:	:SYSTem:VERSion?
Example:	:SYST:VERS?
Initial S/W Revision:	Prior to A.02.00
Help Map ID:	0

Date (Remote Command Only)

The recommended access to the Date, Time, and Time zone of the instrument is through the Windows native control (Control Panel or accessing the Task Bar). You may also access this information remotely, as shown in this command and Time (below).

Sets or queries the date in the instrument.

Mode:	All
Remote Command:	:SYSTem:DATE "<year>, <month>, <day>" :SYSTem:DATE?
Example:	:SYST:DATE "2006,05,26"
Notes:	<year> is the four digit representation of year. (for example, 2006) <month> is the two digit representation of year. (for example. 01 to 12) <day> is the two digit representation of day. (for example, 01 to 28, 29, 30, or 31) depending on the month and year Unless the current account has Power User or Administrator privileges, an error will be generated by this command and no action will be taken.
Initial S/W Revision:	Prior to A.02.00
Help Map ID:	0

Time (Remote Command Only)

Sets or queries the time in the instrument.

Mode:	All
Remote Command:	:SYSTem:TIME "<hour>, <minute>, <second>" :SYSTem:TIME?
Example:	:SYST:TIME "13,05,26"
Notes:	<hour> is the two digit representation of the hour in 24 hour format <minute> is the two digit representation of minute <second> is the two digit representation of second Unless the current account has Power User or Administrator privileges, an error will be generated by this command and no action will be taken.
Initial S/W Revision:	Prior to A.02.00
Help Map ID:	0

User Preset

Accesses a menu that gives you the following three choices:

User Preset – recalls a state previously saved using the Save User Preset function.

User Preset All Modes – presets all of the modes in the analyzer

Save User Preset – saves the current state for the current mode

Key Path:	Front-panel key
Backwards Compatibility Notes:	<p>User Preset is actually loading a state, and in legacy analyzers, it was possible to load a state without affecting the trace data, limit lines or correction data. Similarly it was possible to do a User Preset without affecting the trace data, limit lines or correction data.</p> <p>In the X-Series, “state” always includes all of this data; so whenever state is loaded, or User Preset is executed, all of the traces, limit lines and corrections are affected. Although this differs from previous behavior, it is desirable behavior, and should not cause adverse issues for users.</p> <p>On ESA and PSA, User Preset affected the entire instrument’s state. In the X-Series, User Preset only recalls the state for the active mode. There is a User Preset file for each mode. User Preset can never cause a mode switch as it can in legacy analyzers. If you want to recall all modes to their user preset file state, you will need to do a User Preset after mode switching into each mode.</p> <p>User Preset recalls mode state which can now include data like traces; whereas on ESA and PSA, User Preset did not affect data.</p>
Initial S/W Revision:	Prior to A.02.00
Help Map ID:	2024

User Preset

User Preset sets the state of the currently active mode back to the state that was previously saved for this mode using the Save User Preset menu key or the SCPI command, `SYST:PRES:USER:SAV`. It not only recalls the Mode Preset settings, but it also recalls all of the mode persistent settings, and the Input/Output system setting that existed at the time Save User Preset was executed.

If a Save User Preset has not been done at any time, User Preset recalls the default user preset file for the currently active mode. The default user preset files are created if, at power-on, a mode detects there is no user preset file. There will never be a scenario when there is no user preset file to restore. For each mode, the default user preset state is the same state that would be saved if a Save User Preset is performed in each mode right after doing a Restore Mode Default and after a Restore Input/Output Defaults.

The User Preset function does the following:

Aborts the currently running measurement.

Sets the mode State to the values defined by Save User Preset.

Makes the saved measurement for the currently running mode the active measurement.

Brings up the saved menu for the power-on mode.

Clears the input and output buffers.

Sets the Status Byte to 0.

Key Path:	User Preset
Remote Command:	:SYSTem:PRESet:USER
Example:	:SYST:PRES:USER:SAVE :SYST:PRES:USER
Notes:	:SYST:PRES:USER:SAVE is used to save the current state as the user preset state. Clears all pending OPC bits. The Status Byte is set to 0. Pressing the User Preset front-panel key while already in the User Preset menu will cause the User Preset to get executed
Couplings:	A user preset will cause the currently running measurement to be aborted and cause the saved measurement to be active. Recalling a User Preset file has the same issues that recalling a Save State file has. Some settings may need to be limited and therefore re-coupled, since the capabilities of the mode may have changes when the User Preset file was last saved.
Initial S/W Revision:	Prior to A.02.00
Help Map ID:	2302

User Preset All Modes

Recalls all of the User Preset files for each mode, switches to the power-on mode, and activates the saved measurement from the power-on mode User Preset file.

NOTE When the instrument is secured, all of the user preset files are converted back to their default user preset files.

The User Preset function does the following:

Aborts the currently running measurement.

Switches the Mode to the power-on mode.

Restores the User Preset files for each mode.

Makes the saved measurement for the power-on mode the active measurement.

Brings up the saved menu for the power-on mode.

Clears the input and output buffers.

System Functions
User Preset

Sets the Status Byte to 0.

Key Path:	User Preset
Remote Command:	:SYSTem:PRESet:USER:ALL
Example:	:SYST:PRES:USER:SAVE :SYST:PRES:USER:ALL
Notes:	Clears all pending OPC bits. The Status Byte is set to 0. :SYST:PRES:USER:SAVE is used to save the current state as the user preset state.
Couplings:	A user preset will cause the currently running measurement to be aborted, cause a mode switch to the power-on mode, and cause the saved measurement to be active in the power-on mode. Recalling a User Preset file has the same issues that recalling a Save State file has. Some settings may need to be limited and therefore re-coupled, since the capabilities of the mode may have changes when the User Preset file was last saved.
Initial S/W Revision:	Prior to A.02.00
Help Map ID:	2303

Save User Preset

Saves the currently active mode and its State. You can recall this User Preset file by pressing the User Preset menu key or sending the SYST:PRES:USER remote command. This same state is also saved by the Save State function.

Key Path:	User Preset
Remote Command:	:SYSTem:PRESet:USER:SAVE
Example:	:SYST:PRES:USER:SAVE
Notes:	:SYST:PRES:SAVE creates the same file as if the user requested a *SAV or a MMEM:STOR:STAT, except User Preset Save does not allow the user to specify the filename or the location of the file.
Initial S/W Revision:	Prior to A.02.00
Help Map ID:	2304

The Channel Power measurement is used to find the total power present in a specified bandwidth. The power spectral density (the power in the signal normalized to 1 Hz) is also reported (In WLAN mode, the peak power spectral density for 1 MHz is reported). For measurement results and views, see [“View/Display” on page 394](#).

This topic contains the following sections:

[“Measurement Commands for Channel Power” on page 333](#)

[“Remote CommandResults for Channel Power Measurement” on page 334](#)

Measurement Commands for Channel Power

These commands are used to measure the total rms power in a specified integration bandwidth.

Use :INSTrument:SELEct to set the mode.

:CONFIgure:CHPower

:CONFIgure:CHPower:NDEFault

:INITiate:CHPower

:FETCh:CHPower [n] ?

:MEASure:CHPower [n] ?

:READ:CHPower [n] ?

:FETCh:CHPower:CHPower?

:MEASure:CHPower:CHPower?

:READ:CHPower:CHPower?

:FETCh:CHPower:DENSity?

:MEASure:CHPower:DENSity?

:READ:CHPower:DENSity

For more measurement related commands, see the SENSE subsystem, and the section [Remote Measurement Functions@29978](#).

Remote CommandResults for Channel Power Measurement

Command	Return Value
FETCh:CHPower[n]? MEASure:CHPower[n]? READ:CHPower[n]?	Refer to the table below.
FETCh:CHPower:CHPower? MEASure:CHPower:CHPower? READ:CHPower:CHPower?	Returns the Channel Power (dBm) (BW compatibility functionality)
FETCh:CHPower:DENSity? MEASure:CHPower:DENSity? READ:CHPower:DENSity?	Returns the Power Spectral Density (dBm/Hz) (BW compatibility functionality)

n	Results Returned
n=1 (or not specified)	Returns scalar results: <ol style="list-style-type: none"> 1. Channel Power is a floating point number representing the total channel power in the specified integration bandwidth. 2. PSD (Power Spectral Density) is the power in the specified unit bandwidth. The unit bandwidth is selected by the PSD Unit parameter in either dBm/Hz or dBm/MHz.
2	Returns floating point numbers that are the captured trace data of the power (in dBm/resolution BW) of the signal. The frequency span of the captured trace data is specified by the Span key.

Remote Command Results for WLAN Channel Power Measurement

n	Results Returned
n=1 (or not specified)	<p>Returns scalar results:</p> <p>When the radio standard is NOT WLAN 802.11ac 80 + 80 MHz:</p> <ol style="list-style-type: none"> 1. Channel Power is a floating point number representing the total channel power in the specified integration bandwidth. 2. PSD (Power Spectral Density) is the power in the specified unit bandwidth. The unit bandwidth is selected by the PSD Unit parameter in either dBm/Hz or dBm/MHz. <p>When the radio standard is WLAN 802.11ac 80 + 80 MHz:</p> <ol style="list-style-type: none"> 1. Channel Power of the carrier of which the center frequency is indicated by Freq Segment 1 is a floating point number representing the total channel power of the first segment in the specified integration bandwidth. 2. PSD (Power Spectral Density) of the carrier of which the center frequency is indicated by Freq Segment 1 is the power in the specified unit bandwidth of the first segment. The unit bandwidth is selected by the PSD Unit parameter in either dBm/Hz or dBm/MHz. 3. Channel Power of the carrier of which the center frequency is indicated by Freq Segment 2 is a floating point number representing the total channel power of the second segment in the specified integration bandwidth. 4. PSD (Power Spectral Density) of the carrier of which the center frequency is indicated by Freq Segment 2 is the power in the specified unit bandwidth of the second segment. The unit bandwidth is selected by the PSD Unit parameter in either dBm/Hz or dBm/MHz.
2	Returns floating point numbers that are the captured trace data of the power (in dBm/resolution BW) of the signal. The frequency span of the captured trace data is specified by the Span key.

Key Path:	Meas
Mode:	WCDMA, C2K, WIMAX OFDMA, 1xEVDO, LTE, LTETDD, WLAN
Initial S/W Revision:	Prior to A.02.00
Modified at S/W Revision:	A.03.00
Help Map ID:	6043

AMPTD Y Scale

Accesses a menu of functions that enable you to set the vertical scale parameters. The parameter values are measurement independent, except all Attenuation values and the Internal Preamp selection, which are the same across all measurements.

Key Path:	Front-panel key
Initial S/W Revision:	Prior to A.02.00
Help Map ID:	6045

Ref Value

Sets the value for the absolute power reference. However, since the Auto Scaling is defaulted to On, this value is automatically determined by the measurement result. When you set a value manually, Auto Scaling automatically changes to Off.

Key Path:	AMPTD Y Scale
Mode:	WCDMA, C2K, WIMAX OFDMA, 1xEVDO, LTE, LTETDD, WLAN
Remote Command:	:DISPlay:CHPower:VIEW[1]:WINDow[1]:TRACe:Y[:SCALE]:RLEV el <real> :DISPlay:CHPower:VIEW[1]:WINDow[1]:TRACe:Y[:SCALE]:RLEV el?
Example:	DISP:CHP:VIEW:WIND:TRAC:Y:RLEV 10 dBm DISP:CHP:VIEW:WIND:TRAC:Y:RLEV?
Notes:	You must be in the W-CDMA mode, cdma2000 mode, LTD mode, LTE TDD mode, WLAN mode, 1xEVDO mode, or WIMAX OFDMA mode to use this command. Use :INSTrument:SElect to set the mode.
Couplings:	When the Auto Scaling is On, this value is automatically determined by the measurement result. When you set a value manually, Auto Scaling automatically changes to Off.
Preset:	10.00 dBm
State Saved:	Saved in instrument state.
Min:	-250.00 dBm
Max:	250.00 dBm
Initial S/W Revision:	Prior to A.02.00
Modified at S/W Revision:	A.02.00, A.03.00
Help Map ID:	6002

Attenuation

Accesses a menu of functions that enable you to change the attenuation settings. This key has read-back text that describes the total attenuator value.

See AMPTD Y Scale, [Attenuation@3003](#) for more information.

Key Path:	AMPTD/Y Scale
Initial S/W Revision:	Prior to A.02.00
Help Map ID:	6053

Scale/Div

Sets the units per division of the vertical scale in the logarithmic display. However, since the Auto Scaling is defaulted to On, this value is automatically determined by the measurement result. When you set a value manually, Auto Scaling automatically changes to Off.

Key Path:	AMPTD Y Scale
Mode:	WCDMA, C2K, WIMAX OFDMA, 1xEVDO, LTE, LTETDD, WLAN
Remote Command:	:DISPlay:CHPower:VIEW[1]:WINDow[1]:TRACe:Y[:SCALe]:PDIV ision <rel_ampl> :DISPlay:CHPower:VIEW[1]:WINDow[1]:TRACe:Y[:SCALe]:PDIV ision?
Example:	DISP:CHP:VIEW:WIND:TRAC:Y:PDIV 2 DISP:CHP:VIEW:WIND:TRAC:Y:PDIV?
Notes:	You must be in the W-CDMA mode, cdma2000 mode, LTD mode, LTE TDD mode, WLAN mode, 1xEVDO mode, or WIMAX OFDMA mode to use this command. Use :INSTrument:SELEct to set the mode.
Couplings:	When the Auto Scaling is On, this value is automatically determined by the measurement result. When you set a value manually, Auto Scaling automatically changes to Off.
Preset:	10.00 dB
State Saved:	Saved in instrument state.
Min:	0.10 dB
Max:	20.00 dB
Initial S/W Revision:	Prior to A.02.00
Modified at S/W Revision:	A.02.00, A.03.00
Help Map ID:	6003

Y Axis Unit

Allows you to change the vertical (Y) axis amplitude unit.

See [Y Axis Unit@3021@i](#) under AMPTD Y Scale for more information.

Key Path:	AMPTD/Y Scale
Initial S/W Revision:	A.04.00
Help Map ID:	0

Internal Preamp

Accesses a menu of functions that enable you to control the internal preamplifiers.

See AMPTD Y Scale, [Internal Preamp@3036](#) for more information.

Key Path:	AMPTD/Y Scale
Initial S/W Revision:	Prior to A.02.00
Help Map ID:	6054

Ref Position

Positions the reference level at the top, center, or bottom of the Y Scale display. Changing the reference position does not change the reference level value.

Key Path:	AMPTD Y Scale
Mode:	WCDMA, C2K, WIMAX OFDMA, 1xEVDO, LTE, LTETDD, WLAN
Remote Command:	:DISPlay:CHPower:VIEW[1]:WINDow[1]:TRACe:Y[:SCALE]:RPOS ition TOP CENTer BOTTom :DISPlay:CHPower:VIEW[1]:WINDow[1]:TRACe:Y[:SCALE]:RPOS ition?
Example:	DISP:CHP:VIEW:WIND:TRAC:Y:RPOS CENT DISP:CHP:VIEW:WIND:TRAC:Y:RPOS?
Notes:	You must be in the W-CDMA mode, cdma2000 mode, LTD mode, LTE TDD mode, WLAN mode, 1xEVDO mode, or WIMAX OFDMA mode to use this command. Use :INSTrument:SELect to set the mode.
Preset:	TOP
State Saved:	Saved in instrument state.
Range:	Top Ctr Bot
Initial S/W Revision:	Prior to A.02.00
Modified at S/W Revision:	A.02.00, A.03.00

Help Map ID:	6004
--------------	------

Auto Scaling

Toggles the Auto Scaling function between On and Off.

Key Path:	AMPTD Y Scale
Mode:	WCDMA, C2K, WIMAX OFDMA, 1xEVDO, LTE, LTETDD, WLAN
Remote Command:	:DISPlay:CHPower:VIEW[1]:WINDow[1]:TRACe:Y[:SCALe]:COUPlE 0 1 OFF ON :DISPlay:CHPower:VIEW[1]:WINDow[1]:TRACe:Y[:SCALe]:COUPlE?
Example:	DISP:CHP:VIEW:WIND:TRAC:Y:COUP OFF DISP:CHP:VIEW:WIND:TRAC:Y:COUP?
Couplings:	When Auto Scaling is On, and the Restart front-panel key is pressed, this function automatically sets the scale per division to 10 dB and determines the reference values based on the measurement results. When you set a value to either Scale/Div or Ref Value manually, Auto Scaling automatically changes to Off.
Preset:	1
State Saved:	Saved in instrument state.
Range:	On Off
Initial S/W Revision:	Prior to A.02.00
Modified at S/W Revision:	A.02.00, A.03.00
Help Map ID:	6005

Auto Couple

See AUTO_COUPLE@3041@i for more information.

Key Path:	Front-panel key
Help Map ID:	0

BW

Accesses a menu of functions that enable you to specify and control the video and resolution bandwidths. You can also select the type of filter for the measurement and set the filter bandwidth.

Key Path:	Front-panel key
Initial S/W Revision:	Prior to A.02.00
Help Map ID:	6049

Res BW

Sets the value of the resolution bandwidth (RBW). If an unavailable bandwidth is entered with the numeric keypad, the closest available bandwidth is selected.

Key Path:	BW
Mode:	WCDMA, C2K, WIMAX OFDMA, 1xEVDO, LTE, LTETDD, WLAN
Remote Command:	[:SENSe]:CHPower:BANDwidth[:RESolution] <bandwidth> [:SENSe]:CHPower:BANDwidth[:RESolution]? [:SENSe]:CHPower:BANDwidth[:RESolution]:AUTO ON OFF 1 0 [:SENSe]:CHPower:BANDwidth[:RESolution]:AUTO?
Example:	CHP:BAND 5 MHz CHP:BAND? CHP:BAND:AUTO ON CHP:BAND:AUTO?
Notes:	You must be in the W-CDMA mode, cdma2000 mode, LTD mode, LTE TDD mode, WLAN mode, 1xEVDO mode, or WIMAX OFDMA mode to use this command. Use :INSTrument:SElect to set the mode.
Couplings:	Sweep time is coupled to the RBW. As the RBW changes, the sweep time (if set to Auto) is changed to maintain amplitude calibration. Video bandwidth (VBW) is coupled to the RBW. As the resolution bandwidth changes, the video bandwidth (if set to Auto) changes to maintain the ratio of VBW/RBW (10:1). When the Res BW is set to Auto, the resolution bandwidth is auto-coupled to the span. The ratio of Span/RBW is approximately 106:1 when auto coupled. When Res BW is set to Man, and the bandwidths are entered manually, these bandwidths are used regardless of other analyzer settings.

Channel Power Measurement
BW

Preset:	WCDMA: 240 kHz C2K: 24 kHz WIMAX OFDMA: 100kHz 1xEVDO: 30kHz LTE: Auto LTETDD: Auto WLAN: 100 kHz WCDMA, C2K, 1xEVDO , WIMAX OFDMA, WLAN: OFF LTE, LTETDD: ON
State Saved:	Saved in instrument state.
Min:	1 Hz
Max:	8 MHz
Backwards Compatibility SCPI:	[:SENSe]:CHPower:BWIDth[:RESolution]
Initial S/W Revision:	Prior to A.02.00
Modified at S/W Revision:	A.02.00, A.03.00
Help Map ID:	6009

Video BW

Changes the analyzer post-detection filter (VBW).

Key Path:	BW
Mode:	WCDMA, C2K, WIMAX OFDMA, 1xEVDO, LTE, LTETDD, WLAN
Remote Command:	[:SENSe]:CHPower:BANDwidth:VIDeo <bandwidth> [:SENSe]:CHPower:BANDwidth:VIDeo? [:SENSe]:CHPower:BANDwidth:VIDeo:AUTO ON OFF 1 0 [:SENSe]:CHPower:BANDwidth:VIDeo:AUTO?
Example:	CHP:BAND:VID 2.4 MHz CHP:BAND:VID? CHP:BAND:VID:AUTO OFF CHP:BAND:VID:AUTO?
Notes:	You must be in the W-CDMA mode, cdma2000 mode, LTD mode, LTE TDD mode, WLAN mode, 1xEVDO mode, or WIMAX OFDMA mode to use this command. Use :INSTrument:SElect to set the mode.
Dependencies:	See Couplings

Couplings:	<p>Video bandwidth (VBW) is coupled to the RBW. As the resolution bandwidth changes, the video bandwidth (if set to Auto) changes to maintain the ratio set by VBW/RBW.</p> <p>Sweep Time is coupled to the Video Bandwidth (VBW). As the VBW is changed, the sweep time (when set to Auto) is changed to maintain amplitude calibration. This occurs because of common hardware between the two circuits, even though the Video BW filter is not actually “in-circuit” when the detector is set to Average. Because the purpose of the average detector and the VBW filter are the same, either can be used to reduce the variance of the result.</p> <p>Although the VBW filter is not “in-circuit” when using the average detector, the Video BW key can have an effect on (Auto) sweep time, and is not disabled. In this case, reducing the VBW setting increases the sweep time, which increases the averaging time, producing a lower-variance trace.</p> <p>When using the average detector with either Sweep Time set to Man, or in zero span, the VBW setting has no effect and is disabled (grayed out).</p> <p>When the video bandwidth is AUTO coupled, the video bandwidth value is set to: Resolution Bandwidth * Video Bandwidth to Resolution Bandwidth Ratio</p>
Preset:	<p>WCDMA: 2.4MHz</p> <p>C2K: 240 kHz</p> <p>WIMAX OFDMA: Auto</p> <p>1xEVDO: 300 kHz</p> <p>LTE: Auto</p> <p>LTETDD: Auto</p> <p>WLAN: Auto</p> <p>ON</p>
State Saved:	Saved in instrument state.
Min:	1 Hz
Max:	50 MHz
Initial S/W Revision:	Prior to A.02.00
Modified at S/W Revision:	A.02.00, A.03.00
Help Map ID:	6010

Filter Type

Selects the type of bandwidth filter that is used. The choices are Gaussian or Flat top.

Key Path:	BW
Mode:	WCDMA, C2K, WIMAX OFDMA, 1xEVDO, LTE, LTETDD, WLAN

Channel Power Measurement
BW

Remote Command:	<code>[:SENSe] :CHPower: BANDwidth: SHAPe GAUSSian FLATtop</code> <code>[:SENSe] :CHPower: BANDwidth: SHAPe?</code>
Example:	<code>CHP: BAND: SHAP GAUS</code> <code>CHP: BAND: SHAP?</code>
Preset:	GAUSSian
State Saved:	Saved in instrument state.
Range:	Gaussian Flattop
Backwards Compatibility SCPI:	<code>[:SENSe] :CHPower: BWIDth: SHAPe</code>
Initial S/W Revision:	Prior to A.02.00
Modified at S/W Revision:	A.02.00, A.03.00
Help Map ID:	6011

Cont

See [Cont \(Continuous Measurement/Sweep\)@3309@i](#) in the "Common Measurement Functions" section for more information.

Key Path:	Front-panel key
Help Map ID:	0

FREQ Channel

See [FREQ Channel@\(SA, LTE, LTE TDD, OFDMA, WLAN, 1xEVDO\)3057, \(WCDMA\)4564, \(cdma2000\)26103, \(DVB-T/H\)31073, \(DTMB\)30868, \(CMMB\)40063, \(ISDB-T\)40276, \(Digital Cable TV\)41906, \(MSR\)45070](#) in the "Common Measurement Functions" fsection or more information.

Key Path:	Front-panel key
Help Map ID:	0

Input/Output

See [Key and Command Descriptions@3065@i](#) for more information.

Key Path:	Front-panel key
Help Map ID:	0

Marker

Accesses a menu that enables you to select, set up and control the markers for the current measurement.

Key Path:	Front-panel key
Initial S/W Revision:	Prior to A.02.00
Help Map ID:	6080

Select Marker

Displays 12 markers available for selection.

Key Path:	Marker
Initial S/W Revision:	Prior to A.02.00
Help Map ID:	6061

Marker Type

Sets the marker control mode to **Normal**, **Delta**, **Fixed** or **Off**. All interactions and dependencies detailed under the key description are enforced when the remote command is sent. If the selected marker is Off, pressing Marker sets it to Normal and places it at the center of the screen on the trace determined by the **Marker Trace** rules. At the same time, **Marker X Axis Value** appears on the Active Function area.

The default active function is the active function for the currently selected marker control mode. If the current control mode is Off, there is no active function and the active function is turned off.

Key Path:	Marker
Mode:	WCDMA, C2K, WIMAX OFDMA, 1xEVDO, LTE, LTETDD, WLAN
Remote Command:	:CALCulate:CHPower:MARKer [1] 2 3 4 5 6 7 8 9 10 11 12 :M ODE POSition DELTA OFF :CALCulate:CHPower:MARKer [1] 2 3 4 5 6 7 8 9 10 11 12 :M ODE?
Example:	CALC:CHP:MARK3:MODE POS CALC:CHP:MARK3:MODE?

Notes:	<p>If the selected marker is Off, pressing Marker sets it to Normal and places it at the center of the screen on the trace determined by the Marker Trace rules. At the same time, Marker X Axis Value appears on the Active Function area.</p> <p>Default Active Function: the active function for the selected marker's current control mode. If the current control mode is Off, there is no active function and the active function is turned off.</p> <p>Active Function Display: the marker X axis value entered in the active function area displays the marker value to its full entered precision.</p>
Preset:	OFF
State Saved:	Saved in instrument state.
Range:	Normal Delta Off
Initial S/W Revision:	Prior to A.02.00
Modified at S/W Revision:	A.02.00, A.03.00
Help Map ID:	6034

Marker X Axis Value (Remote Command Only)

Sets the marker X Axis value in the current marker X Axis Scale unit. It has no effect if the control mode is **Off**, but is the SCPI equivalent of entering an X value if the control mode is **Normal**, **Delta**, or **Fixed**.

Mode:	WCDMA, C2K, WIMAX OFDMA, 1xEVDO, LTE, LTETDD, WLAN
Remote Command:	<pre>:CALCulate:CHPower:MARKer [1] 2 3 4 5 6 7 8 9 10 11 12 : X <real></pre> <pre>:CALCulate:CHPower:MARKer [1] 2 3 4 5 6 7 8 9 10 11 12 : X ?</pre>
Example:	<pre>CALC:CHP:MARK3:X 0</pre> <pre>CALC:CHP:MARK3:X?</pre>
Notes:	The query returns the marker's absolute X Axis value if the control mode is Normal , or the offset from the marker's reference marker if the control mode is Delta . The query is returned in the fundamental units for the current marker X Axis scale: Hz for Frequency .
Preset:	After a preset, all markers are turned OFF, so Marker X Axis Value query returns a not a number (NAN).
State Saved:	Saved in instrument state.
Min:	-9.9E+37
Max:	9.9E+37
Initial S/W Revision:	Prior to A.02.00
Modified at S/W Revision:	A.02.00, A.03.00
Help Map ID:	0

Marker X Axis Position (Remote Command Only)

Sets the marker X Axis Scale position in trace points. This setting has no effect if the control mode is **Off**, but is the SCPI equivalent of entering a value if the control mode is **Normal** or **Delta**. The entered value is immediately translated into the current X Axis Scale units for setting the value of the marker.

Mode:	WCDMA, C2K, WIMAX OFDMA, 1xEVDO, LTE, LTETDD, WLAN
Remote Command:	:CALCulate:CHPower:MARKer [1] 2 3 4 5 6 7 8 9 10 11 12 :X :POSition <real> :CALCulate:CHPower:MARKer [1] 2 3 4 5 6 7 8 9 10 11 12 :X :POSition?
Example:	CALC:CHP:MARK10:X:POS 0 CALC:CHP:MARK10:X:POS?
Notes:	The query returns the marker's absolute X Axis value in trace points if the control mode is Normal , or the offset from the marker's reference marker in trace points if the control mode is Delta .
Preset:	After a preset, all markers are turned OFF, so Marker X Axis Value query returns a not a number (NAN).
State Saved:	Saved in instrument state.
Min:	-9.9E+37
Max:	9.9E+37
Initial S/W Revision:	Prior to A.02.00
Modified at S/W Revision:	A.02.00, A.03.00
Help Map ID:	0

Marker Y Axis Value (Remote Command only)

Returns the marker Y Axis value in the current marker Y Axis unit.

Mode:	WCDMA, C2K, WIMAX OFDMA, 1xEVDO, LTE, LTETDD, WLAN
Remote Command:	:CALCulate:CHPower:MARKer [1] 2 3 4 5 6 7 8 9 10 11 12 :Y ?
Example:	CALC:CHP:MARK11:Y?
Preset:	Result dependent on Markers setup and signal source.
State Saved:	Saved in instrument state.
Initial S/W Revision:	Prior to A.02.00
Modified at S/W Revision:	A.02.00, A.03.00
Help Map ID:	0

Properties

Accesses the marker properties menu.

Key Path:	Marker
Initial S/W Revision:	Prior to A.02.00
Help Map ID:	6059

Select Marker

Displays 12 markers available for selection.

Key Path:	Marker
Initial S/W Revision:	Prior to A.02.00
Help Map ID:	6062

Relative To

Sets the reference marker to which the selected marker is relative.

Key Path:	Marker, Properties
Mode:	WCDMA, C2K, WIMAX OFDMA, 1xEVDO, LTE, LTETDD, WLAN
Remote Command:	:CALCulate:CHPower:MARKer [1] 2 3 4 5 6 7 8 9 10 11 12 :R EFerence <integer> :CALCulate:CHPower:MARKer [1] 2 3 4 5 6 7 8 9 10 11 12 :R EFerence?
Example:	CALC:CHP:MARK:REF 5 CALC:CHP:MARK:REF?
Notes:	A marker cannot be relative to itself so that choice is grayed out, and if sent from SCPI generates error -221: "Settings conflict; marker cannot be relative to itself." When queried, a single value is returned (the specified marker numbers relative marker).
Preset:	2 3 4 5 6 7 8 9 10 11 12 1
State Saved:	Saved in instrument state.
Min:	1
Max:	12
Initial S/W Revision:	Prior to A.02.00
Modified at S/W Revision:	A.02.00, A.03.00
Help Map ID:	6038

Couple Markers

When this function is active, moving any marker causes an “equal X Axis movement” of every other marker that is not set to **Off**. By “equal X Axis movement” we mean that we preserve the difference between each marker’s X Axis value (in the fundamental x-axis units of the trace that marker is on) and the X Axis value of the marker being moved (in the same fundamental x-axis units).

This may result in markers going off screen.

Key Path:	Marker
Mode:	WCDMA, C2K, WIMAX OFDMA, 1xEVDO, LTE, LTETDD, WLAN
Remote Command:	:CALCulate:CHPower:MARKer:COUple[:STATe] ON OFF 1 0 :CALCulate:CHPower:MARKer:COUple[:STATe] ?
Example:	CALC:CHPower:MARK:COUP ON
Preset:	OFF
State Saved:	Saved in instrument state.
Range:	On Off
Initial S/W Revision:	A.02.00
Help Map ID:	6031

All Markers Off

Turns off all markers.

Key Path:	Marker
Mode:	WCDMA, C2K, WIMAX OFDMA, 1xEVDO, LTE, LTETDD, WLAN
Remote Command:	:CALCulate:CHPower:MARKer:AOff
Example:	CALC:CHP:MARK:AOff
Initial S/W Revision:	Prior to A.02.00
Modified at S/W Revision:	A.02.00, A.03.00
Help Map ID:	6039

Backward Compatibility SCPI Commands

Sets or queries the state of a marker. Setting a marker which is OFF to state ON or 1 puts it in Normal mode and places it at the center of the screen.

Mode:	WCDMA, C2K, WIMAX OFDMA, 1xEVDO, LTE, LTETDD, WLAN
-------	--

Remote Command:	:CALCulate:CHPower:MARKer [1] 2 3 4 5 6 7 8 9 10 11 12 :S TATe OFF ON 0 1 :CALCulate:CHPower:MARKer [1] 2 3 4 5 6 7 8 9 10 11 12 :S TATe?
Example:	CALC:CHP:MARK3:STAT ON CALC:CHP:MARK3:STAT?
Preset:	OFF
State Saved:	Saved in instrument state.
Range:	On Off
Initial S/W Revision:	Prior to A.02.00
Modified at S/W Revision:	A.02.00, A.03.00
Help Map ID:	6040

Marker Function

There are no 'Marker Functions' supported in Channel Power, so this front-panel key displays a blank menu when pressed.

Key Path:	Front-panel key
Initial S/W Revision:	Prior to A.02.00
Help Map ID:	6032

Marker To

There is no 'Marker To' functionality supported in Channel Power measurement, so this front-panel key displays a blank key menu when pressed.

Key Path:	Front-panel key
Initial S/W Revision:	Prior to A.02.00
Help Map ID:	6060

Meas

See Meas@4008@i for more information.

Key Path:	Front-panel key
Help Map ID:	0

Meas Setup

Displays the setup menu for the currently selected measurement. The parameters included in this menu are as follows.

- Averaging
- IF Gain
- Channel Power Span
- Integrated Bandwidth
- Filter Bandwidth
- Root Raised Cosine (RRC) Filter

Key Path:	Front-panel key
Initial S/W Revision:	Prior to A.02.00
Help Map ID:	6050

Avg/Hold Num

Specifies the number of measurement averages used to calculate the measurement result. The average is displayed at the end of each sweep. After the specified number of average counts, the averaging mode (terminal control) setting determines the averaging action.

Key Path:	Meas Setup
Mode:	WCDMA, C2K, WIMAX OFDMA, 1xEVDO, LTE, LTETDD, WLAN
Remote Command:	[:SENSe]:CHPower:AVERage:COUNT <integer> [:SENSe]:CHPower:AVERage:COUNT? [:SENSe]:CHPower:AVERage[:STATe] ON OFF 1 0 [:SENSe]:CHPower:AVERage[:STATe]?
Example:	CHP:AVER:COUN 15 CHP:AVER:COUN? CHP:AVER ON CHP:AVER?
Notes:	You must be in the W-CDMA mode, cdma2000 mode, LTD mode, LTE TDD mode, WLAN mode, 1xEVDO mode, or WIMAX OFDMA mode to use this command. Use :INSTrument:SElect to set the mode.

Channel Power Measurement
Meas Setup

Preset:	WCDMA: 200 WIMAX OFDMA, LTE, LTETDD: 200 CDMA2K: 20 1xEVDO: 20 WLAN: 10 ON
State Saved:	Saved in instrument state.
Min:	1
Max:	10000
Initial S/W Revision:	Prior to A.02.00
Modified at S/W Revision:	A.02.00, A.03.00
Help Map ID:	6012

Avg Mode

Allows you to select the type of termination control used for the averaging function. This determines the averaging action after the specified number of data acquisitions (average count) is reached.

When set to Exponential (Exp) the measurement averaging continues using the specified number of averages to compute each exponentially-weighted averaged value. The average is displayed at the end of each sweep.

When set to Repeat, the measurement resets the average counter each time the specified number of averages is reached.

Key Path:	Meas Setup
Mode:	WCDMA, C2K, WIMAX OFDMA, 1xEVDO, LTE, LTETDD, WLAN
Remote Command:	[:SENSE] :CHPower:AVERage:TCONtrol EXPonential REPeat [:SENSE] :CHPower:AVERage:TCONtrol?
Example:	CHP:AVER:TCON EXP CHP:AVER:TCON?
Notes:	You must be in the W-CDMA mode, cdma2000 mode, LTD mode, LTE TDD mode, WLAN mode, 1xEVDO mode, or WIMAX OFDMA mode to use this command. Use :INSTrument:SELEct to set the mode.
Preset:	EXP
State Saved:	Saved in instrument state.
Range:	Exp Repeat
Initial S/W Revision:	Prior to A.02.00

Modified at S/W Revision:	A.02.00, A.03.00
Help Map ID:	6013

Integ BW

Specifies the range of integration used in calculating the power in the channel. The integration bandwidth (IBW) is displayed on the trace as two markers connected by an arrow.

Key Path:	Meas Setup
Mode:	WCDMA, C2K, WIMAX OFDMA, 1xEVDO, LTE, LTETDD, WLAN
Remote Command:	[:SENSe] :CHPower:BAWdth:INTEgration <bandwidth> [:SENSe] :CHPower:BAWdth:INTEgration?
Example:	CHP:BAW:INT 10MHz CHP:BAW:INT?
Notes:	You must be in the W-CDMA mode, cdma2000 mode, LTD mode, LTE TDD mode, WLAN mode, 1xEVDO mode, or WIMAX OFDMA mode to use this command. Use :INSTrument:SElect to set the mode.
Couplings:	The minimum value of the span is coupled with the integration bandwidth.
Preset:	WCDMA: 5 MHz C2K: 1.23 MHz WIMAX OFDMA: 10 MHz 1xEVDO: 1.23 MHz LTE: 5 MHz LTETDD: 5 MHz WLAN: if Radio Std is 802.11a/g(OFDM/DSSS-OFDM): 20 MHz if Radio Std is 802.11b: 25 MHz if Radio Std is 802.11n(20MHz): 20 MHz if Radio Std is 802.11n(40MHz): 40 MHz if Radio Std is 802.11ac (20 MHz): 20 MHz if Radio Std is 802.11ac (40 MHz): 40 MHz if Radio Std is 802.11ac (80 MHz): 80 MHz if Radio Std is 802.11ac (160 MHz): 160 MHz if Radio Std is 802.11ac (80 MHz + 80 MHz): 80 MHz
State Saved:	Saved in instrument state.
Min:	100 Hz

Channel Power Measurement
Meas Setup

Max:	1 GHz
Max:	RF Input: 1 GHz
Initial S/W Revision:	Prior to A.02.00
Modified at S/W Revision:	A.02.00, A.03.00
Help Map ID:	6014

PhNoise Opt

Selects the LO (local oscillator) phase noise behaviour for various operating conditions.

Key Path:	Meas Setup
Initial S/W Revision:	A.04.20
Help Map ID:	6076

PhNoise Opt Auto

Selects the LO (local oscillator) phase noise behavior to optimize dynamic range and speed for various instrument operating conditions.

The X-Series has two grades of LO; a high performance LO that gives the best phase noise performance; and a medium-performance LO that gives excellent performance.

In models with the high performance LO, Auto will choose:

Fast Tuning whenever Span > 44.44 MHz or RBW > 1.9 MHz

otherwise, if center frequency is < 195 kHz OR ALL of the following are true:

CF 1 MHz AND Span 1.3 MHz AND RBW 75 kHz

then Best Close in Phase Noise;

otherwise, Best Wide-offset Phase Noise

In models with the medium-performance LO, Auto will choose:

Fast Tuning whenever Span > 12.34 MHz or RBW > 250 kHz

otherwise, if center frequency is < 25 kHz OR ALL of the following are true:

CF >= 1 MHz AND Span <= 141.4 kHz AND RBW <= 5 kHz

then **Best Close in Phase Noise**;

otherwise, **Best Wide-offset Phase Noise**

In units whose hardware does not provide for an extra-fast tuning option, the settings for Fast Tuning are the same as Best Close-in, so in those models you will see no difference between these settings.

These rules apply whether in swept spans, zero span, or FFT spans.

Key Path:	Meas Setup
-----------	-------------------

Remote Command:	[:SENSe] :CHPower:FREQuency:SYNTHeSis:AUTO[:STATe] OFF ON 0 1 [:SENSe] :CHPower:FREQuency:SYNTHeSis:AUTO[:STATe] ?
Example:	CHP:FREQ:SYNT:AUTO 1 CHP:FREQ:SYNT:AUTO?
Preset:	OFF
State Saved:	Saved in instrument state.
Range:	Auto Man
Readback Text:	“Auto” is underlined when Auto is selected, otherwise Man is underlined.
Initial S/W Revision:	A.04.20
Help Map ID:	6077

PhNoise Opt State

Selects the LO (local oscillator) phase noise behavior for various operating conditions.

Key Path:	Meas Setup
Remote Command:	[:SENSe] :CHPower:FREQuency:SYNTHeSis[:STATe] 1 2 3 [:SENSe] :CHPower:FREQuency:SYNTHeSis[:STATe] ?
Example:	CHP:FREQ:SYNT 1 CHP:FREQ:SYNT?
Notes:	Parameter key: 1. optimizes phase noise for close-in from the carrier. 2. optimizes phase noise for wide-offset from the carrier. 3. optimizes LO for tuning speed.
Preset:	3
State Saved:	Saved in instrument state.
Range:	Hardware Dependent: PXA: Best Close-in Noise [offset < 140 kHz] Best Wide-offset Noise [offset > 160 kHz] Fast Tuning MXA, EXA: Best Close-in Noise [offset < 20 kHz] Best Wide-offset Noise [offset > 30 kHz] Fast Tuning
Initial S/W Revision:	A.04.20
Help Map ID:	6078

IF Gain

Sets the IF Gain function to Auto, Low Gain or High Gain. These settings affect sensitivity and IF overloads.

Key Path:	Meas Setup
Initial S/W Revision:	Prior to A.02.00
Help Map ID:	6055

IF Gain Auto

Activates the auto rules for IF Gain. When Auto is active, the IF Gain is set to High Gain under any of the following conditions:

- The input attenuator is set to 0 dB
- The preamp is turned On and the frequency range is under 3.6 GHz

For other settings, Auto sets the IF Gain to Low Gain.

Key Path:	Meas Setup, IF Gain
Remote Command:	[:SENSe] :CHPower:IF:GAIN:AUTO [:STATe] ON OFF 1 0 [:SENSe] :CHPower:IF:GAIN:AUTO [:STATe] ?
Example:	CHP:IF:GAIN:AUTO ON CHP:IF:GAIN:AUTO?
Couplings:	When the auto attenuation exists (for example, with an electrical attenuator), IF Gain State differs depending on the condition. Auto sets IF Gain to High Gain under any of the following conditions: The input attenuator is set to 0 dB, or the preamp is turned on and the frequency range is under 3.6 GHz. For other conditions, Auto sets IF Gain to Low Gain.
Preset:	OFF
State Saved:	Saved in instrument state.
Range:	Off On
Initial S/W Revision:	Prior to A.02.00
Help Map ID:	6016

IF Gain State

Selects the range of the IF Gain.

Key Path:	Meas Setup, IF Gain
-----------	----------------------------

Remote Command:	[:SENSE] :CHPower:IF:GAIN[:STATe] ON OFF 1 0 [:SENSE] :CHPower:IF:GAIN[:STATe] ?
Example:	CHP:IF:GAIN ON CHP:IF:GAIN?
Notes:	ON = high gain OFF = low gain
Couplings:	When the auto attenuation exists (for example, with an electrical attenuator), IF Gain State differs depending on the condition. Auto sets IF Gain to High Gain under any of the following conditions: The input attenuator is set to 0 dB, or the preamp is turned on and the frequency range is under 3.6 GHz. For other conditions, Auto sets IF Gain to Low Gain.
Preset:	OFF
State Saved:	Saved in instrument state.
Range:	Low Gain High Gain
Initial S/W Revision:	Prior to A.02.00
Help Map ID:	6017

Method

Turns the Root Raised Cosine (RRC) filter On or Off. The α value (roll off) for the filter is set to the value of the Filter Alpha parameter, and the RRC filter bandwidth is set to the Filter BW parameter.

Key Path:	Meas Setup
Mode:	WCDMA, C2K, WIMAX OFDMA, 1xEVDO, LTE, LTETDD, WLAN
Remote Command:	[:SENSE] :CHPower:FILTer[:RRC] [:STATe] OFF ON 0 1 [:SENSE] :CHPower:FILTer[:RRC] [:STATe] ?
Example:	CHP:FILT OFF CHP:FILT?
Notes:	This parameter is normally used when TETRA is selected as the Radio Std. You must be in the W-CDMA mode, cdma2000 mode, LTD mode, LTE TDD mode, WLAN mode, 1xEVDO mode, or WIMAX OFDMA mode to use this command. Use :INSTrument:SElect to set the mode.
Dependencies:	For CDMA2K mode, this key is blank. For 1xEVDO mode, this key is blank. For WLAN 802.11 ac (80 + 80 MHz), RRC Weighted is not supported .
Preset:	OFF

Channel Power Measurement
Meas Setup

State Saved:	Saved in instrument state.
Range:	Integ BW RRC Weighted
Initial S/W Revision:	Prior to A.02.00
Modified at S/W Revision:	A.02.00, A.03.00, A.10.00
Help Map ID:	6018

Integ BW

See [Method@6018@i](#) for details.

Key Path:	Meas Setup
Initial S/W Revision:	Prior to A.02.00
Modified at S/W Revision:	A.02.00, A.03.00, A.10.00
Help Map ID:	Use 6018

RRC Weighted

See [Method@6018@i](#) for details.

Key Path:	Meas Setup
Initial S/W Revision:	Prior to A.02.00
Modified at S/W Revision:	A.02.00, A.03.00, A.10.00
Help Map ID:	Use 6018

Filter Alpha

Inputs the alpha value for the Root Raised Cosine (RRC) filter.

Key Path:	Meas Setup, Method
Mode:	WCDMA, C2K, WIMAX OFDMA, 1xEVDO, LTE, LTETDD, WLAN
Remote Command:	[:SENSe] :CHPower:FILTer [:RRC] :ALPHa <real> [:SENSe] :CHPower:FILTer [:RRC] :ALPHa?
Example:	CHP:FILT:ALPH 0.5 CHP:FILT:ALPH?
Notes:	This parameter is normally used when TETRA is selected as the Radio Std. You must be in the W-CDMA mode, cdma2000 mode, LTD mode, LTE TDD mode, WLAN mode, 1xEVDO mode, or WIMAX OFDMA mode to use this command. Use :INSTRument:SElect to set the mode.

Dependencies:	For CDMA2K mode, this key is blank. For 1xEVDO mode, this key is blank.
Preset:	WCDMA,,WIMXA OFMDA, LTE, LTETDD, WLAN: 0.22
State Saved:	Saved in instrument state.
Min:	0.01
Max:	1.00
Initial S/W Revision:	Prior to A.02.00
Modified at S/W Revision:	A.02.00, A.03.00, A.10.00
Help Map ID:	6019

Filter BW

Inputs the Root Raised Cosine (RRC) filter bandwidth. Normally, the filter bandwidth is the same as the symbol rate of the signal.

Key Path:	Meas Setup, Method, RRC Weighted
Mode:	WCDMA, C2K, WIMAX OFDMA, 1xEVDO, LTE, LTETDD, WLAN
Remote Command:	[:SENSE] :CHPower:FILTer [:RRC] :BANDwidth <real> [:SENSe] :CHPower:FILTer [:RRC] :BANDwidth?
Example:	CHP:FILT:BAND 10MHz CHP:FILT:BAND?
Notes:	This parameter is normally used when TETRA is selected as the Radio Std. You must be in the W-CDMA mode, cdma2000 mode, LTD mode, LTE TDD mode, WLAN mode, 1xEVDO mode, or WIMAX OFDMA mode to use this command. Use :INSTrument:SElect to set the mode.
Dependencies:	For CDMA2K mode, this key is blank. For 1xEVDO mode, this key is blank.
Preset:	LTE, LTETDD: 3.84MHz WCDMA: 3.84MHz WIMAX OFDMA: 10MHz WLAN: if Radio Std is 802.11a/g(OFDM/DSSS-OFDM): 16.6 MHz if Radio Std is 802.11b: 22 MHz if Radio Std is 802.11n(20MHz): 17.8 MHz if Radio Std is 802.11n(40MHz): 36.6 MHz
State Saved:	Saved in instrument state.

Channel Power Measurement
Meas Setup

Min:	100 Hz
Max:	100 MHz
Backwards Compatibility SCPI:	[:SENSe]:CHPower:FILTer[:RRC]:BWIDth
Initial S/W Revision:	Prior to A.02.00
Modified at S/W Revision:	A.02.00, A.03.00, A.10.00
Help Map ID:	6020

Limits

Accesses the Limits menu that allows you to set up the test limit for channel power or power spectral density.

Key Path:	Meas Setup
Initial S/W Revision:	A.10.00
Help Map ID:	6036

Power Limit

If Power Limit is on, Power Limit is used as threshold which can judge whether the real measured channel power can be passed or not. If real measured channel power exceeds Power Limit, channel power test fails, otherwise, it passes. If Power Limit is off, channel power test is always passed.

Key Path:	Meas Setup, Limits
Mode:	WCDMA, C2K, WIMAX OFDMA, 1xEVDO, LTE, LTETDD, WLAN
Remote Command:	:CALCulate:CHPower:LIMit:POWer <ampl> :CALCulate:CHPower:LIMit:POWer? :CALCulate:CHPower:LIMit:POWer:STATe OFF ON 0 1 :CALCulate:CHPower:LIMit:POWer:STATe?
Example:	CALC:CHP:LIM:POW 16.00 CALC:CHP:LIM:POW? CALC:CHP:LIM:POW:STAT ON CALC:CHP:LIM:POW:STAT?

Notes:	<p>This parameter and PSD Limit can determine Pass/Fail criteria.</p> <p>If ((power limit = On) and (PSD limit= Off))</p> <p>Pass if (power test passes)</p> <p>Fail if (power test fails)</p> <p>If ((power limit = On) and (PSD limit= On))</p> <p>Pass if (both power test and PSD test pass)</p> <p>Fail if (either of power test or PSD test fails)</p> <p>If ((power limit = Off) and (PSD limit= On))</p> <p>Pass if (PSD test passes)</p> <p>Fail if (PSD test fails)</p> <p>If ((power limit = Off) and (PSD limit= Off))</p> <p>Always Pass</p> <p>For WLAN 802.11ac (80 MHz + 80 MHz), the power test and the PSD test are performed to both carriers. Which means the power (or PSD) readouts of both carriers should be compared with the power (or PSD) limit individually, and the test passes only when both values are lower than the limit.</p>
Preset:	<p>16.00</p> <p>WCDMA, C2K, WIMAX OFDMA, 1xEVDO, LTE, LTETDD: OFF</p> <p>WLAN: ON</p>
State Saved:	Saved in instrument state.
Min:	-200.0
Max:	200.0
Initial S/W Revision:	A.10.00
Help Map ID:	6037

Power Limit Fail (remote command only)

The command is query only and used to query if power test passes or fails.

Remote Command:	:CALCulate:CHPower:LIMit:POWer:FAIL?
Example:	CALC:CHP:LIM:POW:FAIL?
Notes:	<p>This command is query only.</p> <p>When Power Limit is off, the returned value is always 0 (pass).</p> <p>When Power Limit is on, the returned value is 0(pass) while power test passes and 1(fail) while power test fails.</p>
Initial S/W Revision:	A.10.00
Help Map ID:	0

PSD Limit

If PSD (power spectral density) Limit is ON, PSD Limit is used as threshold which can judge whether the real measured PSD can be passed or not. If real measured PSD exceeds PSD Limit, PSD test fails, otherwise, it passes. If PSD is off, PSD test is always passed.

Key Path:	Meas Setup, Limits
Mode:	WCDMA, C2K, WIMAX OFDMA, 1xEVDO, LTE, LTETDD, WLAN
Remote Command:	:CALCulate:CHPower:LIMit:PSDensity <real> :CALCulate:CHPower:LIMit:PSDensity? :CALCulate:CHPower:LIMit:PSDensity:STATe OFF ON 0 1 :CALCulate:CHPower:LIMit:PSDensity:STATe?
Example:	CALC:CHP:LIM:PSD 4.00 CALC:CHP:LIM:PSD? CALC:CHP:LIM:POW:STAT ON CALC:CHP:LIM:POW:STAT?
Notes:	This parameter and Power Limit can determine Pass/Fail criteria. If ((power limit = On) and (PSD limit= Off)) Pass if (power test passes) Fail if (power test fails) If ((power limit = On) and (PSD limit= On)) Pass if (both power test and PSD test pass) Fail if (either of power test or PSD test fails) If ((power limit = Off) and (PSD limit= On)) Pass if (PSD test passes) Fail if (PSD test fails) If ((power limit = Off) and (PSD limit= Off)) Always Pass For WLAN 802.11ac (80 MHz + 80 MHz), the power test and the PSD test are performed to both carriers. Which means the PSD (or power) readouts of both carriers should be compared with the PSD (or power) limit individually, and the test passes only when both values are lower than the limit.
Couplings:	The value is automatically converted when PSD Unit is changed.
Preset:	4.00 WCDMA, C2K, WIMAX OFDMA, 1Xevdo, LTE, LTETDD: OFF WLAN: ON
State Saved:	Saved in instrument state.

Min:	-200.0
Max:	200.0
Initial S/W Revision:	A.10.00
Help Map ID:	6081

PSD Limit Fail (remote command only)

The command is query only and used to query if PSD test passes or fails.

Remote Command:	:CALCulate:CHPower:LIMit:PSD:FAIL?
Example:	CALC:CHP:LIM:PSD:FAIL?
Notes:	This command is query only. When PSD Limit is off, the returned value is always 0 (pass). When PSD Limit is on, the returned value is 0(pass) while PSD test passes and 1(fail) while PSD test fails.
Initial S/W Revision:	A.10.00
Help Map ID:	0

PSD Unit

Sets the unit bandwidth for Power Spectral Density. The available units are dBm/Hz and dBm/MHz.

Key Path:	Meas Setup
Mode:	WCDMA, C2K, WIMAX OFDMA, 1xEVDO, LTE, LTETDD, WLAN
Remote Command:	:UNIT:CHPower:POWer:PSD DBMHZ DBMMHZ :UNIT:CHPower:POWer:PSD?
Example:	UNIT:CHP:POW:PSD DBMMHZ UNIT:CHP:POW:PSD?
Couplings:	When the PSD unit is changed, the PSD result of the “MEAS READ FETCH:CHP1?” is also changed by the PSD unit basis (in either dBm/Hz or dBm/MHz).
Preset:	DBMHZ WLAN: DBMMHZ
State Saved:	Saved in instrument state.
Range:	dBm/Hz dBm/MHz
Initial S/W Revision:	Prior to A.02.00
Modified at S/W Revision:	A.02.00, A.03.00

Channel Power Measurement
Meas Setup

Help Map ID:	6025
--------------	------

Meas Preset

Restores all the measurement parameters to their default values.

Key Path:	Meas Setup
Mode:	WCDMA, C2K, WIMAX OFDMA, 1xEVDO, LTE, LTETDD, WLAN
Remote Command:	:CONFIgure:CHPower
Example:	CONF:CHP
Initial S/W Revision:	Prior to A.02.00
Modified at S/W Revision:	A.02.00, A.03.00
Help Map ID:	6021

Mode

See [Key and Command descriptions@2670@i](#) for more information.

Key Path:	Front-panel key
Help Map ID:	0

Mode Setup

See [Mode Setup@\(SA\)4001, \(WCDMA\)4536, \(OFDMA\)20022, \(cdma2000\)26100, \(1xEVDO\)28100, \(DVB-T/H\)31051, \(DTMB\)30851, \(CMMB\)40051, \(ISDB-T\)40250, \(Digital Cable TV\)41901, \(LTE\)28881, \(LTE TDD\)4001, \(WLAN\)45501, \(MSR\)45042](#) for more information.

Key Path:	Front-panel key
Help Map ID:	0

Peak Search

Places the selected marker on the trace point with the maximum y-axis value. Pressing Peak Search with the selected marker Off causes the selected marker to be set to Normal, then a peak search is immediately performed.

Key Path:	Front panel key
Mode:	WCDMA, C2K, WIMAX OFDMA, 1xEVDO, LTE, LTETDD, WLAN
Remote Command:	:CALCulate:CHPower:MARKer [1] 2 3 4 5 6 7 8 9 10 11 12 :M AXimum
Example:	CALC:CHP:MARK2:MAX
Initial S/W Revision:	Prior to A.02.00
Modified at S/W Revision:	A.02.0, A.03.000
Help Map ID:	6042

Recall

See [Recall@\(Key and Command descriptions\)2637, \(LTE\)28892, \(LTETDD\)40472, \(MSR\)45000](#) for more information.

Key Path:	Front-panel key
Initial S/W Revision:	Prior to A.02.00
Help Map ID:	0

Restart

See [Restart@3307@i](#) for more information.

Key Path:	Front-panel key
Help Map ID:	0

Save

See [Save@\(Key and Command Descriptions\)2600, \(MSR\)45003@i](#) for more information.

Key Path:	Front-panel key
Help Map ID:	0

Data

See [Data@2611@i](#) for more information.

Key Path:	Front-panel key
Help Map ID:	0

Measurement Results

Pressing this key selects Meas Results as the data type to be exported.

The Meas Results file contains information which describes the current state of the analyzer. It is detailed in Meas Result File Contents below.

Key Path:	Save, Data
Remote Command:	:MMEMory:STORe:RESults <string>
Example:	:MMEM:STOR:RES "MeasR_0000.csv"
Notes:	<p>If the save is initiated via SCPI and the file already exists, the file will be overwritten.</p> <p>The SCPI command exports Channel Power measurement results to the file specified as the parameter in the current path. The default path is My Documents\<current mode>\data\chp\results.<="" p=""> <p>Using the C: drive is strongly discouraged, since it runs the risk of being overwritten during an instrument software upgrade.</p> <p>The SCPI parameter is a quoted string, which specifies the filename. Both single and double quotes are supported for any filename parameter over SCPI.</p> </current></p>
Dependencies:	The current active measurement must be the Channel Power measurement to use this command.
Status Bits/OPC dependencies:	Sequential – waits for the previous measurement to complete.
Initial S/W Revision:	Prior to A.02.00
Help Map ID:	6085

Meas Results File Contents

A Meas Results File contains measurement results with the following information.

File ID string, which is “MeasResult”

Measurement ID following Mode ID, which is “SA:CHP” for example.

Firmware rev and model number

Option string

Auto Sweep Time Rules

Average Mode

Average Number

Average State

Center Frequency

Detector

IFGain

IFGainAuto

Impedance

Integ BW

Internal Preamp

Internal Preamp Band

PSD Unit

Resolution Band Width

Resolution Bandwidth Shape

RRC Filter Alpha

RRC Filter BW

RRC Filter State

Span

Sweep Points

Sweep Time

Sweep Time Auto

TriggerSource

Video Bandwidth

Y Axis Unit

The file contains these data followed by MeasResult1 and MeasResult2 that flag the start of the measurement results. Each line of Measurement Results consists of two comma separated values, MeasResult1 value and MeasResult2 value. MeasResult1 contains the same results as MEAS/READ/FETCH:CHPower1; MeasResult2, MEAS/READ/FETCH:CHPower2.

Exported file is .csv file. The Meas Results file, when imported into Excel, will show the following data:

MeasResult	
SA:CHP	
A.10.53	N9030A
B25 B40	1
Auto Sweep Time Rules	Normal
Average Mode	Exponential
Average Number	10
Average State	TRUE
Center Frequency	13255000000
Detector	Average
IFGain	FALSE
IFGainAuto	FALSE
Impedance	50
Integ BW	2000000
Internal Preamp	FALSE
Internal Preamp Band	Low
PSD Unit	DbmHz
Resolution Band Width	27000
Resolution Bandwidth Shape	Gaussian
RRC Filter Alpha	0.22
RRC Filter BW	3840000
RRC Filter State	FALSE
Span	3000000
Sweep Points	1001
Sweep Time	0.004933333
Sweep Time Auto	TRUE
TriggerSource	Free
Video Bandwidth	270000
Y Axis Unit	DecibelMilliwatt
MeasResult1	MeasResult2

-76.8141133132837	-95.29174
-139.824413269924	-94.99601
	-94.95281
	-95.17146

Single

See [Single \(Single Measurement/Sweep\)@3515@i](#) for more information.

Key Path:	Front-panel key
Help Map ID:	0

Source (Internal)

Operation of this key is identical across all measurements. For details about this key, see [Source \(Internal\)@35360@i](#).

Key Path:	Front-panel key
Help Map ID:	0

Span X Scale

Accesses a menu of functions that enable you set the horizontal scale parameters.

Key Path:	Front-panel key
Initial S/W Revision:	Prior to A.02.00
Help Map ID:	6044

Span

Changes the frequency range symmetrically about the center frequency.

The default (and minimum) Span is calculated using the number of carriers and the carrier width where;

$$\text{Span} = (\text{Upper Carrier Freq} + (\text{max offset IBW} * (1 + \alpha)) / 2) - (\text{Lower Carrier Freq} - (\text{max offset IBW} * (1 + \alpha)) / 2)$$

The span is increased by a factor of 1 + Filter Alpha if the RRC Filter is on.

Key Path:	Span X Scale
Mode:	WCDMA, C2K, WIMAX OFDMA, 1xEVDO, LTE, LTETDD, WLAN
Remote Command:	[:SENSe] :CHPower:FREQuency:SPAN <freq> [:SENSe] :CHPower:FREQuency:SPAN?
Example:	CHP:FREQ:SPAN 10 MHz CHP:FREQ:SPAN?
Notes:	You must be in the W-CDMA mode, cdma2000 mode, LTD mode, LTE TDD mode, WLAN mode, 1xEVDO mode, or WIMAX OFDMA mode to use this command. Use :INSTrument:SELEct to set the mode.
Dependencies:	For WLAN 802.11ac (80 MHz + 80 MHz), the key is not enabled and its value is coupled with the spacing between the center frequencies of the two carriers. Span = Center Frequency 1 – Center Frequency 2 + Integ BW + 40 MHz Margin. When the calculated span is over 1 GHz, it's still coupled to its maximum value, which is 1 GHz.

Couplings:	<p>When Res BW is set to Auto, the resolution bandwidth is auto-coupled to span. The ratio of span /RBW is approximately 106:1. When the Res BW is set to Man, bandwidths are entered by the user, and these bandwidths are used regardless of other analyzer settings.</p> <p>Since Span is coupled to Integ BW in the factory default condition, if you change the integration bandwidth setting, the span setting changes by a proportional amount until a limit value is reached. However, the span can be individually set. The minimum value of the span is coupled with the integration bandwidth.</p>
Preset:	<p>WCDMA: 7.5 MHz</p> <p>C2K: 1.845 MHz</p> <p>WIMAX OFDMA: 20 MHz</p> <p>1xEVDO: 2.0MHz</p> <p>LTE: 7.5 MHz</p> <p>LTETDD: 7.5 MHz</p> <p>WLAN:</p> <ul style="list-style-type: none"> if Radio Std is 802.11a/g(OFDM/DSSS-OFDM): 30 MHz if Radio Std is 802.11b: 37.5MHz if Radio Std is 802.11n(20MHz): 30 MHz if Radio Std is 802.11n(40MHz): 60 MHz if Radio Std is 802.11ac (20 MHz): 30 MHz if Radio Std is 802.11ac (40 MHz): 60 MHz if Radio Std is 802.11ac (80 MHz): 120 MHz if Radio Std is 802.11ac (160 MHz): 240 MHz if Radio Std is 802.11ac (80 MHz + 80 MHz): 360 MHz
State Saved:	Saved in instrument state.
Min:	100 Hz
Max:	1 GHz
Max:	RF Input: 1 GHz
Initial S/W Revision:	Prior to A.02.00
Modified at S/W Revision:	A.02.00, A.03.00
Help Map ID:	6015

Full Span

Changes the span to show the full frequency range of the spectrum analyzer.

Key Path:	Span X Scale
-----------	---------------------

Channel Power Measurement
Span X Scale

Mode:	WCDMA, C2K, WIMAX OFDMA, 1xEVDO, LTE, LTETDD, WLAN
Remote Command:	[:SENSe] :CHPower :FREQuency :SPAN :FULL
Example:	CHP:FREQ:SPAN:FULL
Notes:	You must be in the W-CDMA mode, cdma2000 mode, LTD mode, LTE TDD mode, WLAN mode, 1xEVDO mode, or WIMAX OFDMA mode to use this command. Use :INSTrument:SElect to set the mode.
Couplings:	Selecting full span changes the measurement span value.
Initial S/W Revision:	Prior to A.02.00
Modified at S/W Revision:	A.02.00, A.03.00
Help Map ID:	6000

Last Span

Changes the span to the previous span setting. If no previous span value exists, then the span remains unchanged.

Key Path:	Span X Scale
Mode:	WCDMA, C2K, WIMAX OFDMA, 1xEVDO, LTE, LTETDD, WLAN
Remote Command:	[:SENSe] :CHPower :FREQuency :SPAN :PREVious
Example:	CHP:FREQ:SPAN:PREV
Notes:	You must be in the W-CDMA mode, cdma2000 mode, LTD mode, LTE TDD mode, WLAN mode, 1xEVDO mode, or WIMAX OFDMA mode to use this command. Use :INSTrument:SElect to set the mode.
Couplings:	Selecting last span changes the measurement span value.
Initial S/W Revision:	Prior to A.02.00
Modified at S/W Revision:	A.02.00, A.03.00
Help Map ID:	6001

Sweep/Control

Accesses a menu of functions that enable you to set up and control the sweep time and source for the current measurement. See [Key and Command Descriptions – Sweep/Control@3273](#) for more information.

Key Path:	Front-panel key
Initial S/W Revision:	Prior to A.02.00
Help Map ID:	6052

Sweep Time

Selects the length of time that the spectrum analyzer sweeps the displayed frequency span. Additional overhead time, which impacts the sweep rate, is not calculated as part of the sweep time. In fact:

- sweep rate = span/sweep time
- update rate = 1/(sweep time + overhead)
- sweep cycle time = sweep time + overhead

Sweep time is coupled to RBW and VBW, and is impacted by the number of sweep points, so changing those parameters may change the sweep time.

Key Path:	Sweep/Control
Mode:	WCDMA, C2K, WIMAX OFDMA, 1xEVDO, LTE, LTETDD, WLAN
Remote Command:	<pre>[:SENSe] :CHPower:SWEep:TIME <time> [:SENSe] :CHPower:SWEep:TIME? [:SENSe] :CHPower:SWEep:TIME:AUTO OFF ON 0 1 [:SENSe] :CHPower:SWEep:TIME:AUTO?</pre>
Example:	<pre>CHP:SWE:TIME 25ms CHP:SWE:TIME? CHP:SWE:TIME:AUTO OFF CHP:SWE:TIME:AUTO?</pre>

Channel Power Measurement
Sweep/Control

Preset:	WIMAX OFDMA: Automatically Calculated WCDMA: 1.0 ms CDMA2K: 9.4ms 1xEVDO: 2.66ms LTE: Automatically Calculated LTETDD: Automatically Calculated WLAN: Automatically Calculated
State Saved:	Saved in instrument state.
Min:	1 ms
Max:	4000 s
Initial S/W Revision:	Prior to A.02.00
Modified at S/W Revision:	A.02.00, A.03.00
Help Map ID:	6023

Sweep Setup

Accesses a menu that enables you to set the sweep state for the current measurement.

Key Path:	Sweep/Control
Initial S/W Revision:	Prior to A.02.00
Help Map ID:	6056

Auto Sweep Time Rules

Switches the analyzer between normal and accuracy sweep states.

Setting **Auto Sweep Time** to **Accy** results in slower sweep times, usually about three times as long, but yields better amplitude accuracy for CW signals. The instrument amplitude accuracy specifications only apply when **Auto Sweep Time** is set to **Accy**.

Additional amplitude errors which occur when **Auto Sweep Time** is set to **Norm** are usually well under 0.1 dB, though this is not guaranteed. Because of the faster sweep times and still low errors, **Norm** is the preferred setting of **Auto Sweep Time**. **Auto Sweep Time** is set to **Norm** on a **Preset** or **Auto Couple**. This means that in the Preset or Auto Coupled state, instrument amplitude accuracy specifications do not apply.

Key Path:	Sweep/Control, Sweep Setup
Mode:	WCDMA, C2K, WIMAX OFDMA, 1xEVDO, LTE, LTETDD, WLAN
Remote Command:	[:SENSE] :CHPower:SWEEp:TIME:AUTO:RULEs NORMal ACCuracy [:SENSE] :CHPower:SWEEp:TIME:AUTO:RULEs?

Example:	CHP:SWE:TIME:AUTO:RUL NORM CHP:SWE:TIME:AUTO:RUL?
Notes:	In Zero Span, this key is irrelevant and inaccessible (because the whole Sweep Setup menu is grayed out in Zero Span), however its settings can be changed remotely with no error indication. Set to Norm when Auto Couple is pressed or sent remotely
Preset:	NORMal
State Saved:	Saved in instrument state.
Range:	Norm Accy
Initial S/W Revision:	Prior to A.02.00
Modified at S/W Revision:	A.02.00, A.03.00
Help Map ID:	6024

Pause

Pauses a measurement after the current data acquisition is complete. When Paused, the label on the key changes to Resume. Pressing the Resume key resumes the measurement at the point it was at when paused. See [Pause/Resume@3290](#) for more details.

Key Path:	Sweep/Control
Initial S/W Revision:	Prior to A.02.00
Help Map ID:	6057

Gate

Accesses a menu that enables you to control the gating function. See [Gate@3292](#) in "Common Measurement Functions" section for more details.

The Gate functionality is used to view signals best viewed by qualifying them with other events.

Key Path:	Sweep/Control
Initial S/W Revision:	Prior to A.02.00
Help Map ID:	6029

Points

Sets the number of points per sweep. The resolution of setting the sweep time depends on the number of points selected. If Preset is selected, the number of points per sweep defaults to 1001. The current value of points is displayed parenthetically, next to the sweep time in the lower-right corner of the display.

Channel Power Measurement
Sweep/Control

Changing the number of points has several effects on the analyzer. Since markers are read at the point location, the marker reading may change. All trace data is cleared.

Key Path:	Sweep/Control
Mode:	WCDMA, C2K, WIMAX OFDMA, 1xEVDO, LTE, LTETDD, WLAN
Remote Command:	[:SENSE] :CHPower:SWEep:POINts <integer> [:SENSE] :CHPower:SWEep:POINts?
Example:	CHP:SWE:POIN 501 CHP:SWE:POIN?
Notes:	Whenever the number of sweep points changes: All trace data is erased Any traces with Update Off also go to Display Off (like going from View to Blank in the older analyzers) Sweep time is re-quantized Any limit lines that are on are updated If averaging/hold is on, averaging/hold starts over
Couplings:	Whenever the number of sweep points changes, the sweep time is re-quantized.
Preset:	Other: 1001 1xEVDO: 512
State Saved:	Saved in instrument state.
Min:	101
Max:	20001
Initial S/W Revision:	Prior to A.02.00
Modified at S/W Revision:	A.02.00, A.03.00
Help Map ID:	6033

Trace/Detector

Accesses a menu of functions that enable you to control the detectors for the current measurement.

Key Path:	Front-panel key
Initial S/W Revision:	Prior to A.02.00
Help Map ID:	6048

Trace Type

Allows you to select the type of trace you want to use for the current measurement. The first page of this menu contains a 1-of-N selection of the trace type (**Clear Write, Average, Max Hold, Min Hold**) for the selected trace.

Key Path:	Trace/Detector
Mode:	WCDMA, C2K, WIMAX OFDMA, 1xEVDO, LTE, LTETDD, WLAN
Remote Command:	:TRACe:CHPower:TYPE WRITe AVERAge MAXHold MINHold :TRACe:CHPower:TYPE?
Example:	TRAC:CHP:TYPE WRIT TRAC:CHP:TYPE?
Notes:	WRITe = Clear Write AVERAge = Average MAXHold = Maximum Hold MINHold = Minimum Hold
Couplings:	When Detector setting is “Auto” (:SENSe]:CHPower:DETEctor:AUTO?), Detector (:SENSe]:CHPower:DETEctor[:FUNCTion]?) switches aligning with the switch of this parameter: “NORMal” with WRITe (Clear Write), “AVERAge” with AVERAge, “POSitive (peak)” with MAXHold, and “NEGative (peak)” with MINHold.
Preset:	AVERAge
State Saved:	Saved in instrument state.
Range:	ClearWrite Average MaxHold MinHold
Initial S/W Revision:	Prior to A.02.00
Modified at S/W Revision:	A.02.00, A.03.00
Help Map ID:	6028

Detector

Accesses a menu of functions that enable you to control the detectors for the current measurement. The following choices are available:

- Auto- the detector selected depends on marker functions, trace functions, average type, and the trace averaging function.
- Normal-the detector determines the peak of the CW-like signals, and it yields alternating maximums and minimums of noise-like signals. This is also referred to as Rosenfell detection.
- Average-the detector determines the average of the signal within the sweep points. The averaging method depends upon the Average Type selection (voltage, power or log scales).
- Peak-the detector determines the maximum of the signal within the sweep points.
- Sample-the detector indicates the instantaneous level of the signal at the center of the sweep points represented by each display point.
- Negative Peak-the detector determines the minimum of the signal within the sweep points.

Key Path:	Detector
Initial S/W Revision:	Prior to A.02.00
Help Map ID:	6058

Detector Selection

Selects a detector to be used by the analyzer for the current measurement.

Key Path:	Trace/Detector
Mode:	WCDMA, C2K, WIMAX OFDMA, 1xEVDO, LTE, LTETDD, WLAN
Remote Command:	[:SENSe] :CHPower:DETEctor [:FUNctIon] NORMal AVERAge POSitive SAMPlE NEGative [:SENSe] :CHPower:DETEctor [:FUNctIon] ?
Example:	CHP:DET NORM CHP:DET?

Notes:	<p>When you manually select a detector (instead of selecting Auto), that detector is used regardless of other analyzer settings.</p> <p>The Normal detector determines the peak of CW-like signals, and it yields alternating maximums and minimums of noise-like signals. This method of detection is also referred to as Rosenfell detection.</p> <p>The Average detector determines the average of the signal within the sweep points. The averaging method is Power Average (RMS).</p> <p>The Peak detector determines the maximum of the signal within the sweep points.</p> <p>The Sample detector indicates the instantaneous level of the signal at the center of the sweep points represented by each display point.</p> <p>The Negative Peak detector determines the minimum of the signal within the sweep points.</p>
Couplings:	When Detector setting is “Auto” ([:SENSe]:CHPower:DETECTOR:AUTO?), Detector ([:SENSe]:CHPower:DETECTOR[:FUNCTION]?) switches aligning with the switch of this parameter: “NORMal” with Clear Write, “AVERAge” with AVERAge, “POSitive (peak)” with MAXHold, and “NEGative (peak)” with MINHold.
Preset:	AVERAge
State Saved:	Saved in instrument state.
Range:	Normal Average Peak Sample Negative Peak
Initial S/W Revision:	Prior to A.02.00
Modified at S/W Revision:	A.02.00, A.03.00
Help Map ID:	6007

Auto

Sets the detector for the currently selected trace to Auto.

Key Path:	Trace/Detector
Mode:	WCDMA, C2K, WIMAX OFDMA, 1xEVDO, LTE, LTETDD, WLAN
Remote Command:	[:SENSe]:CHPower:DETECTOR:AUTO ON OFF 1 0 [:SENSe]:CHPower:DETECTOR:AUTO?
Example:	CHP:DET:AUTO ON CHP:DET:AUTO?
Couplings:	When Detector setting is “Auto” ([:SENSe]:CHPower:DETECTOR:AUTO?), Detector ([:SENSe]:CHPower:DETECTOR[:FUNCTION]?) switches aligning with the switch of this parameter: “NORMal” with Clear Write, “AVERAge” with AVERAge, “POSitive (peak)” with MAXHold, and “NEGative (peak)” with MINHold.

Channel Power Measurement
Trace/Detector

Preset:	ON
State Saved:	Saved in instrument state.
Initial S/W Revision:	Prior to A.02.00
Modified at S/W Revision:	A.02.00, A.03.00
Help Map ID:	6008

Trigger

Accesses a menu of functions that enable you to select and control the trigger source for the current measurement.

See [Key and Command Descriptions@3371](#) for more information.

Key Path:	Front-panel key
Initial S/W Revision:	Prior to A.02.00
Help Map ID:	6051

View/Display

Accesses a menu of functions that enable you to control the instrument display as well as turn the bar graph On and Off.

The results of the measurement can be displayed as a single spectrum trace view or displayed with a Bar Graph trace on the spectrum trace.

Spectrum View with Bar Graph off

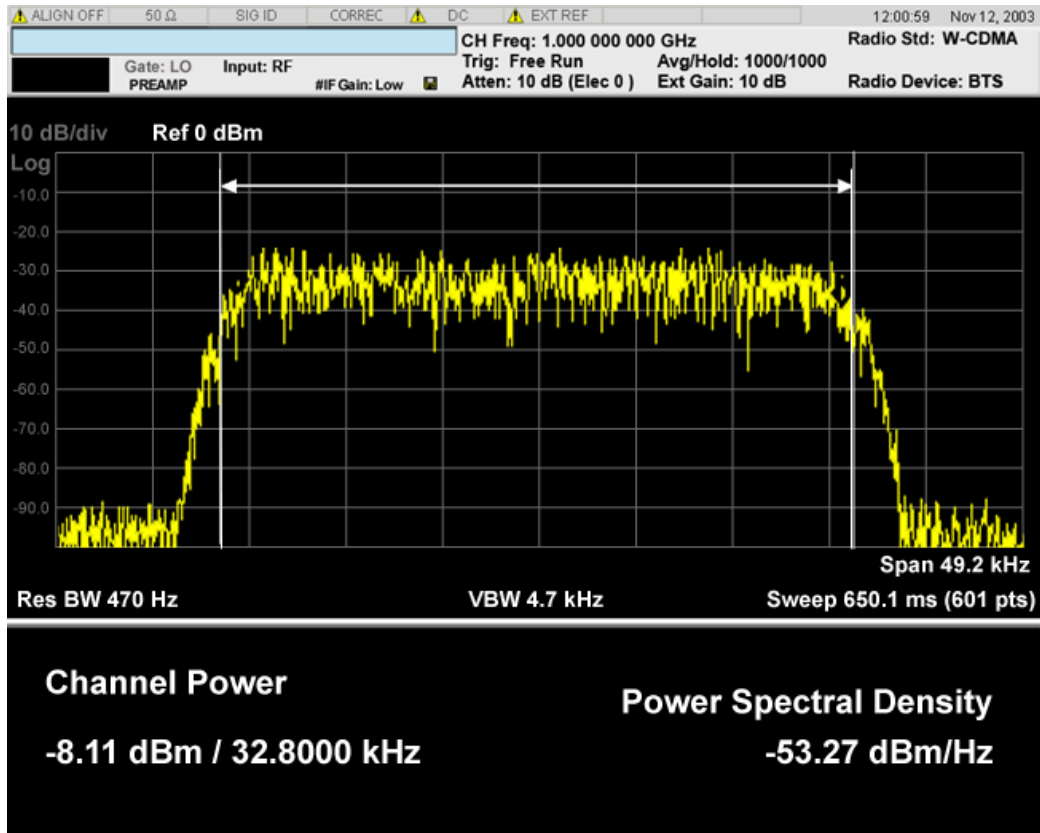

Spectrum View with Bar Graph on

This View is the same as the 'Spectrum' view, but has a blue bar between the markers that indicates the measured output power level. The bar graph is activated when the "Bar Graph" Soft Key is set to ON under the View/Display menu. The actual measured output power level is displayed on the display at the bottom of the bar.

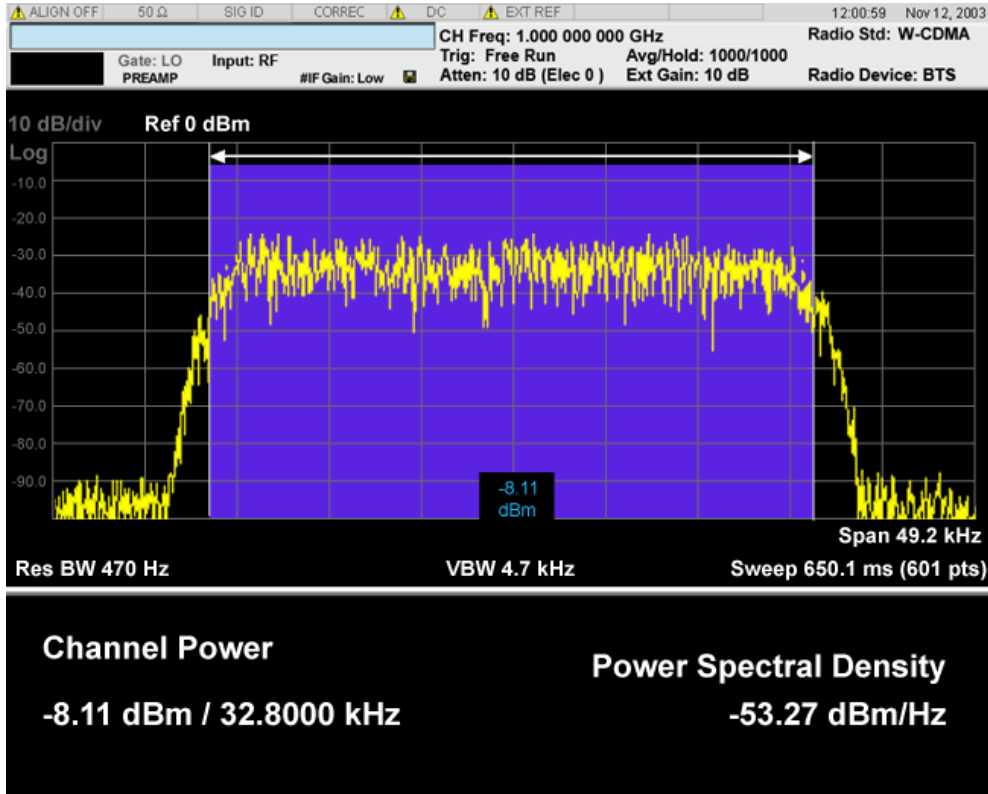

If the current mode is WLAN and the format is WLAN 802.11ac 80+80 MHz, the spectrum view is changed a little so that the results of both carrier segments can be displayed.

Spectrum View with Bar Graph off for WLAN 802.11ac (80 + 80 MHz):

Channel Power Measurement
View/Display

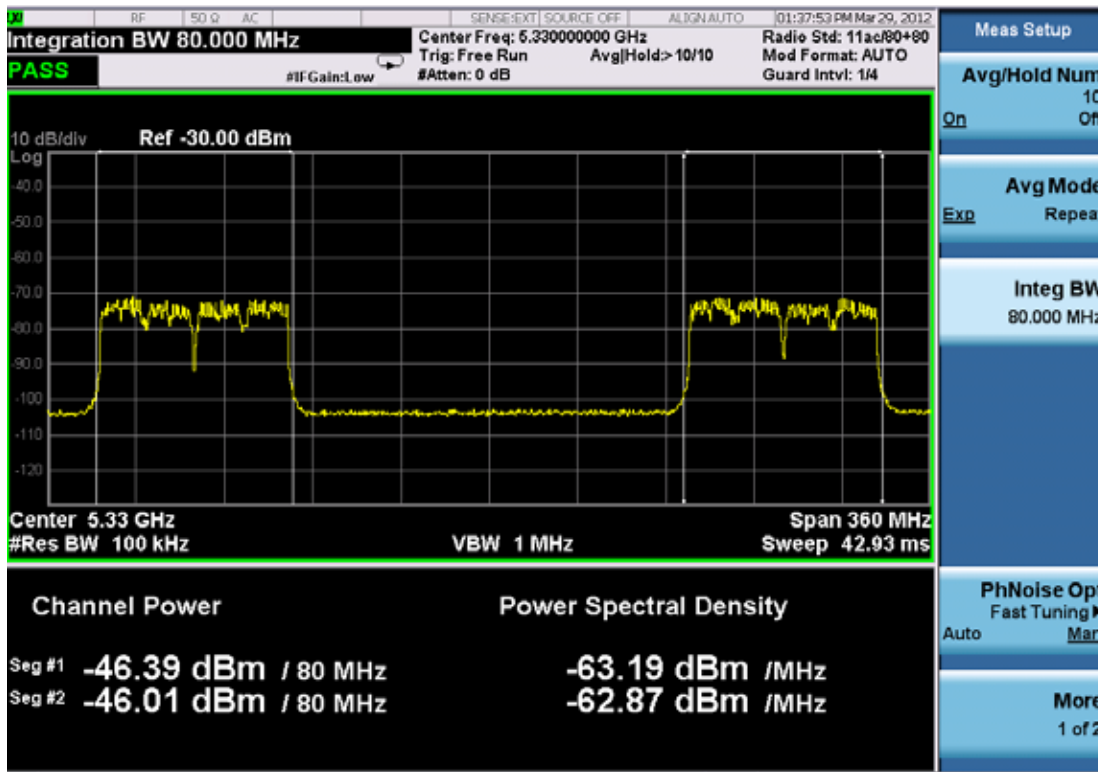

Spectrum View with Bar Graph on for WLAN 802.11ac (80 + 80 MHz):

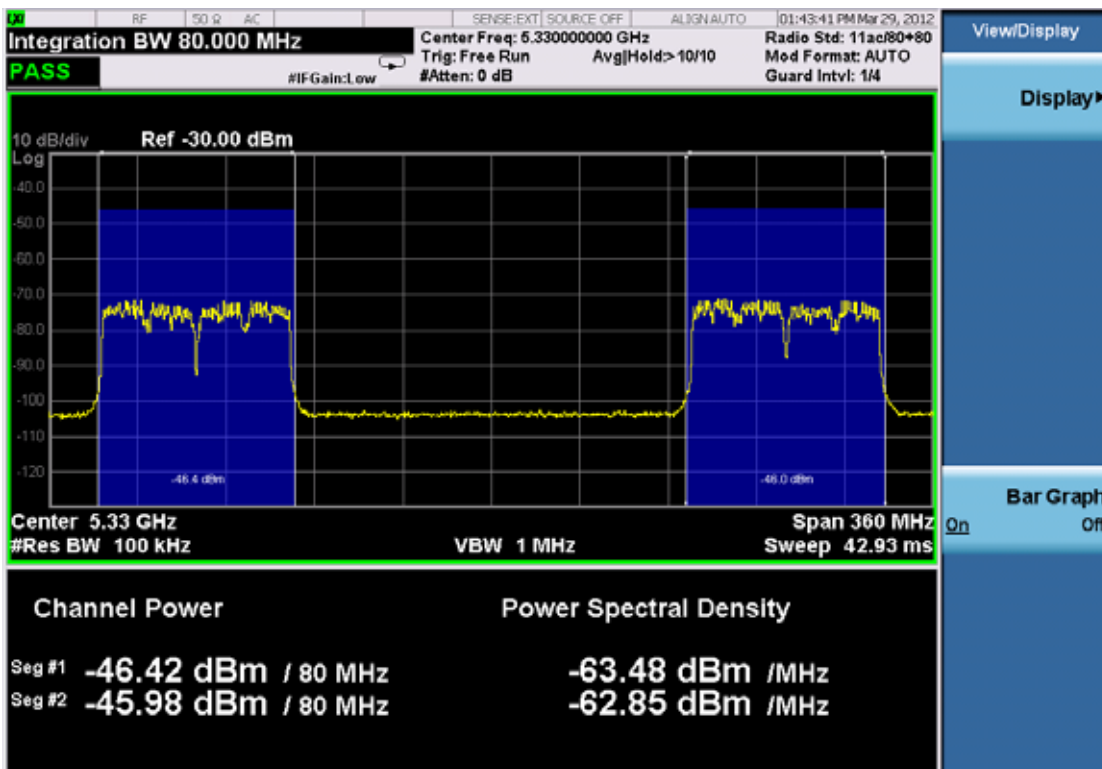

Power Results:

The spectrum trace and power bars are displayed in the upper window. Total carrier power, total PSD and total format carrier power are displayed in the lower window. Total format carrier power is total power of carriers of the same Radio Format. If there is no carrier of the corresponding format, it is not displayed. Thus items in the total format power table changes depending on the carrier configuration.

Carrier Info:

The lower window of Power Results view is replaced by the carrier info table in this view. Carrier center frequency can be displayed in either offset or absolute frequency depending on Carrier Freq. The table can be scrolled by Carrier Result on Meas Setup menu or by Select Carrier on Config Carriers menu. The highlighted row changes as either Carrier Result or Select Carrier is changed. The highlighted row and these keys are not coupled.

Key Path:	Front-panel key
Initial S/W Revision:	Prior to A.02.00
Help Map ID:	6046

Display

Accesses a menu of functions that enable you to set the display parameters.

See [Display@3440](#) for more information.

Key Path:	View/Display
Initial S/W Revision:	Prior to A.02.00
Help Map ID:	6047

Bar Graph

Turns the Bar Graph On and Off.

Key Path:	View/Display
Mode:	WCDMA, C2K, WIMAX OFDMA, 1xEVDO, LTE, LTETDD, WLAN
Remote Command:	:DISPlay:CHPower:VIEW [1] :WINDow [1] :BGRaph ON OFF 1 0 :DISPlay:CHPower:VIEW [1] :WINDow [1] :BGRaph?
Example:	DISP:CHP:VIEW:WIND:BGR ON DISP:CHP:VIEW:WIND:BGR?
Notes:	You must be in the W-CDMA mode, cdma2000 mode, LTD mode, LTE TDD mode, WLAN mode, 1xEVDO mode, or WIMAX OFDMA mode to use this command. Use :INSTrument:SElect to set the mode.
Preset:	OFF
State Saved:	Saved in instrument state.

Channel Power Measurement
View/Display

Range:	On Off
Initial S/W Revision:	Prior to A.02.00
Modified at S/W Revision:	A.02.00, A.03.00
Help Map ID:	6006

The Occupied Bandwidth measurement computes and displays the bandwidth occupied by a given percentage of the total mean power of a signal. For measurement results and views, see [“View/Display” on page 452](#).

This topic contains the following sections:

[“Remote Commands for Occupied Bandwidth” on page 399](#)

[“Remote Command Results for Occupied Bandwidth Measurement” on page 399](#)

Remote Commands for Occupied Bandwidth

The following commands and queries can be used to retrieve the measurement results:

```
:CONFigure:OBWidth
:CONFigure:OBWidth:NDEFault
:INITiate:OBWidth
:FETCh:OBWidth [n] ?
:MEASure:OBWidth [n] ?
:READ:OBWidth [n] ?
:FETCh:OBWidth:OBWidth?
:MEASure:OBWidth:OBWidth?
:READ:OBWidth:OBWidth?
:FETCh:OBWidth:FERRor?
:MEASure:OBWidth:FERRor?
:READ:OBWidth:FERRor?
:FETCh:OBWidth:XDB?
:MEASure:OBWidth:XDB?
:READ:OBWidth:XDB?
```

See also the section, [Remote Measurement Functions@29978](#).

Remote Command Results for Occupied Bandwidth Measurement

The following table describes the results returned by the FETCh:OBWidth[n]?, MEASure:OBWidth[n]?,

Occupied Bandwidth Measurement

and READ:OBWidth[n]? queries listed above, according to the index value n.

n	Results Returned
n=1 (or not specified)	Returns 7 scalar results, in the following order: <ol style="list-style-type: none">1. Occupied bandwidth – Hz2. Total Power – dBm (Total Power will be obsolete in TD-SCDMA mode, this place will be replaced by NaN)3. Span - Hz4. Spectrum Trace Points - points5. Res BW – Hz6. Transmit Frequency Error Hz7. x DB Bandwidth - Hz
2	Returns the frequency-domain spectrum trace (data array) for the entire frequency range being measured.

Key Path:	Meas
Initial S/W Revision:	Prior to A.02.00
Help Map ID:	6544

AMPTD Y Scale (Amplitude/Y Scale)

Activates the Reference Value function and displays the Amplitude menu keys. These functions control how data on the vertical (Y) axis is displayed and control instrument settings that affect the vertical axis

See [AMPTD Y Scale@3001](#) for more information.

Key Path:	Front-panel key
Initial S/W Revision:	Prior to A.02.00
Help Map ID:	6546

Ref Value

Sets the absolute power reference value. However, since the Auto Scaling is defaulted to On, this value is automatically determined by the measurement result. When you set a value manually, Auto Scaling automatically changes to Off.

Key Path:	AMPTD Y Scale
Mode:	WCDMA, C2K, WIMAX OFDMA, TD-SCDMA, 1xEVDO, LTE, LTETDD, BLUETOOTH, WLAN
Remote Command:	:DISPlay:OBWidth:VIEW[1]:WINDow[1]:TRACe:Y[:SCALe]:RLEV el <real> :DISPlay:OBWidth:VIEW[1]:WINDow[1]:TRACe:Y[:SCALe]:RLEV el?
Example:	DISP:OBW:VIEW:WIND:TRAC:Y:RLEV 125 DISP:OBW:VIEW:WIND:TRAC:Y:RLEV?
Notes:	You must be in the W-CDMA mode, cdma2000 mode, TD-SCDMA mode, BLUETOOTH mode, LTE mode, LTE TDD mode, WLAN mode, 1xEVDO mode, or WIMAX OFDMA mode to use this command. Use:INSTrument:SElect to set the mode.
Couplings:	When the Auto Scaling is On, this value is automatically determined by the measurement result. When you set a value manually, Auto Scaling automatically changes to Off.
Preset:	10.00 dBm
State Saved:	Saved in instrument state.
Min:	-250.00 dBm
Max:	250.00 dBm
Initial S/W Revision:	Prior to A.02.00
Modified at S/W Revision:	A.03.00

Help Map ID:	6503
--------------	------

Attenuation

Accesses a menu of functions that enable you to change the attenuation settings. This key has read-back text that describes the total attenuator value.

See [Attenuation@3003](#) for more information.

Key Path:	AMPTD Y Scale
Initial S/W Revision:	Prior to A.02.00
Help Map ID:	6561

Scale/Div

Sets the logarithmic units per vertical graticule division on the display. When the Auto Scaling is On, the Scale/Div is automatically determined by the measurement result. When you set a value manually, Auto Scaling is automatically toggled to Off.

Key Path:	AMPTD Y Scale
Mode:	WCDMA, C2K, WIMAX OFDMA, TD-SCDMA, 1xEVDO, LTE, LTETDD, BLUETOOTH, WLAN
Remote Command:	:DISPlay:OBWidth:VIEW[1]:WINDow[1]:TRACe:Y[:SCALE]:PDIVision <rel_ampl> :DISPlay:OBWidth:VIEW[1]:WINDow[1]:TRACe:Y[:SCALE]:PDIVision?
Example:	DISP:OBW:VIEW:WIND:TRAC:Y:PDIV 5 DISP:OBW:VIEW:WIND:TRAC:Y:PDIV?
Notes:	You must be in the W-CDMA mode, cdma2000 mode, TD-SCDMA mode, BLUETOOTH mode, LTE mode, LTE TDD mode, WLAN mode, 1xEVDO mode, or WIMAX OFDMA mode to use this command. Use:INSTrument:SELEct to set the mode.
Couplings:	When the Auto Scaling is On, this value is automatically determined by the measurement result. When you set a value manually, Auto Scaling automatically changes to Off.
Preset:	10.00 dB
State Saved:	Saved in instrument state.
Min:	0.10 dB
Max:	20.00 dB
Initial S/W Revision:	Prior to A.02.00

Modified at S/W Revision:	A.03.00
Help Map ID:	6504

Y Axis Unit

Allows you to change the vertical (Y) axis amplitude unit.

See [Y Axis Unit@3021@i](#) under AMPTD Y Scale for more information.

Key Path:	AMPTD/Y Scale
Initial S/W Revision:	A.04.00
Help Map ID:	0

Internal Preamp

Accesses a menu of functions that enable you to control the internal preamplifiers.

See [Internal Preamp@3036](#) for more information.

Key Path:	AMPTD Y Scale
Initial S/W Revision:	Prior to A.02.00
Help Map ID:	6562

Ref Position

Positions the reference level at the top, center or bottom of the Y Scale display. Changing the reference position does not change the reference level value.

Key Path:	AMPTD Y Scale
Mode:	WCDMA, C2K, WIMAX OFDMA, TD-SCDMA, 1xEVDO, LTE, LTETDD, BLUETOOTH, WLAN
Remote Command:	:DISPlay:OBWidth:VIEW[1]:WINDow[1]:TRACe:Y[:SCALE]:RPOSITION TOP CENTER BOTTom :DISPlay:OBWidth:VIEW[1]:WINDow[1]:TRACe:Y[:SCALE]:RPOSITION?
Example:	DISP:OBW:VIEW:WIND:TRAC:Y:RPOS BOTT DISP:OBW:VIEW:WIND:TRAC:Y:RPOS?
Notes:	You must be in the W-CDMA mode, cdma2000 mode, TD-SCDMA mode, BLUETOOTH mode, LTE mode, LTE TDD mode, WLAN mode, 1xEVDO mode, or WIMAX OFDMA mode to use this command. Use:INSTrument:SElect to set the mode.
Preset:	TOP

Occupied Bandwidth Measurement
AMPTD Y Scale (Amplitude/Y Scale)

State Saved:	Saved in instrument state.
Range:	Top Ctr Bot
Initial S/W Revision:	Prior to A.02.00
Modified at S/W Revision:	A.03.00
Help Map ID:	6505

Auto Scaling

Allows you to toggle the Auto Scaling function between On and Off.

Key Path:	AMPTD Y Scale
Mode:	WCDMA, C2K, WIMAX OFDMA, TD-SCDMA, 1xEVDO, LTE, LTETDD, BLUETOOTH, WLAN
Remote Command:	:DISPlay:OBWidth:VIEW[1]:WINDow[1]:TRACe:Y[:SCALE]:COUP le 0 1 OFF ON :DISPlay:OBWidth:VIEW[1]:WINDow[1]:TRACe:Y[:SCALE]:COUP le?
Example:	DISP:OBW:VIEW:WIND:TRAC:Y:COUP ON DISP:OBW:VIEW:WIND:TRAC:Y:COUP?
Couplings:	When Auto Scaling is On, upon pressing the Restart front-panel key, this function automatically sets the scale per division to 10 dB and determines reference values based on the measurement results. When you set a value to either Scale/Div or Ref Value manually, Auto Scaling automatically changes to Off.
Preset:	1
State Saved:	Saved in instrument state.
Range:	On Off
Initial S/W Revision:	Prior to A.02.00
Modified at S/W Revision:	A.03.00
Help Map ID:	6506

Auto Couple

The Auto Couple function is not supported in this measurement.

Key Path:	Front-panel key
Initial S/W Revision:	Prior to A.02.00
Help Map ID:	0

BW

Accesses a menu of functions that enable you to specify and control the video and resolution bandwidths. You can also select the type of filter for the measurement.

Key Path:	Front-panel key
Initial S/W Revision:	Prior to A.02.00
Help Map ID:	6550

Res BW

Sets the resolution bandwidth for the current measurement. If an unavailable bandwidth is entered with the numeric keypad, the closest available bandwidth is selected.

Key Path:	BW
Mode:	WCDMA, C2K, WIMAX OFDMA, TD-SCDMA, 1xEVDO, LTE, LTETDD, BLUETOOTH, WLAN
Remote Command:	[:SENSE]:OBWidth:BANDwidth[:RESolution] <bandwidth> [:SENSE]:OBWidth:BANDwidth[:RESolution]? [:SENSE]:OBWidth:BANDwidth[:RESolution]:AUTO ON OFF 1 0 [:SENSE]:OBWidth:BANDwidth[:RESolution]:AUTO?
Example:	OBW:BAND 250000 OBW:BAND? OBW:BAND:AUTO OFF OBW:BAND:AUTO?
Notes:	You must be in the W-CDMA mode, cdma2000 mode, TD-SCDMA mode, BLUETOOTH mode, LTE mode, LTE TDD mode, WLAN mode, 1xEVDO mode, or WIMAX OFDMA mode to use this command. Use:INSTrument:SElect to set the mode.
Couplings:	Sweep time is coupled to RBW. As the RBW changes, the sweep time (if set to Auto) is changed to maintain amplitude calibration. Video bandwidth (VBW) is coupled to RBW. As the resolution bandwidth changes, the video bandwidth (if set to Auto) changes to maintain the ratio of VBW/RBW (10:1). When Res BW is set to Auto, the resolution bandwidth is auto-coupled to span. The ratio of Span/RBW is approximately 106:1 when auto coupled. When Res BW is set to Man, bandwidths are entered manually, and these bandwidths are used regardless of other analyzer settings.

Preset:	WCDMA: 30 kHz CDMA2K: 12 kHz WIMAX OFDMA: 100 kHz TD-SCDMA: 30 kHz 1xEVDO: 30 kHz LTE: 30 kHz LTETDD: 30 kHz BLUETOOTH:10 kHz WLAN: 100kHz WCDMA, C2K,TD-SCDMA,WIMAX OFDMA, 1xEVDO, LTE, LTETDD, WLAN: OFF
State Saved:	Saved in instrument state.
Min:	1 Hz
Max:	8 MHz
Backwards Compatibility SCPI:	[:SENSe]:OBWidth:BWIDth[:RESolution]
Initial S/W Revision:	Prior to A.02.00
Modified at S/W Revision:	A.03.00
Help Map ID:	6509

Video BW

Changes the analyzer post-detection filter.

Key Path:	BW
Mode:	WCDMA, C2K, WIMAX OFDMA, TD-SCDMA, 1xEVDO, LTE, LTETDD, BLUETOOTH, WLAN
Remote Command:	[:SENSe]:OBWidth:BANDwidth:VIDeo <bandwidth> [:SENSe]:OBWidth:BANDwidth:VIDeo? [:SENSe]:OBWidth:BANDwidth:VIDeo:AUTO ON OFF 1 0 [:SENSe]:OBWidth:BANDwidth:VIDeo:AUTO?
Example:	OBW:BAND:VID 5 MHz OBW:BAND:VID? OBW:BAND:VID:AUTO ON OBW:BAND:VID:AUTO?

Occupied Bandwidth Measurement
BW

Notes:	You must be in the W-CDMA mode, cdma2000 mode, TD-SCDMA mode, BLUETOOTH mode, LTE mode, LTE TDD mode, WLAN mode, 1xEVDO mode, or WIMAX OFDMA mode to use this command. Use:INSTRument:SElect to set the mode.
Dependencies:	When using the average detector with either Sweep Time set to Man, or in zero span, the VBW setting has no effect and is disabled (grayed out).
Couplings:	<p>Video bandwidth (VBW) is coupled to RBW. As the resolution bandwidth changes, the video bandwidth (if set to Auto) changes to maintain the ratio set by VBW/RBW.</p> <p>Sweep Time is coupled to Video Bandwidth (VBW). As the VBW is changed, the sweep time (when set to Auto) is changed to maintain amplitude calibration. This occurs because of common hardware between the two circuits, even though the Video BW filter is not actually “in-circuit” when the detector is set to Average. Because the purpose of the average detector and the VBW filter are the same, either can be used to reduce the variance of the result.</p> <p>Although the VBW filter is not “in-circuit” when using the average detector, the Video BW key can have an effect on (Auto) sweep time, and is not disabled. In this case, reducing the VBW setting increases the sweep time, which increases the averaging time, producing a lower-variance trace.</p> <p>When the video bandwidth is AUTO coupled, the video bandwidth value is set to: Resolution Bandwidth * Video Bandwidth to Resolution Bandwidth Ratio</p>
Preset:	LTE, LTETDD, WLAN: Auto WCDMA: 300 kHz CDMA2K:120 kHz WIMAX OFDMA: 1 MHz TD-SCDMA: 300 kHz 1xEVDO: 300 kHz BLUETOOTH: 30 kHz ON
State Saved:	Saved in instrument state.
Min:	1 Hz
Max:	50 MHz
Backwards Compatibility SCPI:	[:SENSe]:OBWidth:BWIDth:VIDeo
Initial S/W Revision:	Prior to A.02.00
Modified at S/W Revision:	A.03.00
Help Map ID:	6510

Filter Type

Allows you to select the type of filter to be used for the current measurement. Besides the Gaussian filter shape, there are certain special filter types, such as Flat Top, that are desirable under certain conditions.

Key Path:	BW
Mode:	WCDMA, C2K, WIMAX OFDMA, TD-SCDMA, 1xEVDO, LTE, LTETDD, BLUETOOTH, WLAN
Remote Command:	[:SENSe] :OBWidth:BAWdwidth:SHAPE GAUSSian FLATtop [:SENSe] :OBWidth:BAWdwidth:SHAPE?
Example:	OBW:BAWd:SHAP GAUS OBW:BAWd:SHAP?
Preset:	GAUSSian
State Saved:	Saved in instrument state.
Range:	Gaussian Flattop
Backwards Compatibility SCPI:	[:SENSe]:OBWidth:BWIDth:SHAPE
Initial S/W Revision:	Prior to A.02.00
Modified at S/W Revision:	A.03.00
Help Map ID:	6511

Cont (Continuous)

See Cont@3309@i for more information.

Key Path:	Front-panel key
Initial S/W Revision:	Prior to A.02.00
Help Map ID:	0

FREQ/Channel (Frequency or Channel)

See [FREQ Channel@\(SA, LTE, LTE TDD, OFDMA, WLAN, TD-SCDMA, 1xEVDO\)3057, \(WCDMA\)4564, \(cdma2000\)26103, \(CMMB\)40063, \(ISDB-T\)40276, \(BLUETOOTH\)35871, \(MSR\)45070](#) for more information.

Key Path:	Front-panel key
Initial S/W Revision:	Prior to A.02.00
Help Map ID:	0

Input/Output

See [Input/Output@3065](#) for more information.

Key Path:	Front-panel key
Initial S/W Revision:	Prior to A.02.00
Help Map ID:	0

Marker

Accesses a menu that enables you to select, set up and control the markers for the current measurement.

Key Path:	Front-panel key
Initial S/W Revision:	Prior to A.02.00
Help Map ID:	6558

Select Marker

Displays the menu keys that enable you to select, set up and control the markers for the current measurement

Key Path:	Marker
Initial S/W Revision:	Prior to A.02.00
Help Map ID:	6524

Marker X Axis Value (Remote Command Only)

Sets the marker X Axis value in the current marker X Axis Scale unit. It has no effect if the control mode is **Off**.

Key Path:	SCPI only
Mode:	WCDMA, C2K, WIMAX OFDMA, TD-SCDMA, 1xEVDO, LTE, LTETDD, BLUETOOTH, WLAN
Remote Command:	:CALCulate:OBWidth:MARKer [1] 2 3 4 5 6 7 8 9 10 11 12 :X <freq> :CALCulate:OBWidth:MARKer [1] 2 3 4 5 6 7 8 9 10 11 12 :X ?
Example:	CALC:OBW:MARK3:X 0 CALC:OBW:MARK3:X?
Notes:	The query returns the marker's absolute X Axis value if the control mode is Normal , or the offset from the marker's reference marker if the control mode is Delta . The query is returned in the fundamental units for the current marker X Axis scale: Hz for Frequency .
Preset:	After a preset, all markers are turned OFF, so Marker X Axis Value query returns a not a number (NAN).
State Saved:	No
Min:	-9.9E+37

Max:	9.9E+37
Initial S/W Revision:	Prior to A.02.00
Modified at S/W Revision:	A.03.00
Help Map ID:	0

Marker X Axis Position (Remote Command Only)

Sets the marker X position in trace points. It has no effect if the control mode is **Off**.

Key Path:	SCPI only
Mode:	WCDMA, C2K, WIMAX OFDMA, TD-SCDMA, 1xEVDO, LTE, LTETDD, BLUETOOTH, WLAN
Remote Command:	:CALCulate:OBwidth:MARKer [1] 2 3 4 5 6 7 8 9 10 11 12 :X :POSition <real> :CALCulate:OBwidth:MARKer [1] 2 3 4 5 6 7 8 9 10 11 12 :X :POSition?
Example:	CALC:OBW:MARK10:X:POS 0 CALC:OBW:MARK10:X:POS?
Notes:	The query returns the marker's absolute X Axis value in trace points if the control mode is Normal , or the offset from the marker's reference marker in trace points if the control mode is Delta .
Preset:	After a preset, all markers are turned OFF, so Marker X Axis Value query returns a not a number (NAN).
State Saved:	No
Min:	-9.9E+37
Max:	9.9E+37
Initial S/W Revision:	Prior to A.02.00
Modified at S/W Revision:	A.03.00
Help Map ID:	0

Marker Y Axis Value (Remote Command Only)

Returns the marker Y Axis value in the current marker Y Axis unit.

Key Path:	SCPI only
Mode:	WCDMA, C2K, WIMAX OFDMA, TD-SCDMA, 1xEVDO, LTE, LTETDD, BLUETOOTH, WLAN
Remote Command:	:CALCulate:OBwidth:MARKer [1] 2 3 4 5 6 7 8 9 10 11 12 :Y ?

Example:	CALC:OBW:MARK11:Y?
Preset:	Result dependent on Markers setup and signal source.
State Saved:	No
Min:	-9.9E+37
Max:	9.9E+37
Initial S/W Revision:	Prior to A.02.00
Modified at S/W Revision:	A.03.00
Help Map ID:	0

Marker Type

Sets the marker control mode to **Normal**, **Delta** or **Off**. If the selected marker is Off, pressing Marker sets it to Normal and places a single marker at the center of the display. At the same time, **Marker X Axis Value** appears on the Active Function area.

Key Path:	Marker
Mode:	WCDMA, C2K, WIMAX OFDMA, TD-SCDMA, 1xEVDO, LTE, LTETDD, BLUETOOTH, WLAN
Remote Command:	:CALCulate:OBWidth:MARKer [1] 2 3 4 5 6 7 8 9 10 11 12 :M ODE POSition DELTA OFF :CALCulate:OBWidth:MARKer [1] 2 3 4 5 6 7 8 9 10 11 12 :M ODE?
Example:	CALC:OBW:MARK:MODE POS CALC:OBW:MARK:MODE?
Notes:	If the selected marker is Off, pressing Marker sets it to Normal and places it at the center of the screen on the trace determined by the Marker Trace rules. At the same time, Marker X Axis Value appears on the Active Function area. Default Active Function: the active function for the selected marker's current control mode. If the current control mode is Off, there is no active function and the active function is turned off. Active Function Display: the marker X axis value entered in the active function area displays the marker value to its full entered precision.
Preset:	OFF
State Saved:	Saved in instrument state.
Range:	Normal Delta Off
Initial S/W Revision:	Prior to A.02.00
Modified at S/W Revision:	A.03.00
Help Map ID:	6533

Properties

Accesses the marker properties menu.

Key Path:	Marker
Initial S/W Revision:	Prior to A.02.00
Help Map ID:	6563

Select Marker

Displays 12 markers available for selection.

Key Path:	Marker, Properties
Initial S/W Revision:	Prior to A.02.00
Help Map ID:	6525

Relative To

Selects the desired marker. The selected marker will be relative to its reference marker.

Key Path:	Marker, Properties
Mode:	WCDMA, C2K, WIMAX OFDMA, TD-SCDMA, 1xEVDO, LTE, LTETDD, BLUETOOTH, WLAN
Remote Command:	:CALCulate:OBwidth:MARKer [1] 2 3 4 5 6 7 8 9 10 11 12 :R EFerence <integer> :CALCulate:OBwidth:MARKer [1] 2 3 4 5 6 7 8 9 10 11 12 :R EFerence?
Example:	CALC:OBW:MARK:REF 2 CALC:OBW:MARK:REF?
Notes:	A marker cannot be relative to itself so that choice is grayed out, and if sent from SCPI generates error -221: "Settings conflict; marker cannot be relative to itself." When queried a single value is returned (the specified marker numbers relative marker). You must be in the W-CDMA mode, cdma2000 mode, TD-SCDMA mode, BLUETOOTH mode, LTE mode, LTE TDD mode, WLAN mode, 1xEVDO mode, or WIMAX OFDMA mode to use this command. Use:INSTRument:SElect to set the mode.
Preset:	2 3 4 5 6 7 8 9 10 11 12 1
State Saved:	Saved in instrument state.
Min:	1
Max:	12

Readback:	Current selected relative to marker number.
Initial S/W Revision:	Prior to A.02.00
Modified at S/W Revision:	A.03.00
Help Map ID:	6537

All Markers Off

Turns off all markers.

Key Path:	Marker
Mode:	WCDMA, C2K, WIMAX OFDMA, TD-SCDMA, 1xEVDO, LTE, LTETDD, BLUETOOTH, WLAN
Remote Command:	:CALCulate:OBWidth:MARKer:AOFF
Example:	CALC:OBW:MARK:AOFF
Initial S/W Revision:	Prior to A.02.00
Modified at S/W Revision:	A.03.00
Help Map ID:	6538

Backward Compatibility SCPI Commands

Sets or queries the state of a marker. Setting a marker which is OFF to state ON or 1 puts it in **Normal** mode and places it at the center of the screen.

Key Path:	SCPI only
Mode:	WCDMA, C2K, WIMAX OFDMA, TD-SCDMA, 1xEVDO, LTE, LTETDD, BLUETOOTH, WLAN
Remote Command:	:CALCulate:OBWidth:MARKer [1] 2 3 4 5 6 7 8 9 10 11 12 : S TATe OFF ON 0 1 :CALCulate:OBWidth:MARKer [1] 2 3 4 5 6 7 8 9 10 11 12 : S TATe?
Example:	CALC:OBW:MARK3:STAT ON CALC:OBW:MARK3:STAT?
Preset:	OFF
State Saved:	Saved in instrument state.
Initial S/W Revision:	Prior to A.02.00
Modified at S/W Revision:	A.03.00
Help Map ID:	0

Marker Function

There are no 'Marker Functions' supported in this measurement. When pressed, this key displays a blank menu.

Key Path:	Front panel key
Initial S/W Revision:	Prior to A.02.00
Help Map ID:	6542

Marker To

There is no 'Marker To' functionality supported in this measurement. When pressed, this key displays a blank menu.

Key Path:	Front panel key
Initial S/W Revision:	Prior to A.02.00
Help Map ID:	6541

Meas

See Meas@4008@i for more information.

Key Path:	Front-panel key
Initial S/W Revision:	Prior to A.02.00
Help Map ID:	0

Meas Setup

Displays the setup menu for the current measurement. The measurement setup parameters include the number of measurement averages used to calculate the measurement result and the averaging mode. The setup menu also includes the option to reset the measurement settings to their factory defaults.

Key Path:	Front-panel key
Initial S/W Revision:	Prior to A.02.00
Help Map ID:	6551

Avg/Hold Num

Specifies the number of measurement averages used when calculating the measurement result. The average is displayed at the end of each sweep.

Initiates an averaging routine that averages the sweep points in a number of successive sweeps, resulting in trace smoothing.

After the specified number of average counts, the average mode (termination control) setting determines the average action.

Key Path:	Meas Setup
Mode:	WCDMA, C2K, WIMAX OFDMA, TD-SCDMA, 1xEVDO, LTE, LTETDD, BLUETOOTH, WLAN
Remote Command:	[:SENSe] :OBWidth:AVERage:COUNT <integer> [:SENSe] :OBWidth:AVERage:COUNT? [:SENSe] :OBWidth:AVERage [:STATe] ON OFF 1 0 [:SENSe] :OBWidth:AVERage [:STATe] ?
Example:	OBW:AVER:COUN 1500 OBW:AVER:COUN? OBW:AVER ON OBW:AVER?
Notes:	You must be in the W-CDMA mode, cdma2000 mode, TD-SCDMA mode, BLUETOOTH mode, LTE mode, LTE TDD mode, WLAN mode, 1xEVDO mode, or WIMAX OFDMA mode to use this command. Use:INSTrument:SElect to set the mode.
Couplings:	None Averaging state is coupled to Max Hold. If Max Hold is changed from Off to On, Averaging state is automatically set to On.

Occupied Bandwidth Measurement
Meas Setup

Preset:	10 ON
State Saved:	Saved in instrument state.
Min:	1
Max:	10000
Backwards Compatibility SCPI:	[:SENSe]:EBWidth:AVERage:COUNT
Initial S/W Revision:	Prior to A.02.00
Modified at S/W Revision:	A.03.00
Help Map ID:	6512

Avg Mode

Enables you to set the averaging mode.

- When set to Exponential (Exp) the measurement averaging continues using the specified number of averages to compute each averaged value. The average is displayed at the end of each sweep.
- When set to Repeat, the measurement resets the average counter each time the specified number of averages is reached.

Key Path:	Meas Setup
Mode:	WCDMA, C2K, WIMAX OFDMA, TD-SCDMA, 1xEVDO, LTE, LTETDD, BLUETOOTH, WLAN
Remote Command:	[:SENSe]:OBWidth:AVERage:TCONtrol EXPonential REPeat [:SENSe]:OBWidth:AVERage:TCONtrol?
Example:	OBW:AVER:TCON REP OBW:AVER:TCON?
Notes:	You must be in the W-CDMA mode, cdma2000 mode, TD-SCDMA mode, BLUETOOTH mode, LTE mode, LTE TDD mode, WLAN mode, 1xEVDO mode, or WIMAX OFDMA mode to use this command. Use:INSTrument:SELEct to set the mode.
Preset:	EXP
State Saved:	Saved in instrument state.
Range:	Exp Repeat
Initial S/W Revision:	Prior to A.02.00
Modified at S/W Revision:	A.03.00
Help Map ID:	6513

Max Hold (Remote Command Only)

When On, Max Hold displays and holds the maximum responses of the current measurement. Turn Max Hold to Off to disable the maximum hold feature.

Key Path:	SCPI Only
Mode:	WCDMA, C2K, WIMAX OFDMA, TD-SCDMA, 1xEVDO, LTE, LTETDD, BLUETOOTH, WLAN
Remote Command:	[:SENSe] :OBWidth:MAXHold ON OFF 1 0 [:SENSe] :OBWidth:MAXHold?
Example:	OBW:MAXH ON OBW:MAXH?
Notes:	You must be in the W-CDMA mode, cdma2000 mode, TD-SCDMA mode, BLUETOOTH mode, LTE mode, LTE TDD mode, WLAN mode, 1xEVDO mode, or WIMAX OFDMA mode to use this command. Use:INSTrument:SElect to set the mode.
Couplings:	Max Hold is coupled to Average/Hold state. The Max Hold function is activated only if Average state is On. If Max Hold is changed to On when Average state is Off, Average state is automatically set to On.
Preset:	OFF
State Saved:	Saved in instrument state.
Range:	On Off
Backwards Compatibility SCPI:	[:SENSe] :EBWidth:MAXHold
Initial S/W Revision:	Prior to A.02.00
Modified at S/W Revision:	A.03.00
Help Map ID:	0

Occ BW % Pwr

Assigns the percentage of the total power that is measured within the Occupied Bandwidth for the current measurement. The resulting Occupied Bandwidth limits are displayed by markers placed on the frequencies of the specified percentage.

Key Path:	Meas Setup
Mode:	WCDMA, C2K, WIMAX OFDMA, TD-SCDMA, 1xEVDO, LTE, LTETDD, BLUETOOTH, WLAN
Remote Command:	[:SENSe] :OBWidth:PERCent <real> [:SENSe] :OBWidth:PERCent?

Occupied Bandwidth Measurement
Meas Setup

Example:	OBW:PERC 75 OBW:PERC?
Notes:	You must be in the W-CDMA mode, cdma2000 mode, TD-SCDMA mode, BLUETOOTH mode, LTE mode, LTE TDD mode, WLAN mode, 1xEVDO mode, or WIMAX OFDMA mode to use this command. Use:INSTrument:SElect to set the mode. If Mode is BLUETOOTH, the key will be grayed out.
Preset:	99.00
State Saved:	Saved in instrument state.
Min:	10
Max:	99.99
Initial S/W Revision:	Prior to A.02.00
Modified at S/W Revision:	A.03.00
Help Map ID:	6515

x dB

Sets the x dB value used for the "x dB bandwidth" result that measures the bandwidth between two points on the signal which is x dB down from the highest signal point within the OBW Span.

Key Path:	Meas Setup
Mode:	WCDMA, C2K, WIMAX OFDMA, TD-SCDMA, 1xEVDO, LTE, LTETDD, BLUETOOTH, WLAN
Remote Command:	[[:SENSE]:OBwidth:XDB <rel_ampl> [[:SENSE]:OBwidth:XDB?
Example:	OBW:XDB -20 OBW:XDB?
Notes:	You must be in the W-CDMA mode, cdma2000 mode, TD-SCDMA mode, BLUETOOTH mode, LTE mode, LTE TDD mode, WLAN mode, 1xEVDO mode, or WIMAX OFDMA mode to use this command. Use:INSTrument:SElect to set the mode.
Preset:	-26.0 dB BLUETOOTH: -20.0 dB.
State Saved:	Saved in instrument state.
Min:	-100.0 dB
Max:	-0.1 dB
Backwards Compatibility SCPI:	[[:SENSE]:EBwidth:XDB

Initial S/W Revision:	Prior to A.02.00
Modified at S/W Revision:	A.03.00
Help Map ID:	6516

IF Gain

The **IF Gain** key can be used to set the IF Gain function to Auto, Low Gain or High Gain. These settings affect sensitivity and IF overloads.

This only applies to the RF input. It does not apply to baseband I/Q input.

Key Path:	Meas Setup, IF Gain
Initial S/W Revision:	Prior to A.02.00
Help Map ID:	6552

IF Gain Auto

Activates the Auto Rules for IF Gain. When Auto is active, the IF Gain is set to High Gain under and of the following conditions:

- the input attenuator is set to 0 dB
- the preamp is turned On and the frequency range is under 3.6 GHz

For other settings, Auto sets the IF Gain to Low Gain.

Key Path:	Meas Setup, IF Gain
Mode:	WCDMA, C2K, WIMAX OFDMA, TD-SCDMA, 1xEVDO, LTE, LTETDD, BLUETOOTH, WLAN
Remote Command:	[:SENSE] :OBwidth:IF:GAIN:AUTO [:STATE] ON OFF 1 0 [:SENSE] :OBwidth:IF:GAIN:AUTO [:STATE] ?
Example:	OBW : IF : GAIN : AUTO OFF OBW : IF : GAIN : AUTO ?
Couplings:	When the auto attenuation exists (for example, with electrical attenuator), the IF Gain setting is changed as following rule. Auto sets IF Gain to High Gain under any of the following conditions: the input attenuator is set to 0 dB, or the preamp is turned on and the frequency range is less than 3.6 GHz. For other settings, Auto sets IF Gain to Low Gain.
Preset:	OFF
State Saved:	Saved in instrument state.
Range:	Off On
Initial S/W Revision:	Prior to A.02.00

Occupied Bandwidth Measurement
Meas Setup

Modified at S/W Revision:	A.03.00
Help Map ID:	6517

IF Gain State

Selects the range of the IF Gain.

Key Path:	Meas Setup, IF Gain
Mode:	WCDMA, C2K, WIMAX OFDMA, TD-SCDMA, 1xEVDO, LTE, LTETDD, BLUETOOTH, WLAN
Remote Command:	[:SENSe] :OBWidth:IF:GAIN [:STATe] ON OFF 1 0 [:SENSe] :OBWidth:IF:GAIN [:STATe] ?
Example:	OBW : IF : GAIN ON OBW : IF : GAIN ?
Notes:	Where ON = high gain OFF = low gain
Couplings:	When the auto attenuation exists (for example, with electrical attenuator), the IF Gain setting is changed as following rule. Auto sets IF Gain to High Gain under any of the following conditions: the input attenuator is set to 0 dB, or the preamp is turned on and the frequency range is less than 3.6 GHz. For other settings, Auto sets IF Gain to Low Gain.
Preset:	OFF
State Saved:	Saved in instrument state.
Range:	Low Gain High Gain
Initial S/W Revision:	Prior to A.02.00
Modified at S/W Revision:	A.03.00
Help Map ID:	6518

Limit

Enables you to turn on or off limit checking at the specified frequency. For results that fail the limit test, a red FAIL appears in the measure bar.

Key Path:	Meas Setup
Mode:	WCDMA, C2K, WIMAX OFDMA, TD-SCDMA, 1xEVDO, LTE, LTETDD, BLUETOOTH, WLAN

Remote Command:	:CALCulate:OBWidth:LIMit:FBLimit <freq> :CALCulate:OBWidth:LIMit:FBLimit? :CALCulate:OBWidth:LIMit[:TEST] ON OFF 1 0 :CALCulate:OBWidth:LIMit[:TEST]?
Example:	CALC:OBW:LIM:FBL 50 kHz CALC:OBW:LIM:FBL? CALC:OBW:LIM OFF CALC:OBW:LIM?
Notes:	You must be in the W-CDMA mode, cdma2000 mode, TD-SCDMA mode, LTE mode, LTE TDD mode, BLUETOOTH mode, WLAN mode, 1xEVDO mode or WIMAX OFDMA mode to use this command. Use:INSTrument:SElect to set the mode.
Preset:	C2K: 1.48 MHz WIMAX OFDMA: 10 MHz TD-SCDMA: 1.6 MHz 1xEVDO: 1.48 MHz LTE, LTETDD: 5 MHz BLUETOOTH: 1 MHz WLAN: If Radio Std is 802.11a/g(OFDM/DSSS-OFDM): 20MHz If Radio Std is 802.11b: 25 MHz If Radio Std is 802.11n(20MHz): 20 MHz If Radio Std is 802.11n(40MHz): 40 MHz If Radio Std is 802.11ac(20MHz): 20 MHz If Radio Std is 802.11ac(40MHz): 40 MHz If Radio Std is 802.11ac(80MHz): 80 MHz If Radio Std is 802.11ac(160MHz): 160 MHz WCDMA, WIMAX OFDMA, TD-SCDMA, 1xEVDO, LTE, LTETDD: ON
State Saved:	Saved in instrument state.
Min:	1 kHz
Max:	Depends on instrument maximum frequency.
Initial S/W Revision:	Prior to A.02.00
Modified at S/W Revision:	A.03.00
Help Map ID:	6519

Meas Preset

Restores all measurement parameters to their default values.

Key Path:	Meas Setup
Mode:	WCDMA, C2K, WIMAX OFDMA, TD-SCDMA, 1xEVDO, LTE, LTETDD, BLUETOOTH, WLAN
Remote Command:	:CONFigure:OBWidth
Example:	CONF:OBW
Initial S/W Revision:	Prior to A.02.00
Modified at S/W Revision:	A.03.00
Help Map ID:	6520

Mode

See Mode@2670@i for more information.

Key Path:	Front-panel key
Initial S/W Revision:	Prior to A.02.00
Help Map ID:	0

Mode Setup

See [Mode Setup@\(SA\)4001, \(WCDMA\)4536, \(OFDMA\)20022, \(cdma2000\)26100, \(1xEVDO\)28100, \(TD-SCDMA\)4001, \(CMMB\)40051, \(ISDB-T\)40250, \(LTE\)28881, \(LTE TDD\)4001, \(BLUETOOTH\)35857, \(WLAN\)45501, \(MSR\)45042](#) for more information.

Key Path:	Front-panel key
Initial S/W Revision:	Prior to A.02.00
Help Map ID:	0

Peak Search

Places the selected marker on the trace point with the maximum y-axis value for that marker's trace. Pressing **Peak Search** with the selected marker off causes the selected marker to be set to Normal, then a peak search is immediately performed.

Key Path:	Front panel key
Mode:	WCDMA, C2K, WIMAX OFDMA, TD-SCDMA, 1xEVDO, LTE, LTETDD, BLUETOOTH, WLAN
Remote Command:	:CALCulate:OBWidth:MARKer [1] 2 3 4 5 6 7 8 9 10 11 12 :M AXimum
Example:	CALC:OBW:MARK2:MAX
Initial S/W Revision:	Prior to A.02.00
Modified at S/W Revision:	A.03.00
Help Map ID:	6543

Recall

See [Recall@2637, \(LTE\)28892, \(LTETDD\)40472, \(MSR\)45000](#) for more information.

Key Path:	Front-panel key
Initial S/W Revision:	Prior to A.02.00
Help Map ID:	0

Restart

See Restart@3307@i for more information.

Key Path:	Front-panel key
Initial S/W Revision:	Prior to A.02.00
Help Map ID:	0

Save

See [Save@2600, \(MSR\)45003@i](#) for more information.

Key Path:	Front-panel key
Initial S/W Revision:	Prior to A.02.00
Help Map ID:	0

Data

See [Data@2611@i](#) for more information.

Key Path:	Front-panel key
Help Map ID:	0

Measurement Results

Pressing this key selects Meas Results as the data type to be exported.

The Meas Results file contains measurement result sets, plus information describing the current state of the analyzer, as detailed in [“Meas Results File Definition”](#) on page 435 and [“Meas Results File Example”](#) on page 436 below.

Key Path:	Save, Data
Remote Command:	:MMEMory:STORe:RESults <string>
Example:	:MMEM:STOR:RES “MeasR_0000.csv”
Notes:	<p>If the save is initiated via SCPI and the file already exists, the file will be overwritten.</p> <p>The SCPI command exports Occupied Bandwidth measurement results to the file specified as the parameter in the current path. The default path is My Documents\<current mode>\data\obw\results.<="" p=""> <p>Using the C: drive is strongly discouraged, since it runs the risk of being overwritten during an instrument software upgrade.</p> <p>The SCPI parameter is a quoted string that specifies the filename. Both single and double quotes are supported for any filename parameter over SCPI.</p> </current></p>
Dependencies:	The current active measurement must be the Occupied Bandwidth measurement to use this command.
Status Bits/OPC dependencies:	Sequential – waits for the previous measurement to complete
Initial S/W Revision:	Prior to A.02.00
Help Map ID:	6564

Meas Results File Definition

The content of a Meas Results File is defined in this section.

The first lines in the file consist of identification and instrument configuration details, as follows.

File ID string, which is “MeasResult”

Measurement ID following Mode ID, which is “SA:OBW” for example.

Firmware rev and model number

Option string

Auto Sweep Time Rules

Average Mode

Average Number

Average State

Center Frequency

Detector

IFGain

IFGainAuto

Internal Preamp

Internal Preamp Band

Limit

Limit State

Max Hold

OBW Percent Pwr

Resolution Band Width

Resolution Bandwidth Shape

Span

Sweep Points

Sweep Time

Sweep Time Auto

TriggerSource

Video Bandwidth

x DB

The data above is followed in the file by a line containing “MeasResult1” and “MeasResult2”. This line forms a header for each set of measurement results, which appear in subsequent lines. Each line of Measurement Results consists of two comma-separated values, for MeasResult1 and MeasResult2

respectively.

The MeasResult1 set in the file corresponds to the data returned by MEAS|READ|FETCh:OBWidth1, and the MeasResult2 set corresponds to the data returned by MEAS|READ|FETCh:OBWidth2.

The exported file is in CSV format, with a .csv extension.

Meas Results File Example

When imported into Microsoft Excel, a typical Meas Results CSV file appears as shown in the example below.

MeasResult	
SA:OBW	
A.10.53	N9030A
B25 B40	1
Auto Sweep Time Rules	Normal
Average Mode	Exponential
Average Number	10
Average State	TRUE
Center Frequency	1.33E+10
Detector	Average
IFGain	FALSE
IFGainAuto	FALSE
Internal Preamp	FALSE
Internal Preamp Band	Low
Limit	5000000
Limit State	FALSE
Max Hold	FALSE
OBW Percent Pwr	99
Resolution Band Width	27000
Resolution Bandwidth Shape	Gaussian
Span	3000000
Sweep Points	1001
Sweep Time	0.004933
Sweep Time Auto	TRUE
TriggerSource	Free

Video Bandwidth	270000
x DB	-26
MeasResult1	MeasResult2
2971020.10835045	-94.3702543927405
-74.9741251886604	-94.1447790390963

Single

See Single@3515@i for more information.

Key Path:	Front-panel key
Initial S/W Revision:	Prior to A.02.00
Help Map ID:	0

Source (Internal)

Operation of this key is identical across all measurements. For details about this key, see [Source \(Internal\)@35360@i](#).

Key Path:	Front-panel key
Initial S/W Revision:	Prior to A.02.00
Help Map ID:	0

Span X Scale

Activates the Span function and displays the menu of span functions. The parameter values are measurement independent.

Key Path:	Front-panel key
Initial S/W Revision:	Prior to A.02.00
Help Map ID:	6545

Span

Set the frequency of the occupied bandwidth span for the current measurement.

Key Path:	Span X Scale
Mode:	WCDMA, C2K, WIMAX OFDMA, TD-SCDMA, 1xEVDO, LTE, LTETDD, BLUETOOTH, WLAN
Remote Command:	[:SENSe] :OBWidth:FREQuency:SPAN <freq> [:SENSe] :OBWidth:FREQuency:SPAN?
Example:	OBW:FREQ:SPAN 2.4 MHz OBW:FREQ:SPAN?
Preset:	WCDMA: 10 MHz WIMAX OFDMA: 20 MHz CDMA2K: 2 MHz TD-SCDMA: 4.8 MHz 1xEVDO: 3.75 MHz LTE, LTETDD: 10 MHz BLUETOOTH:2 MHz WLAN: If Radio Std is 802.11a/g 802.11n(20MHz) 802.11ac(20MHz): 25 MHz If Radio Std is 802.11b: 30MHz If Radio Std is 802.11n(40MHz), 802.11ac (40MHz): 50 MHz If Radio Std is 802.11ac(80MHz): 100MHz If Radio Std is 802.11ac(160MHz): 200MHz ON
State Saved:	Saved in instrument state.
Min:	100 Hz

Max:	Hardware Dependent: Option 503 = 3.7 GHz Option 504 = 3.9 GHz
Backwards Compatibility SCPI:	[:SENSe]:EBWidth:FREQuency:SPAN
Initial S/W Revision:	Prior to A.02.00
Modified at S/W Revision:	A.03.00, A.10.00
Help Map ID:	6500

Full Span

Changes the Occupied Bandwidth Span to show the full frequency range of the analyzer. When using external mixing, it changes the displayed frequency span to the frequency range specified for the selected external mixing band.

Key Path:	Span X Scale
Mode:	WCDMA, C2K, WIMAX OFDMA, TD-SCDMA, 1xEVDO, LTE, LTETDD, BLUETOOTH, WLAN
Remote Command:	[:SENSe] :OBWidth:FREQuency:SPAN:FULL
Example:	OBW:FREQ:SPAN:FULL
Notes:	You must be in the W-CDMA mode, cdma2000 mode, TD-SCDMA mode, BLUETOOTH mode, LTE mode, LTE TDD mode, WLAN mode, 1xEVDO mode, or WIMAX OFDMA mode to use this command. Use:INSTrument:SElect to set the mode.
Couplings:	Selecting full span changes the measurement span value.
Initial S/W Revision:	Prior to A.02.00
Modified at S/W Revision:	A.03.00
Help Map ID:	6501

Last Span

Changes the measurement frequency span to previous measurement span setting. If there is no existing previous span value then the span remains unchanged.

Key Path:	Span X Scale
Mode:	WCDMA, C2K, WIMAX OFDMA, TD-SCDMA, 1xEVDO, LTE, LTETDD, BLUETOOTH, WLAN
Remote Command:	[:SENSe] :OBWidth:FREQuency:SPAN:PREVIOUS
Example:	OBW:FREQ:SPAN:PREV

Occupied Bandwidth Measurement
Span X Scale

Notes:	You must be in the W-CDMA mode, cdma2000 mode, TD-SCDMA mode, BLUETOOTH mode, LTE mode, LTE TDD mode, WLAN mode, 1xEVDO mode, or WIMAX OFDMA mode to use this command. Use:INSTrument:SElect to set the mode.
Couplings:	Selecting last span changes the measurement span value.
Initial S/W Revision:	Prior to A.02.00
Modified at S/W Revision:	A.03.00
Help Map ID:	6502

Sweep/Control

Displays a menu of functions that enable you to set up and control the sweep time and source for the current measurement.

For details about this key, see [Sweep/Control@3273](#).

Key Path:	Front-panel key
Initial S/W Revision:	Prior to A.02.00
Help Map ID:	6554

Sweep Time

Selects the length of time in which the spectrum analyzer sweeps the displayed frequency span. Additional overhead time, which impacts the sweep rate, is not calculated as part of the sweep time. In fact:

- sweep rate = span/sweep time
- update rate = 1/(sweep time + overhead)
- sweep cycle time = sweep time + overhead

Sweep time is coupled to RBW and VBW, and is impacted by the number of sweep points, so changing those parameters may change the sweep time.

This function is not available when the selected input is I/Q.

Key Path:	Sweep/Control
Mode:	WCDMA, C2K, WIMAX OFDMA, TD-SCDMA, 1xEVDO, LTE, LTETDD, BLUETOOTH, WLAN
Remote Command:	[:SENSE] :OBWidth:SWEep:TIME <time> [:SENSE] :OBWidth:SWEep:TIME? [:SENSE] :OBWidth:SWEep:TIME:AUTO OFF ON 0 1 [:SENSE] :OBWidth:SWEep:TIME:AUTO?
Example:	OBW:SWE:TIME 50 ms OBW:SWE:TIME? OBW:SWE:TIME:AUTO ON OBW:SWE:TIME:AUTO?
Couplings:	When you manually change the Sweep Time, this state automatically goes to 'Man'.

Occupied Bandwidth Measurement
Sweep/Control

Preset:	WIMAX OFDMA, C2K, TD-SCDMA, 1xEVDO, LTE, LTETDD, BLUETOOTH, WLAN: Automatically Calculated WCDMA: 32.6 ms WIMAX OFDMA, C2K, TD-SCDMA, 1xEVDO, LTE, LTETDD, WLAN: ON WCDMA: OFF
State Saved:	Saved in instrument state.
Min:	1 ms
Max:	4000 s
Initial S/W Revision:	Prior to A.02.00
Modified at S/W Revision:	A.03.00
Help Map ID:	6522

Sweep Setup

Accesses the sweep setup settings for the current measurement.

Key Path:	Sweep/Control
Initial S/W Revision:	Prior to A.02.00
Help Map ID:	6555

Auto Sweep Time Rules

Switches the analyzer between normal and accuracy sweep states.

Setting Auto Sweep Time to Accy results in slower sweep times, usually about three times as long, but better amplitude accuracy for CW signals. The instrument amplitude accuracy specifications only apply when Auto Sweep Time is set to Accy.

Additional amplitude errors which occur when Auto Sweep Time is set to Norm are usually well under 0.1 dB, though this is not guaranteed. Because of the faster sweep times and still low errors, Norm is the preferred setting of Auto Sweep Time. Auto Sweep Time is set to Norm on a Preset or Auto Couple. This means that in the Preset or Auto Coupled state, instrument amplitude accuracy specifications do not apply.

Key Path:	Sweep/Control, Sweep Setup
Mode:	WCDMA, C2K, WIMAX OFDMA, TD-SCDMA, 1xEVDO, LTE, LTETDD, BLUETOOTH, WLAN
Remote Command:	[:SENSE] :OBWidth :SWEep :TIME :AUTO :RULEs NORMal ACCuracy [:SENSE] :OBWidth :SWEep :TIME :AUTO :RULEs ?

Example:	OBW:SWE:TIME:AUTO:RUL NORM OBW:SWE:TIME:AUTO:RUL?
Notes:	Set to Norm when Auto Couple is pressed or sent remotely.
Preset:	NORMal
State Saved:	Saved in instrument state.
Range:	Norm Accy
Initial S/W Revision:	Prior to A.02.00
Modified at S/W Revision:	A.03.00
Help Map ID:	6523

Pause

Pauses the measurement after the current data acquisition is complete.

When Paused, the label on the key changes to **Resume**. Pressing **Resume** resumes the measurement at the point where it had been paused.

See [Pause/Resume@3290](#) for more information.

Key Path:	Sweep/Control
Initial S/W Revision:	Prior to A.02.00
Help Map ID:	6556

Gate

Accesses a menu that enables you to control the gating function.

The Gate functionality is used to view signals best viewed by qualifying them with other events.

This function is not available when the selected input is I/Q.

See [Gate@3292@i](#) for more information.

Key Path:	Sweep/Control
Initial S/W Revision:	Prior to A.02.00
Help Map ID:	Use 3292

Points

Sets the number of points per sweep. The resolution of setting the sweep time depends on the number of points selected. The current value of points is displayed parenthetically, next to the sweep time in the

Occupied Bandwidth Measurement
Sweep/Control

lower-right corner of the display.

Key Path:	Sweep/Control
Mode:	WCDMA, C2K, WIMAX OFDMA, TD-SCDMA, 1xEVDO, LTE, LTETDD, BLUETOOTH, WLAN
Remote Command:	[:SENSE] :OBwidth:SWEEp:POINts <integer> [:SENSE] :OBwidth:SWEEp:POINts?
Example:	OBW:SWE:POIN 1500 OBW:SWE:POIN?
Notes:	This function is not available when signal identification is set to On (external mixing). Affected by: log sweep Grayed out in measurements that don't support swept Blanked in modes that do not support swept. Whenever the number of sweep points change: - All trace data is erased - Any traces with Update Off also go to Display Off (like going from View to Blank in the older analyzers) - Sweep time is re-quantized - Any limit lines that are on are updated - If averaging/hold is on, averaging/hold starts over
Couplings:	Whenever the number of sweep points change, the sweep time is re-quantized.
Preset:	LTE, LTETDD: 2001 Other: 1001
State Saved:	Saved in instrument state.
Min:	101
Max:	20001
Initial S/W Revision:	Prior to A.02.00
Modified at S/W Revision:	A.03.00
Help Map ID:	6532

Trace/Detector

Accesses a menu of functions that enable you to control the detectors for the current measurement.

Key Path:	Front-panel key
Initial S/W Revision:	Prior to A.02.00
Help Map ID:	6549

Trace Type

Allows you to select the type of trace you want to you use for the current measurement.

The first page of this menu contains a 1–of–N selection of the trace type (Clear Write, Average, Max Hold, Min Hold) for the selected trace.

Key Path:	Trace/Detector
Mode:	WCDMA, C2K, WIMAX OFDMA, TD-SCDMA, 1xEVDO, LTE, LTETDD, BLUETOOTH, WLAN
Remote Command:	:TRACe:OBWidth:TYPE WRITe AVERAge MAXHold MINHold :TRACe:OBWidth:TYPE?
Example:	TRAC:OBW:TYPE MINH TRAC:OBW:TYPE?
Notes:	WRITe = Clear Write AVERAge = Average MAXHold = Maximum Hold MINHold = Minimum Hold
Couplings:	When Detector setting is “Auto” (:SENSE]:OBWidth:DETEctor:AUTO?), Detector (:SENSE]:OBWidth:DETEctor[:FUNCTion]?) switches aligning with the switch of this parameter: “NORMal” with WRITe (Clear Write), “AVERAge” with AVERAge, “POSitive (peak)” with MAXHold, and “NEGative (peak)” with MINHold.
Preset:	AVERAge BLUETOOTH: MAX HOLD.
State Saved:	Saved in instrument state.
Range:	WRITe AVERAge MAXHold MINHold
Initial S/W Revision:	Prior to A.02.00
Modified at S/W Revision:	A.03.00
Help Map ID:	6527

Detector

Accesses a menu of functions that enables you to control the detectors for the current measurement. The following choices are available:

- **Auto**- the detector selected depends on marker functions, trace functions, average type, and the trace averaging function.
- **Normal**-the detector determines the peak of the CW-like signals, and it yields alternating maximums and minimums of noise-like signals. This is also referred to as Rosenfell detection.
- **Average**-the detector determines the average of the signal within the sweep points. The averaging method depends upon the Average Type selection (voltage, power or log scales).
- **Peak (Positive)**-the detector determines the maximum of the signal within the sweep points.
- **Sample**-the detector indicates the instantaneous level of the signal at the center of the sweep points represented by each display point.
- **Negative Peak**-the detector determines the minimum of the signal within the sweep points.

Key Path:	Detector
Initial S/W Revision:	Prior to A.02.00
Help Map ID:	6528

Detector Selection

Allows you to select a specific detector for the current measurement. When the detector choice is Auto, the analyzer selects the detector. The selected detector depends on marker functions, trace functions, and trace averaging functions for the current measurement.

Key Path:	Trace/Detector
Mode:	WCDMA, C2K, WIMAX OFDMA, TD-SCDMA, 1xEVDO, LTE, LTETDD, BLUETOOTH, WLAN
Remote Command:	[:SENSe] :OBWidth:DETEctor [:FUNction] NORMal AVERAge POSitive SAMPlE NEGative [:SENSe] :OBWidth:DETEctor [:FUNction] ?
Example:	OBW:DET NORM OBW:DET?

Notes:	<p>When you manually select a detector (instead of selecting Auto), that detector is used regardless of other analyzer settings.</p> <p>The detector choices are:</p> <p>The Normal detector determines the peak of CW-like signals, and it yields alternating maximums and minimums of noise-like signals. This is also referred to as Rosenfell detection.</p> <p>The Average detector determines the average of the signal within the sweep points. The averaging method is Power Average (RMS).</p> <p>The Peak detector determines the maximum of the signal within the sweep points.</p> <p>The Sample detector indicates the instantaneous level of the signal at the center of the sweep points represented by each display point.</p> <p>The Negative Peak detector determines the minimum of the signal within the sweep points.</p>
Couplings:	When Detector setting is “Auto” (:SENSe]:OBWidth:DETEctor:AUTO?), Detector (:SENSe]:OBWidth:DETEctor[:FUNctio]?) switches aligning with the switch of this parameter: “NORMal” with Clear Write, “AVERage” with AVERage, “POSitive (peak)” with MAXHold, and “NEGative (peak)” with MINHold.
Preset:	AVERage BLUETOOTH: Peak
State Saved:	Saved in instrument state.
Range:	Normal Average Peak Sample Negative Peak
Initial S/W Revision:	Prior to A.02.00
Modified at S/W Revision:	A.03.00
Help Map ID:	6507

Auto

When the detector choice is Auto, the analyzer selects the detector. The selected detector depends on marker functions, trace functions, and trace averaging functions for the current measurement.

Key Path:	Trace/Detector
Remote Command:	[:SENSe] :OBWidth:DETEctor:AUTO ON OFF 1 0 [:SENSe] :OBWidth:DETEctor:AUTO?
Example:	OBW:DET:AUTO ON OBW:DET:AUTO?

Occupied Bandwidth Measurement
Trace/Detector

Couplings:	When Detector setting is “Auto” ([:SENSe]:OBWidth:DETECTOR:AUTO?), Detector ([:SENSe]:OBWidth:DETECTOR[:FUNCTION]?) switches aligning with the switch of this parameter: “NORMal” with Clear Write, “AVERage” with AVERage, “POSitive (peak)” with MAXHold, and “NEGative (peak)” with MINHold.
Preset:	ON
State Saved:	Saved in instrument state.
Initial S/W Revision:	Prior to A.02.00
Modified at S/W Revision:	A.03.00
Help Map ID:	6508

Trigger

See [Trigger@3371](#) for information about all keys in this menu.

Key Path:	Front-panel key
Initial S/W Revision:	Prior to A.02.00
Help Map ID:	0

View/Display

Accesses a menu of functions that enable you to set the view and display parameters for the current measurement.

There is a single results view available for this measurement. For more details, and samples of screen content for each supported mode, see [“Spectrum View” on page 452](#) below.

The following result descriptions are available:

Occupied Bandwidth

The occupied bandwidth result is $f_2 - f_1$, where f_1 and f_2 are calculated.

Total Power

The total power is the power integrated in the specified span setting.

Transmit Freq Error

The transmit freq error (transmit frequency error) result is calculated as the difference between $(f_2+f_1)/2$ and the tuned center frequency of the signal, where f_1 and f_2 are calculated.

x dB Bandwidth

The x dB result is a bandwidth measured between two points on the signal which are a certain number of dBs down from the highest signal point within the OBW Span. For example, If the ‘x dB’ parameter is set to -26 dB, and the ‘Occupied BW Span’ is set to 10 MHz, then the maximum signal power level is first determined from the 10 MHz wide trace sweep. Next, the two furthest frequencies below ($x_{db_f_1}$) and above ($x_{db_f_2}$) the frequency of the maximum level occurrence are found where the signal level is 26 dB below the peak level. This calculation also uses linear interpolation to find the lower and upper carrier boundary point within the width of a sweep point (the span divided by the number of sweep points).

The x dB bandwidth is calculated to be $x_{db_f_2} - x_{db_f_1}$.

Spectrum View

NOTE	An asterisk next to the x dB bandwidth value indicates the results may not have been determined with optimal analyzer settings. If this result (emission bandwidth) is your primary interest, select Meas Setup, Max Hold, On. Then, change the detector mode to Peak. Acquiring peak data ensures accuracy of the result.
-------------	--

For WCDMA, C2K, 1xEVDO, WIMAX OFDMA, WLAN modes:

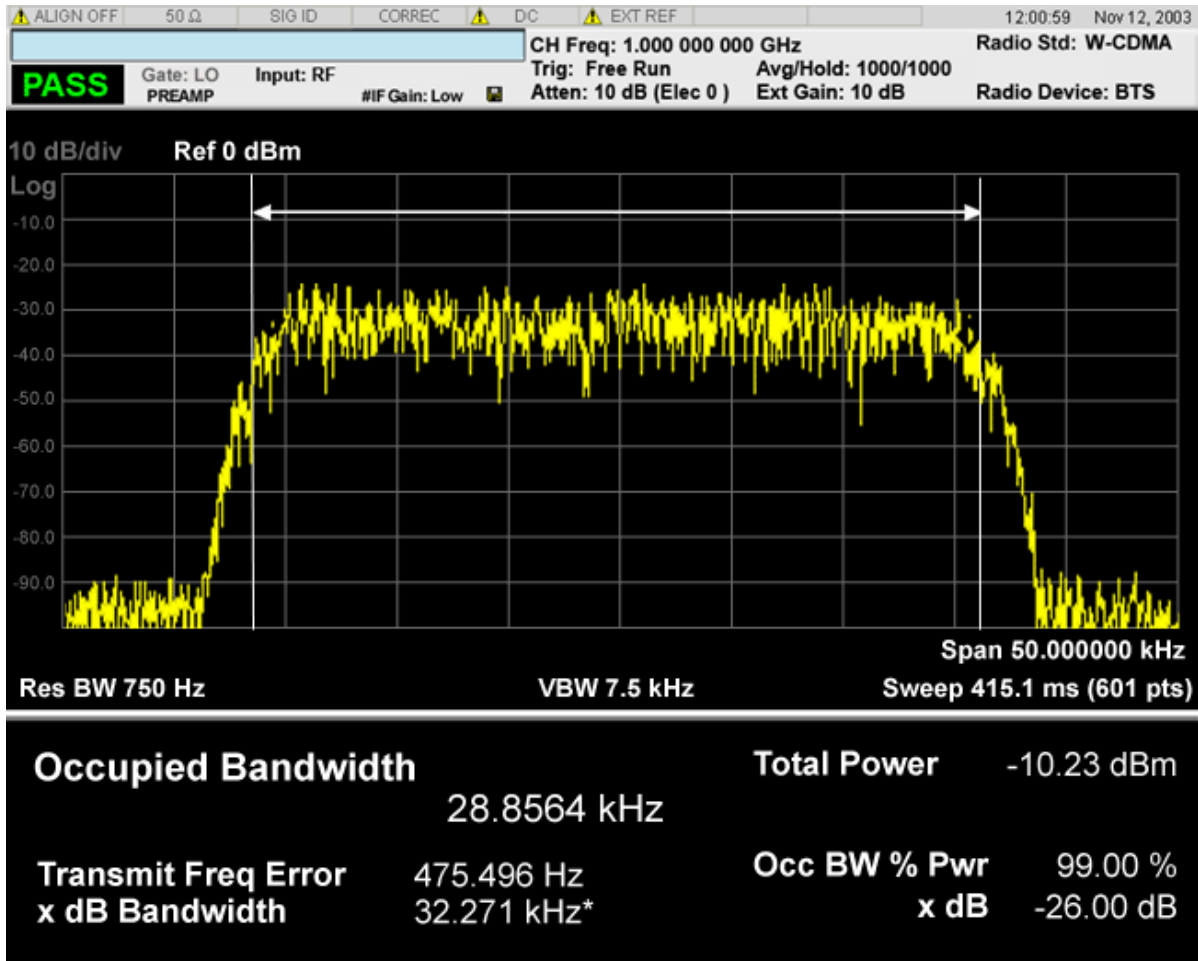

For TD-SCDMA mode only:

Occupied Bandwidth Measurement
View/Display

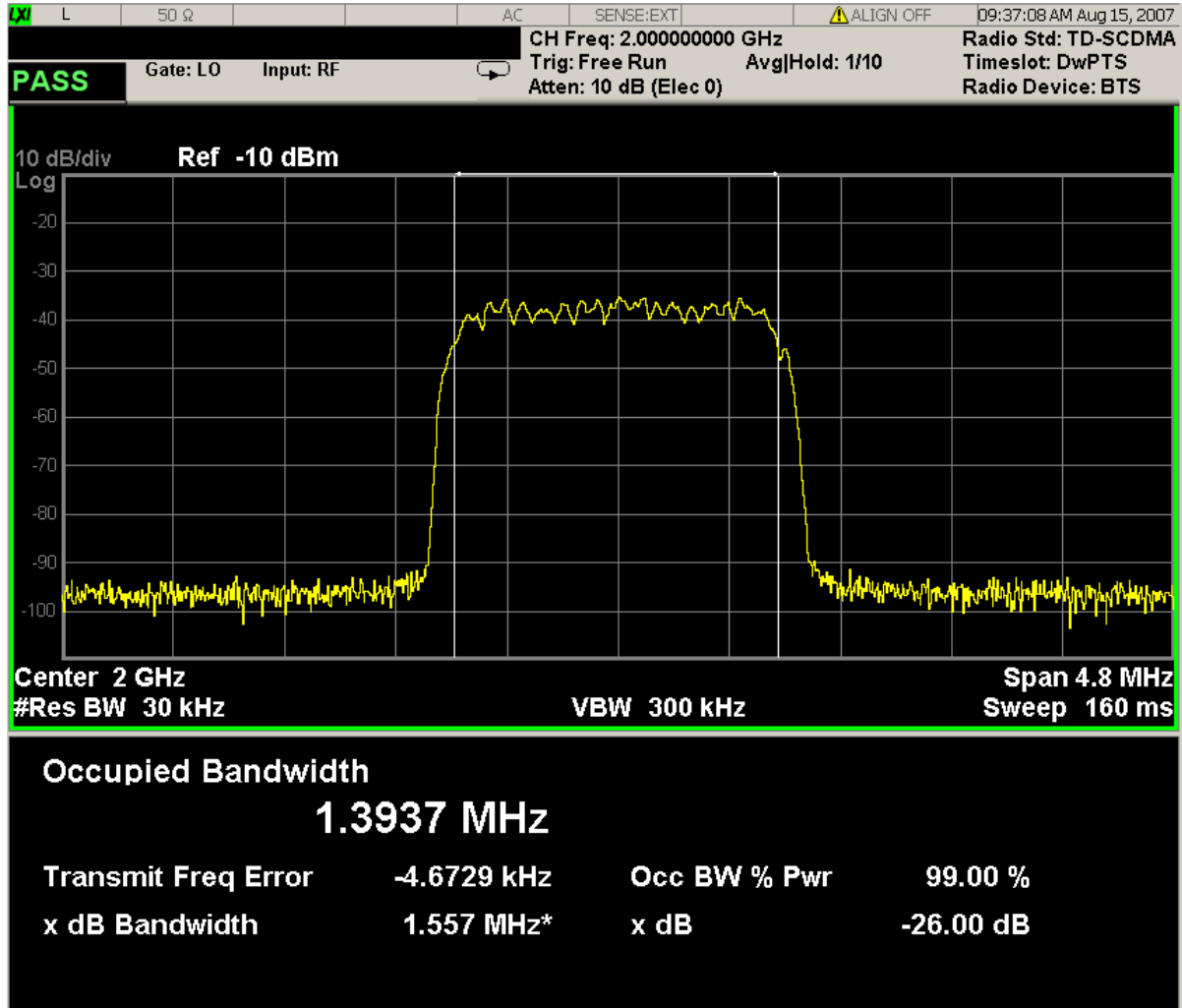

For Bluetooth mode only:

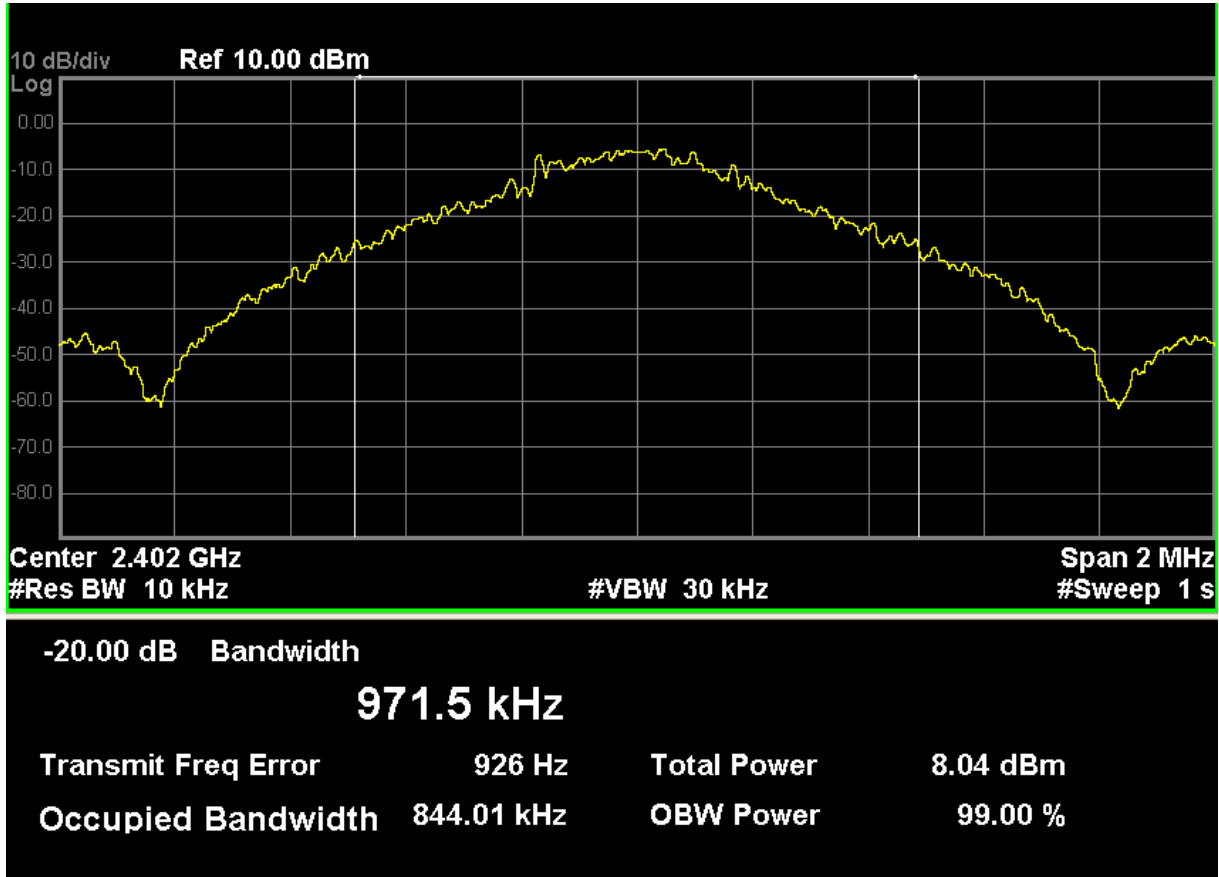

The number of active carriers is displayed. Since span is determined from detected carriers in auto mode, it is necessary to show how many carriers are identified as active., as highlighted above.

When there is one active carrier, Transmit Freq Error is displayed. Otherwise, “---“ is displayed, as shown above.

Key Path:	Front-panel key
Initial S/W Revision:	Prior to A.02.00
Help Map ID:	6547

Display

Accesses a menu of functions that enable you to set the display parameters.

See [Display@3440](#) for more information.

Key Path:	View/Display
Initial S/W Revision:	Prior to A.02.00

Occupied Bandwidth Measurement
View/Display

Help Map ID:	0
--------------	---

8 ACP Measurement

ACP is a measurement of the amount of interference, or power, in an adjacent frequency channel. The results are displayed as a bar graph or as spectrum data, with measurement data at specified offsets. For measurement results and views, see [“View/Display” on page 549](#).

This topic contains the following sections:

[“Measurement Commands for ACP” on page 457](#)

[“Remote Command Results for ACP Measurement” on page 457](#)

Measurement Commands for ACP

The following commands are used to retrieve the measurement results:

:CONFigure:ACP

:CONFigure:ACP:NDEFault

:INITiate:ACP

:FETCh:ACP [n] ?

:READ:ACP [n] ?

:MEASure:ACP [n] ?

For more measurement related commands, see the SENSE subsystem, and the section [Remote Measurement Functions@29978](#).

Remote Command Results for ACP Measurement

Condition	N	Results Returned
-----------	---	------------------

<p>Meas Type = Total power reference</p>	<p>Not specified or n = 1</p>	<p>Returns 28 comma-separated scalar results, in the following order.</p> <ol style="list-style-type: none"> 1. 0.0 2. Total carrier power (dBm) 3. 0.0 4. Reference carrier power (dBm) 5. Lower offset A - relative power (dB) 6. Lower offset A - absolute power (dBm) 7. Upper offset A - relative power (dB) 8. Upper offset A - absolute power (dBm) 9. Lower offset B - relative power (dB) 10. Lower offset B - absolute power (dBm) 11. Upper offset B - relative power (dB) 12. Upper offset B - absolute power (dBm) ... 25. Lower offset F - relative power (dB) 26. Lower offset F - absolute power (dBm) 27. Upper offset F - relative power (dB) 28. Upper offset F - absolute power (dBm) <p>If the results are not available, -999.0 is returned.</p>
--	-----------------------------------	---

Meas Type = Power spectral density reference	not specified or n = 1	<p>Returns 28 comma-separated scalar results, in the following order.</p> <ol style="list-style-type: none"> 1. 0.0 2. Total carrier power (dBm/Hz or dBm/MHz) 3. 0.0 4. Reference carrier power (dBm/Hz or dBm/MHz) 5. Lower offset A - relative power (dB) 6. Lower offset A - absolute power (dBm/Hz or dBm/MHz) 7. Upper offset A - relative power (dB) 8. Upper offset A - absolute power (dBm/Hz or dBm/MHz) 9. Lower offset B - relative power (dB) 10. Lower offset B - absolute power (dBm/Hz or dBm/MHz) 11. Upper offset B - relative power (dB) 12. Upper offset B - absolute power (dBm/Hz or dBm/MHz) ... 25. Lower offset F - relative power (dB) 26. Lower offset F - absolute power (dBm/Hz or dBm/MHz) 27. Upper offset F - relative power (dB) 28. Upper offset F - absolute power (dBm/Hz or dBm/MHz) <p>If the results are not available, -999.0 is returned.</p>
Meas Method = FAST	not specified or n = 1	<p>Returns 5 comma-separated results, in the following order:</p> <ol style="list-style-type: none"> 1. Reference carrier - absolute power (dBm) 2. Lower offset A - absolute power (dBm) 3. Upper offset A - absolute power (dBm) 4. Lower offset B - absolute power (dBm) 5. Upper offset B - absolute power (dBm)

<p>Meas Type = Total power reference</p>	<p>n = 2</p>	<p>Returns 48 scalar results, in the following order:</p> <ol style="list-style-type: none"> 1. Channel (1) - relative power (dB) 2. Channel (1) - absolute power (dBm) 3. Channel (2) - relative power (dB) 4. Channel (2) - absolute power (dBm) ... 23. Channel (12) - relative power (dB) 24. Channel (12) - absolute power (dBm) 25. Lower offset A - relative power (dB) 26. Lower offset A - absolute power (dBm) 27. Upper offset A - relative power (dB) 28. Upper offset A - absolute power (dBm) 29. Lower offset B - relative power (dB) 30. Lower offset B - absolute power (dBm) 31. Upper offset B - relative power (dB) 32. Upper offset B - absolute power (dBm) ... 45. Lower offset F - relative power (dB) 46. Lower offset F - absolute power (dBm) 47. Upper offset F - relative power (dB) 48. Upper offset F - absolute power (dBm) <p>If the results are not available, -999.0 is returned.</p>
--	--------------	--

<p>Meas Type = Power spectral density reference</p>	<p>n = 2</p>	<p>Returns 48 scalar results, in the following order:</p> <ol style="list-style-type: none"> 1. Channel (1) - relative power (dB) 2. Channel (1) - absolute power (dBm/Hz or dBm/MHz) 3. Channel (2) - relative power (dB) 4. Channel (2) - absolute power (dBm/Hz or dBm/MHz) ... 23. Channel (12) - relative power (dB) 24. Channel (12) - absolute power (dBm/Hz or dBm/MHz) 25. Lower offset A - relative power (dB) 26. Lower offset A - absolute power (dBm/Hz or dBm/MHz) 27. Upper offset A - relative power (dB) 28. Upper offset A - absolute power (dBm/Hz or dBm/MHz) 29. Lower offset B - relative power (dB) 30. Lower offset B - absolute power (dBm/Hz or dBm/MHz) 31. Upper offset B - relative power (dB) 32. Upper offset B - absolute power (dBm/Hz or dBm/MHz) ... 45. Lower offset F - relative power (dB) 46. Lower offset F - absolute power (dBm/Hz or dBm/MHz) 47. Upper offset F - relative power (dB) 48. Upper offset F - absolute power (dBm/Hz or dBm/MHz) <p>If the results are not available, -999.0 is returned.</p>
---	--------------	--

<p>Meas Type = Total power reference</p>	<p>n = 3</p>	<p>Returns 24 scalar values of the pass/fail (0 = passed, or 1 = failed) determined by testing the relative to the reference carrier and by testing the absolute power limit of the offset frequencies (measured as total power in dB):</p> <ol style="list-style-type: none"> 1. Lower offset A - relative limit result 2. Lower offset A - absolute limit result 3. Upper offset A - relative limit result 4. Upper offset A - absolute limit result 5. Lower offset B - relative limit result 6. Lower offset B - absolute limit result 7. Upper offset B - relative limit result 8. Upper offset B - absolute limit result ... 21 Lower offset F - relative limit result 22 Lower offset F - absolute limit result 23 Upper offset F - relative limit result 24 Upper offset F - absolute limit result
<p>Meas Type = Power spectral density reference</p>	<p>n = 3</p>	<p>Returns 24 scalar values of the pass/fail (0 = passed, or 1 = failed) determined by testing the relative to the reference carrier and by testing the absolute power limit of the offset frequencies (measured as power spectral density in dB):</p> <ol style="list-style-type: none"> 1. Lower offset A - relative limit result 2. Lower offset A - absolute limit result 3. Upper offset A - relative limit result 4. Upper offset A - absolute limit result 5. Lower offset B - relative limit result 6. Lower offset B - absolute limit result 7. Upper offset B - relative limit result 8. Upper offset B - absolute limit result ... 21 Lower offset F - relative limit result 22 Lower offset F - absolute limit result 23 Upper offset F - relative limit result 24 Upper offset F - absolute limit result
	<p>n = 4</p>	<p>Returns <Num Pts> comma-separated scalar values representing the Y values in Trace 1</p>
	<p>n = 5</p>	<p>Returns <Num Pts> comma-separated scalar values representing the Y values in Trace 2</p>

	n = 6	Returns <Num Pts> comma-separated scalar values representing the Y values in Trace 3
Meas Type = Total power reference	n = 7	<p>Returns (2 * numberOfCarriers) scalar results, in the following order:</p> <p>The numberOfCarriers is the value filled in Carriers under Carrier Setup menu. If license N9060A-5FP is enabled, max value of numberOfCarriers is 18, otherwise, max value of numberOfCarriers is 12.</p> <ol style="list-style-type: none"> 1. Channel (1) - relative power (dB) 2. Channel (1) - absolute power (dBm) 3. Channel (2) - relative power (dB) 4. Channel (2) - absolute power (dBm) ... 2 * numberOfCarriers - 1. Channel (numberOfCarriers) - relative power (dB) 2 * numberOfCarriers. Channel (numberOfCarriers) - absolute power (dBm) <p>If the results are not available, 9.91E+37 is returned.</p>
Meas Type = Power spectral density reference	n = 7	<p>Returns (2 * numberOfCarriers) scalar results, in the following order:</p> <p>The numberOfCarriers is the value filled in Carriers under Carrier Setup menu.</p> <p>If license N9060A-5FP is enabled, max value of numberOfCarriers is 18, otherwise, max value of numberOfCarriers is 12.</p> <ol style="list-style-type: none"> 1. Channel (1) - relative power (dB) 2. Channel (1) - absolute power (dBm/Hz or dBm/MHz) 3. Channel (2) - relative power (dB) 4. Channel (2) - absolute power (dBm/Hz or dBm/MHz) ... 2 * numberOfCarriers - 1. Channel (numberOfCarriers) - relative power (dB) 2 * numberOfCarriers. Channel (numberOfCarriers) - absolute power (dBm/Hz or dBm/MHz) <p>If the results are not available, 9.91E+37 is returned</p>

Key Path	Front-panel key
Initial S/W Revision	Prior to A.02.00
Help Map ID	7075

AMPTD Y Scale

Accesses a menu of functions that enable you to set the vertical scale parameters. The parameter values are measurement independent, except all Attenuation values and the Internal Preamp selections, which are the same across all measurements.

Key Path	Front-panel key
Initial S/W Revision	Prior to A.02.00
Help Map ID	7077

Ref Value

Sets the value for the absolute power reference. However, since the Auto Scaling is defaulted to On, this value is automatically determined by the measurement result. When you set a value manually, Auto Scaling automatically changes to Off.

Key Path	AMPTD Y Scale
Mode	WCDMA, C2K, WIMAX OFDMA, TD-SCDMA, 1xEVDO, LTE, LTETDD
Remote Command	:DISPlay:ACPpower:VIEW[1]:WINDow[1]:TRACe:Y[:SCALE]:RLEV el <real> :DISPlay:ACPpower:VIEW[1]:WINDow[1]:TRACe:Y[:SCALE]:RLEV el?
Example	DISP:ACP:VIEW:WIND:TRAC:Y:RLEV 100 DISP:ACP:VIEW:WIND:TRAC:Y:RLEV?
Notes	You must be in the mode that includes ACP measurements to use this command. Use :INSTrument:SElect to set the mode.
Couplings	When the Auto Scaling is On, this value is automatically determined by the measurement result. When you set a value manually, Auto Scaling automatically changes to Off.
Preset	-30 dBm
State Saved	Saved in instrument state.
Min	-250.00 dBm
Max	250.00 dBm
Initial S/W Revision	Prior to A.02.00
Modified at S/W Revision	A.02.00, A.03.00
Help Map ID	7003

Attenuation

Accesses a menu of functions that enable you to change attenuation settings. This key has read-back text that describes the total attenuator value.

See AMPTD Y Scale, [Attenuation@3003](#) in the section for more information.

Key Path	AMPTD Y Scale
Initial S/W Revision	Prior to A.02.00
Help Map ID	7078

Scale/Div

Sets the units-per-division of the vertical scale in the logarithmic display. However, since the Auto Scaling is defaulted to On, this value is automatically determined by the measurement result. When you set a value manually, Auto Scaling automatically changes to Off.

Key Path	AMPTD Y Scale
Mode	WCDMA, C2K, WIMAX OFDMA, TD-SCDMA, 1xEVDO, LTE, LTETDD
Remote Command	:DISPlay:ACPower:VIEW[1]:WINDow[1]:TRACe:Y[:SCALe]:PDIVision <rel_ampl> :DISPlay:ACPower:VIEW[1]:WINDow[1]:TRACe:Y[:SCALe]:PDIVision?
Example	DISP:ACP:VIEW:WIND:TRAC:Y:PDIV 5 DISP:ACP:VIEW:WIND:TRAC:Y:PDIV?
Notes	You must be in the mode that includes ACP measurements to use this command. Use :INSTrument:SElect to set the mode.
Couplings	When the Auto Scaling is On, this value is automatically determined by the measurement result. When you set a value manually, Auto Scaling automatically changes to Off.
Preset	10.00 dB
State Saved	Saved in instrument state.
Min	0.10 dB
Max	20.00 dB
Initial S/W Revision	Prior to A.02.00
Modified at S/W Revision	A.02.00, A.03.00
Help Map ID	7004

Y Axis Unit

Allows you to change the vertical (Y) axis amplitude unit.

See [Y Axis Unit@3021@i](#) under AMPTD Y Scale for more information.

Parameter Name	Y Axis Unit
Key Path	AMPTD/Y Scale
Initial S/W Revision	A.04.00
Help Map ID	0

Internal Preamp

Accesses a menu of functions that enable you to control the internal preamplifiers.

See AMPTD Y Scale, [Internal Preamp@3036@i](#) for more information.

Key Path	AMPTD Y Scale
Initial S/W Revision	Prior to A.02.00
Help Map ID	7082

Ref Position

Positions the reference level at the top, center, or bottom of the Y- scale display. Changing the reference position does not change the reference level value.

Key Path	AMPTD Y Scale
Mode	WCDMA, C2K, WIMAX OFDMA, TD-SCDMA, 1xEVDO, LTE, LTETDD
Remote Command	:DISPlay:ACPpower:VIEW[1]:WINDow[1]:TRACe:Y[:SCALE]:RPOS ition TOP CENTer BOTTom :DISPlay:ACPpower:VIEW[1]:WINDow[1]:TRACe:Y[:SCALE]:RPOS ition?
Example	DISP:ACP:VIEW:WIND:TRAC:Y:RPOS CENT DISP:ACP:VIEW:WIND:TRAC:Y:RPOS?
Notes	You must be in the mode that includes ACP measurements to use this command. Use :INSTrument:SElect to set the mode.
Preset	TOP
State Saved	Saved in instrument state.
Range	Top Ctr Bot
Initial S/W Revision	Prior to A.02.00
Modified at S/W Revision	A.02.00, A.03.00

Help Map ID	7005
-------------	------

Auto Scaling

Toggles the Auto Scaling function between On and Off.

Key Path	AMPTD Y Scale
Mode	WCDMA, C2K, WIMAX OFDMA, TD-SCDMA, 1xEVDO, LTE, LTETDD
Remote Command	:DISPlay:ACPower:VIEW[1]:WINDow[1]:TRACe:Y[:SCALe]:COUP le 0 1 OFF ON :DISPlay:ACPower:VIEW[1]:WINDow[1]:TRACe:Y[:SCALe]:COUP le?
Example	DISP:ACP:VIEW:WIND:TRAC:Y:COUP ON DISP:ACP:VIEW:WIND:TRAC:Y:COUP?
Notes	You must be in the mode that includes ACP measurements to use this command. Use :INSTrument:SElect to set the mode.
Couplings	When Auto Scaling is On and the Restart front-panel key is pressed, this function automatically determines the scale per division and reference values based on the measurement results. When you set a value to either Scale/Div or Ref Value manually, Auto Scaling automatically changes to Off.
Preset	ON
State Saved	Saved in instrument state.
Range	On Off
Initial S/W Revision	Prior to A.02.00
Modified at S/W Revision	A.02.00, A.03.00
Help Map ID	7006

Auto Couple

See AUTO_COUPLE@3041@i for more information.

Key Path	Front-panel key
Initial S/W Revision	Prior to A.02.00
Help Map ID	0

BW

Accesses a menu of functions that enable you to specify and control the video and resolution bandwidths. You can also select the type of filter for the measurement and set the filter bandwidth.

Key Path	Front-panel key
Initial S/W Revision	Prior to A.02.00
Help Map ID	7099

Res BW

Sets the value of the resolution bandwidth. If an unavailable bandwidth is entered with the numeric keypad, the closest available bandwidth is selected.

Key Path	BW
Mode	WCDMA, C2K, WIMAX OFDMA, TD-SCDMA, 1xEVDO, LTE, LTETDD
Remote Command	[:SENSe]:ACPower:BANDwidth[:RESolution] <bandwidth> [:SENSe]:ACPower:BANDwidth[:RESolution]? [:SENSe]:ACPower:BANDwidth[:RESolution]:AUTO ON OFF 1 0 [:SENSe]:ACPower:BANDwidth[:RESolution]:AUTO?
Example	ACP:BAND 25kHz ACP:BAND? ACP:BAND:AUTO ON ACP:BAND:AUTO?
Notes	This key is available only in IBW mode. This parameter is preset by the Meas Method selection. Preset values are as follows: IBW: 100 kHz IBWR: 27 kHz FAST (WCDMA): 390 kHz You must be in the mode that includes ACP measurements to use this command. Use :INSTrument:SElect to set the mode.
Couplings	The resolution bandwidth is coupled to the video bandwidth based on the video to resolution bandwidth ratio setting if AUTO is selected.

ACP Measurement
BW

Preset	WCDMA: 100 kHz WIMAX OFDMA: 100 kHz C2K: Method RBW: grayed out(1.2 MHz) Method IBW: 15 kHz TD-SCDMA: 30 kHz 1xEVDO: 30 kHz LTE: 100 kHz LTETDD: 100 kHz 0
State Saved	Saved in instrument state.
Min	1 Hz
Max	8 MHz
Initial S/W Revision	Prior to A.02.00
Modified at S/W Revision	A.02.00, A.03.00
Help Map ID	7010

Video BW

Changes the test set post-detection filter (VBW).

Key Path	BW
Mode	WCDMA, C2K, WIMAX OFDMA, TD-SCDMA, 1xEVDO, LTE, LTETDD
Remote Command	[:SENSe] :ACPpower :BANDwidth :VIDeo <freq> [:SENSe] :ACPpower :BANDwidth :VIDeo? [:SENSe] :ACPpower :BANDwidth :VIDeo :AUTO OFF ON 0 1 [:SENSe] :ACPpower :BANDwidth :VIDeo :AUTO?
Example	ACP:BAND:VID 1kHz ACP:BAND:VID? ACP:BWID:VID:AUTO ON ACP:BWID:VID:AUTO?
Notes	The values shown in this table reflect the conditions after a Mode Preset.

Preset	WCDMA, WIMAX OFDMA: 1 MHz C2K: Method RBW: grayed out(1.2 MHz) Method IBW: 150 kHz TD-SCDMA: 300 kHz 1xEVDO: 300 kHz LTE: 1 MHz LTETDD: 1 MHz SA: ON WCDMA: OFF WIMAX OFDMA: OFF TD-SCDMA: OFF CDMA 1xEVDO: OFF LTE: ON LTETDD: ON
State Saved	Saved in instrument state.
Min	1 Hz
Max	50 MHz
Backwards Compatibility SCPI	[:SENSe]:ACPower:BWIDth:VIDeo
Initial S/W Revision	Prior to A.02.00
Modified at S/W Revision	A.02.00, A.03.00
Help Map ID	7011

RBW Control

Accesses a menu that enables you to select the filter bandwidth and type.

Key Path	BW
Initial S/W Revision	Prior to A.02.00
Help Map ID	7083

Filter Type

Selects the type of bandwidth filter that is used. The choices are Gaussian or Flat top.

Key Path	BW, RBW Control
Mode	WCDMA, C2K, WIMAX OFDMA, TD-SCDMA, 1xEVDO, LTE, LTETDD

ACP Measurement
BW

Remote Command	[:SENSe] :ACPower :BANDwidth :SHAPE GAUSSian FLATtop [:SENSe] :ACPower :BANDwidth :SHAPE?
Example	ACP:BAND:SHAP GAUS ACP:BAND:SHAP?
Preset	GAUSSian C2K: FLATtop
State Saved	Saved in instrument state.
Range	Gaussian (Normal) Flattop
Backwards Compatibility SCPI	[:SENSe] :ACPower :BWIDth :SHAPE
Initial S/W Revision	Prior to A.02.00
Modified at S/W Revision	A.02.00, A.03.00
Help Map ID	7012

Filter BW

Selects a Gaussian filter based on its –3 dB (Normal) bandwidth or its –6 dB bandwidth.

Key Path	BW, RBW Control
Mode	WCDMA, C2K, WIMAX OFDMA, TD-SCDMA, 1xEVDO, LTE, LTETDD
Remote Command	[:SENSe] :ACPower :BANDwidth :TYPE DB3 DB6 [:SENSe] :ACPower :BANDwidth :TYPE?
Example	ACP:BAND:TYPE DB3 ACP:BAND:TYPE?
Dependencies	When Filter Type is Flattop or Meas Method is RBW or FAST, this key is grayed out and disabled. If the key is pressed, an advisory message is generated. If the equivalent remote command is sent, a "Setting conflict" warning is generated.
Preset	DB3
State Saved	Saved in instrument state.
Range	–3 dB (Normal) –6 dB
Backwards Compatibility SCPI	[:SENSe] :ACPower :BWIDth :TYPE
Initial S/W Revision	Prior to A.02.00
Modified at S/W Revision	A.02.00, A.03.00
Help Map ID	7013

Cont

See [Cont \(Continuous Measurement/Sweep\)@3309@i](mailto:Cont (Continuous Measurement/Sweep)@3309@i) for more information.

Key Path	Front-panel key
Initial S/W Revision	Prior to A.02.00
Help Map ID	0

FREQ Channel

See [FREQ Channel@\(SA, LTE, LTE TDD, TD-SCDMA, 1xEVDO\)3057, \(WCDMA\)3057, \(OFDMA\)20038, \(cdma2000\)26103](#) for more information.

Key Path	Front-panel key
Initial S/W Revision	Prior to A.02.00
Help Map ID	0

Input/Output

See [Key and Command Descriptions@3065@i](mailto:Key_and_Command_Descriptions@3065@i) for more information.

Key Path	Front-panel key
Initial S/W Revision	Prior to A.02.00
Help Map ID	0

Marker

Accesses a menu that enables you to select, set up and control the markers for the current measurement. Note that this key and all sub keys are unavailable when “Meas Method” on page 517 is set to RBW

Key Path	Front-panel key
Initial S/W Revision	Prior to A.02.00
Help Map ID	7095

Select Marker

Displays 12 markers available for selection. Note that this key and all sub keys are unavailable when “Meas Method” on page 517 is set to RBW

Key Path	Marker
Initial S/W Revision	Prior to A.02.00
Help Map ID	7102

Marker Type

Sets the marker control mode to **Normal**, **Delta**, **Fixed** or **Off**. All interactions and dependencies detailed under the key description are enforced when the remote command is sent. If the selected marker is **Off**, pressing **Marker** sets it to **Normal** and places it at the center of the screen on the trace determined by the **Marker Trace** rules. At the same time, **Marker X Axis Value** appears on the Active Function area.

The default active function is the active function for the currently selected marker control mode. If the current control mode is **Off**, there is no active function and the active function is turned off.

Key Path	Marker
Mode	WCDMA, C2K, WIMAX OFDMA, TD-SCDMA, 1xEVDO, LTE, LTETDD
Remote Command	:CALCulate:ACPower:MARKer [1] 2 3 4 5 6 7 8 9 10 11 12 :M ODE POSition DELTA OFF :CALCulate:ACPower:MARKer [1] 2 3 4 5 6 7 8 9 10 11 12 :M ODE?
Example	CALC:ACP:MARK2:MODE DELT CALC:ACP:MARK2:MODE?

Notes	<p>If the selected marker is Off, pressing Marker sets it to Normal and places it at the center of the screen on the trace determined by the Marker Trace rules. At the same time, Marker X Axis Value appears on the Active Function area.</p> <p>Default Active Function: the active function for the selected marker's current control mode. If the current control mode is Off, there is no active function and the active function is turned off.</p> <p>Active Function Display: the marker X axis value entered in the active function area will display the marker value to its full entered precision.</p> <p>You must be in the mode that includes ACP measurements to use this command. Use :INSTrument:SElect to set the mode.</p>
Preset	OFF OFF OFF OFF OFF OFF OFF OFF OFF OFF OFF OFF
State Saved	Saved in instrument state.
Range	Normal Delta Off
Initial S/W Revision	Prior to A.02.00
Modified at S/W Revision	A.02.00, A.03.00
Help Map ID	7058

Marker X Axis Value (Remote Command Only)

Sets the marker X axis value in the current marker X Axis Scale unit. This value has no effect if the control mode is **Off**, but is the SCPI equivalent of entering an X value if the control mode is **Normal**, **Delta** or **Fixed**.

Mode	WCDMA, C2K, WIMAX OFDMA, TD-SCDMA, 1xEVDO, LTE, LTE-TDD
Remote Command	:CALCulate:ACPower:MARKer [1] 2 3 4 5 6 7 8 9 10 11 12 :X <freq> :CALCulate:ACPower:MARKer [1] 2 3 4 5 6 7 8 9 10 11 12 :X ?
Example	CALC:ACP:MARK3:X 0 CALC:ACP:MARK3:X?
Notes	The query returns the marker's absolute X Axis value if the control mode is Normal , or the offset from the marker's reference marker if the control mode is Delta . If the marker is Off the response is not a number.
Dependencies	Unavailable when " Meas Method " on page 517 is set to RBW.
Preset	After a preset, all Markers are turned OFF, so Marker X Axis Value query will return a not a number (NAN).
State Saved	No
Min	-9.9E+37
Max	9.9E+37

Initial S/W Revision	Prior to A.02.00
Modified at S/W Revision	A.02.00, A.03.00
Help Map ID	7059

Marker X Axis Position (Remote Command Only)

Sets the marker X position in trace points. It has no effect if the control mode is **Off**, but is the SCPI equivalent of entering a value if the control mode is **Normal**, **Delta** or **Fixed**. The entered value is immediately translated into the current X Axis Scale units for setting the value of the marker.

Mode	WCDMA, C2K, WIMAX OFDMA, TD-SCDMA, 1xEVDO, LTE, LTETDD
Remote Command	:CALCulate:ACPower:MARKer [1] 2 3 4 5 6 7 8 9 10 11 12 :X :POSition <real> :CALCulate:ACPower:MARKer [1] 2 3 4 5 6 7 8 9 10 11 12 :X :POSition?
Example	CALC:ACP:MARK10:X:POS 0 CALC:ACP:MARK10:X:POS?
Notes	The query returns the marker's absolute X Axis value in trace points if the control mode is Normal , or the offset from the marker's reference marker in trace points if the control mode is Delta . The value is returned as a real number, not an integer, corresponding to the translation from X Axis Scale units to trace points (see "Fractional Trace Points"). If the marker is Off the response is not a number. When a Marker is turned on, it is placed center of the screen on the trace. Therefore the default value depends on instrument condition, although the Preset/Default is defined as 500 (this value might be expected value when all offset is on).
Dependencies	Unavailable when " Meas Method " on page 517 is set to RBW.
Preset	After a preset, all Markers are turned OFF, so Marker X Axis Value query will return a not a number (NAN).
State Saved	No
Min	-9.9E+37
Max	9.9E+37
Initial S/W Revision	Prior to A.02.00
Modified at S/W Revision	A.02.00, A.03.00
Help Map ID	7060

Marker Y Axis Value (Remote Command Only)

Returns the marker Y axis value in the current marker Y axis unit.

Mode	WCDMA, C2K, WIMAX OFDMA, TD-SCDMA, 1xEVDO, LTE, LTETDD
Remote Command	:CALCulate:ACPower:MARKer[1] 2 3 4 5 6 7 8 9 10 11 12:Y?
Example	CALC:ACP:MARK11:Y?
Notes	Since the result value is always calculated from acquisition data, the default value is arbitrary. Although the Preset/Default values are defined.
Dependencies	Unavailable when “ Meas Method ” on page 517 is set to RBW.
Preset	Result dependent on markers setup and signal source.
State Saved	No
Backwards Compatibility SCPI	:CALCulate:ACPower:MARKer[1] 2 3 4 5 6 7 8 9 10 11 12:FUNCtion:RESult?
Initial S/W Revision	Prior to A.02.00
Modified at S/W Revision	A.02.00, A.03.00
Help Map ID	7061

Properties

Accesses the marker properties menu. Note that this key is unavailable when “[Meas Method](#)” on page 517 is set to RBW.

Key Path	Marker
Initial S/W Revision	Prior to A.02.00
Help Map ID	7096

Select Marker

Displays 12 markers available for selection. Note that this key is unavailable when “[Meas Method](#)” on page 517 is set to RBW.

Key Path	Marker
Initial S/W Revision	Prior to A.02.00
Help Map ID	7103

Relative To

Selects the desired marker. The selected marker will be relative to its reference marker.

Key Path	Marker, Properties
----------	---------------------------

ACP Measurement
Marker

Mode	WCDMA, C2K, WIMAX OFDMA, TD-SCDMA, 1xEVDO, LTE, LTETDD
Remote Command	:CALCulate:ACPower:MARKer [1] 2 3 4 5 6 7 8 9 10 11 12 :R EFerence <integer> :CALCulate:ACPower:MARKer [1] 2 3 4 5 6 7 8 9 10 11 12 :R EFerence?
Example	CALC:ACP:MARK2:REF 6 CALC:ACP:MARK2:REF?
Notes	A marker cannot be relative to itself so that choice is grayed out, and if sent from SCPI generates error -221: "Settings conflict; marker cannot be relative to itself." When queried a single value will be returned (the specified marker numbers relative marker). You must be in the mode that includes ACP measurements to use this command. Use :INSTrument:SELEct to set the mode.
Dependencies	Unavailable when "Meas Method" on page 517 is set to RBW.
Preset	2 3 4 5 6 7 8 9 10 11 12 1
State Saved	Saved in instrument state.
Min	1
Max	12
Initial S/W Revision	Prior to A.02.00
Modified at S/W Revision	A.02.00, A.03.00
Help Map ID	7062

Marker Trace

Selects the trace that you want your marker to be placed on. A marker is associated with one and only one trace. This trace is used to determine the placement, result, and X Axis Scale of the marker. All markers have an associated trace, even **Fixed** markers; it is from that trace that they determine their attributes and behaviors, and it is to that trace that they go when they become Normal or Delta markers.

Key Path	Marker, Properties
Mode	WCDMA, C2K, WIMAX OFDMA, TD-SCDMA, 1xEVDO, LTE, LTETDD
Remote Command	:CALCulate:ACPower:MARKer [1] 2 3 4 5 6 7 8 9 10 11 12 :T RACe 1 2 3 :CALCulate:ACPower:MARKer [1] 2 3 4 5 6 7 8 9 10 11 12 :T RACe?
Example	CALC:ACP:MARK2:TRAC 2 CALC:ACP:MARK2:TRAC?

Notes	<p>If the selected marker is Off, pressing Marker sets it to Normal and places it at the center of the screen on the trace determined by the Marker Trace rules. At the same time, Marker X Axis Value appears on the Active Function area.</p> <p>Default Active Function: the active function for the selected marker's current control mode. If the current control mode is Off, there is no active function and the active function is turned off.</p> <p>Active Function Display: the marker X axis value entered in the active function area will display the marker value to its full entered precision.</p>
Dependencies	Unavailable when " Meas Method " on page 517 is set to RBW.
Couplings	<p>This is not affected by Auto Coupling.</p> <p>Sending the remote command causes the addressed marker to become selected.</p>
Preset	All Markers Off
State Saved	Saved in instrument state.
Range	1 2 3
Initial S/W Revision	Prior to A.02.00
Modified at S/W Revision	A.02.00, A.03.00
Help Map ID	7068

Couple Markers

When this function is On, moving any marker causes an equal X axis movement of every other marker which is not **Off**. By "equal X axis movement" we mean that we preserve the difference between each marker's X axis value (in the fundamental x-axis units of the trace that marker is on) and the X axis value of the marker being moved (in the same fundamental x-axis units).

Key Path	Marker
Mode	WCDMA, C2K, WIMAX OFDMA, TD-SCDMA, 1xEVDO, LTE, LTE-TDD
Remote Command	:CALCulate:ACPower:MARKer:COUPlE[:STATe] ON OFF 1 0 :CALCulate:ACPower:MARKer:COUPlE[:STATe]?
Example	CALC:ACP:MARK:COUP ON
Dependencies	Unavailable when " Meas Method " on page 517 is set to RBW.
Preset	OFF
State Saved	Saved in instrument state.
Range	On Off
Initial S/W Revision	Prior to A.02.00
Modified at S/W Revision	A.02.00, A.03.00

Help Map ID	7063
-------------	------

Marker All Off

Turns all active markers off.

Key Path	Marker
Mode	WCDMA, C2K, WIMAX OFDMA, TD-SCDMA, 1xEVDO, LTE, LTETDD
Remote Command	:CALCulate:ACPower:MARKer:AOff
Example	CALC:ACP:MARK:AOff
Dependencies	Unavailable when “ Meas Method ” on page 517 is set to RBW.
Initial S/W Revision	Prior to A.02.00
Modified at S/W Revision	A.02.00, A.03.00
Help Map ID	7064

Backward Compatibility Remote Commands

Sets or queries the state of a marker. Setting a marker which is off to the on state or 1 puts it in Normal mode and places it at the center of the screen.

Mode	WCDMA, WIMAX OFDMA, C2K, TD-SCDMA, 1xEVDO, LTE, LTETDD
Remote Command	:CALCulate:ACPower:MARKer [1] 2 3 4 5 6 7 8 9 10 11 12 :S TATe OFF ON 0 1 :CALCulate:ACPower:MARKer [1] 2 3 4 5 6 7 8 9 10 11 12 :S TATe?
Example	CALC:ACP:MARK2:STAT ON CALC:ACP:MARK2:STAT?
Notes	This parameter is also accessed from Marker, Properties, 1 You must be in the mode that includes ACP measurements to use this command. Use :INSTrument:SELect to set the mode.
Preset	OFF OFF OFF OFF OFF OFF OFF OFF OFF OFF OFF OFF
State Saved	Saved in instrument state.
Range	On Off
Initial S/W Revision	Prior to A.02.00
Modified at S/W Revision	A.02.00, A.03.00
Help Map ID	7065

Marker Function

There are no Marker Functions supported in the ACP measurement. The front-panel key will display a blank menu when pressed.

Key Path	Front-panel key
Initial S/W Revision	Prior to A.02.00
Help Map ID	7101

Marker To

There is no Marker To functionality supported in ACP. The front-panel key will display a blank menu when pressed.

Key Path	Front-panel key
Initial S/W Revision	Prior to A.02.00
Help Map ID	7100

Meas

See Meas@4008@i for more information.

Key Path	Front-panel key
Initial S/W Revision	Prior to A.02.00
Help Map ID	0

Meas Setup

Displays the setup menu for the currently selected measurement. The functions included in the measurement setup menu include setting the parameters for the carriers, offsets, bandwidths, measurement methods and types. This menu also allows you to turn noise correction on and off.

Key Path	Front-panel key
Initial S/W Revision	Prior to A.02.00
Help Map ID	7084

Average/Hold Number

Specifies the number of measurement averages used to calculate the measurement result. The average will be displayed at the end of each sweep. After the specified number of average counts, the average mode (termination control) setting determines the average action.

Key Path	Meas Setup
Mode	WCDMA, C2K, WIMAX OFDMA, TD-SCDMA, 1xEVDO, LTE, LTETDD
Remote Command	[:SENSE]:ACPpower:AVERage:COUNT <integer> [:SENSE]:ACPpower:AVERage:COUNT? [:SENSE]:ACPpower:AVERage[:STATe] OFF ON 0 1 [:SENSE]:ACPpower:AVERage[:STATe]?
Example	ACP:AVER:COUN 250 ACP:AVER:COUN? ACP:AVER OFF ACP:AVER?
Notes	You must be in the mode that includes ACP measurements to use this command. Use :INSTRument:SElect to set the mode.
Preset	10 ON
State Saved	Saved in instrument state.
Min	1
Max	1000
Backwards Compatibility SCPI	[:SENSE]:ACPR:AVERage:COUNT [:SENSE]:MCPower:AVERage:COUNT (PSA Power Suite, PSA W-CDMA, PSA cdma2000)
Initial S/W Revision	Prior to A.02.00

Modified at S/W Revision	A.02.00, A.03.00
Help Map ID	7014

Avg Mode

Enables you to set the averaging mode. This determines the averaging action after the specified number of data acquisitions (average count) is reached.

When set to Exponential (Exp) the measurement averaging continues using the specified number of averages to compute each averaged value. The average will be displayed at the end of each sweep.

When set to Repeat, the measurement resets the average counter each time the specified number of averages is reached.

Key Path	Meas Setup
Mode	WCDMA, C2K, WIMAX OFDMA, TD-SCDMA, 1xEVDO, LTE, LTETDD
Remote Command	[:SENSE] :ACPower:AVERage:TCONtrol EXPonential REPEAT [:SENSE] :ACPower:AVERage:TCONtrol?
Example	ACP:AVER:TCON EXP ACP:AVER:TCON?
Notes	You must be in the mode that includes ACP measurements to use this command. Use :INSTrument:SElect to set the mode.
Preset	EXponential
State Saved	Saved in instrument state.
Range	Exp Repeat
Backwards Compatibility SCPI	[:SENSe] :ACPR:AVERage:TCONtrol
Initial S/W Revision	Prior to A.02.00
Modified at S/W Revision	A.02.00, A.03.00
Help Map ID	7015

Carrier Setup

Accesses a menu that contains Carriers, Ref Carrier, Ref Car Freq, Ref Car Pwr and Configure Carriers.

Key Path	Meas Setup
Initial S/W Revision	Prior to A.02.00
Help Map ID	7085

Carriers

Specifies the number of carriers to be measured.

Key Path	Meas Setup, Carrier Setup, Configure Carriers
Mode	WCDMA, C2K, WIMAX OFDMA, 1xEVDO, TD-SCDMA, LTE, LTETDD
Remote Command	[:SENSE] :ACPpower:CARRIER [1] 2:COUNT <integer> [:SENSE] :ACPpower:CARRIER [1] 2:COUNT?
Example	ACP:CARR:COUN 1 ACP:CARR:COUN?
Notes	Carrier sub op code. 1 for BTS, 2 for MS. Default is BTS. You must be in the mode that includes ACP measurements to use this command. Use :INSTrument:SElect to set the mode.
Dependencies	When Number of Carriers is 1, Ref Carrier is grayed out. If N9060A-5FP license is enabled, Max of Carrier is 18, otherwise, Max of Carrier is 12.
Couplings	Changing this parameter might affect to the Span.
Preset	1
State Saved	Saved in instrument state.
Min	1
Max	12
Initial S/W Revision	Prior to A.02.00
Modified at S/W Revision	A.02.00, A.03.00
Help Map ID	7016

Ref Carrier

Sets the reference carrier. Relative power measurements are made from the reference carrier.

If set to Auto, the measurement selects the carrier with the highest power as the reference carrier and the Ref Carrier parameter is updated. If a value is entered when Ref Carrier Mode is set to Auto, the mode changes to Man.

If set to Man, the value that you enter for the Ref Carrier is used as the reference carrier.

Key Path	Meas Setup, Carrier Setup
Mode	WCDMA, C2K, WIMAX OFDMA, 1xEVDO, TD-SCDMA, LTE, LTETDD

Remote Command	<pre>[:SENSE] :ACPower:CARRier [1] 2:RCARrier <integer> [:SENSE] :ACPower:CARRier [1] 2:RCARrier? [:SENSE] :ACPower:CARRier [1] 2:RCARrier:AUTO OFF ON 0 1 [:SENSE] :ACPower:CARRier [1] 2:RCARrier:AUTO?</pre>
Example	<pre>ACP:CARR:RCAR 1 ACP:CARR:RCAR? ACP:CARR:RCAR:AUTO OFF ACP:CARR:RCAR:AUTO?</pre>
Notes	<p>Carrier sub op code. 1 for BTS, 2 for MS. Default is BTS.</p> <p>You must be in the mode that includes ACP measurements to use this command. Use :INSTrument:SELEct to set the mode.</p>
Dependencies	If there is only one carrier, this key will be grayed out.
Couplings	<p>If you enter a carrier value that is currently configured as having no power present, that carrier will be changed to having power present.</p> <p>If you enter a ref carrier this parameter will be set to manual.</p>
Preset	Auto determined
State Saved	Saved in instrument state.
Min	1
Max	Number of available carriers
Backwards Compatibility SCPI	[:SENSe]:MCPower:RCARrier[1] 2 (PSA Power Suite)
Initial S/W Revision	Prior to A.02.00
Modified at S/W Revision	A.02.00, A.03.00
Help Map ID	7017

Ref Car Freq

Sets the reference carrier frequency.

Key Path	Meas Setup, Carrier Setup
Mode	WCDMA, C2K, WIMAX OFDMA, 1xEVDO, TD-SCDMA, LTE, LTETDD
Remote Command	<pre>[:SENSE] :ACPower:CARRier [1] 2:RCFFrequency <freq> [:SENSE] :ACPower:CARRier [1] 2:RCFFrequency? [:SENSE] :ACPower:CARRier [1] 2:RCFFrequency:AUTO OFF ON 0 1 [:SENSE] :ACPower:CARRier [1] 2:RCFFrequency:AUTO?</pre>

ACP Measurement
Meas Setup

Example	ACP:CARR:RCFR 250 MHz ACP:CARR:RCFR? ACP:CARR:RCFR:AUTO OFF ACP:CARR:RCFR:AUTO?
Notes	Carrier sub op code. 1 for BTS, 2 for MS. Default is BTS. You must be in the mode that includes ACP measurements to use this command. Use :INSTrument:SELEct to set the mode.
Couplings	Coupled to the Center Frequency. If the center frequency changes, the Ref Carrier Frequency is calculated using the following three steps; Ref Freq1 = Ctr Freq - (Total of all Carrier Widths / 2) Ref Freq2 = Ref Freq1 + (Total of all Carrier Widths up to Ref Carrier) Ref Freq = Ref Freq2 + (0.5 * Carrier Width of Ref Carrier) If reference carrier frequency changes the Center Frequency is calculated using the following three steps; Ctr Freq1 = Ref Freq - (0.5 * Carrier Width of Ref Carrier) Ctr Freq2 = Ctr Freq1 - (Total of all Carrier Widths up to Ref Carrier) Ctr Freq = Ctr Freq2 + (Total of all Carrier Widths / 2) This ensures that the carriers are always centered on the screen. If there is only one carrier present the Reference Carrier Frequency will be the same as the Center Frequency.
Preset	Calculated based on the current Center Frequency
State Saved	Saved in instrument state.
Min	-79.999995 MHz
Max	Hardware Dependent: Option 503 = 3.699999995 GHz Option 504 = 3.899999995 GHz
Initial S/W Revision	Prior to A.02.00
Modified at S/W Revision	A.02.00, A.03.00
Help Map ID	7018

Power Ref

Sets the power reference in the carrier that will be used to compute the relative values for the offsets.

Key Path	Meas Setup, Carrier Setup
Initial S/W Revision	Prior to A.02.00

Modified at S/W Revision	A.03.00, A.04.00
Help Map ID	7111

Total Power

Sets the multi-carrier power reference.

When set to Auto, the carrier power result reflects the measured power value in the selected reference carrier.

When set to Man, the result is referenced to the last measured value, or you may specify the reference for the multi-carrier power measurement. Relative values are displayed, referenced to the “Power Reference” value.

Key Path	Meas Setup, Carrier Setup, Power Ref
Mode	WCDMA, C2K, WIMAX OFDMA, TD-SCDMA, LTE, LTETDD
Remote Command	[:SENSe]:ACPower:CARRier[1] 2[:POWER] <real> [:SENSe]:ACPower:CARRier[1] 2[:POWER]? [:SENSe]:ACPower:CARRier[1] 2:AUTO[:STATe] OFF ON 0 1 [:SENSe]:ACPower:CARRier[1] 2:AUTO[:STATe]?
Example	ACP:CARR 10 ACP:CARR? ACP:CARR:AUTO OFF ACP:CARR:AUTO?
Notes	Although the default value is defined, the value is recalculated by the measurement result just after measurement. Carrier sub op code. 1 for BTS, 2 for MS. Default is BTS. You must be in the mode that includes ACP measurements to use this command. Use :INSTrument:SElect to set the mode.
Dependencies	This key is available only when the Meas Type is TPRef. If the Meas Type is not TPRef, this key is grayed out.
Preset	0.0 ON
State Saved	Saved in instrument state.
Min	-200 dBm
Max	200 dBm
Backwards Compatibility SCPI	[:SENSe]:MCPower:CARRier[1] 2[:POWER]
Initial S/W Revision	Prior to A.02.00
Modified at S/W Revision	A.02.00, A.03.00, A.04.00

ACP Measurement
Meas Setup

Help Map ID	7019
-------------	------

PSD

Sets the power spectral density in the carrier (main channel) that is used to compute the relative power spectral density values for the offsets when Meas Type is set to PSD Ref. When the PSD Ref state is set to Auto, this will be set to the measured carrier power spectral density.

Key Path	Meas Setup, Carrier Setup, Power Ref
Mode	WCDMA, C2K, WIMAX OFDMA, TD-SCDMA, LTE, LTETDD
Remote Command	[:SENSE] :ACPower:CARRier [1] 2:CPD <real> [:SENSE] :ACPower:CARRier [1] 2:CPD?
Example	ACP:CARR:CPD 25 ACP:CARR:CPD?
Notes	Although the default value is defined, the value is recalculated by the measurement result just after measurement. Carrier sub op code. 1 for BTS, 2 for MS. Default is BTS. You must be in the mode that includes ACP measurements to use this command. Use :INSTrument:SELEct to set the mode.
Dependencies	This key is available only when the Meas Type is PSDRef. If the Meas Type is not PSDRef, this key is grayed out.
Couplings	The value of PSD is automatically converted when PSD Unit is changed.
Preset	0.0
State Saved	Saved in instrument state.
Min	-999
Max	999
Initial S/W Revision	Prior to A.02.00
Modified at S/W Revision	A.02.00, A.03.00, A.04.00
Help Map ID	7020

Configure Carriers

Accesses a menu that contains Carrier, Carrier Pwr Present, Carrier Width and Carrier Integ BW parameters.

Key Path	Meas Setup, Carrier Setup
Initial S/W Revision	Prior to A.02.00
Help Map ID	7086

Carrier

Selects the carrier to configure for the current measurement.

Key Path	Meas Setup, Carrier Setup, Configure Carriers
Mode	WCDMA, C2K, WIMAX OFDMA, 1xEVDO, TD-SCDMA, LTE, LTETDD
Couplings	Max value is the number of available carriers, so this value might change when the number of carriers is changed.
Preset	1
State Saved	No
Min	1
Max	Number of available carriers
Initial S/W Revision	Prior to A.02.00
Modified at S/W Revision	A.02.00, A.03.00
Help Map ID	7021

Carrier Coupling

Couples carrier settings to carrier #1. The coupled parameters are Carrier Power Present, Carrier Spacing, Measurement Noise Bandwidth, Method, and Filter Alpha.

Key Path	Meas Setup, Carrier Setup, Configure Carriers
Mode	WCDMA, C2K, WIMAX OFDMA, 1xEVDO, TD-SCDMA, LTE, LTETDD
Remote Command	[:SENSE] :ACPower:CARRIER [1] 2:LIST:COUPLE OFF ON 0 1, OFF ON 0 1, OFF ON 0 1, OFF ON 0 1, OFF ON 0 1, OFF ON 0 1 [:SENSE] :ACPower:CARRIER [1] 2:LIST:COUPLE?
Example	ACP:CARR:LIST:COUP OFF ACP:CARR:LIST:COUP?
Notes	Carrier sub op code. 1 for BTS, 2 for MS. Default is BTS. You must be in the mode that includes ACP measurements to use this command. Use :INSTrument:SElect to set the mode.
Couplings	When Couple is selected, the carrier settings are coupled to carrier #1. Coupled parameters are Carrier Power Present, Carrier Spacing, Measurement Noise Bandwidth, Method and Filter Alpha. When a setting is changed, the couple is set to Man automatically. Carrier #1 is always set to couple and cannot be changed. Couple/Man selection on the Carrier key is not displayed when selected carrier number is #1.

Preset	ON
State Saved	Saved in instrument state.
Range	Couple Man
Initial S/W Revision	Prior to A.02.00
Modified at S/W Revision	A.02.00, A.03.00
Help Map ID	7022

Carrier Pwr Present

Configures the carriers for this measurement. It allows spaces to be inserted between carriers. Carriers with the power present parameter set to Yes are carriers, and those with the power present parameter set to No are spaces. Each carrier power present is set to Yes or No. The individual carriers can be set by selecting the desired carrier on the carrier menu key using the up down arrows, the knob, or numeric keypad, then toggling the carrier power present using the carrier power present menu key.

The query for this parameter returns the current values for all of the carriers. If a carrier is defined as having no power present, the power displayed will be relative to the reference carrier, otherwise the absolute power will be displayed.

If you change the carrier power present to no and that carrier is currently configured as the reference carrier, the next carrier to the left (or the right if there are no carriers to the left) will be assigned as the reference carrier. This also applies to the scenario where there are only two carriers configured as having power present and you configure only one carrier to have no power present.

Key Path	Meas Setup, Carrier Setup, Configure Carriers
Mode	WCDMA, C2K, WIMAX OFDMA, 1xEVDO, TD-SCDMA, LTE, LTETDD
Remote Command	[:SENSe] :ACPower:CARRier [1] 2:LIST:PPResent YES NO, ... [:SENSe] :ACPower:CARRier [1] 2:LIST:PPResent?
Example	ACP:CARR2:LIST:PPR YES ACP:CARR2:LIST:PPR?
Notes	Carrier sub op code. 1 for BTS, 2 for MS. Default is BTS. When setting these values remotely, the position in the list sent corresponds to the carrier. Missing values are not permitted, therefore if you want to change values 2 and 6 you must send all values up to 6. Subsequent values will remain unchanged, unless the number of values sent is greater than the number of carriers, then subsequent values will be ignored.
Dependencies	If there is only one carrier, this key will be grayed out.
Couplings	Coupled to the number of carriers. When the SCPI command is sent, the number of carriers will be set to the number of entries in the parameter list.
Preset	YES
State Saved	Saved in instrument state.

Range	Yes No
Backwards Compatibility SCPI	[[:SENSe]:MCPower:CARRier[1]]2:LIST:PPResent (PSA Power Suite)
Initial S/W Revision	Prior to A.02.00
Modified at S/W Revision	A.02.00, A.03.00
Help Map ID	7023

Carrier Spacing

Sets the width of the carrier spacing. This will be the value applied to all the current slots, whether they are carriers or spaces.

Enter each carrier spacing value individually by selecting the desired carrier on the carrier menu key using the up down arrows, the knob, or the numeric keypad, then enter the carrier width using the carrier spacing menu key.

Key Path	Meas Setup, Carrier Setup, Configure Carriers
Mode	WCDMA, C2K, WIMAX OFDMA, 1xEVDO, TD-SCDMA, LTE, LTETDD
Remote Command	[[:SENSe]:ACPower:CARRier[1] 2:LIST:WIDTh <bandwidth>, ... [:SENSe]:ACPower:CARRier[1] 2:LIST:WIDTh?
Example	ACP:CARR2:LIST:WIDT 25kHz ACP:CARR2:LIST:WIDT?
Notes	Carrier sub op code. 1 for BTS, 2 for MS. Default is BTS. When setting these values remotely, the position in the list sent corresponds to the carrier. Missing values are not permitted, therefore if you want to change values 2 and 6 you must send all values up to 6. Subsequent values will remain unchanged, unless the number of values sent is greater than the number of carriers, then subsequent values will be ignored. You must be in the mode that includes ACP measurements to use this command. Use :INSTrument:SELect to set the mode.
Couplings	Coupled to the number of carriers. When the SCPI command is sent, the number of carriers will be set to the number of entries in the parameter list. Changing Carrier Spacing might affect the Span.
Preset	WCDMA: 5 MHz WIMAX OFDMA: 10 MHz C2K: 1.25 MHz 1xEVDO: 1.25 MHz TD-SCDMA: 1.6 MHz LTE: 5 MHz LTETDD: 5 MHz

ACP Measurement
Meas Setup

State Saved	Saved in instrument state.
Min	0 Hz
Max	1 GHz
Backwards Compatibility SCPI	[:SENSE]:MCPower:CARRier[1]2:LIST:WIDTh (PSA Power Suite)
Initial S/W Revision	Prior to A.02.00
Modified at S/W Revision	A.02.00, A.03.00
Help Map ID	7024

Measurement Noise Bandwidth

Specifies the Measurement Noise Bandwidth used to calculate the power in the carriers.

Each Measurement Noise Bandwidth value is entered individually by selecting the desired carrier on the carrier menu key using the up down arrows, the knob, or the numeric keypad. Then enter the measurement noise bandwidth using the measurement noise bandwidth key.

Key Path	Meas Setup, Carrier Setup, Configure Carriers
Mode	WCDMA, C2K, WIMAX OFDMA, TD-SCDMA, 1xEVDO, LTE, LTETDD
Remote Command	[:SENSE]:ACPpower:CARRier[1] 2:LIST:BANDwidth[:INTEgrati on] <freq>, ... [:SENSE]:ACPpower:CARRier[1] 2:LIST:BANDwidth[:INTEgrati on] ?
Example	ACP:CARR2:LIST:BAND 25kHz ACP:CARR2:LIST:BAND?
Notes	In the WCDMA mode, the preset/default value is defined as 3.84 MHz. But internally, 4.6848 MHz is used as the default value. Carrier sub op code. 1 for BTS, 2 for MS. Default is BTS. When setting these values remotely, the position in the list sent corresponds to the carrier. Missing values are not permitted, therefore if you want to change values 2 and 6 you must send all values up to 6. Subsequent values will remain unchanged, unless the number of values sent is greater than the number of carriers, then subsequent values will be ignored. You must be in the mode that includes ACP measurements to use this command. Use :INSTRument:SElect to set the mode.
Couplings	Coupled to the number of carriers. When the SCPI command is sent, the number of carriers is set to the number of entries in the parameter list.

Preset	WCDMA: 3.84 MHz WIMAX OFDMA: 10 MHz C2K: 1.23 MHz TD-SCDMA: 1.28 MHz 1xEVDO: 1.23 MHz LTE, LTETDD: 4.515 MHz 4.5 MHz
State Saved	Saved in instrument state.
Min	10 Hz
Max	1 GHz
Backwards Compatibility SCPI	[:SENSe]:ACPower:BANDwidth:INTEgration [:SENSe]:ACPower:BWIDth:INTEgration [:SENSe]:ACPower:CARRier[1] 2:LIST:BWIDth[:INTEgration] [:SENSe]:MCPower:CARRier[1] 2:LIST:BANDwidth[:INTEgration] (PSA Power Suite) [:SENSe]:MCPower:CARRier[1] 2:LIST:BWIDth[:INTEgration] (PSA Power Suite)
Help Map ID	7025

Method for Carrier

Accesses the carrier configuration method settings.

Key Path	Meas Setup, Carrier Setup, Configure Carriers
Mode	WCDMA, WIMAX OFDMA, TD-SCDMA, LTE, LTETDD
Remote Command	[:SENSe]:ACPower:CARRier[1] 2:LIST:FILTer[:RRC][:STATE] ON OFF 1 0, ... [:SENSe]:ACPower:CARRier[1] 2:LIST:FILTer[:RRC][:STATE] ?
Example	ACP:CARR:LIST:FILT 0,0,0 ACP:CARR:LIST:FILT?
Notes	The binary values translate as follows: 1 ON = RRC Weighted 0 OFF = Integ BW Maximum of Array length depends on the number of carriers. You must be in the mode that includes ACP measurements to use this command. Use :INSTrument:SElect to set the mode.

ACP Measurement
Meas Setup

Preset	LTE, LTETDD: OFF WCDMA: ON WIMAX OFDMA: OFF TD-SCDMA: ON
State Saved	Saved in instrument state.
Range	IntegBW RRC Weight
Initial S/W Revision	Prior to A.02.00
Modified at S/W Revision	A.02.00, A.03.00
Help Map ID	7026

Filter Alpha for Carrier

Inputs the alpha value for the filter used in the current carrier configuration.

Key Path	Meas Setup, Carrier Setup, Configure Carriers, Method, RRC Weighted
Mode	WCDMA, WIMAX OFDMA, TD-SCDMA, LTE, LTETDD
Remote Command	[:SENSe] :ACPowEr:CARRier [1] 2:LIST:FILTer:ALPHa <real>, ... [:SENSe] :ACPowEr:CARRier [1] 2:LIST:FILTer:ALPHa?
Example	ACP:CARR2:LIST:FILT:ALPH 0.5 ACP:CARR2:LIST:FILT:ALPH?
Notes	You must be in the mode that includes ACP measurements to use this command. Use :INSTrument:SELEct to set the mode.
Preset	0.22 C2K: No DTMB: 0.05
State Saved	Saved in instrument state.
Min	0.01
Max	1.0
Initial S/W Revision	Prior to A.02.00
Modified at S/W Revision	A.02.00, A.03.00
Help Map ID	7027

Offset/Limits

Accesses a menu of functions that contains Offset, Offset Freq/Offset To Edge, Offset Integ BW, Upper

Offset Limit and Lower Offset parameters.

Key Path	Meas Setup
Initial S/W Revision	Prior to A.02.00
Help Map ID	7087

Select Offset

Selects the offset to configure.

Key Path	Meas Setup, Offset/Limits, Limits
Mode	WCDMA, C2K, WIMAX OFDMA, TD-SCDMA, 1xEVDO, LTE
Preset	A
State Saved	Saved in instrument state.
Range	Offset A Offset B Offset C Offset D Offset E Offset F
Initial S/W Revision	Prior to A.02.00
Modified at S/W Revision	A.02.00, A.03.00
Help Map ID	7028

Offset Freq

This parameter determines the frequency difference between the center of the main channel and the center of the carrier.

Each Offset Freq state value is entered individually by selecting the desired carrier on the carrier menu key using the up down arrows, RPG or numeric keypad. Then enter the Offset Freq State using the Offset Frequency key.

The list contains up to six (6) entries, depending on the mode selected, for offset frequencies. Each offset frequency in the list corresponds to a reference bandwidth in the bandwidth list.

An offset frequency of zero turns the display of the measurement for that offset off, but the measurement is still made and reported. You can turn off (not use) specific offsets with the [:SENSe]:ACP:OFFSet:LIST:STATE command

Turning the offset off has the same effect as setting the frequency of the offset to 0 Hz and will cause it to be removed from the results screen.

Key Path	Meas Setup, Offset/Limits
Mode	WCDMA, C2K, WIMAX OFDMA, TD-SCDMA, 1xEVDO, LTE

ACP Measurement
Meas Setup

<p>Remote Command</p>	<pre>[:SENSe] :ACPower:OFFSet [1] 2:LIST[:FREQuency] <freq>, <freq>, <freq>, <freq>, <freq> [:SENSe] :ACPower:OFFSet [1] 2:LIST[:FREQuency]? [:SENSe] :ACPower:OFFSet [1] 2:LIST:STATe OFF ON 0 1, OFF ON 0 1, OFF ON 0 1, OFF ON 0 1, OFF ON 0 1, OFF ON 0 1 [:SENSe] :ACPower:OFFSet [1] 2:LIST:STATe?</pre>
<p>Example</p>	<pre>ACP:OFFS1:LIST 0,0,0,0,0 ACP:OFFS1:LIST? ACP:OFFS2:LIST:STAT 1,1,0,0,0 ACP:OFFS2:LIST:STAT?</pre>
<p>Notes</p>	<p>The label for this menu key will change depending on the currently selected radio standard or mode. For cdma2000 the label for the menu key will be Offset to Edge. For all other supported standards the label will be Offset Freq.</p> <p>When setting these values remotely, the position in the list sent corresponds to the offset. Missing values are not permitted, unless the number of values sent is greater than the number of carriers, then subsequent values will be ignored.</p> <p>Offset sub op code. 1 for BTS, 2 for MS. Default is BTS.</p> <p>You must be in the mode that includes ACP measurements to use this command. Use :INSTrument:SELEct to set the mode.</p>
<p>Couplings</p>	<p>Changing Offset Frequency might affect the Span. See the Span key section for details.</p>

Preset	<p>WCDMA: 5.0 MHz, 10.0 MHz, 0 Hz, 0 Hz, 0 Hz, 0 Hz 5.0 MHz, 10.0 MHz, 0 Hz, 0 Hz, 0 Hz, 0 Hz</p> <p>WIMAX OFDMA: 10 MHz, 20 MHz, 0 Hz, 0 Hz, 0 Hz, 0 Hz 10 MHz, 20 MHz, 0 Hz, 0 Hz, 0 Hz, 0 Hz</p> <p>C2K: 765 kHz, 1.995 MHz, 0 Hz, 0 Hz, 0 Hz, 0 Hz 900 kHz, 1.995 MHz, 0 Hz, 0 Hz, 0 Hz, 0 Hz</p> <p>TD-SCDMA: 1.6 MHz, 3.2 MHz, 0 Hz, 0 Hz, 0 Hz, 0 Hz 1.6 MHz, 3.2 MHz, 0 Hz, 0 Hz, 0 Hz, 0 Hz</p> <p>1xEVDO: 765 kHz, 1.995 MHz, 3.125 MHz, 4.000 MHz, 7.500 MHz, 7.500 MHz 765 kHz, 1.995 MHz, 3.125 MHz, 4.000 MHz, 7.500 MHz, 7.500 MHz</p> <p>LTE, LTETDD: 5 MHz, 10 MHz, 0, 0, 0, 0 5 MHz, 10 MHz, 0, 0, 0, 0</p> <p>SA: ON, OFF, OFF, OFF, OFF, OFF ON, OFF, OFF, OFF, OFF, OFF</p> <p>WCDMA: ON, ON, OFF, OFF, OFF, OFF ON, ON, OFF, OFF, OFF, OFF</p> <p>WIMAX OFDMA: ON, ON, OFF, OFF, OFF, OFF ON, ON, OFF, OFF, OFF, OFF</p> <p>TD-SCDMA: ON, ON, OFF, OFF, OFF, OFF ON, ON, OFF, OFF, OFF, OFF</p> <p>CDMA 1xEVDO: ON, ON, OFF, OFF, OFF, OFF ON, ON, OFF, OFF, OFF, OFF</p> <p>LTE, LTETDD: ON, ON, OFF, OFF, OFF, OFF ON, OFF, OFF, OFF, OFF, OFF</p>
State Saved	Saved in instrument state.
Min	0 Hz
Max	500 MHz
Backwards Compatibility SCPI	[:SENSe]:MCPower:OFFSet[1] 2:LIST[:FREQuency] (PSA Power Suite)
Initial S/W Revision	Prior to A.02.00
Modified at S/W Revision	A.02.00, A.03.00
Help Map ID	7029

Integ BW

Sets the Integration Bandwidth for the offsets. If there is more than one bandwidth, the list must contain six (6) entries. Each resolution bandwidth in the list corresponds to an offset frequency in the list defined by [:SENSe]:ACP:OFFSet[n]:LIST[:FREQuency].

Enter each value individually by selecting the desired offset on the offset menu key using the up down arrows, the knob, or the numeric keypad, then enter the Offset Integration Bandwidth using the Offset Integration Bandwidth menu key.

You can turn off (not use) specific offsets with the [:SENSe]:ACP:OFFSet[n]:LIST:STATe command."

Key Path	Meas Setup, Offset/Limits
----------	---------------------------

ACP Measurement
Meas Setup

Mode	WCDMA, C2K, WIMAX OFDMA, TD-SCDMA, 1xEVDO, LTE, LTETDD
Remote Command	[:SENSe]:ACPower:OFFSet [1] 2:LIST:BANDwidth[:INTEgratio n] <bandwidth>, <bandwidth>, <bandwidth>, <bandwidth>, <bandwidth>, <bandwidth> [:SENSe]:ACPower:OFFSet [1] 2:LIST:BANDwidth[:INTEgratio n] ?
Example	ACP:OFFS2:LIST:BAND 2 MHz, 2 MHz, 2 MHz, 2 MHz, 2 MHz, 2 MHz ACP:OFFS2:LIST:BAND?
Notes	When setting these values remotely, the position in the list sent corresponds to the offset. Missing values are not permitted i.e. if you want to change values 2 you must send all values up to 2. Subsequent values will remain unchanged, unless the number of values sent is greater than the number of carriers, then subsequent values will be ignored. Offset sub op code. 1 for BTS, 2 for MS. Default is BTS. You must be in the mode that includes ACP measurements to use this command. Use :INSTrument:SELEct to set the mode.
Couplings	Changing Integ BW might affect to the Span. See Span section for details.
Preset	WCDMA: 3.84 MHz, 3.84 MHz, 3.84 MHz, 3.84 MHz, 3.84 MHz, 3.84 MHz 3.84 MHz, 3.84 MHz, 3.84 MHz, 3.84 MHz, 3.84 MHz, 3.84 MHz WIMAX OFDMA: 10 MHz, 10 MHz, 10 MHz, 10 MHz, 10 MHz, 10 MHz 10 MHz, 10 MHz, 10 MHz, 10 MHz, 10 MHz, 10 MHz C2K: 30 kHz, 30 kHz, 30 kHz, 30 kHz, 30 kHz, 30 kHz 30 kHz, 30 kHz, 30 kHz, 30 kHz, 30 kHz, 30 kHz TD-SCDMA: 1.28 MHz, 1.28 MHz, 1.28 MHz, 1.28 MHz, 1.28 MHz, 1.28 MHz 1xEVDO: C2K: 30 kHz, 30 kHz, 30 kHz, 30 kHz, 30 kHz, 30 kHz 30 kHz, 30 kHz, 30 kHz, 30 kHz, 30 kHz, 30 kHz LTE, LTETDD: 4.515 MHz, 4.515 MHz, 4.515 MHz, 4.515 MHz, 4.515 MHz, 4.515 MHz 4.5 MHz, 4.5 MHz, 4.5 MHz, 4.5 MHz, 4.5 MHz, 4.5 MHz
State Saved	Saved in instrument state.
Min	10 Hz
Max	1 GHz
Backwards Compatibility SCPI	[:SENSe]:ACPower:OFFSet[1] 2:LIST:BWIDth[:INTEgration] [:SENSe]:ACPR:OFFSet[1] 2:LIST:BANDwidth [:SENSe]:ACPR:OFFSet[1] 2:LIST:BWIDth [:SENSe]:MCPower:OFFSet[1] 2:LIST:BANDwidth[:INTEgration] (PSA Power Suite) [:SENSe]:MCPower:OFFSet[1] 2:LIST:BWIDth[:INTEgration] (PSA Power Suite)

Initial S/W Revision	Prior to A.02.00
Modified at S/W Revision	A.02.00, A.03.00
Help Map ID	7030

Offset BW

Accesses the offset bandwidth menu.

Key Path	Meas Setup, Offset/Limits
Initial S/W Revision	Prior to A.02.00
Help Map ID	7088

Res BW

Sets the resolution bandwidth. If an unavailable bandwidth is entered with the numeric keypad, the closest available bandwidth is selected.

Key Path	Meas Setup, Offset/Limits
Mode	WCDMA, C2K, 1xEVDO, LTE
Remote Command	<pre>[:SENSE] :ACPower:OFFSet [1] 2 :LIST:BANDwidth:RESolution <bandwidth>, <bandwidth>, <bandwidth>, <bandwidth>, <bandwidth>, <bandwidth> [:SENSE] :ACPower:OFFSet [1] 2 :LIST:BANDwidth:RESolution? [:SENSE] :ACPower:OFFSet [1] 2 :LIST:BANDwidth:RESolution: AUTO ON OFF 1 0, ON OFF 1 0, ON OFF 1 0, ON OFF 1 0, ON OFF 1 0, ON OFF 1 0 [:SENSE] :ACPower:OFFSet [1] 2 :LIST:BANDwidth:RESolution: AUTO?</pre>
Example	<pre>ACP:OFFS2:LIST:BAND:RES 220kHz,220kHz,220kHz,220kHz,220kHz,220kHz ACP:OFFS2:LIST:BAND:RES? ACP:OFFS2:LIST:BAND:RES:AUTO 1,1,1,1,1,1 ACP:OFFS2:LIST:BAND:RES:AUTO?</pre>
Notes	<p>This key is available only in the IBW mode.</p> <p>Offset sub op code. 1 for BTS, 2 for MS. Default is BTS.</p> <p>You must be in the mode that includes ACP measurements to use this command. Use :INSTrument:SElect to set the mode.</p>
Couplings	<p>When Res BW Mode is AUTO, this value is exactly same as Res BW under BW key. And when this value is changed by user, Res BW Mode is also changed to Man.</p>

ACP Measurement
Meas Setup

Preset	<p>WCDMA: 100 kHz, 100 kHz, 100 kHz, 100 kHz, 100 kHz, 100 kHz</p> <p>C2K:</p> <p>Method: RBW</p> <p>30 K</p> <p>Method: IBW</p> <p>C2K: 15 kHz, 15 kHz, 15 kHz, 15 kHz, 15 kHz, 15 kHz 15 kHz, 15 kHz, 15 kHz, 15 kHz, 15 kHz</p> <p>1xEVDO: 3 kHz, 30 kHz, 30 kHz, 30 kHz, 30 kHz, 30 kHz 3 kHz, 30 kHz, 30 kHz, 30 kHz, 30 kHz, 30 kHz</p> <p>LTE: 100 kHz, 100 kHz, 100 kHz, 100 kHz, 100 kHz, 100 kHz 100 kHz, 100 kHz, 100 kHz, 100 kHz, 100 kHz</p> <p>1, 1, 1, 1, 1, 1</p>
State Saved	Saved in instrument state.
Min	1 Hz
Max	8 MHz
Backwards Compatibility SCPI	[[:SENSE]:ACPower:OFFSet[1]]2:LIST:BWIDth:RESolution
Initial S/W Revision	Prior to A.02.00
Modified at S/W Revision	A.02.00, A.03.00
Help Map ID	7031

Video BW

Enables you to change the test set post-detection filter (VBW).

Key Path	Meas Setup, Offset/Limits, Offset BW
Mode	WCDMA, C2K, WIMAX OFDMA, TD-SCDMA, 1xEVDO, LTE, LTETDD
Remote Command	<p>[[:SENSE]:ACPower:OFFSet [1] 2:LIST:BANDwidth:VIDeo <freq>, <freq>, <freq>, <freq>, <freq>, <freq></p> <p>[[:SENSE]:ACPower:OFFSet [1] 2:LIST:BANDwidth:VIDeo?</p> <p>[[:SENSE]:ACPower:OFFSet [1] 2:LIST:BANDwidth:VIDeo:AUTO OFF ON 0 1, OFF ON 0 1, OFF ON 0 1, OFF ON 0 1, OFF ON 0 1, OFF ON 0 1</p> <p>[[:SENSE]:ACPower:OFFSet [1] 2:LIST:BANDwidth:VIDeo:AUTO?</p>
Example	<p>ACP:OFFS2:LIST:BAND:VID 5 MHz, 5 MHz, 5 MHz, 5 MHz, 5 MHz, 5 MHz</p> <p>ACP:OFFS2:LIST:BAND:VID?</p> <p>ACP:OFFS2:LIST:BAND:VID:AUTO 0,0,0,0,1,1</p> <p>ACP:OFFS2:LIST:BAND:VID:AUTO?</p>

Notes	The values shown in this table reflect the conditions after a Mode Preset. Offset sub op code. 1 for BTS, 2 for MS. Default is BTS. You must be in the mode that includes ACP measurements to use this command. Use :INSTrument:SELEct to set the mode.
Preset	SA: 22 kHz, 22 kHz, 22 kHz, 22 kHz, 22 kHz, 22 kHz WCDMA, WIMAX OFDMA: 1 MHz, 1 MHz, 1 MHz, 1 MHz, 1 MHz, 1 MHz C2K: 150 kHz, 150 kHz, 150 kHz, 150 kHz, 150 kHz, 150 kHz 150 kHz, 150 kHz, 150 kHz, 150 kHz, 150 kHz TD-SCDMA: 300 kHz, 300 kHz, 300 kHz, 300 kHz, 300 kHz, 300 kHz 1xEVDO: 30 kHz, 300 kHz, 300 kHz, 300 kHz, 300 kHz, 300 kHz 30 kHz, 300 kHz, 300 kHz, 300 kHz, 300 kHz LTE, LTETDD: 1 MHz, 1 MHz, 1 MHz, 1 MHz, 1 MHz, 1 MHz ON, ON, ON, ON, ON, ON
State Saved	Saved in instrument state.
Min	1 Hz
Max	50 MHz
Backwards Compatibility SCPI	[:SENSE]:ACPower:OFFSet[1] 2:LIST:BWIDth:VIDeo
Initial S/W Revision	Prior to A.02.00
Modified at S/W Revision	A.02.00, A.03.00
Help Map ID	7032

RBW Control

Accesses the resolution bandwidth control menu.

Key Path	Meas Setup, Offset/Limits, Offset BW
Initial S/W Revision	Prior to A.02.00
Help Map ID	7089

Filter Type

Selects the type of bandwidth filter that is used.

Key Path	Meas Setup, Offset/Limits, Offset BW, RBW Control
Mode	WCDMA, C2K, WIMAX OFDMA, TD-SCDMA, 1xEVDO, LTE, LTETDD

ACP Measurement
Meas Setup

Remote Command	<code>[:SENSe] :ACPower:OFFSet [1] 2:LIST:BANDwidth:SHAPE GAUSSian FLATtop, GAUSSian FLATtop, GAUSSian FLATtop, GAUSSian FLATtop, GAUSSian FLATtop, GAUSSian FLATtop</code> <code>[:SENSe] :ACPower:OFFSet [1] 2:LIST:BANDwidth:SHAPE?</code>
Example	ACP:OFFS2:LIST:BAND:SHAP FLAT,GAUS,GAUS,GAUS,GAUS,GAUS ACP:OFFS2:LIST:BAND:SHAP?
Notes	Offset sub op code. 1 for BTS, 2 for MS. Default is BTS. You must be in the mode that includes ACP measurements to use this command. Use :INSTrument:SElect to set the mode.
Couplings	See the description above
Preset	GAUSSian, GAUSSian, GAUSSian, GAUSSian, GAUSSian, GAUSSian
State Saved	Saved in instrument state.
Range	GAUSSian FLATtop
Backwards Compatibility SCPI	<code>[:SENSe]:ACPower:OFFSet[1] 2:LIST:BWIDth:SHAPE</code>
Initial S/W Revision	Prior to A.02.00
Modified at S/W Revision	A.02.00, A.03.00
Help Map ID	7033

Filter BW

Selects a Gaussian filter based on its –3 dB (Normal) bandwidth or its –6 dB bandwidth.

Key Path	Meas Setup, Offset/Limits, Offset BW, RBW Control
Mode	WCDMA, C2K, WIMAX OFDMA, TD-SCDMA, 1xEVDO, LTE, LTETDD
Remote Command	<code>[:SENSe] :ACPower:OFFSet [1] 2:LIST:BANDwidth:TYPE DB3 DB6, DB3 DB6, DB3 DB6, DB3 DB6, DB3 DB6, DB3 DB6</code> <code>[:SENSe] :ACPower:OFFSet [1] 2:LIST:BANDwidth:TYPE?</code>
Example	ACP:OFFS2:LIST:BAND:TYPE DB3,DB3,DB3,DB3,DB3,DB3 ACP:OFFS2:LIST:BAND:TYPE?
Notes	Offset sub op code. 1 for BTS, 2 for MS. Default is BTS. You must be in the mode that includes ACP measurements to use this command. Use :INSTrument:SElect to set the mode.
Dependencies	Grayed out unless the Gaussian filter type is selected
Preset	DB3, DB3, DB3, DB3, DB3, DB3
State Saved	Saved in instrument state.
Range	–3 dB (Normal) –6 dB
Backwards Compatibility SCPI	<code>[:SENSe]:ACPower:OFFSet[1] 2:LIST:BWIDth:TYPE</code>

Initial S/W Revision	Prior to A.02.00
Modified at S/W Revision	A.02.00, A.03.00
Help Map ID	7034

Limits

Limits key accesses a menu of functions that contains Select Offset, Abs Limit, Rel Limit and Fail Mask parameters.

Key Path	Meas Setup, Offset/Limits
Initial S/W Revision	A.03.00
Help Map ID	7106

Abs Limit

Enters an absolute limit value, which sets the absolute amplitude levels to test against for each of the custom offsets. The list must contain six (6) entries. If there is more than one offset, the offset closest to the carrier channel is the first one in the list. [:SENSe]:ACP:OFFSet[n]:LIST:TEST selects the type of testing to be done at each offset.

You can turn off (not use) specific offsets with the [:SENSe]:ACP:OFFSet[n]:LIST:STATe command.

The query returns the six (6) sets of real numbers that are the current absolute amplitude test limits.

Key Path	Meas Setup, Offset/Limits, Limits
Mode	WCDMA, C2K, WIMAX OFDMA, TD-SCDMA, 1xEVDO, LTE, LTETDD
Remote Command	[:SENSe]:ACPower:OFFSet [1] 2:LIST:ABSolute <real>, <real>, <real>, <real>, <real> [:SENSe]:ACPower:OFFSet [1] 2:LIST:ABSolute?
Example	ACP:OFFS2:LIST:ABS -10,-10,-10,-10,-10,-10 ACP:OFFS2:LIST:ABS?
Notes	Offset sub op code. 1 for BTS, 2 for MS. Default is BTS. You must be in the mode that includes ACP measurements to use this command. Use :INSTrument:SElect to set the mode.
Couplings	None

ACP Measurement
Meas Setup

Preset	WCDMA: 50 dBm, 50 dBm, 50 dBm, 50 dBm, 50 dBm, 50 dBm 50 dBm, 50 dBm, 50 dBm, 50 dBm, 50 dBm, 50 dBm C2K: 50 dBm, 50 dBm, 50 dBm, 50 dBm, 50 dBm, 50 dBm 50 dBm, 50 dBm, 50 dBm, 50 dBm, 50 dBm, 50 dBm 1xEVDO: -27 dBm, -27 dBm, -13 dBm, -13 dBm, -13 dBm, -13 dBm -27 dBm, -27 dBm, -13 dBm, -13 dBm, -13 dBm, -13 dBm LTE: -8.45, -8.45, -8.45, -8.45, -8.45, -8.45 -50.0, -50.0, -50.0, -50.0, -50.0, -50.0
State Saved	Saved in instrument state.
Min	-200.0 dBm
Max	50.0 dBm
Initial S/W Revision	Prior to A.02.00
Modified at S/W Revision	A.02.00, A.03.00
Help Map ID	7035

Rel Lim (Car)

Enters a relative limit value for the carrier level. This sets the amplitude levels to test against for the specified offsets.

The amplitude level is relative to the carrier amplitude. If multiple offsets are available, the list contains six (6) entries. The offset closest to the carrier channel is the first one in the list.

`[:SENSe]:ACP:OFFSet:LIST:TEST` selects the type of testing to be done at each offset.

`[:SENSe]:ACP:OFFSet[n]:LIST[n]:TEST` selects the type of testing to be done at each offset.

You can turn off (not use) specific offsets with the `[:SENSe]:ACP:OFFSet[n]:LIST[n]:STATe` command.

The query returns the six (6) sets of real numbers that are the current amplitude test limits, relative to the carrier, for each offset.

Offset[n] n = 1 is base station and n = 2 is mobiles. The default is base station (1).

Key Path	Meas Setup, Offset/Limits, Limits,
Mode	WCDMA, C2K, 1xEVDO, LTE
Remote Command	<code>[:SENSe]:ACP:Power:OFFSet [1] 2:LIST:RCARrier <real>, <real>, <real>, <real>, <real></code> <code>[:SENSe]:ACP:Power:OFFSet [1] 2:LIST:RCARrier?</code>
Example	<code>ACP:OFFS2:LIST:RCAR 0,0,0,0,0</code> <code>ACP:OFFS2:LIST:RCAR?</code>
Notes	Offset sub op code. 1 for BTS, 2 for MS. Default is BTS. You must be in the mode that includes ACP measurements to use this command. Use <code>:INSTrument:SELEct</code> to set the mode.

Couplings	None
Preset	WCDMA: -44.2, -49.2, -49.2, -49.2, -49.2, -49.2 -32.2, -42.2, -42.2, -42.2, -42.2, -42.2 C2K: 0, 0, 0, 0, 0, 0 0, 0, 0, 0, 0, 0 1xEVDO: -45, -55, -55, -55, -55, -55 -45, -55, -55, -55, -55, -55 LTE: -44.2, -44.2, -44.2, -44.2, -44.2, -44.2 -29.2, -29.2, -29.2, -29.2, -29.2, -29.2
State Saved	Saved in instrument state.
Min	-150
Max	50.0
Backwards Compatibility SCPI	[:SENSe]:MCPower:OFFSet[1] 2:LIST:RCARrier (PSA WCDMA)
Initial S/W Revision	Prior to A.02.00
Modified at S/W Revision	A.02.00, A.03.00, A.04.00
Help Map ID	7037

Positive Offset Limit

Enables you to set the upper limit for the upper segment of the specified offset pair.

Mode	WCDMA, C2K, WIMAX OFDMA, TD-SCDMA, 1xEVDO, LTE, LTETDD
Remote Command	:CALCulate:ACPpower:OFFSet:LIST:LIMit:POSitive[:UPPer]:DATA <real>, <real>, <real>, <real>, <real>, <real> :CALCulate:ACPpower:OFFSet:LIST:LIMit:POSitive[:UPPer]:DATA?
Example	CALC:ACP:OFFS:LIST:LIM:POS:DATA 0,0,0,0,0 CALC:ACP:OFFS:LIST:LIM:POS:DATA?
Notes	SCPI only command
Preset	WCDMA: -44.2, -49.2, -49.2, -49.2, -49.2, -49.2 -32.2, -42.2, -42.2, -42.2, -42.2, -42.2 C2K: 0, 0, 0, 0, 0, 0 0, 0, 0, 0, 0, 0 1xEVDO: -45, -55, -55, -55, -55, -55 -45, -55, -55, -55, -55, -55
State Saved	Saved in instrument state.
Min	-150.0
Max	50.0
Backwards Compatibility SCPI	:CALCulate:MCPower:OFFSet:LIST:LIMit:POSitive[:UPPer]:DATA (PSA Power Suite)
Initial S/W Revision	A.04.00

Help Map ID	0
-------------	---

Negative Offset Limit

Enables you to set the upper limit for the lower segment of the specified offset pair.

Mode	WCDMA, C2K, 1xEVDO, LTE
Remote Command	:CALCulate:ACPower:OFFSet:LIST:LIMit:NEGative[:UPPer]:DATA <real>, <real>, <real>, <real>, <real>, <real> :CALCulate:ACPower:OFFSet:LIST:LIMit:NEGative[:UPPer]:DATA?
Example	CALC:ACP:OFFS:LIST:LIM:NEG:DATA 0,0,0,0,0 CALC:ACP:OFFS:LIST:LIM:NEG:DATA?
Notes	SCPI only command
Preset	WCDMA: -44.2, -49.2, -49.2, -49.2, -49.2, -49.2 -32.2, -42.2, -42.2, -42.2, -42.2, -42.2 C2K: 0, 0, 0, 0, 0, 0 0, 0, 0, 0, 0, 0 1xEVDO: -45, -55, -55, -55, -55, -55 -45, -55, -55, -55, -55, -55
State Saved	Saved in instrument state.
Min	-150.0
Max	50.0
Backwards Compatibility SCPI	:CALCulate:MCPower:OFFSet:LIST:LIMit:NEGative[:UPPer]:DATA (PSA Power Suite)
Initial S/W Revision	A.04.00
Help Map ID	0

Rel Lim (PSD)

Enters a relative limit value for the level of the power spectral density. This sets the amplitude levels to test against for any custom offsets. The amplitude level is relative to the power spectral density. If multiple offsets are available, the list contains six (6) entries. The offset closest to the carrier channel is the first one in the list.

[[:SENSE]:ACP:OFFSet[n]:LIST[n]:TEST selects the type of testing to be done at each offset.

You can turn off (not use) specific offsets with the [[:SENSE]:ACP:OFFSet[n]:LIST:STATe command.

The query returns the six (6) sets of real numbers that are the current amplitude test limits, relative to the power spectral density, for each offset.

Offset[n] n = 1 is base station and n = 2 is mobiles. The default is base station (1).

Key Path	Meas Setup, Offset/Limits, Limits
Mode	WCDMA, C2K, 1xEVDO, LTE

Remote Command	[:SENSE]:ACPower:OFFSet [1] 2:LIST:RPSDensity <rel_ampl>, <rel_ampl>, <rel_ampl>, <rel_ampl>, <rel_ampl>, <rel_ampl> [:SENSE]:ACPower:OFFSet [1] 2:LIST:RPSDensity?
Example	ACP:OFFS2:LIST:RPSD 10,10,10,10,10,10 ACP:OFFS2:LIST:RPSD?
Notes	Offset sub op code. 1 for BTS, 2 for MS. Default is BTS. You must be in the mode that includes ACP measurements to use this command. Use :INSTrument:SElect to set the mode.
Preset	WCDMA: -44.2 dB, -49.2 dB, -49.2 dB, -49.2 dB, -49.2 dB, -49.2 dB -32.2 dB, -42.2 dB, -42.2 dB, -42.2 dB, -42.2 dB, -42.2 dB C2K: 0 dB, 0 dB, 0 dB, 0 dB, 0 dB, 0 dB 0 dB, 0 dB, 0 dB, 0 dB, 0 dB, 0 dB 1xEVDO: -45, -55, -55, -55, -55, -55 -45, -55, -55, -55, -55, -55 LTE: 0, 0, 0, 0, 0, 0 0, 0, 0, 0, 0, 0
State Saved	Saved in instrument state.
Min	-150.0 dB
Max	50.0 dB
Initial S/W Revision	Prior to A.02.00
Modified at S/W Revision	A.02.00, A.03.00
Help Map ID	7038

Fail Mask

Accesses a menu that enables you to select one of the logic keys for the fail conditions between the measurement results and the test limits. The setting defines the type of testing to be done at any custom offset frequencies. The measured powers are tested against the absolute values defined with [:SENSE]:ACP:OFFSet[n]:LIST:ABSolute, or the relative values defined with [:SENSE]:ACP:OFFSet:LIST:RPSDensity and [:SENSE]:ACP:OFFSet:LIST:RCARrier.

You can turn off (not use) specific offsets with the [:SENS]:ACP:OFFSet:LIST:STATe command.

- Absolute – Fail is shown if one of the absolute ACP measurement results is larger than the limit for Abs Limit.
- Relative – Fail is shown if one of the relative ACP measurement results is larger than the limit for Rel Lim (Car) or Rel Lim (PSD).
- Abs AND Rel – Fail is shown if one of the absolute ACP measurement results is larger than the limit for Abs Limit AND one of the relative ACP measurement results is larger than the limit for Rel Lim (Car) or Rel Lim (PSD).
- Abs OR Rel – Fail is shown if one of the absolute ACP measurement results is larger than the limit for Abs Limit OR one of the relative ACP measurement results is larger than the limit for Rel Lim (Car)

ACP Measurement
Meas Setup

or Rel Lim (PSD).

Key Path	Meas Setup, Offset/Limits, Limits
Mode	WCDMA, C2K, 1xEVDO, LTE
Remote Command	[:SENSe] :ACPpower:OFFSet [1] 2:LIST:TEST ABSolute AND OR RELative, ABSolute AND OR RELative, ABSolute AND OR RELative, ABSolute AND OR RELative, ABSolute AND OR RELative, ABSolute AND OR RELative [:SENSe] :ACPpower:OFFSet [1] 2:LIST:TEST?
Example	ACP:OFFS2:LIST:TEST ABS,ABS,ABS,ABS,ABS,ABS ACP:OFFS2:LIST:TEST?
Notes	Offset sub op code. 1 for BTS, 2 for MS. Default is BTS. You must be in the mode that includes ACP measurements to use this command. Use :INSTrument:SELect to set the mode.
Preset	WCDMA, C2K: REL, REL, REL, REL, REL, REL REL, REL, REL, REL, REL, REL CDMA1xEVDO: REL, REL, ABS, REL, REL, REL REL, REL, ABS, REL, REL, REL LTE: AND, AND, AND, AND, AND, AND AND, AND, AND, AND, AND, AND
State Saved	Saved in instrument state.
Range	Absolute Relative Abs AND Rel (fail if both fail) Abs OR Rel (fail if either fails)
Backwards Compatibility SCPI	[:SENSe] :MCPower:OFFSet[1] 2:LIST:TEST
Initial S/W Revision	Prior to A.02.00
Modified at S/W Revision	A.02.00, A.03.00, A.04.00
Modified at S/W Revision	A.04.00
Help Map ID	7036

Offset Side

Enables you to turn off (not use) specific offsets.

- NEGative - negative (lower) sideband only
- BOTH - both of the negative (lower) and positive (upper) sidebands
- POSitive - positive (upper) sideband only

Key Path	Meas Setup, Offset/Limits
Mode	WCDMA, C2K, 1xEVDO, LTE

Remote Command	[:SENSE] :ACPower:OFFSet [1] 2:LIST:SIDE NEGative BOTH POSitive,NEGative BOTH POSitive,NEGative BOTH POSitive,NEGative BOTH POSitive,NEGative BOTH POSitive,NEGative BOTH POSitive [:SENSE] :ACPower:OFFSet [1] 2:LIST:SIDE?
Example	ACP:OFFS:LIST:SIDE BOTH ACP:OFFS:LIST:SIDE?
Notes	OFFSet1 is for BTS, 2 for MS. Default is BTS. You must be in the W-CDMA mode, cdma2000 mode, 1xEVDO mode or LTE mode to use this command. Use :INSTrument:SElect to set the mode. If you set POS or NEG in an offset, result of the inactive side will return -999.
Preset	BOTH, BOTH, BOTH, BOTH, BOTH, BOTH BOTH, BOTH, BOTH, BOTH, BOTH, BOTH
State Saved	Saved in instrument state.
Range	Neg Both Pos
Initial S/W Revision	A.03.00
Help Map ID	7107

Method for Offset

This key allows you to turn RRC filtering of each offset on or off. The value (roll off) for the filter will be set to the value of the Filter Alpha parameter.

Key Path	Meas Setup, Offset/Limits
Mode	WCDMA, LTE
Remote Command	[:SENSE] :ACPower:OFFSet [1] 2:LIST:FILTer [:RRC] [:STATe] ON OFF 1 0, ON OFF 1 0, ON OFF 1 0, ON OFF 1 0, ON OFF 1 0, ON OFF 1 0 [:SENSE] :ACPower:OFFSet [1] 2:LIST:FILTer [:RRC] [:STATe] ?
Example	ACP:OFFS:LIST:FILT 1,0,0 ACP:OFFS:LIST:FILT?
Notes	1 ON = RRC Weighted, 0 OFF = Integ BW This parameter is not available for cdma2000 and 1xEVDO. You must be in the mode that includes ACP measurements to use this command. Use :INSTrument:SElect to set the mode.
Preset	WCDMA: 1, 1, 1, 1, 1, 1 1, 1, 1, 1, 1, 1 C2K: NO LTE: 0, 0, 0, 0, 0, 0 0, 0, 0, 0, 0, 0

ACP Measurement
Meas Setup

State Saved	Saved in instrument state.
Range	Integ BW RRC Weighted
Initial S/W Revision	A.03.00
Help Map ID	7108

Filter Alpha for Offset

Sets the alpha value for the RRC Filter for each offset.

Key Path	Meas Setup, Offset/Limits, Method, RRC Weighted
Mode	WCDMA, LTE
Remote Command	[:SENSe] :ACPpower:OFFSet [1] 2:LIST:FILTer:ALPHa <real>, <real>, <real>, <real>, <real> [:SENSe] :ACPpower:OFFSet [1] 2:LIST:FILTer:ALPHa?
Example	ACP:OFFS:LIST:FILT:ALPH 0.5,0.5,0.5,0.5,0.5,0.5 ACP:OFFS:LIST:FILT:ALPH?
Notes	This parameter is not available for cdma2000 and 1xEVDO. You must be in the mode that includes ACP measurements to use this command. Use :INSTrument:SElect to set the mode.
Preset	WCDMA: 0.22,0.22,0.22,0.22,0.22,0.22 0.22,0.22,0.22,0.22,0.22,0.22 C2K: NO LTE: 0.22,0.22,0.22,0.22,0.22,0.22 0.22,0.22,0.22,0.22,0.22,0.22
State Saved	Saved in instrument state.
Min	0.01
Max	1.00
Initial S/W Revision	A.03.00
Help Map ID	7109

Offset Frequency Define

This key allows you to select “Offset” definition. Each standard defines each “Offset” from Carrier.

3GPP2 requires the “From Carrier Center to MeasBW Closer Edge” definition. And LTE conformance test requires “From Carrier Edge to MeasBW Center” and/or “From Carrier Edge to MeasBW Closer Edge” definition.

- CTOCenter – From the center of the carrier closest to the adjacent channel to the center of the adjacent channel Offset Integ BW
- CTOEdge - From the center of the carrier closest to the adjacent channel to the edge of the closest adjacent channel Offset Integ BW

- ETOCenter – From Center Frequency - Carrier Spacing / 2 (for lower offset), Center Frequency + Carrier Spacing / 2 (for upper offset) of the carrier closest to the adjacent channel's to the center of the adjacent channel Offset Integ BW
- ETOEdge - From Center Frequency - Carrier Spacing / 2 (for lower offset), Center Frequency + Carrier Spacing / 2 (for upper offset) of the carrier closest to the adjacent channel's to the edge of the closest adjacent channel Offset Integ BW

Key Path	Meas Setup, Offset/Limits
Mode	WCDMA, C2K, 1xEVDO, LTE
Remote Command	[:SENSE] :ACPower:OFFSet [1] 2 :TYPE CTOCenter CTOEdge ETOCenter ETOEdge [:SENSE] :ACPower:OFFSet [1] 2 :TYPE?
Example	ACP:OFFS:TYPE ETOC ACP:OFFS:TYPE?
Notes	You must be in the mode that includes ACP measurements to use this command. Use :INSTrument:SElect to set the mode.
Preset	CTOCenter
State Saved	Saved in instrument state.
Range	Carrier Center To Meas BW Center Carrier Center To Meas BW Edge Carrier Edge To Meas BW Center Carrier Edge To Meas BW Edge
Initial S/W Revision	A.03.00
Help Map ID	7110

Carrier Result

Allows you to view and scroll through the carrier power results.

Key Path	Meas Setup
Mode	WCDMA, C2K, 1xEVDO, LTE
Couplings	This key will be grayed out if there is only one carrier.
Preset	1
State Saved	No
Min	1
Max	Number of carriers.
Initial S/W Revision	Prior to A.02.00
Modified at S/W Revision	A.02.00, A.03.00
Help Map ID	7039

PhNoise Opt

Selects the LO (local oscillator) phase noise behavior for various operating conditions.

Key Path	Meas Setup
Initial S/W Revision	Prior to A.02.00
Help Map ID	7055

PhNoise Opt Auto

Selects the best LO (local oscillator) phase noise behavior for the ACP measurement.

Auto works as follows:

Looks at all the offsets that are turned on.

Finds the largest and the smallest of the Freq Offset parameters for those offsets.

Takes the mean.

Compares that mean with the crossover frequency for the LO in use (see below).

If the mean is below the crossover frequency, use "best close-in," otherwise use "best wide-offset."

Key Path	Meas Setup
Mode	WCDMA, C2K, 1xEVDO, LTE
Remote Command	[:SENSe] :ACPower:FREQuency:SYNThesis:AUTO [:STATe] OFF ON 0 1 [:SENSe]:ACPower:FREQuency:SYNThesis:AUTO[:STATe]?
Example	ACP:FREQ:SYNT:AUTO 1 ACP:FREQ:SYNT:AUTO?
Preset	ON
State Saved	Saved in instrument state.
Range	Auto Man
Readback Text	"Auto" is underlined when Auto is selected, otherwise the Man is underlined.
Initial S/W Revision	Prior to A.02.00
Modified at S/W Revision	A.02.00, A.03.00, A.04.00
Help Map ID	7053

PhNoise Opt State

Selects the LO (local oscillator) phase noise behavior for various operating conditions.

Key Path	Meas Setup
----------	------------

Mode	WCDMA, C2K, 1xEVDO, LTE
Remote Command	[:SENSe] :ACPower:FREQuency:SYNThesis[:STATe] 1 2 3 [:SENSe] :ACPower:FREQuency:SYNThesis[:STATe] ?
Example	ACP:FREQ:SYNT 1 ACP:FREQ:SYNT?
Notes	Parameter key: 1 - optimizes phase noise for close-in from the carrier. 2 - optimizes phase noise for wide-offset from the carrier. 3 - optimizes LO for tuning speed.
Preset	Because this function is in Auto after preset, the state of this function after Preset will be automatically calculated.
State Saved	Saved in instrument state.
Range	Hardware dependent:
Readback Text	Close-in Wide-offset Fast Tuning, also the Man must be underlined.
Initial S/W Revision	Prior to A.02.00
Modified at S/W Revision	A.02.00, A.03.00 A.04.00
Help Map ID	7054

Meas Method

Sets the desired method to measure ACP.

Integration BW — one sweep of the trace is taken, and the band power for each offset is computed. Depending on the status of the Meas Type parameter (Total Power Reference or PSD Reference), results are displayed relative to the total power or the power spectral density. The display reflects either the current trace or a bar graph view.

Filtered IBW (max dynamic range) — the ACP Path is used to compute ACP when an ACP path is available. This method increases dynamic range, but increases measurement time as it limits the resolution bandwidth. This method is useful for improving dynamic range on a W-CDMA signal because a sharp cutoff bandpass filter is used. The accuracy of the adjacent channel power ratio is not degraded by this method, but the absolute accuracy of both adjacent channel power and carrier power are degraded by up to about 0.5 dB.

RBW — the algorithm uses zero-span and an appropriate RBW setting to capture all of the power in the carrier channel and the offsets. The zero-span algorithm (RBW method) is slower than the IBW method, but greatly improves repeatability.

Fast (in WCDMA mode or SA mode with 3GPP WCDMA radio standard selected) — this provides the same method as the Integration BW method, but is optimized for speed to measure a W-CDMA signal.

Fast (in CDMA2K mode or SA mode with CDMA2K radio standard selected) – this provides faster

ACP Measurement
Meas Setup

measurement using the FFT method with a limited parameter flexibility. When this is selected, CDMA2K preset offsets are given and control of the following are grayed out: BW menu, Sweep/Control menu except Pause/Resume, Trace/Detector menu, Carrier Setup, Offset Limit, RRC Weighting, Filter Alpha, and Noise Correction keys in Meas Setup menu.

In the TD-SCDMA mode, only the Integration BW method is available. Therefore, the Meas Method key is not displayed in the TD-SCDMA mode.

Key Path	Meas Setup
Mode	WCDMA, C2K, 1xEVDO, LTE
Remote Command	[:SENSE] :ACPower:METHOD IBW IBWRange FAST RBW [:SENSE] :ACPower:METHOD?
Example	ACP:METH IBW ACP:METH?
Notes	CDMA1xEVDO mode only supports RBW and Integration BW method. C2K mode only supports RBW, Integration BW and FAST method. FAST mode is only supported for WCDMA and C2K signal. You must be in the WCDMA or C2K mode with 3GPP WCDMA or CDMA2K radio standard. Otherwise a setting conflict error message will be reported. Supporting FAST mode in C2K is available with the instrument version A.02.00 or later You must be in the mode that includes ACP measurements to use this command. Use :INSTrument:SELEct to set the mode.
Couplings	IBW (Range) restricts the Res BW available for making this measurement to 30 kHz. When selected, the Res BW is clipped to this value if required and an error number displayed.
Preset	LTE, LTETDD: IBW WCDMA: IBW C2K: RBW WIMAX OFDMA: IBW 1xEVDO: IBW
State Saved	Saved in instrument state.
Range	Integration BW Filtered IBW (max dynamic range) RBW Fast
Readback Text	IBW Filtered IBW RBW Fast
Backwards Compatibility SCPI	[:SENSE] :ACPR:SWEEp:TYPE [:SENSE] :MCPower:METHOD (PSA Power Suite)
Initial S/W Revision	Prior to A.02.00
Modified at S/W Revision	A.02.00, A.03.00

Help Map ID	7040
-------------	------

Meas Type

Changes the reference used for the measurement. This allows you to make absolute and relative power measurements of either total power or the power normalized to the measurement bandwidth.

Total Pwr Ref (TPR) sets the reference to the total carrier power. PSD Ref (PSDR) sets the reference to the power spectral density of the carrier.

Key Path	Meas Setup
Mode	WCDMA, C2K, 1xEVDO, LTE
Remote Command	[:SENSE] :ACPower:TYPE TPref PSDRef [:SENSE] :ACPower:TYPE?
Example	ACP:TYPE PSDR ACP:TYPE?
Initial S/W Revision	Prior to A.02.00
Notes	You must be in the mode that includes ACP measurements to use this command. Use :INSTrument:SElect to set the mode.
Preset	TPRef
State Saved	Saved in instrument state.
Range	Total Power Ref PSD Ref
Modified at S/W Revision	A.02.00
Modified at S/W Revision	A.03.00
Help Map ID	7041

PSD Ref

Sets the unit bandwidth for Power Spectral Density. The available units are dBm/Hz and dBm/MHz.

Key Path	Meas Setup
Mode	WCDMA, C2K, 1xEVDO, LTE
Remote Command	:UNIT:ACPower:POWer:PSD DBMHZ DBMMHZ :UNIT:ACPower:POWer:PSD?
Example	UNIT:ACP:POW:PSD DBMMHZ UNIT:ACP:POW:PSD?
Couplings	When the PSD unit is changed, the PSD reference result of the "MEAS READ FETCH:ACP[n]?" is also changed by the PSD unit basis (in either dBm/Hz or dBm/MHz).

ACP Measurement
Meas Setup

Preset	DBMHZ
State Saved	Saved in instrument state.
Range	dBm/Hz dBm/MHz
Initial S/W Revision	Prior to A.02.00
Modified at S/W Revision	A.02.00, A.03.00
Help Map ID	7049

Limit Test

Turns limit checking for each offset On or Off. The limits may be specified within the Offset menu, for each offset, both sides of the carrier. For results that fail the limit, a red F is appended. In the Combined view, the bar turns red.

Key Path	Meas Setup
Mode	WCDMA, C2K, 1xEVDO, LTE
Remote Command	:CALCulate:ACPower:LIMit:STATe OFF ON 0 1 :CALCulate:ACPower:LIMit:STATe?
Example	CALC:ACP:LIM:STAT OFF CALC:ACP:LIM:STAT?
Notes	You must be in the mode that includes ACP measurements to use this command. Use :INSTrument:SELEct to set the mode.
Preset	WCDMA: ON C2K: ON 1xEVDO: ON LTE: ON
State Saved	Saved in instrument state.
Range	On Off
Backwards Compatibility SCPI	[:SENSe]:MCPower:LIMit[:STATe] [:SENSe]:ACPower:LIMit[:STATe]
Initial S/W Revision	Prior to A.02.00
Modified at S/W Revision	A.02.00, A.03.00
Help Map ID	7042

Noise Correction

Sets the measurement noise floor correction function to On or Off. On enables measurement noise correction when the measured noise power in the reference channel or any offset is close to the noise floor of

the test set. Off turns these corrections off.

In test sets with the noise floor extensions option (option NFE) enabled, there are two ways to compensate for the test set noise floor: through the NFE and through this noise corrections key. The techniques and results are similar but not identical. NFE uses a model of the test set noise floor, adapted to the current conditions such as center frequency, RBW and ambient temperature. The parameters of this model are measured in the factory or field calibration in a highly averaged measurement. So they are consistent. However, because the model is imperfect, the corrections are imperfect. Using NFE is very convenient; the user need not wait for the ACP noise corrections calibration to occur. The ACP NC calibration, though, has advantages of being measured very recently, at the current ambient, and the exact center frequency, with no requirement that the model be perfect. So it will often (but not always) have slightly better dynamic range. If both ACP NC is turned on and NFE is turned on, the test set uses only the ACP NC. When ACP NC is turned off but NFE is on, NFE is used and performance should still be excellent.

Key Path	Meas Setup
Mode	WCDMA, C2K, 1xEVDO, LTE
Remote Command	[:SENSe] :ACPower:CORREction:NOISe [:AUTO] OFF ON 0 1 [:SENSe] :ACPower:CORREction:NOISe [:AUTO] ?
Example	ACP:CORR:NOIS OFF ACP:CORR:NOIS?
Notes	You must be in the mode that includes ACP measurements to use this command. Use :INSTrument:SELEct to set the mode.
Preset	0
State Saved	Saved in instrument state.
Range	On Off
Initial S/W Revision	Prior to A.02.00
Modified at S/W Revision	A.02.00, A.03.00, A.04.00
Help Map ID	7074

Meas Preset

Restores all the measurement parameters to their default values.

Key Path	Meas Setup
Mode	WCDMA, C2K, 1xEVDO, LTE
Remote Command	:CONFIgure:ACPower
Example	CONF:ACP
Notes	You must be in the mode that includes ACP measurements to use this command. Use :INSTrument:SELEct to set the mode.

ACP Measurement
Meas Setup

Couplings	Selecting Meas Preset will restore all measurement parameters to their default values.
Initial S/W Revision	Prior to A.02.00
Modified at S/W Revision	A.02.00, A.03.00
Help Map ID	7045

Offset RRC Weighting (Backward Compatibility SCPI)

Key Path	SCPI Only
Mode	WCDMA, LTE, LTETDD
Remote Command	[:SENSE] :ACPower:FILTer [:RRC] [:STATe] OFF ON 0 1 [:SENSE] :ACPower:FILTer [:RRC] [:STATe] ?
Example	ACP:FILT OFF ACP:FILT?
Initial S/W Revision	Prior to A.02.00
Notes	This parameter is not available for cdma2000 and 1xEVDO The backwards Compatibility SCPI command, [:SENSe] :ACPR:FILTer [:RRC] [:STATe], is provided to support same functionality as [:SENSe] :ACPr:FILTer [:RRC] [:STATe] (PSA W-CDMA, PSA cdma2000 and PSA 1xEVDO) due to ACPr node conflicts with ACPower node. You must be in the mode that includes ACP measurements to use this command. Use :INSTrument:SELEct to set the mode.
Couplings	This command is an alias to [:SENSe] :ACPower:OFFSet [1] [2] :LIST:FILTer [:RRC] [:STATe] Sending the commands to set values of all offsets for BS and MS, however, sending the query always return a value of BS Offset A.
Preset	WCDMA: ON
State Saved	Saved in instrument state.
Backwards Compatibility SCPI	[:SENSe] :ACPR:FILTer [:RRC] [:STATe] [:SENSe] :MCPower:FILTer [:RRC] [:STATe]
Modified at S/W Revision	A.03.00
Help Map ID	0

Offset Filter Alpha (Backward Compatibility SCPI)

Key Path	SCPI Only
Mode	WCDMA, LTE, LTETDD
Remote Command	[:SENSE] :ACPower:FILTer [:RRC] :ALPHA <real> [:SENSE] :ACPower:FILTer [:RRC] :ALPHA?
Example	ACP:FILT:ALPH 0.5 ACP:FILT:ALPH?

ACP Measurement
Meas Setup

Notes	<p>This parameter is not available for cdma2000 and 1xEVDO</p> <p>The backwards Compatibility SCPI command, [:SENSe]:ACPR:FILTer[:RRC]:ALPHa, is provided to support same functionality as [:SENSe]:ACPr:FILTer[:RRC]:ALPHa (PSA W-CDMA, PSA cdma2000 and PSA 1xEVDO) due to ACPr node conflicts with ACPower node.</p> <p>You must be in the mode that includes ACP measurements to use this command. Use :INSTrument:SELEct to set the mode.</p>
Couplings	<p>This command is an alias to</p> <p>[:SENSe]:ACPower:OFFSet[1]:2:LIST:FILTer:ALPhHa</p> <p>Sending the commands to set values of all offsets for BS and MS, however, sending the query always return a value of BS Offset A.</p>
Preset	<p>WCDMA, LTE, LTETDD: 0.22</p> <p>C2K: NO</p>
State Saved	Saved in instrument state.
Min	0.01
Max	1.00
Backwards Compatibility SCPI	<p>[:SENSe]:ACPR:FILTer[:RRC]:ALPHa</p> <p>[:SENSe]:MCPower:FILTer[:RRC]:ALPHa</p>
Initial S/W Revision	Prior to A.02.00
Modified at S/W Revision	A.02.00, A.03.00
Help Map ID	0

Method for Carrier (Backward Compatibility SCPI)

Key Path	SCPI Only
Mode	WCDMA, LTE, LTETDD
Remote Command	<p>[:SENSe]:ACPower:CARRier[1] 2:LIST:METHod IBW RRC, ...</p> <p>[:SENSe]:ACPower:CARRier[1] 2:LIST:METHod?</p>
Example	<p>ACP:CARR2:LIST:METH RRC</p> <p>ACP:CARR2:LIST:METH?</p>
Notes	<p>You must be in the mode that includes ACP measurements to use this command. Use :INSTrument:SELEct to set the mode.</p> <p>Maximum of Array length depends on the number of carriers.</p>

Couplings	<p>This command is an alias to [:SENSe]:ACPower:CARRier[1] 2:LIST:FILTer[:RRC][:STATe]</p> <p>The enum value translates as follows: RRC Weighted = 1 ON Integ BW = 0 OFF Maximum of Array length depends on the number of carriers.</p>
Preset	<p>WCDMA: RRC WIMAX OFDMA: IBW TD-SCDMA: RRC LTE, LTETDD: IBW LTETDD: IBW</p>
State Saved	Saved in instrument state.
Initial S/W Revision	Prior to A.02.00
Modified at S/W Revision	A.03.00
Help Map ID	0

Mode

See [Key and Command descriptions@2670@i](#) for more information.

Key Path	Front-panel key
Initial S/W Revision	Prior to A.02.00
Help Map ID	0

Mode Setup

See [Mode Setup@\(WCDMA\)4536, \(OFDMA\)20022, \(cdma2000\)26100, \(1xEVDO\)28100, \(TD-SCDMA\)4001, \(LTE\)28881, \(LTE TDD\)4001](#) for more information.

Key Path	Front-panel key
Initial S/W Revision	Prior to A.02.00
Help Map ID	0

Peak Search

Accesses a menu that enables you to control the peak search function.

Key Path	Front-panel key
Initial S/W Revision	Prior to A.02.00
Help Map ID	7097

Peak Search

Places the selected marker on the trace point with the maximum y-axis value.

Key Path	Peak Search
Mode	WCDMA, C2K, WIMAX OFDMA, TD-SCDMA, 1xEVDO, LTE, LTETDD
Remote Command	:CALCulate:ACPower:MARKer [1] 2 3 4 5 6 7 8 9 10 11 12 :M AXimum
Example	CALC:ACP:MARK2:MAX
Initial S/W Revision	Prior to A.02.00
Modified at S/W Revision	A.02.00, A.03.00
Help Map ID	7066

Next Peak

Moves the selected marker to the peak that has the next highest amplitude.

Key Path	Peak Search
Mode	WCDMA, C2K, WIMAX OFDMA, TD-SCDMA, 1xEVDO, LTE, LTETDD
Remote Command	:CALCulate:ACPower:MARKer [1] 2 3 4 5 6 7 8 9 10 11 12 :M AXimum:NEXT
Example	CALC:ACP:MARK2:MAX:NEXT
Initial S/W Revision	Prior to A.02.00
Modified at S/W Revision	A.02.00, A.03.00
Help Map ID	7067

Next Pk Right

Moves the selected marker to the nearest peak to the right of the current marker that meets all enabled

peak criteria.

Key Path	Peak Search
Mode	WCDMA, C2K, WIMAX OFDMA, TD-SCDMA, 1xEVDO, LTE, LTETDD
Remote Command	:CALCulate:ACPower:MARKer [1] 2 3 4 5 6 7 8 9 10 11 12 :MAXimum:RIGHT
Example	CALC:ACP:MARK2:MAX:RIGH
Initial S/W Revision	Prior to A.02.00
Modified at S/W Revision	A.02.00, A.03.00
Help Map ID	7070

Next Pk Left

Moves the selected marker to the nearest peak to the left of the current marker that meets all enabled peak criteria.

Key Path	Peak Search
Mode	WCDMA, C2K, WIMAX OFDMA, TD-SCDMA, 1xEVDO, LTE, LTETDD
Remote Command	:CALCulate:ACPower:MARKer [1] 2 3 4 5 6 7 8 9 10 11 12 :MAXimum:LEFT
Example	CALC:ACP:MARK2:MAX:LEFT
Initial S/W Revision	Prior to A.02.00
Modified at S/W Revision	A.02.00, A.03.00
Help Map ID	7069

Marker Delta

Sets the control mode for the selected marker to Delta mode.

See Marker Delta in the "Marker Functions" section for more information.

Key Path	Peak Search
Initial S/W Revision	Prior to A.02.00
Help Map ID	7098

Pk-Pk Search

Finds and displays the amplitude and frequency (or time, if in zero span) differences between the highest

ACP Measurement
Peak Search

and lowest y-axis value.

Key Path	Peak Search
Mode	WCDMA, C2K, WIMAX OFDMA, TD-SCDMA, 1xEVDO, LTE, LTETDD
Remote Command	:CALCulate:ACPower:MARKer [1] 2 3 4 5 6 7 8 9 10 11 12 :PTPeak
Example	CALC:ACP:MARK:PTP
Notes	Turns on the Marker Δ active function.
Couplings	This key is not available (key is grayed out) when Coupled Markers is on.
Initial S/W Revision	Prior to A.02.00
Modified at S/W Revision	A.02.00, A.03.00
Help Map ID	7072

Min Search

Moves the selected marker to the minimum y-axis value on the current trace.

Key Path	Peak Search
Mode	WCDMA, C2K, WIMAX OFDMA, TD-SCDMA, 1xEVDO, LTE, LTETDD
Remote Command	:CALCulate:ACPower:MARKer [1] 2 3 4 5 6 7 8 9 10 11 12 :MINimum
Example	CALC:ACP:MARK:MIN
Initial S/W Revision	Prior to A.02.00
Modified at S/W Revision	A.02.00, A.03.00
Help Map ID	7073

Recall

See [Recall@\(Key and Command descriptions\)2637, \(LTE\)28892, \(LTETDD\)40472, \(MSR\)45000](#) for more information.

Key Path	Front-panel key
Initial S/W Revision	Prior to A.02.00
Help Map ID	0

Restart

See Restart@3307@i for more information.

Key Path	Front-panel key
Initial S/W Revision	Prior to A.02.00
Help Map ID	0

Save

See [Key and Command Descriptions@2600@i](#) for more information.

Key Path	Front-panel key
Initial S/W Revision	Prior to A.02.00
Help Map ID	0

Single

See [Single \(Single Measurement/Sweep\)@3515@i](mailto:Single (Single Measurement/Sweep)@3515@i) for more information.

Key Path	Front-panel key
Initial S/W Revision	Prior to A.02.00
Help Map ID	0

Source (Internal)

See Source@35360@i for more information.

Key Path	Front-panel key
Initial S/W Revision	A.05.00
Help Map ID	0

SPAN X Scale

Accesses a menu of functions that enable you set the horizontal scale parameters.

Key Path	Front-panel key
Initial S/W Revision	Prior to A.02.00
Help Map ID	7076

Span

Changes the frequency range symmetrically about the center frequency.

The default (and minimum) span is calculated using the number of carriers and the carrier width where;

$$\text{Span} = (\text{Upper Carrier Freq} + (\text{max offset IBW} * (1 + \alpha)) / 2) - (\text{Lower Carrier Freq} - (\text{max offset IBW} * (1 + \alpha)) / 2)$$

The span is increased by a factor of 1 + Filter Alpha if the RRC Filter is on.

Key Path	SPAN X Scale
Mode	WCDMA, C2K, WIMAX OFDMA, TD-SCDMA, 1xEVDO, LTE, LTETDD
Remote Command	[:SENSe] :ACPower:FREQuency:SPAN <freq> [:SENSe] :ACPower:FREQuency:SPAN?
Example	ACP:FREQ:SPAN 25 MHz ACP:FREQ:SPAN?
Notes	You must be in the mode that includes ACP measurements to use this command. Use :INSTrument:SELEct to set the mode.
Couplings	The span value is clipped when the carrier settings and/or the offset settings are changed. The value is changed to satisfy following formula: Span = (Upper Carrier Freq + (max offset IBW * (1 + alpha)) / 2) - (Lower Carrier Freq - (max offset IBW * (1 + alpha)) / 2)
Preset	SA: 8 MHz WCDMA: 24.6848 MHz WIMAX OFDMA: 50 MHz C2K: 4.5 MHz TD-SCDMA: 8 MHz 1xEVDO: 4.05 MHz LTE, LTETDD: 15 MHz
State Saved	Saved in instrument state.

Min	10 Hz
Max	Hardware Dependent: Option 503 = 3.7 GHz Option 504 = 3.9 GHz
Initial S/W Revision	Prior to A.02.00
Modified at S/W Revision	A.03.00
Help Map ID	7000

Full Span

Changes the span to show the full frequency range of the test set.

Key Path	SPAN X Scale
Mode	WCDMA, C2K, WiMAX OFDMA, TD-SCDMA, 1xEVDO, LTE, LTETDD
Remote Command	[:SENSe] :ACPower :FREQuency :SPAN :FULL
Example	ACP:FREQ:SPAN:FULL
Notes	You must be in the mode that includes ACP measurements to use this command. Use :INSTrument:SElect to set the mode.
Initial S/W Revision	Prior to A.02.00
Modified at S/W Revision	A.02.00, A.03.00
Help Map ID	7001

Last Span

Changes the span to the previous span setting. If no previous span value exists, then the span will remain unchanged.

Key Path	SPAN X Scale
Mode	WCDMA, C2K, WIMAX OFDMA, TD-SCDMA, 1xEVDO, LTE, LTETDD
Remote Command	[:SENSe] :ACPower :FREQuency :SPAN :PREVIOUS
Example	ACP:FREQ:SPAN:PREV
Notes	You must be in the mode that includes ACP measurements to use this command. Use :INSTrument:SElect to set the mode.
Initial S/W Revision	Prior to A.02.00
Modified at S/W Revision	A.02.00, A.03.00
Help Map ID	7002

Sweep/Control

Accesses a menu of functions that enable you to set up and control the sweep time, and source.

See [Key and Command Descriptions – Sweep/Control@3273](#) for more information

Key Path	Front-panel key
Initial S/W Revision	Prior to A.02.00
Help Map ID	7091

Sweep Time

Selects the length of time in which the test set sweeps the displayed frequency span. In swept spans, the sweep time varies from 1 millisecond to 2000 seconds. Additional overhead time, which impacts the sweep rate, is not calculated as part of the sweep time. In fact:

sweep rate = span/sweep time

update rate = 1/(sweep time + overhead)

sweep cycle time = sweep time + overhead

Sweep time is coupled to RBW and VBW, and is impacted by the number of sweep points, so changing those parameters may change the sweep time.

If you increase the sweep time, you increase the length of the time data captured and the number of points measured. You might need to specify a specific sweep speed to accommodate a specific condition in your transmitter. For example, you may have a burst signal and need to measure an exact portion of the burst.

Selecting a specific sweep time may result in a long measurement time since the resulting number of data points may not be the optimum $2n$. Use `[:SENSE]:ACP:OFFSet:LIST:SWEep:TIME` to set the number of points used for measuring the offset channels for Basic and cdmaOne.

For cdma2000 and W-CDMA, this command sets the sweep time when using the sweep mode. See `[:SENSE]:ACP:SWEep:TYPE`

Key Path	Sweep/Control
Mode	WCDMA, C2K, WIMAX OFDMA, TD-SCDMA, 1xEVDO, LTE, LTETDD
Remote Command	<code>[:SENSE]:ACP:Power:SWEep:TIME <time></code> <code>[:SENSE]:ACP:Power:SWEep:TIME?</code> <code>[:SENSE]:ACP:Power:SWEep:TIME:AUTO OFF ON 0 1</code> <code>[:SENSE]:ACP:Power:SWEep:TIME:AUTO?</code>

Example	ACP:SWE:TIME 50ms ACP:SWE:TIME? ACP:SWE:TIME:AUTO OFF ACP:SWE:TIME:AUTO?
Notes	This parameter is preset by Meas Method selection. Preset values are as follows: IBW: 29 ms IBWR: 108 ms FAST (WCDMA): 7.5 ms
Couplings	When you manually change the Sweep Time, this state automatically goes to 'Man'.
Preset	LTE, LTETDD: Automatically calculated WCDMA: 29 ms WIMAX OFDMA: Automatically calculated C2K: Automatically calculated TD-SCDMA: Automatically calculated 1xEVDO: Automatically calculated LTE, LTETDD: ON WCDMA: OFF C2K: OFF (method IBW) WIMAX OFDMA: ON TD-SCDMA: ON
State Saved	Saved in instrument state.
Min	1 ms
Max	4000 s
Help Map ID	7047

Sweep Setup

Accesses the sweep setup menu.

Key Path	Sweep/Control
Initial S/W Revision	Prior to A.02.00
Help Map ID	7092

Auto Sweep Time Rules

Switches the test set between normal and accuracy sweep states.

Key Path	Sweep/Control, Sweep Setup
Mode	WCDMA, C2K, WIMAX OFDMA, TD-SCDMA, 1xEVDO, LTE, LTETDD
Remote Command	[:SENSE] :ACPower:SWEep:TIME:AUTO:RULEs NORMal ACCuracy [:SENSe] :ACPower:SWEep:TIME:AUTO:RULEs?
Example	ACP:SWE:TIME:AUTO:RUL NORM ACP:SWE:TIME:AUTO:RUL?
Notes	Set to Norm when Auto Couple is pressed or sent remotely.
Preset	WCDMA, C2K, TD-SCDMA, 1xEVDO, LTE, LTETDD: ACCuracy WIMAX OFDMA: NORMal
State Saved	Saved in instrument state.
Range	Norm Accy
Initial S/W Revision	Prior to A.02.00
Modified at S/W Revision	A.02.00, A.03.00
Help Map ID	7048

Pause

Pauses a measurement after the current data acquisition is complete. When Paused, the label on the key changes to Resume. Pressing the Resume key resumes the measurement at the point where it was paused. When Paused, pressing **Restart**, **Single**, or **Cont** does a Resume.

See [Pause/Resume@3290@i](#) for more details.

Key Path	Sweep/Control
Initial S/W Revision	Prior to A.02.00
Help Map ID	7093

Gate

Accesses a menu that enables you to control the gating function. The Gate functionality is used to view signals best viewed by qualifying them with other events.

Gate Method that lets you choose one of the three different types of gating is not available in this measurement.

See [Gate@3292](#) for more details.

Key Path	Sweep/Control
Initial S/W Revision	Prior to A.02.00
Help Map ID	Use 3292

Points

Sets the number of points per sweep, from 1 to 20001. The sweep time resolution setting will depend on the number of points selected.

Key Path	Sweep/Control
Mode	WCDMA, C2K, WIMAX OFDMA, 1xEVDO, LTE, LTETDD
Remote Command	[:SENSE] :ACPpower :SWEep:POINts <integer> [:SENSE] :ACPpower :SWEep:POINts?
Example	ACP:SWE:POIN 500 ACP:SWE:POIN?
Notes	Whenever the number of sweep points changes: <ul style="list-style-type: none"> • All trace data is erased • Any traces with Update Off will also go to Display Off (like going from View to Blank in the older test sets) • Sweep time is re-quantized • Any limit lines that are on will be updated • If averaging/hold is on, averaging/hold starts over
Couplings	Whenever the number of sweep points changes, the sweep time is re-quantized.
Preset	1001
State Saved	Saved in instrument state.
Min	1
Max	20001
Initial S/W Revision	Prior to A.02.00
Modified at S/W Revision	A.02.00, A.03.00
Help Map ID	7057

Trace/Detector

Accesses a menu of functions that enable you to control the detectors for the current measurement.

Key Path	Front-panel key
Initial S/W Revision	Prior to A.02.00
Help Map ID	7051

Select Trace (Front-panel Only)

This key selects which trace the other parameters under the Trace/Detector menu will apply to.

Key Path	Trace/Detector
Notes	Front panel only.
Couplings	When Meas Method is RBW or FAST, Select Trace is disabled.
Preset	1
State Saved	Saved in instrument state.
Range	1 2 3
Initial S/W Revision	Prior to A.02.00
Help Map ID	7046

Trace Type

Allows you to select the type of trace for the current measurement. The first page of this menu contains a selection of the trace type (Clear Write, Trace Average, Max Hold, Min Hold) for the selected trace.

Key Path	Trace/Detector
Mode	WCDMA, C2K, WIMAX OFDMA, TD-SCDMA, 1xEVDO, LTE, LTETDD
Remote Command	:TRACe [1] 2 3 :ACPoweR :TYPE WRITe AVERAge MAXHold MINHold :TRACe [1] 2 3 :ACPoweR :TYPE?
Example	TRAC:ACP:TYPE MINH TRAC:ACP:TYPE?
Notes	WRITe = Clear Write AVERAge = Average MAXHold = Maximum Hold MINHold = Minimum Hold

Couplings	<p>When Detector setting is “Auto” (:SENSe]:ACPower:DETEctor:AUTO?), Detector is set to what the Radio Standard defaults states (see detector section below) for all conditions of Trace Type and for all traces. When set to Manual, all Traces use the same detector type. When Average State = Off then Trace Types AVERAge, MaxHold and MinHold will not function, since Averaging is required to be ‘on’ for them to operate.</p> <p>When Meas Method is RBW or FAST, Trace Type is disabled.</p>
Preset	AVERAge
State Saved	Saved in instrument state.
Initial S/W Revision	Prior to A.02.00
Modified at S/W Revision	A.02.00, A.03.00
Help Map ID	7050

View / Blank

Key Path	Trace/Detector
Mode	WCDMA, C2K, WIMAX OFDMA, TD-SCDMA, 1xEVDO, LTE, LTETDD
Initial S/W Revision	Prior to A.02.00
Notes	No SCPI. Front panel only.
Couplings	<p>The four states of this 1-of-N actually set two variables, Update and Display, to their four possible combinations. Trace On: Update and Display both On</p> <p>View: Update Off and Display On (Not implemented)</p> <p>Blank: Update Off and Display Off</p> <p>Background: Update On, Display Off (Not implemented)</p> <p>See tables below for detail on the SCPI to control these two variables.</p> <p>Selecting a trace type (Clear Write, Trace Average, Max Hold, Min Hold) for a trace (pressing the key or sending the equivalent SCPI command) puts the trace in 'Trace On' state (Update On and Display On), even if that trace type was already selected.</p> <p>When Meas Method is RBW or FAST, this key is grayed out.</p>
Preset	Trace On
State Saved	Saved in instrument state.
Range	Trace On Blank
Modified at S/W Revision	A.03.00
Help Map ID	7056

Key Path	Trace/Detector
Mode	WCDMA, C2K, WIMAX OFDMA, TD-SCDMA, 1xEVDO, LTE, LTETDD
Remote Command	:TRACe [1] 2 3 :ACPower:UPDate [:STATe] ON OFF 0 1 :TRACe [1] 2 3 :ACPower:UPDate [:STATe] ?
Example	TRAC:ACP:UPD ON TRAC:ACP:UPD?
Couplings	<p>Whenever you set Update to On for any trace, the Display is set to On for that trace.</p> <p>When Meas Method is RBW or FAST, Trace Update is disabled.</p>
Preset	1 0 0 (On for Trace 1; Off for 2 &3)
State Saved	Saved in instrument state.
Range	0 1
Initial S/W Revision	Prior to A.02.00

Modified at S/W Revision	A.03.00
Help Map ID	0
Key Path	Trace/Detector
Mode	WCDMA, C2K, WIMAX OFDMA, TD-SCDMA, 1xEVDO, LTE, LTETDD
Remote Command	:TRACe [1] 2 3 :ACPpower:DISPlay [:STATe] ON OFF 0 1 :TRACe [1] 2 3 :ACPpower:DISPlay [:STATe] ?
Example	TRAC:ACP:DISP ON TRAC:ACP:DISP?
Couplings	Whenever you set Update to On for any trace, the Display is set to On for that trace. When Meas Method is RBW or FAST, Trace Display is disabled.
Preset	1 0 0 (On for Trace 1; Off for 2 &3)
State Saved	Saved in instrument state.
Range	0 1
Initial S/W Revision	Prior to A.02.00
Modified at S/W Revision	A.03.00
Help Map ID	0

Detector

Accesses a menu of functions that enables you to control the detectors for the current measurement. Allows up to three (3) traces, but each use the same detector type choice. The following choices are available:

- Auto- the detector selected is set to AVERage, unless the Radio Standard defaults state otherwise e.g. it is set to Peak for Radio Standard = PDC when Device = both MS and BTS, and when Radio Standard = NADC and Device = MS.
- Normal-the detector determines the peak of the CW-like signals, and it yields alternating maximums and minimums of noise-like signals. This is also referred to as Rosenfell detection.
- Average-the detector determines the average of the signal within the sweep points. The averaging method is Power (RMS).
- Peak-the detector determines the maximum of the signal within the sweep points.
- Sample-the detector indicates the instantaneous level of the signal at the center of the sweep points represented by each display point.
- Negative Peak-the detector determines the minimum of the signal within the sweep points.

In swept analysis, the time interval of the data collection for the display sweep points also represents a frequency interval. In FFT analysis, the sweep points represents just a frequency interval. The detector

ACP Measurement
Trace/Detector

determines the relationship between the spectrum computed by the FFT and the single data point displayed for the sweep points.

Key Path	Trace/Detector
Initial S/W Revision	Prior to A.02.00
Help Map ID	7052

Auto

Sets the detector for the currently selected trace to auto.

Key Path	Trace/Detector
Mode	WCDMA, C2K, WIMAX OFDMA, TD-SCDMA, 1xEVDO, LTE, LTETDD
Remote Command	[:SENSE] :ACPpower:DETECTOR:AUTO ON OFF 1 0 [:SENSE] :ACPpower:DETECTOR:AUTO?
Example	ACP:DET:AUTO 1 ACP:DET?
Couplings	When Detector setting is “Auto” ([:SENSE]:ACPpower:DETECTOR:AUTO?), Detector is set to what the Radio Standard defaults states (see detector section) for all conditions of Trace Type and for all traces. When set to Manual, all Traces use the same detector type. When Average State = Off then Trace Types AVERage, MaxHold and MinHold will not function, since Averaging is required to be ‘on’ for them to operate.
Preset	ON
State Saved	Saved in instrument state.
Range	ON OFF
Initial S/W Revision	Prior to A.02.00
Modified at S/W Revision	A.02.00, A.03.00
Help Map ID	7009

Detector Selection

Selects a detector to be used by the test set for the current measurement. All traces will use the same detector type, similar to Monitor Spectrum measurement

Key Path	Trace/Detector
Mode	WCDMA, C2K, WIMAX OFDMA, TD-SCDMA, 1xEVDO, LTE, LTETDD
Remote Command	[:SENSE] :ACPpower:DETECTOR [:FUNCTION] AVERage NEGative NORMal POSitive SAMPLE [:SENSE] :ACPpower:DETECTOR [:FUNCTION]?

Example	ACP:DET NORM ACP:DET?
Notes	<p>When you manually select a detector (instead of selecting Auto), that detector is used regardless of other test set settings.</p> <p>The detector choices are:</p> <ul style="list-style-type: none"> • The Normal detector determines the peak of CW-like signals, and it yields alternating maximums and minimums of noise-like signals. This is also referred to as Rosenfell detection. • The Average detector determines the average of the signal within the data range. The averaging method is Power (RMS). • The Peak detector determines the maximum of the signal within the data range. • The Sample detector indicates the instantaneous level of the signal at the center of the data represented by each display point. • The Negative Peak detector determines the minimum of the signal within the data range. <p>Because they may not find a spectral component's true peak, neither average nor sample detectors measure amplitudes of CW signals as accurately as peak or normal, but they do measure noise without the biases of peak detection.</p> <p>When a detector selection is made, the menu returns to the previous menu.</p>
Couplings	<p>When Detector setting is "Auto" (:SENSE]:ACPower:DETECTOR:AUTO?), Detector is set to what the Radio Standard defaults states (see detector section) for all conditions of Trace Type and for all traces. When set to Manual, all Traces use the same detector type. When Average State = Off then Trace Types AVERAGE, MaxHold and MinHold will not function, since Averaging is required to be 'on' for them to operate.</p> <p>Only one detector type for all 3 traces is allowed.</p> <p>When Meas Method is RBW or FAST, Detector is disabled.</p>
Preset	AVERAGE
State Saved	Saved in instrument state.
Range	Normal Average Peak Sample Negative Peak
Backwards Compatibility SCPI	[:SENSE]:ACPR:SWEep:DETECTOR[:FUNCTION]
Initial S/W Revision	Prior to A.02.00
Modified at S/W Revision	A.02.00, A.03.00
Help Map ID	7008

Trigger

Accesses a menu functions that enable you to select and control the trigger source for the current measurement. See Trigger@3371@i for more information.

Key Path	Front-panel key
Initial S/W Revision	Prior to A.02.00
Help Map ID	7090

View/Display

Accesses a menu of functions that enable you to control the instrument display as well as turn the bar graph On and Off.

The display consists of the following two windows:

“Spectrum Window” on page 549

“Results Window” on page 549

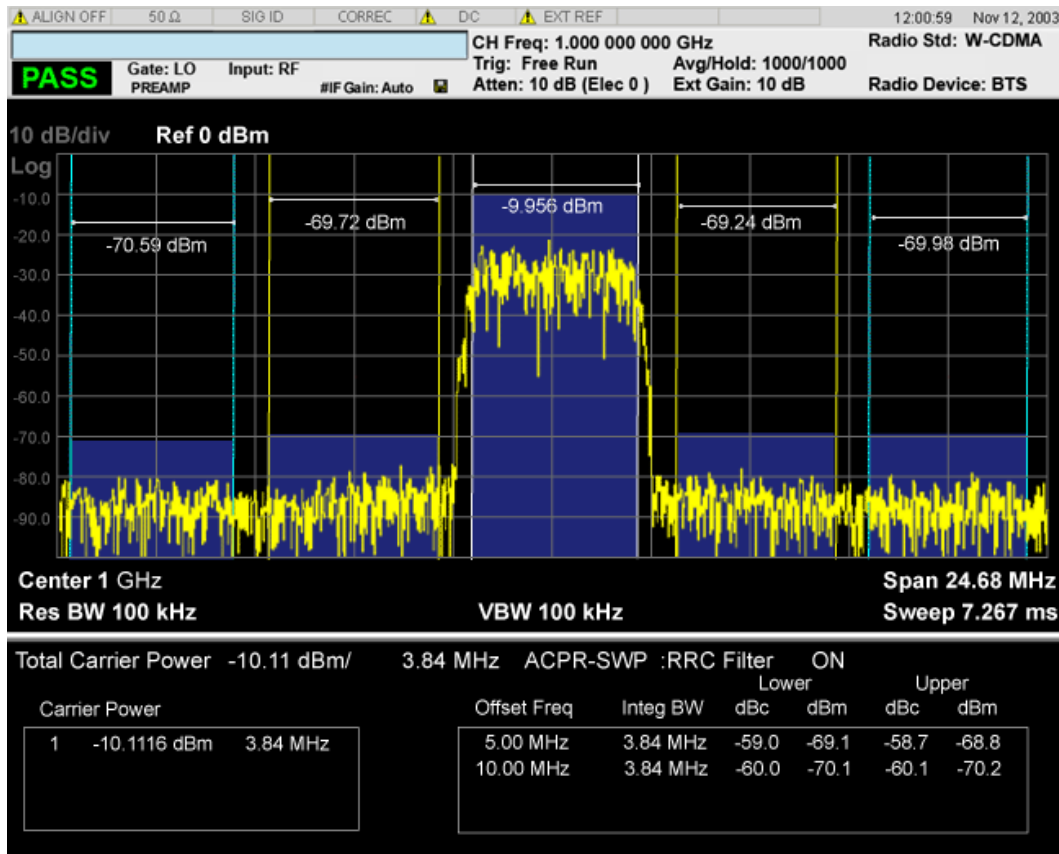

Spectrum Window

When the Bar Graph is On and Limit Test is On, the color of each bar graph reflects the limit test result. When the limit test fails, the bar color is red, and when limit test passes, the bar color is blue.

When RBW is selected as the measurement method, the spectrum trace is not displayed, only the bar graph is displayed. In addition, the Bar Graph key (under the View/Display front-panel key) is set to ON and is grayed out.

The RRC Filter display item is only displayed when RRC filter is on.

Results Window

The text window displays the following results:

Total Carrier Power

This is the total power of all the carriers with carrier power present set to yes. The power is calculated by integrating across the bandwidth declared by the Carrier Integ Bw parameter for each carrier and then totaling the sums. The total integration bandwidth is shown as part of the result. This will be the total of the Carrier Integ Bw of the carriers used in calculating the total carrier power. If the RRC Filter is on, then the integration bandwidth used is $(1 + \alpha)/T$ where $T = 1/(\text{Carrier Integ Bw})$ multiplied by the number of carriers with carrier power present set to yes.

Ref Carrier Power

This is the power in the reference carrier. The power is calculated by integrating across the bandwidth declared by the Carrier Integ Bw parameter for that carrier. The integration bandwidth is shown as part of the result. This is the value of the Carrier Integ Bw for that carrier unless the RRC Filter is on, then the integration bandwidth used is the displayed value, which is $(1 + \alpha)/T$ where $T = 1/(\text{Carrier Integ Bw})$.

Carrier Power

This is the power in all the currently defined carriers. If the carrier has carrier power present, the power will be absolute. If the carrier is defined as not having power present, the power will be relative to the reference carrier. The power is calculated by integrating across the bandwidth declared by the Carrier Integ Bw parameter. The integration bandwidth is shown as part of the result. This is the value of the Carrier Integ Bw for the carrier unless the RRC Filter is on, then the integration bandwidth used is the displayed value, which is $(1 + \alpha)/T$ where $T = 1/(\text{Carrier Integ Bw})$.

As there are potentially more results than can be easily viewed on the display, a scrollable list is used to display all results. The Carrier Results menu key is used to index the carrier amplitude results. This key is grayed out unless the measurement is in single mode (as in continual measurement mode). The display is continuously updating and will not need to be accessed. The currently selected Carrier Result is displayed on the last line of the carrier power result list unless:

- The selected Carrier Result is 4 or less in normal multi carrier power results view. In this case the first 4 carrier power results will be displayed.
- The selected Carrier Result is 9 or greater in normal multi carrier power results view. In this case the last 4 carrier power results will be displayed.
- The zoom mode is selected. In this case all carrier power ranges can be displayed.

Offset Relative Power

This is the power in the offsets relative to the reference carrier. The power is calculated by integrating across the bandwidth declared by the Offset Integ Bw parameter. The offset integration bandwidth is shown as part of the result. This is the value on the Offset Integ Bw menu key unless the RRC Filter is on, then the integration bandwidth used is the displayed value, which is $(1 + \alpha)/T$ where $T = 1/(\text{Offset Integ Bw})$.

Offset Absolute Power

This is the absolute power in the offsets. The power is calculated by integrating across the bandwidth declared by the Offset Integ Bw parameter. The offset integration bandwidth is shown as part of the result. This is the value on the Offset Integ Bw menu key unless the RRC Filter is on, then the integration

bandwidth used is the displayed value, which is $(1 + \alpha)/T$ where $T = 1/(\text{Offset Integ Bw})$.

Key Path	Front-panel key
Initial S/W Revision	Prior to A.02.00
Help Map ID	7105

Display

Accesses a menu of functions that enable you to set the display parameters.

See [Display@3440@i](#) for more information.

Key Path	View/Display
Initial S/W Revision	Prior to A.02.00
Help Map ID	7080

Bar Graph

Turns the Bar Graph On and Off.

Key Path	View/Display
Mode	WCDMA, C2K, WIMAX OFDMA, TD-SCDMA, 1xEVDO, LTE, LTETDD
Remote Command	:DISPlay:ACPower:VIEW [1] :WINDow [1] :BGRaph OFF ON 0 1 :DISPlay:ACPower:VIEW [1] :WINDow [1] :BGRaph?
Example	DISP:ACP:VIEW:WIND:BGR OFF DISP:ACP:VIEW:WIND:BGR?
Notes	You must be in the mode that includes ACP measurements to use this command. Use :INSTrument:SElect to set the mode.
Dependencies	When the method is RBW, this key is always set to On and grayed out.
Preset	ON
State Saved	Saved in instrument state.
Range	On Off
Initial S/W Revision	Prior to A.02.00
Modified at S/W Revision	A.02.00, A.03.00
Help Map ID	7007

The spectrum emission mask measures spurious signal levels in up to six pairs of offset frequencies and relates them to the carrier power. For measurement results and views, see [“View/Display” on page 652](#).

This topic contains the following sections:

[“Measurement Commands for Spectrum Emission Mask” on page 553](#)

[“Remote Command Results for Spectrum Emission Mask Measurement” on page 553](#)

[“Number of Offsets” on page 570](#)

Measurement Commands for Spectrum Emission Mask

Offsets that are turned off (inactive) return -999.0 when their results are queried via SCPI.

:CONFigure:SEMask

:CONFigure:SEMask:NDEFault

:INITiate:SEMask

:FETCh:SEMask [n] ?

:MEASure:SEMask [n] ?

:READ:SEMask [n] ?

For more measurement related commands, see the SENSE subsystem, and the section [Remote Measurement Functions@29978](#).

Remote Command Results for Spectrum Emission Mask Measurement

The following table describes the results returned by the FETCh, MEASure, and READ queries listed above, according to the index value n:

Modes	n	Return Value
All except WLAN	1	<p>Meas Type: Total Power Reference</p> <p>Returns 82 comma-separated scalar results, in the following order:</p> <ol style="list-style-type: none"> 1. Reserved for the future use, returns -999.0 2. Absolute power at the center frequency (reference) area (dBm) 3. Reserved for the future use, returns -999.0 4. Reserved for the future use, returns -999.0 5. Peak frequency in the center frequency (reference) area (Hz) 6. Reserved for the future use, returns -999.0 7. Reserved for the future use, returns -999.0 8. Reserved for the future use, returns -999.0

Modes	n	Return Value
All except WLAN (Cont)	1 (Cont)	<p>Meas Type: Total Power Reference (Cont)</p> <p>9. Reserved for the future use, returns –999.0</p> <p>10. Reserved for the future use, returns –999.0</p> <p>11. Relative integrated power on the negative offset A (dBc)</p> <p>12. Absolute integrated power on the negative offset A (dBm)</p> <p>13. Relative peak power on the negative offset A (dBc)</p> <p>14. Absolute peak power on the negative offset A (dBm)</p> <p>15. Peak power offset frequency from the center or carrier edge frequency in the negative offset A, depending on Offset Frequency Define settings (Hz)</p> <p>16. Relative integrated power on the positive offset A (dBc)</p> <p>17. Absolute integrated power on the positive offset A (dBm)</p> <p>18. Relative peak power on the positive offset A (dBc)</p> <p>19. Absolute peak power on the positive offset A (dBm)</p> <p>20. Peak power offset frequency from the center or carrier edge frequency in the positive offset A, depending on Offset Frequency Define settings (Hz)</p> <p>21. Relative integrated power on the negative offset B (dBc)</p> <p>...</p> <p>69. Absolute peak power on the positive offset F (dBm)</p> <p>70. Peak power offset frequency from the center or carrier edge frequency in the positive offset F, depending on Offset Frequency Define settings (Hz)</p> <p>71. Minimum margin from limit line on the negative offset A (dB)</p> <p>72. Minimum margin from limit line on the positive offset A (dB)</p> <p>73. Minimum margin from limit line on the negative offset B (dB)</p> <p>74. Minimum margin from limit line on the positive offset B (dB)</p> <p>75. Minimum margin from limit line on the negative offset C (dB)</p> <p>76. Minimum margin from limit line on the positive offset C (dB)</p> <p>77. Minimum margin from limit line on the negative offset D (dB)</p> <p>78. Minimum margin from limit line on the positive offset D (dB)</p> <p>79. Minimum margin from limit line on the negative offset E (dB)</p> <p>80. Minimum margin from limit line on the positive offset E (dB)</p> <p>81. Minimum margin from limit line on the negative offset F (dB)</p> <p>82. Minimum margin from limit line on the positive offset F (dB)</p>

Modes	n	Return Value
All except WLAN	1	<p>Meas Type: Power Spectral Density Reference</p> <p>Returns 82 comma-separated scalar results, in the following order:</p> <ol style="list-style-type: none"> 1. Reserved for the future use, returns -999.0 2. Absolute power at the center frequency (reference) area (dBm/Hz) 3. Reserved for the future use, returns -999.0 4. Reserved for the future use, returns -999.0 5. Peak frequency in the center frequency (reference) area (Hz) 6. Reserved for the future use, returns -999.0 7. Reserved for the future use, returns -999.0 8. Reserved for the future use, returns -999.0 9. Reserved for the future use, returns -999.0 10. Reserved for the future use, returns -999.0 11. Relative integrated power on the negative offset A (dB). 12. Absolute integrated power on the negative offset A (dBm/Hz). 13. Relative peak power on the negative offset A (dB) 14. Absolute peak power on the negative offset A (dBm/Hz) 15. Peak power offset frequency from the center or carrier edge frequency in the negative offset A, depending on Offset Frequency Define settings (Hz) 16. Relative integrated power on the positive offset A (dB). 17. Absolute integrated power on the positive offset A (dBm/Hz). 18. Relative peak power on the positive offset A (dB) 19. Absolute peak power on the positive offset A (dBm/Hz) 20. Peak power offset frequency from the center or carrier edge frequency in the positive offset A, depending on Offset Frequency Define settings (Hz) 21. Relative integrated power on the negative offset B (dB). ... 69. Absolute peak power on the positive offset F (dBm/Hz) 70. Peak power offset frequency from the center or carrier edge frequency in the positive offset F, depending on Offset Frequency Define settings (Hz) 71. Minimum margin from limit line on the negative offset A (dB) 72. Minimum margin from limit line on the positive offset A (dB) 73. Minimum margin from limit line on the negative offset B (dB) 74. Minimum margin from limit line on the positive offset B (dB) 75. Minimum margin from limit line on the negative offset C (dB) 76. Minimum margin from limit line on the positive offset C (dB)

Modes	n	Return Value
All except WLAN (Cont)	1 (Cont)	<p>Meas Type: Power Spectral Density Reference (Cont)</p> <p>77. Minimum margin from limit line on the negative offset D (dB)</p> <p>78. Minimum margin from limit line on the positive offset D (dB)</p> <p>79. Minimum margin from limit line on the negative offset E (dB)</p> <p>80. Minimum margin from limit line on the positive offset E (dB)</p> <p>81. Minimum margin from limit line on the negative offset F (dB)</p> <p>82. Minimum margin from limit line on the positive offset F (dB)</p>
All except WLAN	1	<p>Meas Type: Spectrum Peak Reference</p> <p>Returns 82 comma-separated scalar results, in the following order:</p> <ol style="list-style-type: none"> 1. Reserved for the future use, returns –999.0 2. Peak power at the center frequency (reference) area (dBm) 3. Reserved for the future use, returns –999.0 4. Reserved for the future use, returns –999.0 5. Peak frequency in the center frequency (reference) area (Hz) 6. Reserved for the future use, returns –999.0 7. Reserved for the future use, returns –999.0 8. Reserved for the future use, returns –999.0 9. Reserved for the future use, returns –999.0 10. Reserved for the future use, returns –999.0 11. Reserved for the future use, returns –999.0 12. Reserved for the future use, returns –999.0 13. Relative peak power on the negative offset A (dB) 14. Absolute peak power on the negative offset A (dBm) 15. Peak power offset frequency from the center or carrier edge frequency in the negative offset A, depending on Offset Frequency Define settings (Hz) 16. Reserved for the future use, returns –999.0 17. Reserved for the future use, returns –999.0 18. Relative peak power on the positive offset A (dB) 19. Absolute peak power on the positive offset A (dBm) 20. Peak power offset frequency from the center or carrier edge frequency in the positive offset A, depending on Offset Frequency Define settings (Hz) 21. Reserved for the future use, returns –999.0 ... 69. Absolute peak power on the positive offset F (dBm)

Modes	n	Return Value
All except WLAN (Cont)	1 (Cont)	<p>Meas Type: Spectrum Peak Reference (Cont)</p> <p>70. Peak power offset frequency from the center or carrier edge frequency in the positive offset F, depending on Offset Frequency Define settings (Hz)</p> <p>71. Minimum margin from limit line on the negative offset A (dB)</p> <p>72. Minimum margin from limit line on the positive offset A (dB)</p> <p>73. Minimum margin from limit line on the negative offset B (dB)</p> <p>74. Minimum margin from limit line on the positive offset B (dB)</p> <p>75. Minimum margin from limit line on the negative offset C (dB)</p> <p>76. Minimum margin from limit line on the positive offset C (dB)</p> <p>77. Minimum margin from limit line on the negative offset D (dB)</p> <p>78. Minimum margin from limit line on the positive offset D (dB)</p> <p>79. Minimum margin from limit line on the negative offset E (dB)</p> <p>80. Minimum margin from limit line on the positive offset E (dB)</p> <p>81. Minimum margin from limit line on the negative offset F (dB)</p> <p>82. Minimum margin from limit line on the positive offset F (dB)</p>
WLAN, with radio standard 802.11 ac (80 MHz + 80 MHz)	1	<p>Meas Type: Total Power Reference (Cont)</p> <p>Returns 82 comma-separated scalar results, in the following order:</p> <ol style="list-style-type: none"> 1. Reserved for the future use, returns -999.0 2. Absolute reference power (dBm) 3. Absolute power of the carrier of which the frequency is indicated by Freq Segment 1 (dBm) 4. Absolute power of the carrier of which the frequency is indicated by Freq Segment 2 (dBm) 5. Peak frequency in the center frequency (reference) area (Hz) 6. Reserved for the future use, returns -999.0 7. Reserved for the future use, returns -999.0 8. Reserved for the future use, returns -999.0 9. Reserved for the future use, returns -999.0 10. Reserved for the future use, returns -999.0 11. Relative integrated power on the negative offset A (dBc) 12. Absolute integrated power on the negative offset A (dBm) 13. Relative peak power on the negative offset A (dBc) 14. Absolute peak power on the negative offset A (dBm) 15. Peak power offset frequency from the center or carrier edge frequency in the negative offset A, depending on Offset Frequency Define settings (Hz)

Modes	n	Return Value
WLAN, with radio standard 802.11 ac (80 MHz + 80 MHz) (Cont)	1 (Cont)	Meas Type: Total Power Reference (Cont) 16. Relative integrated power on the positive offset A (dBc) 17. Absolute integrated power on the positive offset A (dBm) 18. Relative peak power on the positive offset A (dBc) 19. Absolute peak power on the positive offset A (dBm) 20. Peak power offset frequency from the center or carrier edge frequency in the positive offset A, depending on Offset Frequency Define settings (Hz) 21. Relative integrated power on the negative offset B (dBc) ... 69. Absolute peak power on the positive offset F (dBm) 70. Peak power offset frequency from the center or carrier edge frequency in the positive offset F, depending on Offset Frequency Define settings (Hz) 71. Minimum margin from limit line on the negative offset A (dB) 72. Minimum margin from limit line on the positive offset A (dB) 73. Minimum margin from limit line on the negative offset B (dB) 74. Minimum margin from limit line on the positive offset B (dB) 75. Minimum margin from limit line on the negative offset C (dB) 76. Minimum margin from limit line on the positive offset C (dB) 77. Minimum margin from limit line on the negative offset D (dB) 78. Minimum margin from limit line on the positive offset D (dB) 79. Minimum margin from limit line on the negative offset E (dB) 80. Minimum margin from limit line on the positive offset E (dB) 81. Minimum margin from limit line on the negative offset F (dB) 82. Minimum margin from limit line on the positive offset F (dB)

Modes	n	Return Value
WLAN, with radio standard 802.11 ac (80 MHz + 80 MHz)	1	<p>Meas Type: Power Spectral Density Reference</p> <p>Returns 82 comma-separated scalar results, in the following order:</p> <ol style="list-style-type: none"> 1. Reserved for the future use, returns -999.0 2. Absolute reference power(dBm/Hz) 3. Absolute power of the carrier of which the frequency is indicated by Freq Segment 1 (dBm/Hz) 4. Absolute power of the carrier of which the frequency is indicated by Freq Segment 2 (dBm/Hz) 5. Peak frequency in the center frequency (reference) area (Hz) 6. Reserved for the future use, returns -999.0 7. Reserved for the future use, returns -999.0 8. Reserved for the future use, returns -999.0 9. Reserved for the future use, returns -999.0 10. Reserved for the future use, returns -999.0 11. Relative integrated power on the negative offset A (dB). 12. Absolute integrated power on the negative offset A (dBm/Hz). 13. Relative peak power on the negative offset A (dB) 14. Absolute peak power on the negative offset A (dBm/Hz) 15. Peak power offset frequency from the center or carrier edge frequency in the negative offset A, depending on Offset Frequency Define settings (Hz) 16. Relative integrated power on the positive offset A (dB). 17. Absolute integrated power on the positive offset A (dBm/Hz). 18. Relative peak power on the positive offset A (dB) 19. Absolute peak power on the positive offset A (dBm/Hz) 20. Peak power offset frequency from the center or carrier edge frequency in the positive offset A, depending on Offset Frequency Define settings (Hz) 21. Relative integrated power on the negative offset B (dB). ... 69. Absolute peak power on the positive offset F (dBm/Hz) 70. Peak power offset frequency from the center or carrier edge frequency in the positive offset F, depending on Offset Frequency Define settings (Hz) 71. Minimum margin from limit line on the negative offset A (dB) 72. Minimum margin from limit line on the positive offset A (dB) 73. Minimum margin from limit line on the negative offset B (dB) 74. Minimum margin from limit line on the positive offset B (dB)

Modes	n	Return Value
WLAN, with radio standard 802.11 ac (80 MHz + 80 MHz) (Cont)	1 (Cont)	Meas Type: Power Spectral Density Reference (Cont) 76. Minimum margin from limit line on the positive offset C (dB) 77. Minimum margin from limit line on the negative offset D (dB) 78. Minimum margin from limit line on the positive offset D (dB) 79. Minimum margin from limit line on the negative offset E (dB) 80. Minimum margin from limit line on the positive offset E (dB) 81. Minimum margin from limit line on the negative offset F (dB) 82. Minimum margin from limit line on the positive offset F (dB)
All	2	Returns the displayed frequency domain spectrum trace data separated by comma. The number of data is points 2001.
All	3	Returns the displayed frequency domain absolute limit trace data separated by comma. The number of data points is 2001.
All	4	Returns the displayed frequency domain relative limit trace data separated by comma. The number of data points is 2001.

Modes	n	Return Value
All (see details)	5	<p>Meas Type: Total Power Reference</p> <p>Returns comma-separated scalar values (in dBm) of the absolute integrated power of the segment frequencies. The length of the result depends on the number of available offset (See “Number of Offsets” on page 570).</p> <ol style="list-style-type: none"> 1. Total power reference (dBm) 2. Reserved for the future use, returns –999.0 3. Absolute integrated power at negative offset frequency (A) 4. Absolute integrated power at positive offset frequency (A) ... 25. Absolute integrated power at negative offset frequency (L) 26. Absolute integrated power at positive offset frequency (L) <p>In WLAN mode.</p> <p>Returns 26 comma-separated scalar values (in dBm) of the absolute integrated power of the segment frequencies:</p> <ol style="list-style-type: none"> 1. Ref carrier power (dBm) 2. Reserved for the future use, returns –999.0 3. Absolute integrated power at negative offset frequency (A) 4. Absolute integrated power at positive offset frequency (A) ... 25. Absolute integrated power at negative offset frequency (L) 26. Absolute integrated power at positive offset frequency (L) <p>If the result is not available, –999.0 is returned.</p> <p>The number of values returned is subject to change in future releases.</p>

Modes	n	Return Value
All (see details)	5	<p>Meas Type: Power Spectral Density Reference</p> <p>Returns comma-separated scalar values (in dBm/Hz) of the absolute integrated power of the segment frequencies. The length of the result depends on the number of available offset (See “Number of Offsets” on page 570).</p> <p>Returns –999.0 for the offsets if in WLAN:</p> <ol style="list-style-type: none"> 1. Power spectral density reference (dBm/Hz) 2. Reserved for the future use, returns –999.0 3. Absolute integrated power at negative offset frequency (A) 4. Absolute integrated power at positive offset frequency (A) ... 25. Absolute integrated power at negative offset frequency (L) 26. Absolute integrated power at positive offset frequency (L) <p>In WLAN mode.</p> <p>Returns 26 comma-separated scalar values (in dBm/Hz) of the absolute integrated power of the segment frequencies:</p> <ol style="list-style-type: none"> 1. Ref carrier power (dBm/Hz) 2. Reserved for the future use, returns –999.0 3. Absolute integrated power at negative offset frequency (A) 4. Absolute integrated power at positive offset frequency (A) ... 25. Absolute integrated power at negative offset frequency (L) 26. Absolute integrated power at positive offset frequency (L) <p>If the result is not available, –999.0 is returned.</p> <p>The number of values returned is subject to change in future releases.</p>
All (see details)	5	<p>Meas Type: Spectrum Peak Reference</p> <p>Returns comma-separated scalar values (in dBm) of the absolute peak power of the segment frequencies. The length of the result depends on the number of available offset (See “Number of Offsets” on page 570).</p> <ol style="list-style-type: none"> 1. Spectrum Peak Power reference (dBm) 2. Reserved for the future use, returns –999.0 3. Absolute peak power at negative offset frequency (A) 4. Absolute peak power at positive offset frequency (A) ... 25. Absolute peak power at negative offset frequency (L) 26. Absolute peak power at positive offset frequency (L)

Modes	n	Return Value
All	6	<p>Meas Type: Total Power Reference</p> <p>Returns comma-separated scalar values (in dBc) of the integrated power relative to the carrier at the segment frequencies. The length of the result depends on the number of available offset (See “Number of Offsets” on page 570).</p> <ol style="list-style-type: none"> 1. Reserved for the future use, returns –999.0 2. Reserved for the future use, returns –999.0 3. Relative integrated power at negative offset frequency (A) 4. Relative integrated power at positive offset frequency (A) ... 25. Relative integrated power at negative offset frequency (L) 26. Relative integrated power at positive offset frequency (L) <p>If the result is not available, –999.0 is returned.</p> <p>The number of values returned is subject to change in future releases.</p>
All	6	<p>Meas Type: Power Spectral Density Reference</p> <p>Returns 14 comma-separated scalar values (in dBc/Hz) of the integrated power relative to the carrier at the segment frequencies. The length of the result depends on the number of available offset (See “Number of Offsets” on page 570). Returns –999.0 for the offsets if in WLAN:</p> <ol style="list-style-type: none"> 1. Reserved for the future use, returns –999.0 2. Reserved for the future use, returns –999.0 3. Relative integrated power at negative offset frequency (A) 4. Relative integrated power at positive offset frequency (A) ... 25. Relative integrated power at negative offset frequency (L) 26. Relative integrated power at positive offset frequency (L) <p>If the result is not available, –999.0 is returned.</p> <p>The number of values returned is subject to change in future releases.</p>

Modes	n	Return Value
All	6	<p>Meas Type: Spectrum Peak Reference</p> <p>Returns comma-separated scalar values (in dB) of the integrated power relative to the carrier at the segment frequencies. The length of the result depends on the number of available offset (See “Number of Offsets” on page 570).</p> <ol style="list-style-type: none"> 1. Reserved for the future use, returns –999.0 2. Reserved for the future use, returns –999.0 3. Relative peak power at negative offset frequency (A) 4. Relative peak power at positive offset frequency (A) ... 25. Relative peak power at negative offset frequency (L) 26. Relative peak power at positive offset frequency (L) <p>If the result is not available, –999.0 is returned.</p> <p>The number of values returned is subject to change in future releases.</p>
All	7	<p>Returns comma-separated pass/fail test results (0=passed, or 1=failed) determined by testing the minimum margin point from the limit line that is determined each offset's Limits setting. The length of the result depends on the number of available offset (See “Number of Offsets” on page 570).</p> <ol style="list-style-type: none"> 1. Reserved for the future use, returns –999.0 2. Reserved for the future use, returns –999.0 3. At negative offset frequency (A) 4. At positive offset frequency (A) ... 25. At negative offset frequency (L) 26. At positive offset frequency (L) <p>The number of values returned is subject to change in future releases.</p>

Modes	n	Return Value
All	8	<p>Returns comma-separated pass/fail test results (0=passed, or 1=failed) determined by testing the minimum margin point from the limit line that is determined each offset's Limits setting. The length of the result depends on the number of available offset (See “Number of Offsets” on page 570).</p> <p>Note: These results (n=8) are the same as n=7 result.</p> <ol style="list-style-type: none"> 1. Reserved for the future use, returns -999.0 2. Reserved for the future use, returns -999.0 3. At negative offset frequency (A) 4. At positive offset frequency (A) ... 25. At negative offset frequency (L) 26. At positive offset frequency (L) <p>The number of values returned is subject to change in future releases.</p>
All	10	<p>Returns comma-separated scalar values (in dBm) of the absolute peak power of the segment frequencies. The length of the result depends on the number of available offset (See “Number of Offsets” on page 570).</p> <ol style="list-style-type: none"> 1. Reserved for the future use, returns -999.0 2. Reserved for the future use, returns -999.0 3. At negative offset frequency (A) 4. At positive offset frequency (A) ... 25. At negative offset frequency (L) 26. At positive offset frequency (L) <p>If the result is not available, -999.0 is returned.</p> <p>The number of values returned is subject to change in future releases.</p>

Spectrum Emission Mask Measurement

Modes	n	Return Value
All	11	<p>Returns comma-separated scalar values in dBc (dB if MeasType = PSD) of the peak power relative to the carrier at the segment frequencies. The length of the result depends on the number of available offset (See “Number of Offsets” on page 570).</p> <ol style="list-style-type: none"> 1. Reserved for the future use, returns –999.0 2. Reserved for the future use, returns –999.0 3. At negative offset frequency (A) 4. At positive offset frequency (A) ... 25. At negative offset frequency (L) 26. At positive offset frequency (L) <p>If the result is not available, –999.0 is returned.</p> <p>The number of values returned is subject to change in future releases.</p>
All	12	<p>Returns the power result (the peak power of the signal in the ref channel) when Meas Type is Spectrum Peak reference. Otherwise, the value returned will be –999.0</p>

Modes	n	Return Value
All	14	<p>Meas Type: Total Power Reference</p> <p>Returns comma-separated scalar results, in the following order:</p> <ol style="list-style-type: none"> 1. Relative integrated power on the negative offset A (dBc) 2. Absolute integrated power on the negative offset A (dBm) 3. Relative peak power on the negative offset A (dBc) 4. Absolute peak power on the negative offset A (dBm) 5. Peak power offset frequency from the center or carrier edge frequency in the negative offset A, depending on Offset Frequency Define settings (Hz) 6. Relative integrated power on the positive offset A (dBc) 7. Absolute integrated power on the positive offset A (dBm) 8. Relative peak power on the positive offset A (dBc) 9. Absolute peak power on the positive offset A (dBm) 10. Peak power offset frequency from the center or carrier edge frequency in the positive offset A, depending on Offset Frequency Define settings (Hz) 11. Relative integrated power on the negative offset B (dBc) ... 119. Absolute peak power on the positive offset L (dBm) 120. Peak power offset frequency from the center or carrier edge frequency in the positive offset L, depending on Offset Frequency Define settings (Hz) <p>If the result is not available, NaN (9.91E+37) is returned.</p> <p>The length of the result depends on the number of available offsets (See “Number of Offsets” on page 570).</p> <p>The number of values returned is subject to change in future releases.</p>

Modes	n	Return Value
All	14	<p>Meas Type: Power Spectral Density Reference</p> <p>Returns comma-separated scalar results, in the following order:</p> <ol style="list-style-type: none"> 1. Relative integrated power on the negative offset A (dB) 2. Absolute integrated power on the negative offset A (dBm/Hz) 3. Relative peak power on the negative offset A (dB) 4. Absolute peak power on the negative offset A (dBm/Hz) 5. Peak power offset frequency from the center or carrier edge frequency in the negative offset A, depending on Offset Frequency Define settings (Hz) 6. Relative integrated power on the positive offset A (dB) 7. Absolute integrated power on the positive offset A (dBm/Hz) 8. Relative peak power on the positive offset A (dB) 9. Absolute peak power on the positive offset A (dBm/Hz) 10. Peak power offset frequency from the center or carrier edge frequency in the positive offset A, depending on Offset Frequency Define settings (Hz) 11. Relative integrated power on the negative offset B (dB) ... 119. Absolute peak power on the positive offset L (dBm/Hz) 120. Peak power offset frequency from the center or carrier edge frequency in the positive offset L, depending on Offset Frequency Define settings (Hz) <p>If the result is not available, NaN (9.91E+37) is returned.</p> <p>The length of the result depends on the number of available offsets (See “Number of Offsets” on page 570).</p> <p>The number of values returned is subject to change in future releases.</p>

Modes	n	Return Value
All	14	<p>Meas Type: Spectrum Peak Reference</p> <p>Returns comma-separated scalar results, in the following order:</p> <ol style="list-style-type: none"> 1. Reserved for the future use, returns NaN (9.91E+37) 2. Reserved for the future use, returns NaN (9.91E+37) 3. Relative peak power on the negative offset A (dB) 4. Absolute peak power on the negative offset A (dBm) 5. Peak power offset frequency from the center or carrier edge frequency in the negative offset A, depending on Offset Frequency Define settings (Hz) 6. Reserved for the future use, returns NaN (9.91E+37) 7. Reserved for the future use, returns NaN (9.91E+37) 8. Relative peak power on the positive offset A (dB) 9. Absolute peak power on the positive offset A (dBm) 10. Peak power offset frequency from the center or carrier edge frequency in the positive offset A, depending on Offset Frequency Define settings (Hz) 11. Relative integrated power on the negative offset B (dB) ... 119. Absolute peak power on the positive offset L (dBm) 120. Peak power offset frequency from the center or carrier edge frequency in the positive offset L, depending on Offset Frequency Define settings (Hz) <p>If the result is not available, NaN (9.91E+37) is returned.</p> <p>The length of the result depends on the number of available offsets (See “Number of Offsets” on page 570).</p> <p>The number of values returned is subject to change in future releases.</p>
All	15	<p>Meas Type: Total Power Reference</p> <p>Returns comma-separated scalar results, in the following order:</p> <ol style="list-style-type: none"> 1. Minimum margin from limit line on the negative offset A (dB) 2. Minimum margin from limit line on the positive offset A (dB) 3. Minimum margin from limit line on the negative offset B (dB) 4. Minimum margin from limit line on the positive offset B (dB) ... 23. Minimum margin from limit line on the negative offset L (dB) 24. Minimum margin from limit line on the positive offset L (dB) <p>If the result is not available, NaN (9.91E+37) is returned. The length of the result depends on the number of available offsets (See “Number of Offsets” on page 570).</p> <p>The number of values returned is subject to change in future releases.</p>

Spectrum Emission Mask Measurement

Modes	n	Return Value
WLAN only	16	Returns two carriers comma-separated scalar results when the radio standard is 802.11ac 80+80 MHz. And returns NaN otherwise. 1. Absolute power of carrier segment 1 (dBm) 2. Absolute power of carrier segment 2(dBm)

Number of Offsets

The number of available offsets varies depending on the mode and option as below.

Mode	The number of available offsets
WLAN	12 (Offset A to L)

Key Path:	Meas
Initial S/W Revision:	Prior to A.02.00
Modified at S/W Revision:	A.11.00
Help Map ID:	9053

AMPTD Y Scale

Accesses a menu of functions that enable you to set the vertical scale parameters. The parameter values are measurement independent except all Attenuation values and Internal Preamp selections that are measurement global.

Key Path:	Front-panel key
Initial S/W Revision:	Prior to A.02.00
Help Map ID:	9056

Ref Value

Sets the value for the absolute power reference. However, since Auto Scaling defaults to On, this value is automatically determined by the measurement result. When you set a value manually, Auto Scaling automatically changes to Off.

Key Path:	AMPTD Y Scale
Mode:	WCDMA, C2K, WIMAX OFDMA, TD-SCDMA, 1xEVDO, LTE, LTETDD, WLAN
Remote Command:	:DISPlay:SEMask:VIEW[1]:WINDow[1]:TRACe:Y[:SCALe]:RLEV l <real> :DISPlay:SEMask:VIEW[1]:WINDow[1]:TRACe:Y[:SCALe]:RLEV l?
Example:	DISP:SEM:VIEW:WIND:TRAC:Y:RLEV 100 DISP:SEM:VIEW:WIND:TRAC:Y:RLEV?
Notes:	You must be in the mode that includes SEM measurement to use this command. Use :INSTrument:SELEct to set the mode.
Couplings:	When the Auto Scaling is On, this value is automatically determined by the measurement result. When you set a value manually, Auto Scaling automatically changed to Off.
Preset:	10.0 dBm
State Saved:	Saved in instrument state.
Min:	-250 dBm
Max:	250 dBm
Initial S/W Revision:	Prior to A.02.00
Modified at S/W Revision:	A.02.00, A.03.00
Help Map ID:	9000

Attenuation

Accesses a menu of functions that enable you to change attenuation settings. This key has read-back text that describes the total attenuator value.

See AMPTD Y Scale, [Attenuation@3003@i](#) for more information.

Key Path:	AMPTD Y Scale
Initial S/W Revision:	Prior to A.02.00
Help Map ID:	Use 3003

Scale/Div

Sets the units-per-division of the vertical scale in the logarithmic display. When Auto Scaling is On, the scale per division value is automatically determined by the measurement result. When you set a value manually, Auto Scaling automatically changes to Off.

Key Path:	AMPTD Y Scale
Mode:	WCDMA, C2K, WIMAX OFDMA, TD-SCDMA, 1xEVDO, LTE, LTETDD, WLAN
Remote Command:	:DISPlay:SEMAsk:VIEW[1]:WINDow[1]:TRACe:Y[:SCALE]:PDIv sion <rel_ampl> :DISPlay:SEMAsk:VIEW[1]:WINDow[1]:TRACe:Y[:SCALE]:PDIv sion?
Example:	DISP:SEM:VIEW:WIND:TRAC:Y:PDIV 15dB DISP:SEM:VIEW:WIND:TRAC:Y:PDIV?
Notes:	You must be in the mode that includes SEM measurement to use this command. Use :INSTrument:SELEct to set the mode.
Couplings:	When the Auto Scaling is On, this value is automatically determined by the measurement result. When you set a value manually, Auto Scaling automatically changes to Off.
Preset:	10 dB
State Saved:	Saved in instrument state
Min:	0.10 dB
Max:	20.00 dB
Initial S/W Revision:	Prior to A.02.00
Modified at S/W Revision:	A.02.00, A.03.00
Help Map ID:	9001

Y Axis Unit

Allows you to change the vertical (Y) axis amplitude unit.

See [Y Axis Unit@3021@i](#) under AMPTD Y Scale for more information.

Key Path:	AMPTD Y Scale
Initial S/W Revision:	A.04.00
Help Map ID:	0

Ref Position

Positions the reference level at the top, center or bottom of the Y scale display. Changing the reference position does not affect the reference level value.

Key Path:	AMPTD Y Scale
Mode:	WCDMA, C2K, WIMAX OFDMA, TD-SCDMA, 1xEVDO, LTE, LTETDD, WLAN
Remote Command:	:DISPlay:SEMask:VIEW[1]:WINDow[1]:TRACe:Y[:SCALE]:RPOSi tion TOP CENTer BOTTom :DISPlay:SEMask:VIEW[1]:WINDow[1]:TRACe:Y[:SCALE]:RPOSi tion?
Example:	DISP:SEM:VIEW:WIND:TRAC:Y:RPOS BOTT DISP:SEM:VIEW:WIND:TRAC:Y:RPOS?
Notes:	You must be in the mode that includes SEM measurement to use this command. Use :INSTrument:SElect to set the mode.
Preset:	TOP
State Saved:	Saved in instrument state
Range:	Top Ctr Bot
Initial S/W Revision:	Prior to A.02.00
Modified at S/W Revision:	A.02.00, A.03.00
Help Map ID:	9002

Auto Scaling

Toggles the Auto Scaling function between On and Off.

When Auto Scaling is On and the Restart front-panel key is pressed, the analyzer automatically determines the scale per division and reference values based on the measurement results. When you set a value to either Scale/Div or Ref Value manually, Auto Scaling automatically changes to Off.

Key Path:	AMPTD Y Scale
-----------	----------------------

Spectrum Emission Mask Measurement
AMPTD Y Scale

Mode:	WCDMA, C2K, WIMAX OFDMA, TD-SCDMA, 1xEVDO, LTE, LTETDD, WLAN
Remote Command:	:DISP:SEMask:VIEW[1]:WINDow[1]:TRACe:Y[:SCALe]:COUPL e 0 1 ON OFF :DISP:SEMask:VIEW[1]:WINDow[1]:TRACe:Y[:SCALe]:COUPL e?
Example:	DISP:SEM:VIEW:WIND:TRAC:Y:COUP OFF DISP:SEM:VIEW:WIND:TRAC:Y:COUP?
Notes:	You must be in the mode that includes SEM measurement to use this command. Use :INSTrument:SELEct to set the mode.
Couplings:	When Auto Scaling is On, upon pressing the Restart front-panel key, this function automatically determines the scale per division and reference values based on the measurement results. When you set a value to either Scale/Div or Ref Value manually, Auto Scaling automatically changes to Off.
Preset:	ON
State Saved:	Saved in instrument state
Range:	On Off
Initial S/W Revision:	Prior to A.02.00
Modified at S/W Revision:	A.02.00, A.03.00
Help Map ID:	9003

Auto Couple

See AUTO_COUPLE@3041@i for more information.

Key Path:	Front-panel key
Initial S/W Revision:	Prior to A.02.00
Help Map ID:	0

BW

Accesses a menu of functions that enable you to select the type of filter for the measurement.

Key Path:	Front-panel key
Initial S/W Revision:	Prior to A.02.00
Modified at S/W Revision:	A.03.00
Help Map ID:	9061

Filter Type

Selects the type of bandwidth filter that is used in Carrier and Offsets.

When Gaussian or Flattop is selected, selected filter is applied to carriers and all offsets.

When Auto Sense is selected, filter type is automatically selected for each carriers and offsets, so that measurement speed and accuracy is optimized.

Key Path:	BW
Mode:	WCDMA, C2K, WIMAX OFDMA, TD-SCDMA, 1xEVDO, LTE, LTETDD, WLAN
Remote Command:	[:SENSe] :SEMAsk:BA NDwidth:SHA Pe ASENse GAUSSian FLATtop [:SENSe] :SEMAsk:BA NDwidth:SHA Pe?
Example:	SEM:BA ND:SHA P GAUS SEM:BA ND:SHA P?
Couplings:	See the description above
Preset:	ASENSE
State Saved:	Saved in instrument state
Range:	Auto Sense (each offset and carrier) Gaussian (all offsets and carriers) Flattop (all offsets and carriers)
Initial S/W Revision:	A.03.00
Help Map ID:	9078

Cont

See Cont@3309@i for more information.

Key Path:	Front-panel key
Initial S/W Revision:	Prior to A.02.00
Help Map ID:	0

FREQ Channel

See [FREQ Channel@\(SA, LTE, LTE TDD, OFDMA, WCDMA, WLAN, 1xEVDO, TD-SCDMA\)3057, \(cdma2000\)26103, \(DVB-T/H\)31073, \(DTMB\)30868, \(CMMB\)40063, \(ISDB-T\)40276, \(Digital Cable TV\)41906, \(MSR\)45070](#) for more information.

Key Path:	Front-panel key
Initial S/W Revision:	Prior to A.02.00
Help Map ID:	0

Input/Output

See [Input/Output@3065](#) for more information.

Key Path:	Front-panel key
Initial S/W Revision:	Prior to A.02.00
Help Map ID:	0

Marker

Accesses a menu that enables you to select, set up and control the markers for the current measurement. If there are no active markers, **Marker** selects marker 1, sets it to Normal and places it at the center of the display. You can turn on and control up to 12 markers.

Key Path:	Front-panel key
Initial S/W Revision:	Prior to A.02.00
Help Map ID:	9071

Select Marker

Displays 12 markers available for selection.

Key Path:	Marker
Initial S/W Revision:	Prior to A.02.00
Help Map ID:	9038

Marker Type

Sets the marker control mode to Normal and Off. If the selected marker is Off, pressing Marker sets it to Normal and places it at the center of the screen on the trace determined by the **Marker Trace** rules. At the same time, **Marker X Axis Value** appears on the Active Function area. The marker X axis value entered in the active function area will display the marker value to its full entered precision. If the current control mode for the measurement is Off, there is no active function and the active function is turned off.

Key Path:	Marker
Mode:	WCDMA, C2K, WIMAX OFDMA, TD-SCDMA, 1xEVDO, LTE, LTETDD, WLAN
Remote Command:	:CALCulate:SEMask:MARKer [1] 2 3 4 5 6 7 8 9 10 11 12 :MO DE POSition OFF :CALCulate:SEMask:MARKer [1] 2 3 4 5 6 7 8 9 10 11 12 :MO DE?
Example:	CALC:SEM:MARK:MODE POS CALC:SEM:MARK:MODE?

Notes:	<p>If the selected marker is Off, pressing Marker sets it to Normal and places it at the center of the screen on the trace determined by the Marker Trace rules. At the same time, Marker X Axis Value appears on the Active Function area.</p> <p>Default Active Function: the active function for the selected marker's current control mode. Note that if the current control mode is Off, there is no active function and the active function is turned off.</p> <p>Active Function Display: the marker X axis value entered in the active function area will display the marker value to its full entered precision.</p>
Preset:	OFF OFF OFF OFF OFF OFF OFF OFF OFF OFF OFF OFF
State Saved:	Saved in instrument state
Range:	Normal Off
Initial S/W Revision:	Prior to A.02.00
Modified at S/W Revision:	A.02.00, A.03.00
Help Map ID:	9046

Marker X Axis Value (Remote Command Only)

Sets the marker X Axis value in the current marker X Axis Scale unit. It has no effect if the control mode is Off, but is the SCPI equivalent of entering an X value if the control mode is **Normal**.

Mode:	WCDMA, C2K, WIMAX OFDMA, TD-SCDMA, 1xEVDO, LTE, LTETDD, WLAN
Remote Command:	<pre>:CALCulate:SEMask:MARKer [1] 2 3 4 5 6 7 8 9 10 11 12 :X <freq></pre> <pre>:CALCulate:SEMask:MARKer [1] 2 3 4 5 6 7 8 9 10 11 12 :X?</pre>
Example:	<pre>CALC:SEM:MARK3:X 1.0 GHz</pre> <pre>CALC:SEM:MARK3:X?</pre>
Notes:	<p>If no suffix is sent it will use the fundamental units for the current marker X Axis Scale. If a suffix is sent that does not match the current marker X Axis Scale unit, an error "Invalid suffix" will be generated.</p> <p>The query returns the marker's absolute X Axis value if the control mode is Normal. The query is returned in the fundamental units for the current marker X Axis scale. If the marker is Off the response is not a number.</p> <p>When a Marker is turned on, it is placed center of the screen on the trace. Therefore the default value depends on instrument condition, although the Preset/Default is defined as 1.5 GHz.</p>
Preset:	After a preset, all Markers are turned OFF, so a Marker X Axis Value query will return a not a number (NAN).
State Saved:	No
Min:	-9.9E+37

Spectrum Emission Mask Measurement
Marker

Max:	9.9E+37
Initial S/W Revision:	Prior to A.02.00
Modified at S/W Revision:	A.02.00, A.03.00
Help Map ID:	0

Marker X Axis Position (Remote Command Only)

Sets the marker X position in trace points. It has no effect if the control mode is **Off**, but is the SCPI equivalent of entering a value if the control mode is **Normal**, except in trace points rather than X Axis Scale units. The entered value is immediately translated into the current X Axis Scale units for setting the value of the marker.

Mode:	WCDMA, C2K, WIMAX OFDMA, TD-SCDMA, 1xEVDO, LTE, LTETDD, WLAN
Remote Command:	:CALCulate:SEMask:MARKer [1] 2 3 4 5 6 7 8 9 10 11 12 :X: POSition <real> :CALCulate:SEMask:MARKer [1] 2 3 4 5 6 7 8 9 10 11 12 :X: POSition?
Example:	CALC:SEM:MARK10:X:POS 1001 CALC:SEM:MARK10:X:POS?
Notes:	The query returns the marker's absolute X Axis value in trace points if the control mode is Normal . The value is returned as a real number, not an integer, corresponding to the translation from X Axis Scale units to trace points . If the marker is Off the response is not a number. When a Marker is turned on, it is placed center of the screen on the trace. Therefore the default value depends on the instrument condition although the Preset/Default is defined as 6507 (this value might be the expected value when all the offsets are on).
Preset:	After a preset, all Markers are turned OFF, so a Marker X Axis Value query will return a not a number (NAN).
State Saved:	No
Min:	-9.9E+37
Max:	9.9E+37
Initial S/W Revision:	Prior to A.02.00
Modified at S/W Revision:	A.02.00, A.03.00
Help Map ID:	0

Marker Y Axis Value (Remote Command Only)

Returns the marker Y Axis value in the current marker Y Axis unit.

Mode:	WCDMA, C2K, WIMAX OFDMA, TD-SCDMA, 1xEVDO, LTE, LTETDD, WLAN
Remote Command:	:CALCulate:SEMask:MARKer[1] 2 3 4 5 6 7 8 9 10 11 12:Y?
Example:	CALC:SEM:MARK11:Y 10 dBm CALC:SEM:MARK11:Y?
Notes:	Since the result value is always calculated from acquisition data, the default value is arbitrary, although the Preset/Default values is defined.
Preset:	Result dependent on markers setup and signal source
State Saved:	No
Backwards Compatibility SCPI:	:CALCulate:SEMask:MARKer[1] 2 3 4 5 6 7 8 9 10 11 12:FUNCTION:RESult?
Initial S/W Revision:	Prior to A.02.00
Modified at S/W Revision:	A.02.00, A.03.00
Help Map ID:	0

Couple Markers

When this function is true, moving any marker causes an equal X Axis movement of every other marker that is not **Off**. By “equal X Axis movement” we mean that we preserve the difference between each marker’s X Axis value (in the fundamental x-axis units of the trace that marker is on) and the X Axis value of the marker being moved (in the same fundamental x-axis units).

Key Path:	Marker
Mode:	WCDMA, C2K, WIMAX OFDMA, TD-SCDMA, 1xEVDO, LTE, LTETDD, WLAN
Remote Command:	:CALCulate:SEMask:MARKer:COUple[:STATe] ON OFF 1 0 :CALCulate:SEMask:MARKer:COUple[:STATe]?
Example:	CALC:SEM:MARK:COUP ON CALC:SEM:MARK:COUP?
Preset:	OFF
State Saved:	Saved in instrument state
Range:	On Off
Initial S/W Revision:	Prior to A.02.00
Modified at S/W Revision:	A.02.00, A.03.00
Help Map ID:	9050

All Markers Off

Turns all active markers off in all views.

Key Path:	Marker
Mode:	WCDMA, C2K, WIMAX OFDMA, TD-SCDMA, 1xEVDO, LTE, LTETDD, WLAN
Remote Command:	:CALCulate:SEMask:MARKer:AOff
Example:	CALC:SEM:MARK:AOff
Initial S/W Revision:	Prior to A.02.00
Modified at S/W Revision:	A.02.00, A.03.00
Help Map ID:	9051

Marker Function

There are no 'Marker Functions' supported in Spectrum Emission Mask so this front-panel key displays a blank menu when pressed.

Key Path:	Front-panel key
Initial S/W Revision:	Prior to A.02.00
Help Map ID:	9074

Marker To

There is no 'Marker To' functionality supported in Spectrum Emission Mask so this front-panel key displays a blank menu when pressed.

Key Path:	Front-panel key
Initial S/W Revision:	Prior to A.02.00
Help Map ID:	9073

Meas

See Meas@4008@i for more information.

Key Path:	Front-panel key
Initial S/W Revision:	Prior to A.02.00
Help Map ID:	0

Meas Setup

Displays the setup menu for the currently selected measurement.

Key Path:	Front-panel key
Initial S/W Revision:	Prior to A.02.00
Help Map ID:	9062

Avg/Hold Num

Toggles averaging On or Off in addition to enabling you to set the number of measurement averages used to calculate the measurement result. The average is displayed at the end of each sweep. After the specified number of average counts, the average mode (termination control) setting determines the average action.

In the remote mode, use the Average State command to turn averaging on or off.

Key Path:	Meas Setup
Mode:	WCDMA, C2K, WIMAX OFDMA, TD-SCDMA, 1xEVDO, LTE, LTETDD, WLAN
Remote Command:	[:SENSe]:SEMAsk:AVERage:COUNT <integer> [:SENSe]:SEMAsk:AVERage:COUNT? [:SENSe]:SEMAsk:AVERage[:STATe] ON OFF 1 0 [:SENSe]:SEMAsk:AVERage[:STATe]?
Example:	SEM:AVER:COUN 100 SEM:AVER:COUN? SEM:AVER ON SEM:AVER?
Notes:	You must be in the mode that includes SEM measurement to use this command. Use :INSTrument:SELEct to set the mode.
Preset:	10 OFF
State Saved:	Saved in instrument state.
Min:	1
Max:	10000
Initial S/W Revision:	Prior to A.02.00
Modified at S/W Revision:	A.02.00, A.03.00

Help Map ID:	9012
--------------	------

Meas Type

Accesses a menu that enables you to select one of the following measurement reference types:

- Total Pwr Ref – Sets the reference to the total carrier power and the measured data is shown in dBc and dBm.
- PSD Ref – Sets the reference to the mean power spectral density of the carrier and the measured data is shown in dB and dBm/Hz.
- Spectrum Peak Ref – Sets the reference to the spectrum peak power of the carrier and the measured data is shown in dB and dBm.

Key Path:	Meas Setup
Mode:	WCDMA, C2K, WIMAX OFDMA, TD-SCDMA, 1xEVDO, LTE, LTETDD, WLAN
Remote Command:	[:SENSE] :SEMAsk:TYPE PSDRef TPref SPRef [:SENSE] :SEMAsk:TYPE ?
Example:	SEM:TYPE PSDR SEM:TYPE?
Notes:	You must be in the mode that includes SEM measurement to use this command. Use :INSTrument:SElect to set the mode.
Preset:	WCDMA, C2K, TD-SCDMA, 1xEVDO, LTE, LTETDD: TPref WIMAX OFDMA, WLAN: SPRef
State Saved:	Saved in instrument state.
Range:	Total Pwr Ref PSD Ref Spectrum Peak Ref
Initial S/W Revision:	Prior to A.02.00
Modified at S/W Revision:	A.02.00, A.03.00
Help Map ID:	9013

Ref Channel

Accesses a menu that enables you to set up the measurement parameters used to calculate the power in the reference channel.

Key Path:	Meas Setup
Initial S/W Revision:	Prior to A.02.00
Help Map ID:	9063

Spectrum Emission Mask Measurement
Meas Setup

Integ BW

Specifies the integration bandwidth used to calculate the power in the reference channel.

Key Path:	Meas Setup, Ref Channel
Mode:	WCDMA, C2K, WIMAX OFDMA, TD-SCDMA, 1xEVDO, LTE, LTETDD, WLAN
Remote Command:	[:SENSe] :SEMAsk:BAWdth[1] 2:INTEgration <bandwidth> [:SENSe] :SEMAsk:BAWdth[1] 2:INTEgration?
Example:	SEM:BAW:INT 10 MHz SEM:BAW:INT?
Notes:	10% . 100% of Channel Span Parameter Value Bandwidth sub op code, 1 is for BTS, 2 for MS. Default is BTS. You must be in the mode that includes SEM measurement to use this command. Use :INSTrument:SELect to set the mode.
Couplings:	Cannot be higher than the channel Span. If lower than 1/10 of channel Span, then the channel Span is reduced to be 10 times the Integ BW.
Preset:	WCDMA: 3.84 MHz 3.84 MHz C2K: 1.23 MHz 1.23 MHz WIMAX OFDMA: 10 MHz 10 MHz TD-SCDMA: 1.28 MHz 1.28 MHz 1xEVDO: 1.23MHz LTE: 4.515MHz 4.5MHz LTETDD: 4.515MHz 4.5MHz WLAN: if Radio Std is 802.11a/g(OFDM/DSSS-OFDM)/802.11n(20 MHz)/ 802.11ac (20 MHz): 18 MHz if Radio Std is 802.11b/g(DSSS/CCK/PBCC): 22 MHz if Radio Std is 802.11n(40MHz)/ 802.11ac (40 MHz): 38 MHz if Radio Std is 802.11ac (80 MHz): 78 MHz if Radio Std is 802.11ac (160 MHz): 158 MHz if Radio Std is 802.11ac (80 MHz + 80 MHz): 78 MHz
State Saved:	Saved in instrument state.
Min:	1 kHz
Max:	645 MHz
Initial S/W Revision:	Prior to A.02.00
Modified at S/W Revision:	A.02.00, A.03.00

Help Map ID:	9014
--------------	------

Span

Specifies the span used to calculate the power in the reference channel.

Key Path:	Meas Setup, Ref Channel
Mode:	WCDMA, C2K, WIMAX OFDMA, TD-SCDMA, 1xEVDO, LTE, LTETDD, WLAN
Remote Command:	[:SENSE] :SEMAsk :FREQUency [1] 2 :SPAN <freq> [:SENSE] :SEMAsk :FREQUency [1] 2 :SPAN?
Example:	SEM:FREQ:SPAN 3MHz SEM:FREQ:SPAN?
Notes:	Frequency sub op code, 1 is for BTS, 2 for MS. Default is BTS. You must be in the mode that includes SEM measurement to use this command. Use :INSTrument:SELEct to set the mode.
Couplings:	Range 1 kHz to 50 MHz (although restricted by Integ BW). If you set the channel Span lower than channel Integ BW, they will both track each other. As you increase the channel Span, the Integ BW will also increase if it is less than 1/10 of the channel Span. For WLAN 802.11ac (80 + 80 MHz), the channel span is coupled with the difference between the center frequencies of the two carriers. When the difference is either less than 80 MHz or greater than 565 MHz, a “setting conflict” error message is displayed. Chan Span = Carrier Spacing + Chan IntegBW;

Spectrum Emission Mask Measurement
Meas Setup

Preset:	<p>WCDMA: 5.0 MHz 5.0 MHz</p> <p>C2K: 1.25 MHz 1.25 MHz</p> <p>WIMAX OFDMA: 10 MHz 10 MHz</p> <p>TD-SCDMA: 1.6 MHz 1.6 MHz</p> <p>1xEVDO: 1.25 MHz</p> <p>LTE: 5 MHz</p> <p>LTETDD: 5 MHz</p> <p>WLAN:</p> <p>if Radio Std is 802.11a/g(OFDM/DSSS-OFDM)/802.11n(20 MHz)/ 802.11ac (20 MHz): 18 MHz</p> <p>if Radio Std is 802.11b/g(DSSS/CCK/PBCC): 22 MHz</p> <p> if Radio Std is 802.11n(40MHz)/ 802.11ac (40 MHz): 38 MHz</p> <p> if Radio Std is 802.11ac (80 MHz): 78 MHz</p> <p> if Radio Std is 802.11ac (160 MHz): 158 MHz</p> <p> if Radio Std is 802.11ac (80 MHz + 80 MHz): 240 MHz</p>
State Saved:	Saved in instrument state.
Min:	1 kHz
Max:	645 MHz
Initial S/W Revision:	Prior to A.02.00
Modified at S/W Revision:	A.02.00, A.03.00
Help Map ID:	9015

Sweep Time

Sets the sweep time used to calculate the power in the reference channel. Sweep Time can be set manually or put in auto mode.

Key Path:	Meas Setup, Ref Channel
Mode:	WCDMA, C2K, WIMAX OFDMA, TD-SCDMA, 1xEVDO, LTE, LTETDD, WLAN
Remote Command:	<pre>[:SENSE] :SEMask:SWEep [1] 2:TIME <time> [:SENSE] :SEMask:SWEep [1] 2:TIME? [:SENSE] :SEMask:SWEep [1] 2:TIME:AUTO OFF 0 ON 1 [:SENSE] :SEMask:SWEep [1] 2:TIME:AUTO?</pre>

Example:	SEM:SWE:TIME 9ms SEM:SWE:TIME? SEM:SWE:TIME:AUTO OFF SEM:SWE:TIME:AUTO?
Notes:	Sweep Time sub op code, 1 is for BTS, 2 for MS. Default is BTS. You must be in the mode that includes SEM measurement to use this command. Use :INSTrument:SELEct to set the mode.
Couplings:	When the Sweep Time is set manually, Auto is set to OFF. Value is coupled with Channel Detector selection, Channel Resolution BW, Channel Video BW if the state is Auto. When set to Auto, the Sweep Time is automatically calculated
Preset:	Automatically calculated ON
State Saved:	Saved in instrument state.
Min:	1 ms
Max:	4000 s
Initial S/W Revision:	Prior to A.02.00
Modified at S/W Revision:	A.02.00, A.03.00
Help Map ID:	9016

Res BW

Sets the resolution bandwidth used to calculate the power in the reference channel. The Channel Resolution BW can be set manually or put in to auto mode.

Radio Format		RBW (kHz)
LTE	1.4 MHz	13
	3 MHz	27
	5 MHz	47
	10 MHz	91
	15 MHz	150
	20 MHz	180
W-CDMA		75
GSM		30

Spectrum Emission Mask Measurement
Meas Setup

Key Path:	Meas Setup, Ref Channel
Mode:	WCDMA, C2K, WIMAX OFDMA, TD-SCDMA, 1xEVDO, LTE, LTETDD, WLAN
Remote Command:	[:SENSe]:SEMAsk:BANDwidth[1] 2[:RESolution] <bandwidth> [:SENSe]:SEMAsk:BANDwidth[1] 2[:RESolution]? [:SENSe]:SEMAsk:BANDwidth[1] 2[:RESolution]:AUTO OFF ON 1 0 [:SENSe]:SEMAsk:BANDwidth[1] 2[:RESolution]:AUTO?
Example:	SEM:BAND 100 kHz SEM:BAND? SEM:BAND:AUTO ON SEM:BAND:AUTO?
Notes:	Bandwidth sub op code, 1 is for BTS, 2 for MS. Default is BTS. You must be in the mode that includes SEM measurement to use this command. Use :INSTrument:SELEct to set the mode.
Couplings:	When Res BW is set manually, Channel Resolution BW Mode is set to MANual. Value is coupled with Channel Detector selection, Channel Sweep Time, Channel Video BW. When set to Auto, the resolution bandwidth is automatically calculated.
Preset:	WCDMA: 75 kHz C2K: 24 kHz WIMAX OFDMA: 100 kHz TD-SCDMA: 30 kHz 1xEVDO: 30.0 KHz LTE, LTETDD: Auto (47 kHz) WLAN: 100 kHz ON
State Saved:	Saved in instrument state.
Min:	1 Hz
Max:	8 MHz
Backwards Compatibility SCPI:	[:SENSe]:SEMAsk:BWIDth[1] 2[:RESolution]
Initial S/W Revision:	Prior to A.02.00
Modified at S/W Revision:	A.02.00, A.03.00
Help Map ID:	9017

Video BW

Sets the video bandwidth used to calculate the power in the reference channel. The Channel Video BW can be set manually or put in to auto mode.

Key Path:	Meas Setup, Ref Channel
Mode:	WCDMA, C2K, WIMAX OFDMA, TD-SCDMA, 1xEVDO, LTE, LTETDD, WLAN
Remote Command:	[:SENSE]:SEMask:BANDwidth[1] 2:VIDeo <bandwidth> [:SENSE]:SEMask:BANDwidth[1] 2:VIDeo? [:SENSE]:SEMask:BANDwidth[1] 2:VIDeo:AUTO OFF ON 1 0 [:SENSE]:SEMask:BANDwidth[1] 2:VIDeo:AUTO?
Example:	SEM:BAND:VID 100 kHz SEM:BAND:VID? SEM:BAND:VID:AUTO ON SEM:BAND:VID:AUTO?
Notes:	Bandwidth sub op code, 1 is for BTS, 2 for MS. Default is BTS. You must be in the mode that includes SEM measurement to use this command. Use :INSTrument:SELEct to set the mode.
Couplings:	When Video BW is set manually, Channel Video BW Mode is set to MANual Value is coupled with Channel Detector selection, Channel Sweep Time, Channel Resolution BW. When set to Auto, the video bandwidth is automatically calculated.
Preset:	WCDMA: 75 kHz C2K: 24 kHz WIMAX OFDMA: 30 kHz TD-SCDMA: 300 kHz 1xEVDO: 300.0 kHz LTE: Auto LTETDD: Auto WLAN: Auto ON
State Saved:	Saved in instrument state.
Min:	1 Hz
Max:	50 MHz
Backwards Compatibility SCPI:	[:SENSe]:SEMask:BWIDth[1] 2:VIDeo
Initial S/W Revision:	Prior to A.02.00

Spectrum Emission Mask Measurement
Meas Setup

Modified at S/W Revision:	A.02.00, A.03.00
Help Map ID:	9007

VBW/RBW

Sets the Video BW/Resolution BW Ratio to calculate the Channel Resolution BW and Channel Video BW. The VBW/RBW Ratio can be set manually or put in to auto mode.

Key Path:	Meas Setup, Ref Channel
Mode:	WCDMA, C2K, WIMAX OFDMA, TD-SCDMA, 1xEVDO, LTE, LTETDD, WLAN
Remote Command:	[:SENSE] :SEMAsk:BA NDwidth [1] 2:VIDeo:RATio <real> [:SENSE] :SEMAsk:BA NDwidth [1] 2:VIDeo:RATio [:SENSE] :SEMAsk:BA NDwidth [1] 2:VIDeo:RATio:AUTO OFF ON 1 0 [:SENSE] :SEMAsk:BA NDwidth [1] 2:VIDeo:RATio:AUTO?
Example:	SEM:BA ND:VID:RAT 0.1 SEM:BA ND:VID:RAT? SEM:BA ND:VID:RAT:AUTO ON SEM:BA ND:VID:RAT:AUTO?
Notes:	Bandwidth sub op code, 1 is for BTS, 2 for MS. Default is BTS. You must be in the mode that includes SEM measurement to use this command. Use :INSTrument:SElect to set the mode.
Couplings:	When Res BW is set manually, Mode coupling is set to MANual When set to Auto, the VBW/RBW Ratio is automatically calculated.
Preset:	WCDMA, C2K: 1.0 WIMAX OFDMA: 0.3 TD-SCDMA: 10 1xEVDO: 10.0 LTE: Auto LTETDD: Auto WLAN: Auto ON
State Saved:	Saved in instrument state.
Min:	0.00001
Max:	3000000
Backwards Compatibility SCPI:	[:SENSe] :SEMAsk:BWIDth [1] 2:VIDeo:RATio

Initial S/W Revision:	Prior to A.02.00
Modified at S/W Revision:	A.02.00, A.03.00
Help Map ID:	9009

Power Ref

Sets the power reference in the carrier that will be used to compute the relative values for the offsets.

Key Path:	Meas Setup, Ref Channel
Initial S/W Revision:	Prior to A.02.00
Help Map ID:	9040

Total Power

Sets the power in the carrier (ref channel) that is used to compute the relative power values for the offsets. When the state is set to auto, this value is set to the measured carrier reference power. When set to manual, the result takes on the last measured value, or can be manually entered.

For WLAN 802.11ac (80 MHz + 80 MHz), the higher of the power readouts of the two carriers is used for computing the relative power values for the offset.

Key Path:	Meas Setup, Ref Channel, Power Ref
Mode:	WCDMA, C2K, WIMAX OFDMA, TD-SCDMA, 1xEVDO, LTE, LTETDD, WLAN
Remote Command:	[:SENSE]:SEMAsk:CARRier[:POWER] <real> [:SENSE]:SEMAsk:CARRier[:POWER]? [:SENSE]:SEMAsk:CARRier:AUTO[:STATE] OFF ON 1 0 [:SENSE]:SEMAsk:CARRier:AUTO[:STATE]?
Example:	SEM:CARR 100dBm SEM:CARR? SEM:CARR:AUTO OFF SEM:CARR:AUTO?
Notes:	The min and max values given are for Meas Type = Total Pwr Ref. You must be in the mode that includes SEM measurement to use this command. Use :INSTrument:SELEct to set the mode.. This BAF SCPI command is available in all the Meas Type case.
Dependencies:	This "Total Power Ref" parameter is coupled with the "Meas Type" parameter. The softkey would be active if the Meas Type is set to Total Power Ref. Otherwise, it is grayed out.
Preset:	Measured carrier reference power

Spectrum Emission Mask Measurement
Meas Setup

State Saved:	Saved in instrument state.
Min:	-200 dBm
Max:	200 dBm
Initial S/W Revision:	Prior to A.02.00
Modified at S/W Revision:	A.02.00, A.03.00
Help Map ID:	9018

PSD

Sets the power spectral density in the carrier that is used to compute the relative power spectral density values for the offsets when Meas Type is set to PSD Ref. When the state is set to auto, this will be set to the measured carrier power spectral density.

For WLAN 802.11ac (80 MHz + 80 MHz), the higher of the power density readouts of the two carriers is used for computing the relative PSD values for the offset.

Key Path:	Meas Setup, Ref Chan, Power Ref
Mode:	WCDMA, C2K, WIMAX OFDMA, TD-SCDMA, 1xEVDO, LTE, LTETDD, WLAN
Remote Command:	[:SENSE] :SEMAsk:CARRier:CPSD <real> [:SENSE] :SEMAsk:CARRier:CPSD?
Example:	SEM:CARR:CPSD -80 SEM:CARR:CPSD?
Notes:	Although the default value is defined, the value is recalculated by the measurement result just after completing the measurement. Carrier sub op code. 1 for BTS, 2 for MS. Default is BTS. You must be in the mode that includes SEM measurement to use this command. Use :INSTRument:SELect to set the mode.
Dependencies:	See Couplings
Couplings:	This "PSD" parameter is coupled with the "Meas Type" parameter. The key will be active if the Meas Type is set to PSD. Otherwise, it is grayed out.
Preset:	Measured carrier PSD reference power
State Saved:	Saved in instrument state.
Min:	-200
Max:	200
Initial S/W Revision:	Prior to A.02.00
Modified at S/W Revision:	A.02.00, A.03.00
Help Map ID:	9064

Spectrum Peak

Sets the spectrum peak power in the carrier that is used to compute the relative power spectral density values for the offsets when Meas Type is set to Spectrum Peak. When the state is set to auto, this is set to the measured carrier spectrum peak power. When set to manual, the result takes on the last measured value, or can be manually entered

Key Path:	Meas Setup, Ref Channel, Power Ref
Mode:	WCDMA, C2K , WIMAX OFDMA, TD-SCDMA, 1xEVDO, LTE, LTETDD, WLAN
Remote Command:	[:SENSE] :SEMAsk:CARRier:PEAK[:POWer] <real> [:SENSE] :SEMAsk:CARRier:PEAK[:POWer] ?
Example:	SEM:CARR:PEAK -80 SEM:CARR:PEAK:POWER?
Notes:	Although the default value is defined, the value is recalculated by the measurement result just after completing the measurement. Carrier sub op code. 1 for BTS, 2 for MS. Default is BTS. You must be in the mode that includes SEM measurement to use this command. Use :INSTrument:SELect to set the mode.
Dependencies:	See Couplings
Couplings:	This "Spectrum Peak Ref" parameter is coupled with the "Meas Type" parameter. This softkey would be active if the "Meas Type" is set to "Spectrum Peak Ref". Otherwise, grayout.
Preset:	Measured carrier Spectrum Peak reference power
State Saved:	Saved in instrument state.
Min:	-200
Max:	200
Initial S/W Revision:	Prior to A.02.00
Modified at S/W Revision:	A.02.00, A.03.00
Help Map ID:	9010

Offset/Limits

Accesses a menu that enables you to set up the measurement parameters for offset pairs. For example, you can assign the start and stop frequencies, select the resolution bandwidth, and set the sweep time.

Key Path:	Meas Setup
Initial S/W Revision:	Prior to A.02.00
Help Map ID:	9065

Spectrum Emission Mask Measurement
Meas Setup

Select Offset

Selects the offset (upper and lower) and displays the memory selection menu that enables you to store a set of parameter values for the offset, such as Start Freq, Stop Freq, Sweep Time, Res BW, Meas BW, Abs Start, and Abs Stop. Only one selection at a time is shown on this menu key label.

Key Path:	Meas Setup, Offset/Limits
Mode:	WCDMA, C2K, WIMAX OFDMA, TD-SCDMA, 1xEVDO, LTE, LTETDD, WLAN
Preset:	A
Range:	WLAN: A B C D E F G H I J K L
Initial S/W Revision:	Prior to A.02.00
Modified at S/W Revision:	A.02.00, A.03.00, A.10.00, A.11.00
Help Map ID:	9019

Start Freq

Specifies the start frequency for the currently selected offset and enables you to toggle this function On or Off for each offset.

Key Path:	Meas Setup, Offset/Limits
Mode:	WCDMA, C2K, WIMAX OFDMA, TD-SCDMA, 1xEVDO, LTE, LTETDD, WLAN
Remote Command:	[:SENSe]:SEMask:OFFSet [1] 2:LIST:FREQuency:STARt <freq>, ... [:SENSe]:SEMask:OFFSet [1] 2:LIST:FREQuency:STARt? [:SENSe]:SEMask:OFFSet [1] 2:LIST:STATe ON OFF 1 0, ... [:SENSe]:SEMask:OFFSet [1] 2:LIST:STATe?
Example:	SEM:OFFS2:LIST:FREQ:STAR 2.515 MHz, 2.715 MHz, 3.515 MHz, 4.00 MHz, 8.00 MHz, 12.50 MHz SEM:OFFS2:LIST:FREQ:STAR? SEM:OFFS:LIST:STAT ON, ON, ON, OFF, OFF, OFF SEM:OFFS:LIST:STAT?
Notes:	Comma separated list of values. OFFSet1 is for BTS, 2 for MS. Default is BTS. You must be in the mode that includes SEM measurement to use this command. Use :INSTrument:SELEct to set the mode.
Couplings:	Coupled to Stop Freq. Start cannot go above the stop freq less 100Hz. Similarly Stop freq cannot go below Start Freq plus 100Hz.

Preset:	<p>For modes (except WLAN), the preset value is as follows.</p> <p>WCDMA: 2.515 MHz, 2.715 MHz, 3.515 MHz, 4.000 MHz, 8.000 MHz, 12.50 MHz 2.515MHz, 4.000 MHz, 7.500 MHz, 8.500 MHz, 12.5 MHz, 15 MHz</p> <p>C2K: 750.0 kHz, 780.0 kHz, 1.980 MHz, 3.25 MHz, 7.0 MHz, 7.0 MHz 885 kHz, 1.980 MHz, 2.250 MHz, 8.0 MHz, 12.0 MHz, 12.0 MHz</p> <p>WIMAX OFDMA: 4.75 MHz,5.45 MHz,9.75 MHz,14.75 MHz,19.75 MHz,24.75 MHz 4.75 MHz,5.45 MHz,9.75 MHz,14.75 MHz,19.75 MHz,24.75 MHz</p> <p>TD-SCDMA:</p> <p>81 5kHz,1015 kHz,1815 kHz,2.3 MHz, ,2.3 MHz,,2.3 MHz 815 kHz,1.8 MHz,2.9 MHz, 2.9 MHz,2.9 MHz, 2.9 MHz</p> <p>1xEVDO: 750.0 kHz, 780.0 kHz, 1.98 MHz, 3.25 MHz, 7 MHz, 7 MHz 885.0 kHz, 1.98 MHz, 1.98 MHz , 1.98 MHz, 1.98 MHz, 1.98 MHz</p> <p>LTE, LTETDD: 50 kHz, 5.05 MHz, 10.5 MHz, 15.00 MHz, 30 MHz, 40 MHz 15.00 kHz,1.5 MHz,5.5 MHz,6.5 MHz,10 MHz,20MHz</p> <p>-----</p> <p>WLAN:</p> <p>if Radio Std is 802.11a/g(OFDM/DSSS-OFDM)/802.11n(20MHz): 9 MHz, 11 MHz, 20 MHz, 30 MHz, 50 MHz, 216 MHz, 216 MHz, 216 MHz, 216 MHz, 216 MHz, 216 MHz</p> <p>if Radio Std is 802.11b/g(DSSS/CCK/PBCC): 11 MHz, 22 MHz, 50 MHz, 70 MHz, 90 MHz, 100 MHz , 100 MHz, 100 MHz, 100 MHz, 100 MHz, 100 MHz</p> <p>if Radio Std is 802.11n(20MHz): 9 MHz, 11 MHz, 20 MHz, 30 MHz, 50 MHz, 100 MHz, 100 MHz, 100 MHz, 100 MHz, 100 MHz, 100 MHz, 100 MHz</p> <p>if Radio Std is 802.11n(40MHz): 19 MHz, 21 MHz, 40 MHz, 60 MHz, 100 MHz, 200 MHz, 200 MHz, 200 MHz, 200 MHz, 200 MHz, 200 MHz, 200 MHz</p> <p>if Radio Std is 802.11ac(20MHz): 9 MHz, 11 MHz, 20 MHz, 30 MHz, 30 MHz, 30 MHz, 30 MHz, 30 MHz, 30 MHz, 30 MHz, 30 MHz, 30 MHz</p> <p>if Radio Std is 802.11ac(40MHz): 19 MHz, 21 MHz, 40 MHz, 60 MHz, 60 MHz, 60 MHz, 60 MHz, 60 MHz, 60 MHz, 60 MHz, 60 MHz, 60 MHz</p> <p>if Radio Std is 802.11ac(80MHz): 39 MHz, 41 MHz, 80 MHz, 120 MHz, 120 MHz, 120 MHz, 120 MHz, 120 MHz, 120 MHz, 120 MHz, 120 MHz, 120 MHz</p> <p>if Radio Std is 802.11ac(160MHz): 79 MHz, 81 MHz, 160 MHz, 240 MHz, 240 MHz, 240 MHz, 240 MHz, 240 MHz, 240 MHz, 240 MHz, 240 MHz, 240 MHz</p> <p>if Radio Std is 802.11ac(80 MHz + 80MHz): 0 MHz, 40 MHz, 79 MHz, 159 MHz, 161 MHz, 200 MHz, 240 MHz, 240 MHz, 240 MHz, 240 MHz, 240 MHz, 240 MHz</p>
---------	--

Spectrum Emission Mask Measurement
Meas Setup

Preset: (Cont)	For modes (except WLAN), the preset value is as follows. WCDMA: ON, ON, ON, ON, ON, OFF ON, ON, ON, ON, OFF, OFF C2K: ON, ON, ON, OFF, OFF, OFF ON, ON, OFF, OFF, OFF, OFF WIMAX OFDMA: ON, ON, ON, OFF, OFF, OFF ON, ON, ON, OFF, OFF, OFF TD-SCDMA: ON, ON, ON, ON, OFF, OFF ON, ON, ON, OFF, OFF, OFF 1xEVDO: ON, ON, ON, OFF, OFF, OFF ON, ON, OFF, OFF, OFF, OFF LTE, LTETDD: ON, ON, ON, OFF, OFF, OFF ON,ON,ON,ON,OFF,OFF ----- WLAN: if Radio Std is 802.11a/g(OFDM/DSSS-OFDM)/802.11n(20MHz/40MHz): ON, ON, ON, ON, OFF, OFF, OFF, OFF, OFF, OFF, OFF, OFF if Radio Std is 802.11ac (20 MHz/ 40 MHz/ 80 MHz/ 160 MHz): ON, ON, ON, ON, OFF, OFF, OFF, OFF, OFF, OFF, OFF, OFF if Radio Std is 802.11ac (80 MHz + 80 MHz): ON, ON, ON, ON, ON, ON, ON, OFF, OFF, OFF, OFF, OFF
State Saved:	Saved in instrument state.
Min:	0 Hz
Max:	Stop Freq minus (-) 100 Hz (for that offset)
Initial S/W Revision:	Prior to A.02.00
Modified at S/W Revision:	A.02.00, A.03.00, A.10.00, A.11.00
Help Map ID:	9020

Stop Freq

Specifies the stop frequency for the currently selected offset.

Key Path:	Meas Setup, Offset/Limits
Mode:	WCDMA, C2K, WIMAX OFDMA, TD-SCDMA, 1xEVDO, LTE, LTETDD, WLAN
Remote Command:	[:SENSe] :SEMAsk:OFFSet [1] 2:LIST:FREQuency:STOP <freq>, ... [:SENSe] :SEMAsk:OFFSet [1] 2:LIST:FREQuency:STOP?
Example:	SEM:OFFS:LIST:FREQ:STOP 2.715 MHz, 3.515 MHz, 4.00 MHz, 8.00 MHz, 12.50 MHz, 15.0 MHz SEM:OFFS:LIST:FREQ:STOP?

Notes:	Comma separated list of values. OFFSet1 is for BTS, 2 for MS. Default is BTS. You must be in the mode that includes SEM measurement to use this command. Use :INSTrument:SElect to set the mode.
Couplings:	Coupled to Start Freq. Start cannot go above the stop freq less 100Hz. Similarly Stop freq cannot go below Start Freq plus 100Hz.

Spectrum Emission Mask Measurement
 Meas Setup

<p>Preset:</p>	<p>For modes (except WLAN), the preset value is as follows.</p> <p>WCDMA: 2.715 MHz, 3.515 MHz, 4.000 MHz, 8.000 MHz, 12.50 MHz, 15.0 MHz 3.485 MHz, 7.500 MHz, 8.500 MHz, 12.00 MHz, 15.00 MHz, 18.0 MHz</p> <p>C2K: 780.0 kHz, 1.980 MHz, 4.0 MHz, 4.0 MHz, 12.0 MHz, 12.0 MHz 1.980 MHz, 4.0 MHz, 4.0 MHz, 11.5 MHz, 14.5 MHz, 14.5 MHz</p> <p>WIMAX OFDMA: 5.45 MHz, 9.75 MHz, 14.75 MHz, 19.75 MHz, 24.75 MHz, 29.75 MHz 5.45 MHz, 9.75 MHz, 14.75 MHz, 19.75 MHz, 24.75 MHz, 29.75 MHz</p> <p>TD-SCDMA:</p> <p>1015 kHz, 1815 kHz, 2.3 MHz, 4 MHz, 4 MHz, 4 MHz 1.8 MHz, 2385 kHz, 3.5 MHz, 3.5 MHz, 3.5 MHz, 3.5 MHz</p> <p>1xEVDO: 780.0 kHz, 1.98 MHz, 4.0 MHz, 4.0 MHz, 12 MHz, 12 MHz 1.98 MHz, 4.0 MHz, 4.0 MHz, 4.0 MHz, 4.0 MHz, 4.0 MHz</p> <p>LTE, LTE-TDD: 5.05 MHz, 10.05 MHz, 15 MHz, 30 MHz, 40 MHz, 50 MHz 985.0 kHz, 4.50 MHz, 5.5001 MHz, 9.50 MHz, 20 MHz, 40 MHz</p> <p>-----</p> <p>WLAN:</p> <p>if Radio Std is 802.11a/g(OFDM/DSSS-OFDM)/802.11n(20MHz): 11 MHz, 20 MHz, 30 MHz, 50 MHz, 100 MHz, 250 MHz, 250 MHz, 250 MHz, 250 MHz, 250 MHz, 250 MHz, 250 MHz</p> <p>if Radio Std is 802.11b/g(DSSS/CCK/PBCC): 22 MHz, 50 MHz, 70 MHz, 90 MHz, 100 MHz, 120 MHz, 120 MHz, 120 MHz, 120 MHz, 120 MHz, 120 MHz, 120 MHz</p> <p>if Radio Std is 802.11n(20MHz): 11 MHz, 20 MHz, 30 MHz, 50 MHz, 100 MHz, 200 MHz, 200 MHz, 200 MHz, 200 MHz, 200 MHz, 200 MHz, 200 MHz</p> <p>if Radio Std is 802.11n(40MHz): 21 MHz, 40 MHz, 60 MHz, 100 MHz, 200 MHz, 300 MHz, 300 MHz, 300 MHz, 300 MHz, 300 MHz, 300 MHz, 300 MHz</p> <p>if Radio Std is 802.11ac(20MHz): 11 MHz, 20 MHz, 30 MHz, 50 MHz, 50 MHz, 50 MHz, 50 MHz, 50 MHz, 50 MHz, 50 MHz, 50 MHz, 50 MHz</p> <p>if Radio Std is 802.11ac(40MHz): 21 MHz, 40 MHz, 60 MHz, 100 MHz, 100 MHz, 100 MHz, 100 MHz, 100 MHz, 100 MHz, 100 MHz, 100 MHz, 100 MHz</p> <p>if Radio Std is 802.11ac(80MHz): 41 MHz, 80 MHz, 120 MHz, 200 MHz, 200 MHz, 200 MHz, 200 MHz, 200 MHz, 200 MHz, 200 MHz, 200 MHz, 200 MHz</p> <p>if Radio Std is 802.11ac(160MHz): 81 MHz, 160 MHz, 240 MHz, 400 MHz, 400 MHz, 400 MHz, 400 MHz, 400 MHz, 400 MHz, 400 MHz, 400 MHz, 400 MHz</p> <p>if Radio Std is 802.11ac(80 MHz + 80MHz): 40 MHz, 79 MHz, 81 MHz, 161 MHz, 200 MHz, 240 MHz, 260 MHz, 260 MHz, 260 MHz, 260 MHz, 260 MHz, 260 MHz</p>
----------------	--

State Saved:	Saved in instrument state.
Min:	Start Freq plus (+) 100 Hz (for that offset)
Max:	500 MHz
Initial S/W Revision:	Prior to A.02.00
Modified at S/W Revision:	A.02.00, A.03.00, A.10.00, A.11.00
Help Map ID:	9021

Sweep Time

Specifies the sweep time for the currently selected offset and enables you to toggle this function On or Off for each offset.

Key Path:	Meas Setup, Offset/Limits
Mode:	WCDMA, C2K, WIMAX OFDMA, TD-SCDMA, 1xEVDO, LTE, LTETDD, WLAN
Remote Command:	[:SENSE]:SEMAsk:OFFSet [1] 2:LIST:SWEep:TIME <time>, ... [:SENSE]:SEMAsk:OFFSet [1] 2:LIST:SWEep:TIME? [:SENSE]:SEMAsk:OFFSet [1] 2:LIST:SWEep:TIME:AUTO ON OFF 1 0, ... [:SENSE]:SEMAsk:OFFSet [1] 2:LIST:SWEep:TIME:AUTO?
Example:	SEM:OFFS2:LIST:SWE:TIME 1.0 ms, 3.4 ms, 2.08 ms, 1.0 ms, 1.0 ms, 1.0 ms SEM:OFFS2:LIST:SWE:TIME? SEM:OFFS2:LIST:SWE:TIME:AUTO ON, ON, ON, ON, OFF, OFF SEM:OFFS2:LIST:SWE:TIME:AUTO?
Notes:	Comma separated list of values. OFFSet1 is for BTS, 2 for MS. Default is BTS. You must be in the mode that includes SEM measurement to use this command. Use :INSTrument:SELEct to set the mode.
Couplings:	When the sweep time is set manually, Mode coupling is set to MANUAL
Preset:	Automatically calculated Modes (except WLAN): ON,ON,ON,ON,ON,ON WLAN: ON,ON,ON,ON,ON,ON,ON,ON,ON,ON,ON,ON
State Saved:	Saved in instrument state.
Min:	1 ms
Max:	10 s
Backwards Compatibility SCPI:	[:SENSe]:SEMAsk:OFFSet[1] 2:LIST:SWEep[:TIME]

Spectrum Emission Mask Measurement
Meas Setup

Initial S/W Revision:	Prior to A.02.00
Modified at S/W Revision:	A.02.00, A.03.00, A.10.00, A.11.00
Help Map ID:	9025

Offset Side

Specifies which offset side to measure.

You can turn off (not use) specific offsets with [:SENSe]:SEMAsk:OFFSet[n]:LIST:STATe.

- **BOTH** - both of the negative (lower) and positive (upper) sidebands
- **NEGative** - negative (lower) sideband only
- **POSitive** - positive (upper) sideband only

Key Path:	Meas Setup, Offset/Limits
Mode:	WCDMA, C2K, WIMAX OFDMA, TD-SCDMA, 1xEVDO, LTE, LTETDD, WLAN
Remote Command:	[:SENSe]:SEMAsk:OFFSet [1] 2:LIST:SIDE BOTH NEGative POSitive, ... [:SENSe]:SEMAsk:OFFSet [1] 2:LIST:SIDE?
Example:	SEM:OFFS:LIST:SIDE BOTH, NEG, NEG, POS, POS, POS SEM:OFFS:LIST:SIDE?
Notes:	Comma separated list of values. OFFSet1 is for BTS, 2 for MS. Default is BTS. You must be in the mode that includes SEM measurement to use this command. Use :INSTrument:SELEct to set the mode.
Preset:	Modes (except WLAN): BOTH, BOTH, BOTH, BOTH, BOTH, BOTH WLAN: BOTH, BOTH, BOTH, BOTH, BOTH, BOTH, BOTH, BOTH, BOTH, BOTH, BOTH, BOTH
State Saved:	Saved in instrument state.
Range:	Neg Both Pos
Initial S/W Revision:	Prior to A.02.00
Modified at S/W Revision:	A.02.00, A.03.00, A.10.00, A.11.00
Help Map ID:	9023

Res BW

Specifies which Resolution BW filter to use when measuring the currently selected offset.

Offset Res BW Mode allows the instrument to determine the optimum Resolution BW filter to use when measuring the currently selected offset.. When changing the Meas BW parameter, if the Res BW needs

to be changed to adhere to the rule

$(N \times \text{Res BW}) \leq (\text{Stop freq of the offset} - \text{Start freq of the offset})$,

where N is the multiplier, this setting will automatically be changed to manual.

Key Path:	Meas Setup, Offset/Limits
Mode:	WCDMA, C2K, WIMAX OFDMA, TD-SCDMA, 1xEVDO, LTE, LTETDD, WLAN
Remote Command:	<pre>[:SENSE]:SEMask:OFFSet [1] 2:LIST:BANDwidth[:RESolution] <bandwidth>, ... [:SENSE]:SEMask:OFFSet [1] 2:LIST:BANDwidth[:RESolution] ? [:SENSE]:SEMask:OFFSet [1] 2:LIST:BANDwidth[:RESolution] :AUTO OFF ON 1 0, ... [:SENSE]:SEMask:OFFSet [1] 2:LIST:BANDwidth[:RESolution] :AUTO?</pre>
Example:	<pre>SEM:OFFS2:LIST:BAND 30.0 kHz, 30.0 kHz, 30.0 kHz, 1.00 MHz,1.00 MHz, 1.00 MHz SEM:OFFS2:LIST:BAND? SEM:OFFS:LIST:BAND:AUTO 1,1,1,1,1,1 SEM:OFFS:LIST:BAND:AUTO?</pre>
Notes:	<p>Comma separated list of values.</p> <p>OFFSet1 is for BTS, 2 for MS. Default is BTS.</p> <p>You must be in the mode that includes SEM measurement to use this command. Use :INSTrument:SElect to set the mode.</p>
Couplings:	<p>Coupled to Start and Stop offset and Meas BW multiplier. This parameter must adhere to the rule $(N \times \text{Res BW}) \leq (\text{Stop freq of the offset} - \text{Start freq of the offset})$, where N is the multiplier. If the multiplier is changed, the Res BW will be changed to ensure this. When set manually, Res BW Coupling is set to manual.</p>

Spectrum Emission Mask Measurement
Meas Setup

Preset:	<p>For modes (except WLAN), the preset value is as follows.</p> <p>WCDMA: 30.00 kHz, 30.00 kHz, 30.00 kHz, 100.00 kHz, 1.000 MHz, 1.00 MHz 30.00 kHz, 1.000 MHz, 1.000 MHz, 1.000 MHz, 1.000 MHz, 1.00 MHz</p> <p>C2K: 3.00 kHz, 30.00 kHz, 30.00 kHz, 6.2 kHz, 1.000 MHz, 1.00 MHz 30.00 kHz, 30.00 kHz, 6.2 kHz, 1.000 MHz, 1.000 MHz, 1.00 MHz</p> <p>WIMAX OFDMA: 100 KHz, 100 KHz, 100 KHz, 100 KHz, 100 KHz, 100 KHz 100 KHz, 100 KHz, 100 KHz, 100 KHz, 100 KHz, 100 KHz</p> <p>TD-SCDMA: 30 kHz, 30 kHz, 30 kHz, 50 kHz, 1 MHz, 1 MHz 30 kHz, 30 kHz, 50 kHz, 1 MHz, 1 MHz, 1 MHz</p> <p>1xEVDO: 30.00 kHz, 30.00 kHz, 30.00 kHz, 6.2 kHz, 1.000 MHz, 1.000 MHz 30.00 kHz, 30.00 kHz, 30.00 kHz, 30.00 kHz, 30.00 kHz, 30.00 kHz</p> <p>LTE, LTETDD: 51 kHz, 100 kHz, 1.0 MHz, 1.0 MHz, 1.0 MHz, 1.0 MHz 15.0 kHz, 510 kHz, 1.0 MHz, 1.0 MHz, 1.0 MHz, 1.0 MHz</p> <p>-----</p> <p>WLAN: 100 KHz, 100 KHz, 100 KHz, 100 KHz, 100 KHz, 100 KHz, 100 KHz, 100 KHz, 100 KHz, 100 KHz, 100 KHz</p> <p>Modes (except WLAN): OFF, OFF, OFF, OFF, OFF, OFF OFF, OFF, OFF, OFF, OFF, OFF</p> <p>WLAN: OFF, OFF, OFF, OFF, OFF, OFF, OFF, OFF, OFF, OFF, OFF, OFF OFF, OFF, OFF, OFF, OFF, OFF, OFF, OFF, OFF, OFF, OFF, OFF</p>
State Saved:	Saved in instrument state.
Min:	1 Hz
Max:	8 MHz
Backwards Compatibility SCPI:	[[:SENSe]:SEMAsk:OFFSet[1]] 2:LIST:BWIDth[:RESolution]
Initial S/W Revision:	Prior to A.02.00
Modified at S/W Revision:	A.02.00, A.03.00, A.10.00, A.11.00
Help Map ID:	9026

Meas BW

Allows you to specify a multiplier of Res BW for the measurement integration bandwidth.

Meas BW is multiplier integer number. It shows a ratio between Integration BW and Resolution BW of the measurement result.

$$\text{Integ BW} = \text{Meas BW} * \text{Resolution BW}$$

Integration BW is desired resolution bandwidth and Resolution BW is actual bandwidth for sweep. Measurement sweeps with Resolution BW and Meas BW compensates sweep resolution bandwidth to Integration BW.

If you set this parameter greater than 1, you can set Resolution BW narrower to avoid carrier power

leakage effect to the offset power integration.

Key Path:	Meas Setup, Offset/Limits
Mode:	WCDMA, C2K, WIMAX OFDMA, TD-SCDMA, 1xEVDO, LTE, LTETDD, WLAN
Remote Command:	[:SENSE] :SEMAsk:OFFSet [1] 2 :LIST:BAWdwidth:IMULti <integer>, ... [:SENSE] :SEMAsk:OFFSet [1] 2 :LIST:BAWdwidth:IMULti?
Example:	SEM:OFFS2:LIST:BAWd:IMUL 1,1,1,1,1 SEM:OFFS2:LIST:BAWd:IMUL?
Notes:	Comma separated list of values. OFFSet1 is for BTS, 2 for MS. Default is BTS. You must be in the mode that includes SEM measurement to use this command. Use :INSTrument:SELEct to set the mode.
Couplings:	This parameter must adhere to the rule (N x Res BW) <= (Stop freq of the offset - Start freq of the offset), where N is the multiplier. If the Res Bw is changed, the multiplier will be changed to ensure this.
Preset:	For modes (except WLAN), the preset value is as follows. WCDMA: 1, 1, 1, 10, 1, 1 1, 1, 1, 1, 1 C2K: 10, 1, 1, 1, 1, 1 1, 1, 1, 1, 1 WIMAX OFDMA, 1xEVDO: 1, 1, 1, 1, 1, 1 1, 1, 1, 1, 1 TD-SCDMA:1, 1, 1, 20, 1, 1 1, 1, 20, 1, 1, 1 LTE, LTETDD: 2, 1, 1, 1, 1, 1 2, 2, 1, 1, 1, 1 ----- WLAN: 1, 1, 1, 1, 1, 1, 1, 1, 1, 1, 1
State Saved:	Saved in instrument state.
Min:	1
Max:	1000
Backwards Compatibility SCPI:	[:SENSe] :SEMAsk:OFFSet[1] 2:LIST:BWIDth:IMULti
Initial S/W Revision:	Prior to A.02.00
Modified at S/W Revision:	A.02.00, A.03.00, A.10.00, A.11.00
Help Map ID:	9024

Video BW

Changes the analyzer post-detection filter.

Key Path:	Meas Setup, Offset/Limits
-----------	----------------------------------

Spectrum Emission Mask Measurement
Meas Setup

Mode:	WCDMA, C2K, WIMAX OFDMA, TD-SCDMA, 1xEVDO, LTE, LTETDD, WLAN
Remote Command:	[:SENSe] :SEMAsk:OFFSet [1] 2 :LIST:BAWdwidth:VIDeo <freq>, ... [:SENSe] :SEMAsk:OFFSet [1] 2 :LIST:BAWdwidth:VIDeo? [:SENSe] :SEMAsk:OFFSet [1] 2 :LIST:BAWdwidth:VIDeo:AUTO OFF ON 0 1, ... [:SENSe] :SEMAsk:OFFSet [1] 2 :LIST:BAWdwidth:VIDeo:AUTO?
Example:	SEM:OFFS2:LIST:BAND:VID 3.00 kHz, 3.00 kHz, 3.00 kHz, 100.0 kHz, 100.0 kHz, 100.0 kHz SEM:OFFS2:LIST:BAND:VID? SEM:OFFS2:LIST:BAND:VID:AUTO ON, ON, ON, ON, ON, ON SEM:OFFS2:LIST:BAND:VID:AUTO?
Notes:	Comma separated list of values. OFFSet1 is for BTS, 2 for MS. Default is BTS. You must be in the mode that includes SEM measurement to use this command. Use :INSTrument:SELEct to set the mode.
Preset:	Modes (except WLAN): ON, ON, ON, ON, ON, ON ON, ON, ON, ON, ON, ON ----- WLAN: ON, ON, ON, ON, ON, ON, ON, ON, ON, ON, ON, ON ON, ON, ON, ON, ON, ON, ON, ON, ON, ON, ON
State Saved:	Saved in instrument state.
Min:	1 Hz
Max:	50 MHz
Backwards Compatibility SCPI:	[:SENSe] :SEMAsk:OFFSet[1] 2:LIST:BWIDth:VIDeo
Initial S/W Revision:	Prior to A.02.00
Modified at S/W Revision:	A.02.00, A.03.00, A.10.00, A.11.00
Help Map ID:	9027

VBW/RBW

Selects the ratio between the video and resolution bandwidths.

Key Path:	Meas Setup, Offset/Limits
Mode:	WCDMA, C2K, WIMAX OFDMA, TD-SCDMA, 1xEVDO, LTE, LTETDD, WLAN

Remote Command:	<pre>[:SENSe] :SEMAsk:OFFSet [1] 2:LIST:BANDwidth:VIDeo:RATio <real>, ... [:SENSe] :SEMAsk:OFFSet [1] 2:LIST:BANDwidth:VIDeo:RATio? [:SENSe] :SEMAsk:OFFSet [1] 2:LIST:BANDwidth:VIDeo:RATio: AUTO OFF ON 0 1, ... [:SENSe] :SEMAsk:OFFSet [1] 2:LIST:BANDwidth:VIDeo:RATio: AUTO?</pre>
Example:	<pre>SEM:OFFS2:LIST:BAND:VID:RAT 0.1, 0.1, 0.1, 0.1, 0.1, 0.1 SEM:OFFS2:LIST:BAND:VID:RAT? SEM:OFFS2:LIST:BAND:VID:RAT:AUTO ON, ON, ON, ON, ON, ON SEM:OFFS2:LIST:BAND:VID:RAT:AUTO?</pre>
Notes:	<p>Comma separated list of values.</p> <p>OFFSet1 is for BTS, 2 for MS. Default is BTS.</p> <p>You must be in the mode that includes SEM measurement to use this command. Use :INSTrument:SELEct to set the mode.</p>
Preset:	<p>For modes (except WLAN), the preset value is as follows.</p> <p>WCDMA, C2K, LTE, LTETDD: 0.01, 0.01, 0.01, 0.01, 0.01, 0.01 0.01, 0.01, 0.01, 0.01, 0.01, 0.01</p> <p>WIMAX OFDMA: 0.3, 0.3, 0.3, 0.3, 0.3, 0.3</p> <p>TD-SCDMA: 10, 10, 10, 10, 1, 1 10, 10, 10, 1, 1, 1</p> <p>1xEVDO: 10, 10, 10, 10, 10, 10 10, 10, 10, 10, 10, 10</p> <p>-----</p> <p>WLAN: 0.3, 0.3, 0.3, 0.3, 0.3, 0.3, 0.3, 0.3, 0.3, 0.3, 0.3, 0.3, 0.3</p> <p>Modes (except WLAN): OFF, OFF, OFF, OFF, OFF, OFF OFF, OFF, OFF, OFF, OFF, OFF</p> <p>WLAN: OFF, OFF, OFF, OFF, OFF, OFF, OFF, OFF OFF, OFF, OFF, OFF, OFF, OFF, OFF, OFF</p>
State Saved:	Saved in instrument state.
Min:	0.00001
Max:	3000000
Initial S/W Revision:	Prior to A.02.00
Modified at S/W Revision:	A.02.00, A.03.00, A.10.00, A.11.00
Help Map ID:	9028

Spectrum Emission Mask Measurement
Meas Setup

Limits

Accesses a menu that enables you to set the power limits for start and stop frequencies of the selected offsets.

Key Path:	Meas Setup
Initial S/W Revision:	Prior to A.02.00
Help Map ID:	9066

Abs Start

Sets the absolute power level limit at the start frequency for the selected offset. The absolute power level limit ranges from -200 to +50 dBm.

The fail condition for each offset channel is set remotely by [:SENSE]:SEMask:OFFSet[n]:LIST:TEST.

You can turn off (not use) specific offset channels remotely with [:SENSE]:SEMask:OFFSet[n]:LIST:STATe.

The SCPI query returns the five (5) sets of real values currently set to the absolute power test limits.

Key Path:	Meas Setup, Offset/Limit, Limits
Mode:	WCDMA, C2K, WIMAX OFDMA, TD-SCDMA, 1xEVDO, LTE, LTETDD, WLAN
Remote Command:	[:SENSE]:SEMask:OFFSet [1] 2:LIST:STARt:ABSolute <real>, ... [:SENSE]:SEMask:OFFSet [1] 2:LIST:STARt:ABSolute?
Example:	SEM:OFFS2:LIST:STAR:ABS -12.50 dBm, -12.50 dBm, -24.50 dBm, -11.50 dBm, -11.50 dBm, -11.50 dBm SEM:OFFS2:LIST:STAR:ABS?
Notes:	Comma separated list of values. OFFSet1 is for BTS, 2 for MS. Default is BTS. You must be in the mode that includes SEM measurement to use this command. Use :INSTRument:SElect to set the mode.
Couplings:	Coupled to Abs Stop if coupling set to "Couple", that is, the Start value is equal to the Stop value.

Preset:	<p>For modes (except WLAN), the preset value is as follows.</p> <p>WIMAX OFDMA: -14.00 dBm , -14.00 dBm , -26.00 dBm , -13.00 dBm , -13.00 dBm, -13.00 dBm</p> <p>WCDMA: -12.50 dBm, -12.50 dBm, -24.50 dBm, -11.50 dBm, -11.50 dBm, -11.50 dBm -69.6 dBm, -54.3 dBm, -54.3 dBm, -54.3 dBm, -54.3 dBm, -54.3 dBm</p> <p>C2K: -27.00 dBm, -27.00 dBm, -27.00 dBm, -46.00 dBm, -13.00 dBm, -13.00 dBm -70.13 dBm, -70.13 dBm, -35.00 dBm, -13.00 dBm, -13.00 dBm, -13.00 dBm</p> <p>TD-SCDMA: -28 dBm, -28 dBm, -36 dBm, -21 dBm, -21 dBm, -21 dBm -71.3 dBm, -71.3 dBm, -56.07 dBm, -56.07 dBm, -56.07 dBm, -56.07 dBm</p> <p>1xEVDO: -27.0dBm, -27.00 dBm, -27.00 dBm, -46.00 dBm, -13.00 dBm, -13.00 dBm -70.13 dBm, -70.13 dBm, -70.13 dBm, -70.13 dBm, -70.13 dBm, -70.13 dBm</p> <p>LTE, LTETDD: -5.5 dBm, -12.5 dBm, -15.0 dBm, -15.0 dBm, -15.0 dBm, -15.0 dBm -13.5 dBm, -8.5 dBm, -11.5 dBm, -23.5 dBm, -23.5 dBm, -23.5 dBm</p> <p>-----</p> <p>WLAN:</p> <p style="padding-left: 40px;">if Radio Std is 802.11a/g(OFDM/DSSS-OFDM): 16.00 dBm, -4.00 dBm, -12.00 dBm, -24.00 dBm, -24.00 dBm, -24.00 dBm, -24.00 dBm, -24.00 dBm, -24.00 dBm, -24.00 dBm</p> <p style="padding-left: 40px;">if Radio Std is 802.11b/g(DSSS/CCK/PBCC): -10 dBm, -30 dBm, -30 dBm, -30 dBm, -30 dBm, -30 dBm, -30 dBm, -30 dBm, -30 dBm, -30 dBm</p> <p style="padding-left: 40px;">if Radio Std is 802.11n(20MHz) or 802.11ac(20MHz): 16.00 dBm, -4.00 dBm, -12.00 dBm, -63.00 dBm, -63.00 dBm, -63.00 dBm, -63.00 dBm, -63.00 dBm, -63.00 dBm, -63.00 dBm</p> <p style="padding-left: 40px;">if Radio Std is 802.11n(40MHz) or 802.11ac(40MHz): 16.00 dBm, -4.00 dBm, -12.00 dBm, -66.00 dBm, -66.00 dBm, -66.00 dBm, -66.00 dBm, -66.00 dBm, -66.00 dBm, -66.00 dBm</p> <p style="padding-left: 40px;">if Radio Std is 802.11ac(80MHz/160MHz): 16.00 dBm, -4.00 dBm, -12.00 dBm, -69.00 dBm, -69.00 dBm, -69.00 dBm, -69.00 dBm, -69.00 dBm, -69.00 dBm, -69.00 dBm</p> <p style="padding-left: 40px;">if Radio Std is 802.11ac (80 MHz + 80 MHz): -69.00 dBm, -69.00 dBm, -69.00 dBm, -69.00 dBm, -69.00 dBm, -69.00 dBm, -69.00 dBm, -69.00 dBm, -69.00 dBm, -69.00 dBm</p>
State Saved:	Saved in instrument state.
Min:	-200 dBm
Max:	50 dBm
Initial S/W Revision:	Prior to A.02.00

Spectrum Emission Mask Measurement
Meas Setup

Modified at S/W Revision:	A.02.00, A.03.00, A.10.00, A.11.00
Help Map ID:	9029

Abs Stop

Sets the absolute power level limit at the stop frequency for the selected offset. The absolute power level limit ranges from -200 to +50 dBm. You can also toggle this function between couple and manual. If set to Couple, the **Abs Stop** power level limit is coupled to **Abs Start** to result in a flat limit line. If set to Man, Abs Start and Abs Stop take different values to result in a sloped limit line.

The SCPI query returns the five (5) sets of real values currently set to the offset stop absolute power limits.

Key Path:	Meas Setup, Offset/Limits, Limits
Mode:	WCDMA, C2K, WIMAX OFDMA, TD-SCDMA, 1xEVDO, LTE, LTETDD, WLAN
Remote Command:	[:SENSe]:SEMAsk:OFFSet [1] 2:LIST:STOP:ABSolute <real>, ... [:SENSe]:SEMAsk:OFFSet [1] 2:LIST:STOP:ABSolute? [:SENSe]:SEMAsk:OFFSet [1] 2:LIST:STOP:ABSolute:COUPle ON OFF 1 0, ... [:SENSe]:SEMAsk:OFFSet [1] 2:LIST:STOP:ABSolute:COUPle?
Example:	SEM:OFFS:LIST:STOP:ABS -12.50 dBm, -24.50 dBm, -24.50 dBm, -11.50 dBm, -11.50 dBm SEM:OFFS1:LIST:STOP:ABS? SEM:OFFS:LIST:STOP:ABS:COUP ON, OFF, ON, ON, ON, ON SEM:OFFS:LIST:STOP:ABS:COUP?
Notes:	Comma separated list of values. OFFSet1 is for BTS, 2 for MS. Default is BTS. You must be in the mode that includes SEM measurement to use this command. Use :INSTrument:SELEct to set the mode.
Couplings:	Coupled to Abs Start if "Auto" is selected, that is, the Stop value is equal to the Start value.

Preset:	<p>For modes (except WLAN), the preset value is as follows.</p> <p>WIMAX OFDMA: -14.00 dBm, -26.00 dBm, -26.00 dBm, -13.00 dBm, -13.00 dBm, -13.00 dBm</p> <p>WCDMA: -12.50 dBm, -24.50 dBm, -24.50 dBm, -11.50 dBm, -11.50 dBm, -11.50 dBm -69.6 dBm, -54.3 dBm, -54.3 dBm, -54.3 dBm, -54.3 dBm, -54.3 dBm</p> <p>C2K: -27.00 dBm, -27.00 dBm, -27.00 dBm, -46.00 dBm, -13.00 dBm, -13.00 dBm -70.13 dBm, -70.13 dBm, -35.00 dBm, -13.00 dBm, -13.00 dBm, -13.00 dBm</p> <p>TD-SCDMA: -28 dBm, -36 dBm, -36 dBm, -21 dBm, -21 dBm, -21 dBm -71.3 dBm, -71.3 dBm, -56.07 dBm, -56.07 dBm, -56.07 dBm, -56.07 dBm</p> <p>1xEVDO: -27dBm, -27.00 dBm, -27.00 dBm, -46.00 dBm, -13.00 dBm, -13.00 dBm -70.13 dBm, -70.13 dBm, -70.13 dBm, -70.13 dBm, -70.13 dBm, -70.13 dBm</p> <p>LTE, LTETDD:-12.5 dBm, -12.5 dBm, -15.0 dBm, -15.0 dBm, -15.0 dBm, -15.0 dBm -13.5 dBm, -8.5 dBm, -11.5 dBm, -23.5 dBm, -23.5 dBm, -23.5 dBm</p> <p>-----</p> <p>WLAN:</p> <p>if Radio Std is 802.11a/g(OFDM/DSSS-OFDM): -4.00 dBm, -12.00 dBm, -24.00 dBm, -24.00 dBm, -24.00 dBm, -24.00 dBm, -24.00 dBm, -24.00 dBm, -24.00 dBm, -24.00 dBm</p> <p>if Radio Std is 802.11b/g(DSSS/CCK/PBCC): -10 dBm, -30 dBm, -30 dBm, -30 dBm, -30 dBm, -30 dBm, -30 dBm, -30 dBm, -30 dBm, -30 dBm</p> <p>if Radio Std is 802.11n(20MHz) or 802.11ac(20MHz): -4.00 dBm, -12.00 dBm, -24.00 dBm, -63.00 dBm, -63.00 dBm, -63.00 dBm, -63.00 dBm, -63.00 dBm, -63.00 dBm, -63.00 dBm</p> <p>if Radio Std is 802.11n(40MHz) or 802.11ac(40MHz): -4.00 dBm, -12.00 dBm, -24.00 dBm, -66.00 dBm, -66.00 dBm, -66.00 dBm, -66.00 dBm, -66.00 dBm, -66.00 dBm, -66.00 dBm</p> <p>if Radio Std is 802.11ac(80MHz/160MHz): -4.00 dBm, -12.00 dBm, -24.00 dBm, -69.00 dBm, -69.00 dBm, -69.00 dBm, -69.00 dBm, -69.00 dBm, -69.00 dBm, -69.00 dBm</p> <p>if Radio Std is 802.11ac (80 + 80 MHz): -69.00 dBm, -69.00 dBm, -69.00 dBm, -69.00 dBm, -69.00 dBm, -69.00 dBm, -69.00 dBm, -69.00 dBm, -69.00 dBm, -69.00 dBm</p>
---------	---

Spectrum Emission Mask Measurement
Meas Setup

Preset: (Cont)	For modes (except WLAN), the preset value is as follows. WIMAX OFDMA: ON, OFF, ON, ON, ON, ON WCDMA: ON, OFF, ON, ON, ON, ON ON, ON, ON, ON, ON, ON C2K: ON, ON, ON, ON, ON, OFF ON, ON, ON, ON, ON, OFF TD-SCDMA: ON, OFF, ON, ON, ON, ON ON, ON, ON, ON, ON, ON 1xEVDO: ON, ON, ON, ON, ON, OFF ON, ON, ON, ON, ON, OFF LTE, LTETDD: OFF, ON, ON, ON, ON, ON ON, ON, ON, ON, ON, ON ----- WLAN: if Radio Std is 802.11a/g(OFDM/DSSS-OFDM)/802.11n(20MHz/40MHz)/802.11 ac(20MHz/40MHz/80MHz/160MHz): OFF, OFF, OFF, ON, ON, ON, ON, ON, ON, ON, ON, ON if Radio Std is 802.11 ac(80+80 MHz): ON, ON, ON, ON, ON, ON, ON, ON, ON, ON, ON, ON if Radio Std is 802.11b/g(DSSS/CCK/PBCC): ON, ON, ON, ON, ON, ON, ON, ON, ON, ON, ON, ON
State Saved:	Saved in instrument state.
Min:	-200 dBm
Max:	50 dBm
Initial S/W Revision:	Prior to A.02.00
Modified at S/W Revision:	A.02.00, A.03.00, A.10.00, A.11.00
Help Map ID:	9030

Rel Start

Sets a relative power level limit at the start frequency for the selected offset. The relative power level limit ranges from -200 to +50 dBc.

The fail condition is set remotely by [:SENSE]:SEMask:OFFSet[n]:LIST:TEST for each offset channel test.

You can turn off (not use) specific offset channels remotely with [:SENSE]:SEMask:OFFSet[n]:LIST:STATE.

The SCPI query returns the five (5) sets of real values currently set to the relative power test limits.

Key Path:	Meas Setup, Offset/Limits, Limits
Mode:	WCDMA, C2K, WIMAX OFDMA, TD-SCDMA, 1xEVDO, LTE, LTETDD, WLAN

Remote Command:	<pre>[:SENSE] :SEMAsk:OFFSet [1] 2 :LIST:STARt:RCARrier <rel_ampl>, ... [:SENSE] :SEMAsk:OFFSet [1] 2 :LIST:STARt:RCARrier?</pre>
Example:	<pre>SEM:OFFS:LIST:STAR:RCAR -30, -30, -30, -30, -30, -30 SEM:OFFS:LIST:STAR:RCAR?</pre>
Notes:	<p>Comma separated list of values.</p> <p>OFFSet1 is for BTS, 2 for MS. Default is BTS.</p> <p>You must be in the mode that includes SEM measurement to use this command. Use :INSTrument:SELEct to set the mode.</p>
Couplings:	<p>Coupled to Rel Stop is coupling set to “Couple”, that is, Start is made the same as Stop.</p>
Preset:	<p>For modes (except WLAN), the preset value is as follows.</p> <p>WCDMA: -30.00 dB, -30.00 dB, -30.00 dB, -30.00 dB, -30.00 dB, -30.00 dB -33.73 dB, -34.00 dB, -37.50 dB, -47.50 dB, -47.50 dB, -47.50 dB</p> <p>C2K: -45.00 dB, -45.00 dB, -55.00 dB, -55.00 dB, -55.00 dB, -55.00 dB -42.00 dB, -54.00 dB, -54.00 dB, -54.00 dB, -54.00 dB, -54.00 dB</p> <p>WIMAX OFDMA: 0 dB, -25 dB, -32 dB, -50 dB, -50 dB, -50 dB</p> <p>TD-SCDMA: -54.00 dB, -54.00 dB, -62.00 dB, -47.00 dB, -47.00 dB, -47.00 dB -35.21 dB, -49.00 dB, -44.00 dB, -44.00 dB, -44.00 dB, -44.00 dB</p> <p>1xEVDO: -45dBc, -45.00 dB, -55.00 dB, -55.00 dB, -55.00 dB, -55.00 dB -42dBc, -54.00 dB, -54.00 dB, -54.00 dB, -54.00 dB, -54.00 dB</p> <p>LTE, LTETDD: 0 dB, 0 dB, 0 dB, 0 dB, 0 dB, 0 dB 0 dB, 0 dB, 0 dB, 0 dB, 0 dB, 0 dB</p> <p>-----</p> <p>WLAN:</p> <p>if Radio Std is 802.11a/g(OFDm/DSSS-OFDM): 0 dB, -20.00 dB, -28.00 dB, -40.00 dB, -40.00 dB, -47.00 dB, -47.00 dB, -47.00 dB, -47.00 dB, -47.00 dB, -47.00 dB</p> <p>if Radio Std is 802.11b/g(DSSS/CCK/PBCC): -30 dB, -50 dB, -50 dB, -50 dB, -50 dB, -50 dB, -50 dB, -50 dB, -50 dB, -50 dB</p> <p>if Radio Std is 802.11n(20MHz/40MHz): 0 dB, -20.00 dB, -28.00 dB, -45.00 dB, -45.00 dB, -45.00 dB, -45.00 dB, -45.00 dB, -45.00 dB, -45.00 dB</p> <p>if Radio Std is 802.11ac (20 MHz/ 40 MHz/ 80 MHz/ 160 MHz): 0 dB, -20.00 dB, -28.00 dB, -40.00 dB, -40.00 dB, -40.00 dB, -40.00 dB, -40.00 dB, -40.00 dB, -40.00 dB</p> <p>if Radio Std is 802.11ac(80 MHz + 80MHz): -40.00 dB, -28.00 dB, -20 dB, 0 dB, -20 dB, -28 dB, -40 dB, -40 dB, -40.00 dB, -40.00 dB, -40.00 dB, -40.00 dB</p>

Spectrum Emission Mask Measurement
Meas Setup

State Saved:	Saved in instrument state.
Min:	-200 dB
Max:	50 dB
Initial S/W Revision:	Prior to A.02.00
Modified at S/W Revision:	A.02.00, A.03.00, A.10.00, A.11.00
Help Map ID:	9031

Rel Stop

Sets a relative power level limit at the stop frequency for the selected offset. The relative power level limit ranges from -200 to +50 dBc.

The fail condition is set remotely by [:SENSE]:SEMAsk:OFFSet[n]:LIST:TEST for each offset channel.

You can turn off (not use) specific offset channels remotely with [:SENSe]:SEMAsk:OFFSet[n]:LIST:STATe.

The SCPI query returns the five (5) sets of real values currently set to the offset stop relative power limits.

Key Path:	Meas Setup, Offset/Limits, Limits
Mode:	WCDMA, C2K, WIMAX OFDMA, TD-SCDMA, 1xEVDO, LTE, LTETDD, WLAN
Remote Command:	[:SENSe]:SEMAsk:OFFSet [1] 2:LIST:STOP:RCARrier <rel_ampl>, ... [:SENSe]:SEMAsk:OFFSet [1] 2:LIST:STOP:RCARrier? [:SENSe]:SEMAsk:OFFSet [1] 2:LIST:STOP:RCARrier:COUPle ON OFF 1 0, ... [:SENSe]:SEMAsk:OFFSet [1] 2:LIST:STOP:RCARrier:COUPle?
Example:	SEM:OFFS:LIST:STOP:RCAR -30, -30, -30, -30, -30, -30 SEM:OFFS:LIST:STOP:RCAR? SEM:OFFS:LIST:STOP:RCAR:COUP ON, ON, ON, ON, ON, ON SEM:OFFS:LIST:STOP:RCAR:COUP?
Notes:	Comma separated list of values. OFFSet1 is for BTS, 2 for MS. Default is BTS. You must be in the mode that includes SEM measurement to use this command. Use :INSTrument:SELEct to set the mode.
Couplings:	Coupled to Abs Start if "Auto" is selected, that is, the Stop value is equal to the Start value.

Preset:	<p>For modes (except WLAN), the preset value is as follows.</p> <p>WCDMA: -30.00 dB, -30.00 dB, -30.00 dB, -30.00 dB, -30.00 dB, -30.00 dB -48.28 dB, -37.50 dB, -47.50 dB, -47.50 dB, -47.50 dB, -47.50 dB</p> <p>C2K: -45.00 dB, -45.00 dB, -55.00 dB, -55.00 dB, -55.00 dB, -55.00 dB -42.00 dB, -54.00 dB, -54.00 dB, -54.00 dB, -54.00 dB, -54.00 dB</p> <p>WIMAX OFDMA: -25 dB, -32 dB, -50 dB, -50 dB, -50 dB, -50 dB</p> <p>TD-SCDMA: -54.00 dB, -62.00 dB, -62.00 dB, -47.00 dB, -47.00 dB, -47.00 dB -49.00 dB, -58.945 dB, -44.00 dB, -44.00 dB, -44.00 dB, -44.00 dB</p> <p>1xEVDO: -45dB, -45.00 dB, -55.00 dB, -55.00 dB, -55.00 dB, -55.00 dB -42dB, -54.00 dB, -54.00 dB, -54.00 dB, -54.00 dB, -54.00 dB</p> <p>LTE, LTETDD: 0 dB, 0 dB, 0 dB, 0 dB, 0 dB, 0 dB</p> <p>-----</p> <p>WLAN:</p> <p>if Radio Std is 802.11a/g(OFDM/DSSS-OFDM): -20.00 dB, -28.00 dB, -40.00 dB, -40.00 dB, -47.00 dB, -47.00 dB, -47.00 dB, -47.00 dB, -47.00 dB, -47.00 dB</p> <p>if Radio Std is 802.11b/g(DSSS/CCK/PBCC): -30 dB, -50 dB, -50 dB, -50 dB, -50 dB, -50 dB, -50 dB, -50 dB, -50 dB, -50 dB</p> <p>if Radio Std is 802.11n(20MHz/40MHz): -20.00 dB, -28.00 dB, -45.00 dB, -45.00 dB, -45.00 dB, -45.00 dB, -45.00 dB, -45.00 dB, -45.00 dB, -45.00 dB</p> <p>if Radio Std is 802.11ac (20 MHz/ 40 MHz/ 80 MHz/ 160 MHz): -20.00 dB, -28.00 dB, -40.00 dB, -40.00 dB, -40.00 dB, -40.00 dB, -40.00 dB, -40.00 dB, -40.00 dB, -40.00 dB</p> <p>if Radio Std is 802.11ac(80 MHz + 80MHz): -28.00 dB, -20.00 dB, 0 dB, -20.00 dB, -28.00 dB, -40.00 dB, -40.00 dB, -40.00 dB, -40.00 dB, -40.00 dB</p>
---------	--

Spectrum Emission Mask Measurement
Meas Setup

Preset: (Cont)	For modes (except WLAN), the preset value is as follows. WCDMA: ON, ON, ON, ON, ON, ON OFF, OFF, OFF, ON, ON, ON C2K: ON, ON, ON, ON, ON, OFF ON, ON, ON, ON, ON, OFF WIMAX OFDMA: OFF, OFF, OFF, ON, ON, ON OFF, OFF, OFF, ON, ON, ON TD-SCDMA: ON, OFF, ON, ON, ON, ON OFF,OFF,ON,ON,ON,ON 1xEVDO: ON, ON, ON, ON, ON, OFF ON, ON, ON, ON, ON, OFF LTE, LTETDD: ON, ON, ON, ON, ON, ON ----- WLAN: if Radio Std is 802.11a/g(OFDM/DSSS-OFDM)/802.11n(20MHz/40MHz): OFF, OFF, OFF, ON, ON, ON, ON, ON, ON, ON, ON, ON if Radio Std is 802.11b/g(DSSS/CCK/PBCC): ON, ON, ON, ON, ON, ON, ON, ON, ON, ON, ON, ON if Radio Std is 802.11ac (20 MHz/ 40 MHz/ 80 MHz/ 160 MHz): OFF, OFF, OFF, ON, ON, ON, ON, ON, ON, ON, ON, ON if Radio Std is 802.11ac(80 MHz + 80MHz): OFF, OFF, OFF, OFF, OFF, OFF, OFF, OFF, OFF, OFF, OFF, OFF
State Saved:	Saved in instrument state.
Min:	-200 dB
Max:	50 dB
Initial S/W Revision:	Prior to A.02.00
Modified at S/W Revision:	A.02.00, A.03.00, A.10.00, A.11.00
Help Map ID:	9032

Fail Mask

Selects one of the logic keys for fail conditions between the measurement results and the test limits:

- **Absolute** and **Relative** both check the results against the respective limit.
- **OR** checks against both limits, failing if either of the limits is broken.
- **AND** will only display a fail if both of the limits are broken.

The absolute or relative power limit value for each offset channel can be set remotely with
[:SENSe]:SEMAsk:OFFSet[n]:LIST:ABSolute or [:SENSe]:SEMAsk:OFFSet[n]:LIST:RCARrier.

You can turn off (not use) specific offset channels remotely with
[:SENSe]:SEMAsk:OFFSet[n]:LIST:STATe.

Key Path:	Meas Setup, Offset/Limits, Limits
-----------	--

Mode:	WCDMA, C2K, WIMAX OFDMA, TD-SCDMA, 1xEVDO, LTE, LTETDD, WLAN
Remote Command:	[:SENSe] :SEMAsk:OFFSet [1] 2 :LIST:TEST ABSolute AND OR RELative, ... [:SENSe] :SEMAsk:OFFSet [1] 2 :LIST:TEST?
Example:	SEM:OFFS:LIST:TEST ABS, ABS, ABS, ABS, ABS, ABS SEM:OFFS:LIST:TEST?
Notes:	Comma separated list of values. You must be in the mode that includes SEM measurement to use this command. Use :INSTrument:SElect to set the mode.
Preset:	For modes (except WLAN), the preset value is as follows. WCDMA: ABS, ABS, ABS, ABS, ABS, ABS AND, AND, AND, AND, AND, AND C2K: REL, REL, REL, ABS, REL, REL AND, AND, ABS, REL, REL, REL WIMAX OFDMA: REL, REL, REL, REL, REL, REL REL, REL, REL, REL, REL, REL TD-SCDMA: ABS, ABS, ABS, ABS, ABS, ABS AND, AND, AND, AND, AND, AND 1xEVDO: REL, REL, REL, ABS, REL, REL AND, AND, AND, OR, AND, AND LTE, LTDTDD: ABS, ABS, ABS, ABS, ABS, ABS ----- WLAN: if Radio Std is 802.11a/g(OFDM/DSSS-OFDM) or 802.11b/g(DSSS/CCK/PBCC): REL, REL, REL, REL, REL, REL, REL, REL, REL, REL, REL, REL if Radio Std is 802.11n(20MHz/40MHz): REL, REL, REL, AND, AND, AND, AND, AND, AND, AND, AND, AND if Radio Std is 802.11ac (20 MHz/ 40 MHz/ 80 MHz/ 160 MHz): REL, REL, REL, AND, AND, AND, AND, AND, AND, AND, AND, AND if Radio Std is 802.11ac (80 MHz + 80MHz): REL, REL, REL, REL, REL, REL, REL, AND, AND, AND, AND, AND, AND, AND
State Saved:	Saved in instrument state.
Range:	Absolute Relative Abs AND Rel Abs OR Rel
Initial S/W Revision:	Prior to A.02.00
Modified at S/W Revision:	A.02.00, A.03.00, A.10.00, A.11.00
Help Map ID:	9033

Offset Freq Define

This key enables you to select “Offset” definition. Each standard defines each “Offset” from Carrier.

Meas BW Edge means the edge of resolution band width that is represented by Meas BW and Res BW settings. Actual center frequency of Meas BW and the limit line have $\frac{1}{2}$ Meas BW offset when the Meas BW Edge is selected.

3GPP2 requires the “Carrier Center to Meas BW Edge” definition. LTE conformance test requires “Carrier Edge to Meas BW Center” and/or “Carrier Edge to Meas BW Edge” definition

- **CTOCenter** – From carrier center to the center of offset measuring filter*
- **CTOEdge** - From carrier center to the nominal -3 dB point of the offset measuring filter* closer to the carrier
- **ETOCenter** – From Center Frequency - Span of Ref Channel / 2 (for lower offset), Center Frequency + Span of Ref Channel / 2 (for upper offset) of the carrier closest to each offset to the center of offset measuring filter*
- **ETOEdge** - From Center Frequency - Span of Ref Channel / 2 (for lower offset), Center Frequency + Span of Ref Channel / 2 (for upper offset) of the carrier closest to each offset to the nominal -3 dB point of the offset measuring filter* closer to the carrier
- *Measuring filter = Meas BW (N x Res BW)

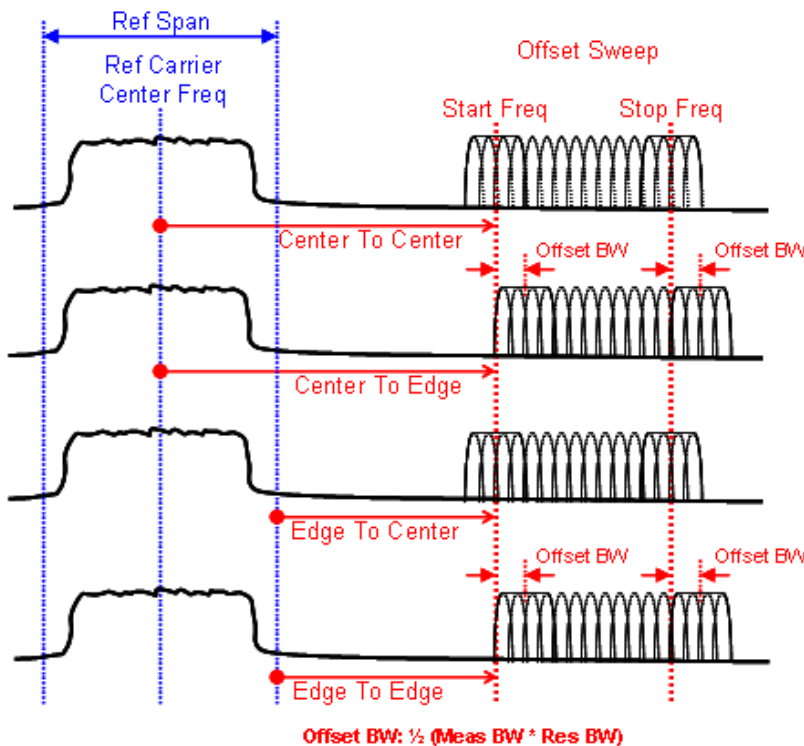

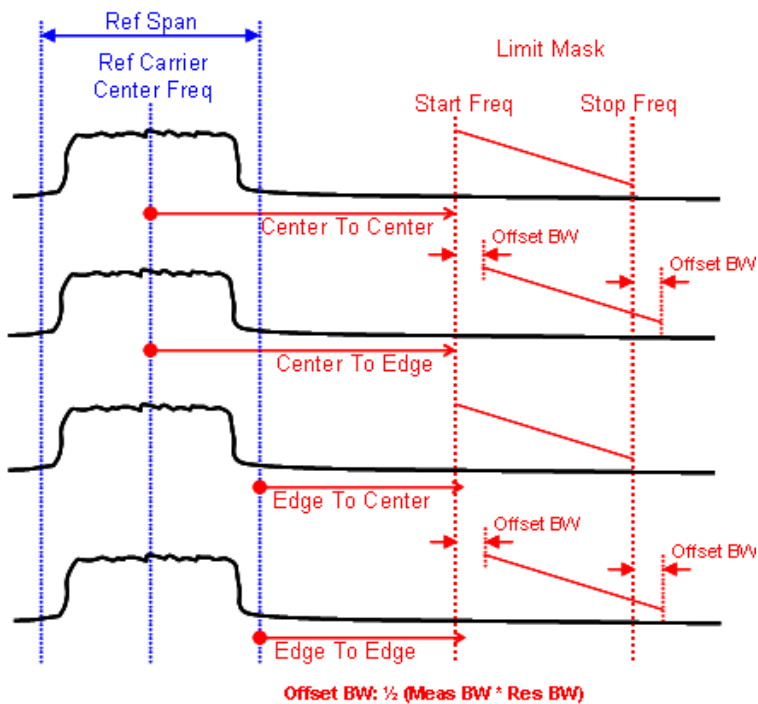

Key Path:	Meas Setup, Offset/Limits
Mode:	WCDMA, C2K, WIMAX OFDMA, TD-SCDMA, 1xEVDO, LTE, LTETDD, WLAN
Remote Command:	[:SENSe] :SEMAsk:OFFSet [1] 2 :TYPE CTOCenter CTOEdge ETOCenter ETOEdge [:SENSe] :SEMAsk:OFFSet [1] 2 :TYPE?
Example:	SEM:OFFS:TYPE ETOC SEM:OFFS:TYPE?
Notes:	You must be in the mode that includes SEM measurements to use this command. Use :INSTrument:SElect to set the mode.
Preset:	WCDMA, WIMAX OFDMA, TD-SCDMA: CTOC C2K: CTOE 1xEVDO: CTOE LTE: ETOC LTETDD: ETOC
State Saved:	Saved in instrument state.
Range:	Carrier Center To Meas BW Center Carrier Center To Meas BW Edge Carrier Edge To Meas BW Center Carrier Edge To Meas BW Edge

Spectrum Emission Mask Measurement
Meas Setup

Initial S/W Revision:	A.03.00
Help Map ID:	9080

Method

Sets the measurement method:

- **Integ BW**-enables you to set the channel integration bandwidth.
- **RRC Weight**-selects Root Raised Cosine (RRC) filtering of the carriers. The α value (rolloff) for the filter is set to the value of the Filter Alpha parameter.

Key Path:	Meas Setup
Mode:	WCDMA, WIMAX OFDMA, TD-SCDMA, LTE, LTETDD, WLAN
Remote Command:	[:SENSE] :SEMAsk :FILTEr [:RRC] [:STATE] OFF ON 0 1 [:SENSE] :SEMAsk :FILTEr [:RRC] [:STATE] ?
Example:	SEM:FILT ON SEM:FILT?
Notes:	For the CDMA2K and CDMA1xEVDO mode, this key is not available. 1 ON = RRC Weight, 0 OFF = IntegBW You must be in the mode that includes SEM measurement to use this command. Use :INSTrument:SELEct to set the mode.
Dependencies:	WLAN: RRC Weight is not supported when the radio standard is WLAN 802.11ac (80+80MHz).
Preset:	WIMAX OFDMA, LTE, LTETDD, WLAN: OFF WCDMA, TD-SCDMA: ON
State Saved:	Saved in instrument state.
Range:	RRCWeight IntegBW
Initial S/W Revision:	Prior to A.02.00
Modified at S/W Revision:	A.02.00, A.03.00
Help Map ID:	9034

Filter Alpha

Sets the alpha value for the RRC Filter.

Key Path:	Meas Setup
Mode:	WCDMA, WIMAX OFDMA, TD-SCDMA, LTE, LTETDD,

Remote Command:	[:SENSe] :SEMAsk:FILTer[:RRC]:ALPHa <real> [:SENSe] :SEMAsk:FILTer[:RRC]:ALPHa?
Example:	SEM:FILT:ALPH 0.3 SEM:FILT:ALPH?
Notes:	For the CDMA2K and CDMA1xEVDO mode, this key is not available. You must be in the mode that includes SEM measurement to use this command. Use :INSTrument:SElect to set the mode.
Preset:	0.22
State Saved:	Saved in instrument state.
Min:	0.01
Max:	1.0
Initial S/W Revision:	Prior to A.02.00
Modified at S/W Revision:	A.02.00, A.03.00
Help Map ID:	9035

Meas Preset

Restores all the measurement parameters to their default values.

Key Path:	Meas Setup
Mode:	WCDMA, C2K, WIMAX OFDMA, TD-SCDMA, 1xEVDO, LTE, LTETDD, WLAN
Remote Command:	:CONFigure:SEMAsk
Example:	CONF:SEM
Notes:	You must be in the mode that includes SEM measurement to use this command. Use :INSTrument:SElect to set the mode.
Couplings:	Selecting Meas Preset will restore all measurement parameters to their default values.
Initial S/W Revision:	Prior to A.02.00
Modified at S/W Revision:	A.02.00, A.03.00
Help Map ID:	9036

Limit State(Only for TD-SCDMA)

The key “Limits State” is only displayed in the TD-SCDMA mode. The mask lines could be drawn in two different ways, according to the 3GPP standard for the base station when the key’s value is “Std”; or

Spectrum Emission Mask Measurement
Meas Setup

by the user-defined specifications listed in the Offset/Limits menu.

Key Path:	Meas Setup
Mode:	TD-SCDMA
Remote Command:	[:SENSE] :SEMAsk:LIMits STD MAN [:SENSE] :SEMAsk:LIMits?
Example:	SEM:LIM STD SEM:LIM?
Notes:	You must be in the TD-SCDMA mode to use this command. Use :INSTrument:SElect to set the mode.
Dependencies:	See Couplings
Couplings:	When the value of the “Limits” key is Std, the parameters displayed on the Offset/Limits panel will be modified depending on the carrier power, which corresponds to the measurement standard of the base station. All the keys except “Offset”, “Relative Atten”, “Offset Side” and “Limits” displayed on the “Offset/Limits” panel will be grayed out. All the keys displayed on the “Limits” panel will be grayed out as well. When the value of the “Limits” key is Man, all of the previous manual specifications will be restored, and the keys that were previously grayed out will be enabled again.
Preset:	MAN
State Saved:	Saved in instrument state.
Range:	STD MAN
Initial S/W Revision:	Prior to A.02.00
Help Map ID:	9011

80+80 MHz Mask (Only for WLAN)

The key “80+80 MHz Mask” is visible only when the license for 802.11 ac format is available, and is only enabled when the radio standard is 802.11ac (80 MHz + 80 MHz). The mask lines could be drawn in two different ways, according to the IEEE 802.11ac standard (entry 22.3.18.1) when the key’s value is “Auto”; or by the user-defined specifications listed in the Offset/Limits menu.

Key Path:	Meas Setup
Mode:	WLAN
Remote Command:	[:SENSE] :SEMAsk:T80Mask:AUTO ON OFF 1 0 [:SENSE] :SEMAsk:T80Mask:AUTO?
Example:	SEM:T80M:AUTO 1 SEM:T80M:AUTO?

Notes:	You must be in the WLAN mode to use this command. Use :INSTrument:SElect to set the mode.
Dependencies:	See Couplings
Couplings:	<p>When the value of the “80+80 MHz Mask” key is Auto, the offset frequencies and the offset relative limits are calculated based on the spacing between the center frequencies of the two carriers according to the IEEE 802.11ac standard. All the keys except “Offset”, “Relative Atten”, “Offset Side” and “Limits” displayed on the “Offset/Limits” panel gray out. All the keys displayed on the “Limits” panel gray out as well. On top of that, the displayed values of the keys on the “Offset/Limits” panel are not used in the measurement! On top of that, the channel span will be set to the value satisfying the equations below if its previous value is less than the value calculated through the equations.</p> <p>Chan Span = spacing between the two carriers + Chan IntegBW;</p> <p>When the value of the 80+80 MHz Mask key is Man, the keys that were previously grayed out will be enabled again.</p>
State Saved:	Saved in instrument state.
Range:	Auto Man
Help Map ID:	9089

Mode

See [Mode@2670@i](#) for more information.

Key Path:	Front-panel key
Initial S/W Revision:	Prior to A.02.00
Help Map ID:	0

Mode Setup

See [Mode Setup@\(SA\)4001, \(WCDMA\)4536, \(OFDMA\)20022, \(cdma2000\)26100, \(1xEVDO\)28100, \(TD-SCDMA\)4001, \(DVB-T/H\)31051, \(DTMB\)30851, \(CMMB\)40051, \(ISDB-T\)40250, \(Digital Cable TV\)41901, \(LTE\)28881, \(LTE TDD\)40450, \(WLAN\)45501, \(MSR\)45042](#) for more information.

Key Path:	Front-panel key
Initial S/W Revision:	Prior to A.02.00
Help Map ID:	0

Peak Search

There is no ‘Peak Search’ supported in Spectrum Emission Mask so this front-panel key displays a blank

Spectrum Emission Mask Measurement Meas Setup

menu when pressed.

Key Path:	Front-panel key
Initial S/W Revision:	Prior to A.02.00
Help Map ID:	9072

Recall

See [Recall@2637, \(LTE\)28892, \(LTETDD\)40472, \(MSR\)45000](#) for more information.

Key Path:	Front-panel key
Initial S/W Revision:	Prior to A.02.00
Help Map ID:	0

Restart

See [Restart@3307@i](#) for more information.

Key Path:	Front-panel key
Initial S/W Revision:	Prior to A.02.00
Help Map ID:	0

Save

See [Save@2600, \(MSR\)45003@i](#) for more information.

Key Path:	Front-panel key
Initial S/W Revision:	Prior to A.02.00
Help Map ID:	0

Data

See [Data@2611@i](#) for more information.

Key Path:	Front-panel key
Help Map ID:	0

Measurement Results

Pressing this key selects Meas Results as the data type to be exported.

The Meas Results file contains information that describes the current state of the analyzer. It is detailed

in “Meas Results File Contents” on page 629 below.

Key Path:	Save, Data
Remote Command:	:MMEMory:STORe:RESults <string>
Example:	:MMEM:STOR:RES “MeasR_0000.csv”
Notes:	<p>If the save is initiated via SCPI and the file already exists, the file will be overwritten.</p> <p>The SCPI command exports Spectrum Emission Mask measurement results to the file specified as the parameter in the current path. The default path is My Documents\<current mode>\data\SEM\results.</p> <p>Using the C: drive is strongly discouraged, since it runs the risk of being overwritten during an instrument software upgrade.</p> <p>The SCPI parameter is a quoted string that specifies the filename. Both single and double quotes are supported for any filename parameter over SCPI.</p>
Dependencies:	The current active measurement must be the Spectrum Emission Mask measurement to use this command.
Status Bits/OPC dependencies:	Sequential – waits for the previous measurement to complete
Initial S/W Revision:	Prior to A.02.00
Help Map ID:	9090

Meas Results File Contents

A Meas Results File contains measurement results with the following information.

- File ID string, which is “MeasResult”
- Measurement ID following Mode ID, which is “SA:SEM” for example.
- Firmware rev and model number
- Option string
- Automatic Trigger Time
- Automatic Trigger Time State
- Center Frequency
- ChanIntegBW
- ChannelDetector
- ChannelDetectorState
- ChanPwrRefAuto
- ChanResBW
- ChanResBWAuto
- ChanSpan

Spectrum Emission Mask Measurement Meas Setup

- ChanSweepTime
- ChanSweepTimeAuto
- ChanVbwRbwRatio
- ChanVbwRbwRatioAuto
- ChanVideoBW
- ChanVideoBWAuto
- Electrical Atten
- Electrical Atten Bypass
- Electrical Atten State
- External1 Trigger Delay
- External1 Trigger Delay State
- External1 Trigger Level
- External1 Trigger Slope
- External2 Trigger Delay
- External2 Trigger Delay State
- External2 Trigger Level
- External2 Trigger Slope
- FilterAlpha
- Internal Preamp
- Internal Preamp Band
- Line Trigger Delay
- Line Trigger Delay State
- Line Trigger Slope
- Mechanical Atten
- Mechanical Atten Auto
- OffsetDetector
- OffsetDetectorState
- OffsetLimitAbsStartBTS
- OffsetLimitAbsStartMS
- OffsetLimitAbsStopBTS
- OffsetLimitAbsStopMS
- OffsetLimitFailMaskBTS

- OffsetLimitFailMaskMS
- OffsetLimitRelStartBTS
- OffsetLimitRelStartMS
- OffsetLimitRelStopBTS
- OffsetLimitRelStopMS
- OffsetMeasBWbts
- OffsetMeasBWMS
- OffsetResolutionBWAutoBTS
- OffsetResolutionBWAutoMS
- OffsetResolutionBWbts
- OffsetResolutionBWMS
- OffsetSideBTS
- OffsetSideMS
- OffsetStartFrequencyBTS
- OffsetStartFrequencyMS
- OffsetStateBTS
- OffsetStateMS
- OffsetStopFrequencyBTS
- OffsetStopFrequencyMS
- OffsetSweepTimeAutoBTS
- OffsetSweepTimeAutoMS
- OffsetSweepTimeBTS
- OffsetSweepTimeMS
- OffsetVbwRbwRatioAutoBTS
- OffsetVbwRbwRatioAutoMS
- OffsetVbwRbwRatioBTS
- OffsetVbwRbwRatioMS
- OffsetVideoBWAutoBTS
- OffsetVideoBWAutoMS
- OffsetVideoBWbts
- OffsetVideoBWMS
- PeakReference

Spectrum Emission Mask Measurement Meas Setup

- Periodic Timer Period
- Periodic Timer Sync Source
- Periodic Timer Trigger Delay
- Periodic Timer Trigger Delay State
- PowerReference
- PSDReference
- Radio Device
- RFBurst Trigger Delay
- RFBurst Trigger Delay State
- RFBurst Trigger Level Abs
- RFBurst Trigger Level Rel
- RFBurst Trigger Level Type
- RFBurst Trigger Slope
- RrcFilter
- SemAverageNumber
- SemAverageState
- TotalAtten
- Trigger Holdoff
- Trigger Holdoff State
- TriggerSource
- Video Trigger Delay
- Video Trigger Delay State
- Video Trigger Level
- Video Trigger Slope
- ViewSelection

The file contains these data followed by MeasResult1 to MeasResult12 that flag the start of the measurement results. Each line of Measurement Results consists of twelve comma separated values from MeasResult1 value to MeasResult12 value. MeasResult1 contains the same results as MEAS/READ/FETCH:SEMAsk1; MeasResult2, MEAS/READ/FETCH:SEMAsk2; MeasResult3, MEAS/READ/FETCH:SEMAsk3;... (continues in the same manner)

The exported file is in CSV format, with a.csv extension. The Meas Results file, when imported into Excel, shows the following data:

MeasResult												
------------	--	--	--	--	--	--	--	--	--	--	--	--

SA:SEM											
A.10.53	N9030 A										
B25 B40	1										
Automatic Trigger Time	0.1										
Automatic Trigger Time State	FALS E										
Center Frequency	1.33E +10										
ChanIntegB W	38400 00	38400 00									
ChannelDete ctor	Avera ge										
ChannelDete ctorState	TRUE										
ChanPwrRef Auto	TRUE										
ChanResBW	10000 0	10000 0									
ChanResBW Auto	FALS E	FALS E									
ChanSpan	50000 00	50000 00									
ChanSweep Time	0.0025 07	0.0025 07									
ChanSweep TimeAuto	TRUE	TRUE									
ChanVbwRb wRatio	1	1									
ChanVbwRb wRatioAuto	FALS E	FALS E									
ChanVideoB W	10000 0	10000 0									
ChanVideoB WAuto	TRUE	TRUE									
Electrical Atten	0										

Spectrum Emission Mask Measurement
Meas Setup

Electrical Atten Bypass	TRUE										
Electrical Atten State	FALS E										
External1 Trigger Delay	1.00E -06										
External1 Trigger Delay State	FALS E										
External1 Trigger Level	1.2										
External1 Trigger Slope	Positiv e										
External2 Trigger Delay	1.00E -06										
External2 Trigger Delay State	FALS E										
External2 Trigger Level	1.2										
External2 Trigger Slope	Positiv e										
FilterAlpha	0.22										
Internal Preamp	FALS E										
Internal Preamp Band	Low										
Line Trigger Delay	1.00E -06										
Line Trigger Delay State	FALS E										
Line Trigger Slope	Positiv e										

Mechanical Atten	10										
Mechanical Atten Auto	TRUE										
OffsetDetector	Peak										
OffsetDetectorState	TRUE										
OffsetLimitAbsStartBTS	-14	-14	-26	-13	-13	-13					
OffsetLimitAbsStartMS	-14	-14	-26	-13	-13	-13					
OffsetLimitAbsStopBTS	-14	-26	-26	-13	-13	-13					
OffsetLimitAbsStopMS	-14	-26	-26	-13	-13	-13					
OffsetLimitFailMaskBTS	ABSolute	ABSolute	ABSolute	ABSolute	ABSolute	ABSolute					
OffsetLimitFailMaskMS	ABSolute	ABSolute	ABSolute	ABSolute	ABSolute	ABSolute					
OffsetLimitRelStartBTS	-30	-30	-30	-30	-30	-30					
OffsetLimitRelStartMS	-30	-30	-30	-30	-30	-30					
OffsetLimitRelStopBTS	-30	-30	-30	-30	-30	-30					
OffsetLimitRelStopMS	-30	-30	-30	-30	-30	-30					
OffsetMeasBWBTS	1	1	1	1	1	1					
OffsetMeasBWMMS	1	1	1	1	1	1					
OffsetResolutionBWAutoBTS	FALSE	FALSE	FALSE	FALSE	FALSE	FALSE					
OffsetResolutionBWAutoMS	FALSE	FALSE	FALSE	FALSE	FALSE	FALSE					

Spectrum Emission Mask Measurement
Meas Setup

OffsetResolutionBW BTS	30000	30000	30000	100000	100000	100000					
OffsetResolutionBW MS	30000	30000	30000	100000	100000	100000					
OffsetSideBTS	Both	Both	Both	Both	Both	Both					
OffsetSideMS	Both	Both	Both	Both	Both	Both					
OffsetStartFrequencyBTS	2515000	2715000	3515000	4000000	8000000	12500000					
OffsetStartFrequencyMS	2515000	2715000	3515000	4000000	8000000	12500000					
OffsetStateBTS	TRUE	TRUE	TRUE	TRUE	TRUE	FALSE					
OffsetStateMS	TRUE	TRUE	TRUE	TRUE	TRUE	FALSE					
OffsetStopFrequencyBTS	2715000	3515000	4000000	8000000	12500000	15000000					
OffsetStopFrequencyMS	2715000	3515000	4000000	8000000	12500000	15000000					
OffsetSweepTimeAutoBTS	TRUE	TRUE	TRUE	TRUE	TRUE	TRUE					
OffsetSweepTimeAutoMS	TRUE	TRUE	TRUE	TRUE	TRUE	TRUE					
OffsetSweepTimeBTS	0.017333	0.06932	0.042027	0.002053	0.002253	0.001253					
OffsetSweepTimeMS	0.017333	0.06932	0.042027	0.002053	0.002253	0.001253					
OffsetVbwRbwRatioAutoBTS	FALSE	FALSE	FALSE	FALSE	FALSE	FALSE					
OffsetVbwRbwRatioAutoMS	FALSE	FALSE	FALSE	FALSE	FALSE	FALSE					
OffsetVbwRbwRatioBTS	0.01	0.01	0.01	0.01	0.01	0.01					
OffsetVbwRbwRatioMS	0.01	0.01	0.01	0.01	0.01	0.01					

OffsetVideo BWAutoBTS	TRUE	TRUE	TRUE	TRUE	TRUE	TRUE					
OffsetVideo BWAutoMS	TRUE	TRUE	TRUE	TRUE	TRUE	TRUE					
OffsetVideo BWBTS	300	300	300	10000	10000	10000					
OffsetVideo BWMS	300	300	300	10000	10000	10000					
PeakReference	-82.9957										
Periodic Timer Period	0.02										
Periodic Timer Sync Source	None										
Periodic Timer Trigger Delay	1.00E-06										
Periodic Timer Trigger Delay State	FALSE										
PowerReference	-73.6966										
PSDReference	-139.54										
Radio Device	Bts										
RFBurst Trigger Delay	1.00E-06										
RFBurst Trigger Delay State	FALSE										
RFBurst Trigger Level Abs	-20										
RFBurst Trigger Level Rel	-6										

Spectrum Emission Mask Measurement
Meas Setup

RFBurst Trigger Level Type	Absolute										
RFBurst Trigger Slope	Positive										
RrcFilter	FALSE										
SemAverage Number	10										
SemAverage State	FALSE										
TotalAtten	10										
Trigger Holdoff	0.1										
Trigger Holdoff State	FALSE										
TriggerSource	Free										
Video Trigger Delay	1.00E-06										
Video Trigger Delay State	FALSE										
Video Trigger Level	-25										
Video Trigger Slope	Positive										
Video Selection	AbsPwrFreq										
MeasResult1	MeasResult2	MeasResult3	MeasResult4	MeasResult5	MeasResult6	MeasResult7	MeasResult8	MeasResult9	MeasResult10	MeasResult11	MeasResult12
-999	-78.89359	-13	999	-73.6966334099879	-999	-999	-999	-999	-999	-999	-999

Spectrum Emission Mask Measurement
Meas Setup

-73.6966334 099879	-78.95 235	-13	999	-999	-999	-999	-999	-999	-999	-999	
-----------------------	---------------	-----	-----	------	------	------	------	------	------	------	--

Single

See [Single \(Single Measurement/Sweep\)@3515@i](#) for more information.

Key Path:	Front-panel key
Initial S/W Revision:	Prior to A.02.00
Help Map ID:	0

Source (Internal)

Operation of this key is identical across all measurements. For details about this key, see [Source \(Internal\)@35360@i](mailto:Source (Internal)@35360@i).

Key Path:	Front-panel key
Help Map ID:	0

Span X Scale

Accesses a menu of functions that enable you to set the horizontal scale parameters.

Key Path:	Front-panel key
Initial S/W Revision:	A.11.00
Help Map ID:	9055

Ref Value

Sets the X reference value.

Key Path:	SPAN X Scale
Mode:	WCDMA, CDMA2K, EDGE GSM, WIMAX OFDMA, TDSCDMA, CDMA1XEV, LTE, LTETDD, WLAN
Remote Command:	:DISP:SEMask:VIEW[1]:WINDow[1]:TRACe:X[:SCALE]:RLEV l <freq> :DISP:SEMask:VIEW[1]:WINDow[1]:TRACe:X[:SCALE]:RLEV l?
Example:	DISP:SEM:VIEW:WIND:TRAC:X:RLEV 10 DISP:SEM:VIEW:WIND:TRAC:X:RLEV?
Notes:	You must be in the mode that includes SEM measurement to use this command. Use :INSTrument:SELect to set the mode.
Couplings:	If Auto Scaling is set to On, this value is automatically determined by the measurement result. When you set this value manually, Auto Scaling automatically changes to Off.
Preset:	1.0 GHz
State Saved:	Saved in instrument state.
Min:	-1000 GHz
Max:	1000 GHz
Default Unit:	Hz
Initial S/W Revision:	A.11.00
Help Map ID:	9085

Scale/Div

Sets the horizontal scale.

Key Path:	SPAN X Scale
Mode:	WCDMA, CDMA2K, EDGE GSM, WIMAX OFDMA, TDSCDMA, CDMA1XEV, LTE, LTETDD, WLAN
Remote Command:	:DISPlay:SEMask:VIEW[1]:WINDow[1]:TRACe:X[:SCALe]:PDIVi sion <freq> :DISPlay:SEMask:VIEW[1]:WINDow[1]:TRACe:X[:SCALe]:PDIVi sion ?
Example:	DISP:SEM:VIEW:WIND:TRAC:X:PDIV 500 DISP:SEM:VIEW:WIND:TRAC:X:PDIV?
Notes:	You must be in a mode that includes the SEM measurement to use this command. Use INSTRUMENT:SElect to set the mode.
Couplings:	If Auto Scaling is set to On, this value is automatically determined by the measurement result. When you set this value manually, Auto Scaling automatically changes to Off.
Preset:	Automatically Calculated
State Saved:	Yes Saved in instrument state.
Min:	1 Hz
Max:	10.0 GHz
Initial S/W Revision:	A.11.00
Help Map ID:	9086

Ref Position

Sets the reference position for the X axis to Left, Center or Right.

Key Path:	SPAN X Scale
Mode:	WCDMA, CDMA2K, EDGE GSM, WIMAX OFDMA, TDSCDMA, CDMA1XEV, LTE, LTETDD, WLAN
Remote Command:	:DISPlay:SEMask:VIEW[1]:WINDow[1]:TRACe:X[:SCALe]:RPOSi tion LEFT CENTer RIGHT :DISPlay:SEMask:VIEW[1]:WINDow[1]:TRACe:X[:SCALe]:RPOSi tion?
Example:	DISP:SEM:VIEW:WIND:TRAC:X:RPOS LEFT DISP:SEM:VIEW:WIND:TRAC:X:RPOS?

Spectrum Emission Mask Measurement
Span X Scale

Notes:	You must be in a mode that includes the SEM measurement to use this command. Use INSTRUMENT:SElect to set the mode.
Preset:	CENTer
State Saved:	Yes Saved in instrument state.
Range:	Left Ctr Right
Initial S/W Revision:	A.11.00
Help Map ID:	9087

Auto Scaling

Toggles the scale coupling function between On and Off.

Key Path:	SPAN X Scale
Mode:	WCDMA, CDMA2K, EDGE GSM, WIMAX OFDMA, TDSCDMA, CDMA1XEV, LTE, LTE TDD, WLAN
Remote Command:	:DISP:SEMask:VIEW[1]:WINDow[1]:TRACe:X[:SCALE]:COUPl e 0 1 OFF ON :DISP:SEMask:VIEW[1]:WINDow[1]:TRACe:X[:SCALE]:COUPl e?
Example:	DISP:SEM:VIEW:WIND:TRAC:X:COUP ON DISP:SEM:VIEW:WIND:TRAC:X:COUP?
Notes:	You must be in a mode that includes the SEM measurement to use this command. Use INSTRUMENT:SElect to set the mode.
Couplings:	When Auto Scaling is On and the Restart front-panel key is pressed, this function automatically determines the scale per division and reference values based on the measurement results. When you set a value to either Scale/Div or Ref Value manually, Auto Scaling automatically changes to Off.
Preset:	1
State Saved:	Yes Saved in instrument state.
Range:	On Off
Initial S/W Revision:	A.11.00
Help Map ID:	9088

Sweep/Control

Displays a menu that enables you to set up and control the sweep time, gate method, and source of the

current measurement. See [Sweep/Control@3273](#) for more information.

Key Path:	Front-panel key
Initial S/W Revision:	Prior to A.02.00
Help Map ID:	9068

Pause

Pauses a measurement after the current data acquisition is complete. When Paused, the label on the key changes to Resume. Pressing the Resume key resumes the measurement at the point it was at when paused. See [Pause/Resume@3290@i](#) for more details.

Key Path:	Sweep/Control
Initial S/W Revision:	Prior to A.02.00
Help Map ID:	9069

Gate

Accesses a menu that enables you to control the gating function.

The Gate functionality is used to view signals best viewed by qualifying them with other events. See [Gate@3292@i](#) for more details.

Key Path:	Sweep/Control
Initial S/W Revision:	Prior to A.02.00
Help Map ID:	Use 3292

Trace/Detector

Accesses a menu of functions that enable you to control trace and detector for the current measurement.

Key Path:	Front-panel key
Initial S/W Revision:	Prior to A.02.00
Help Map ID:	9060

Trace Type

Allows you to select the type of trace for the current measurement. The menu contains a 1-of-N selection of the trace type (Clear Write, Average, Max Hold, Min Hold).

Key Path:	Trace/Detector
Mode:	WCDMA, C2K, WIMAX OFDMA, TD-SCDMA, 1xEVDO, LTE, LTETDD, WLAN
Remote Command:	:TRACe:SEMask:TYPE WRITe AVERAge MAXHold MINHold :TRACe:SEMask:TYPE?
Example:	TRAC:SEM:TYPE MINH TRAC:SEM:TYPE?
Notes:	WRITe = Clear Write AVERAge = Average MAXHold = Maximum Hold MINHold = Minimum Hold
Couplings:	When Detector setting is “Auto” ([:SENSe]:SEMask:DETEctor:AUTO?), Detector ([:SENSe]:SEMask:DETEctor[:FUNCTio]?) switches aligning with the switch of this parameter: “NORMal” with WRITe (Clear Write), “AVERAge” with AVERAge, “POSitive (peak)” with MAXHold, and “NEGative (peak)” with MINHold.
Preset:	AVERAge
State Saved:	Saved in instrument state.
Range:	WRITe AVERAge MAXHold MINHold
Initial S/W Revision:	Prior to A.02.00
Modified at S/W Revision:	A.02.00, A.03.00
Help Map ID:	9039

Chan Detector

Accesses a menu of functions that enable you to control the detectors for reference channel. The following choices are available:

- Auto- the detector selected depends on marker functions, trace functions, average type, and the trace averaging function.
- Normal-the detector determines the peak of the CW-like signals, and it yields alternating maximums and minimums of noise-like signals. This is also referred to as Rosenfell detection.
- Average-the detector determines the average of the signal within the sweep points. The averaging method depends upon the Average Type selection (voltage, power or log scales).
- Peak-the detector determines the maximum of the signal within the sweep points.
- Sample-the detector indicates the instantaneous level of the signal at the center of the sweep points represented by each display point.
- Negative Peak-the detector determines the minimum of the signal within the sweep points.

Key Path:	Trace/Detector
Initial S/W Revision:	Prior to A.02.00
Help Map ID:	9042

Chan Detector Selection

Selects the detector mode for the reference channel.

Key Path:	Trace/Detector
Mode:	WCDMA, C2K, WIMAX OFDMA, TD-SCDMA, 1xEVDO, LTE, LTETDD, WLAN
Remote Command:	[:SENSE] :SEMAsk :DETector :CARRier [:FUNction] AVERAge NEGAtive NORMAl POSitive SAMPlE [:SENSe] :SEMAsk :DETector :CARRier [:FUNction] ?
Example:	SEM:DET:CARR NEG SEM:DET:CARR?
Notes:	When you manually select a detector (instead of selecting Auto), that detector is used regardless of other analyzer settings. Note: This detector setting affects the reference channel. There is not a per trace detector. You must be in the mode that includes SEM measurement to use this command. Use :INSTrument:SELect to set the mode.
Couplings:	See Couplings in the Trace Type section.
Preset:	AVERAge

Spectrum Emission Mask Measurement
Trace/Detector

State Saved:	Saved in instrument state.
Range:	Normal Average Peak Sample Negative Peak
Initial S/W Revision:	Prior to A.02.00
Modified at S/W Revision:	A.02.00, A.03.00
Help Map ID:	9008

Chan Detector Auto

Sets the detector to the default detection mode for the reference channel. This mode is dependent upon the current reference channel conditions.

Key Path:	Trace/Detector
Mode:	WCDMA, C2K, WIMAX OFDMA, TD-SCDMA, 1xEVDO, LTE, LTETDD, WLAN
Remote Command:	[:SENSE] :SEMAsk :DETector :CARRier :AUTO ON OFF 1 0 [:SENSE] :SEMAsk :DETector :CARRier :AUTO?
Example:	SEM:DET:CARR:AUTO OFF SEM:DET:CARR:AUTO?
Notes:	See Couplings in the Trace Type section. You must be in the mode that includes SEM measurement to use this command. Use :INSTrument:SELect to set the mode.
Preset:	ON
State Saved:	Saved in instrument state
Range:	On Off
Initial S/W Revision:	Prior to A.02.00
Modified at S/W Revision:	A.02.00, A.03.00
Help Map ID:	9076

Offset Detector

Accesses a menu of functions that enable you to control the detector for offsets. The following choices are available.

- Auto- the detector selected depends on marker functions, trace functions, average type, and the trace averaging function.
- Normal-the detector determines the peak of the CW-like signals, and it yields alternating maximums and minimums of noise-like signals. This is also referred to as Rosenfell detection.
- Average-the detector determines the average of the signal within the sweep points. The averaging method depends upon the Average Type selection (voltage, power or log scales).

- Peak-the detector determines the maximum of the signal within the sweep points.
- Sample-the detector indicates the instantaneous level of the signal at the center of the sweep points represented by each display point.
- Negative Peak-the detector determines the minimum of the signal within the sweep points.

Key Path:	Trace/Detector
Initial S/W Revision:	Prior to A.02.00
Help Map ID:	9041

Offset Detector Selection

Selects the detector mode for the offsets.

Key Path:	Trace/Detector
Mode:	WCDMA, C2K, WIMAX OFDMA, TD-SCDMA, 1xEVDO, LTE, LTETDD, WLAN
Remote Command:	[:SENSe] :SEMAsk:DETEctor:OFFSet [:FUNction] AVERAge NEGAtive NORMAl POSitive SAMPlE [:SENSe] :SEMAsk:DETEctor:OFFSet [:FUNction] ?
Example:	SEM:DET:OFFS AVER SEM:DET:OFFS?
Notes:	When you manually select a detector (instead of selecting Auto), that detector is used regardless of other analyzer settings. Note: This detector setting has effects all offsets. There is not a per trace detector. You must be in the mode that includes SEM measurement to use this command. Use :INSTrument:SELEct to set the mode.
Couplings:	See Couplings in the Trace Type section.
Preset:	POSitive
State Saved:	Saved in instrument state.
Range:	Normal Average Peak Sample Negative Peak
Initial S/W Revision:	Prior to A.02.00
Modified at S/W Revision:	A.02.00, A.03.00
Help Map ID:	9075

Offset Detector Auto

Sets the detector to the default detection mode for the offsets. This mode is dependent upon the current

Spectrum Emission Mask Measurement
Trace/Detector

signal conditions of the offsets.

Key Path:	Trace/Detector
Mode:	WCDMA, C2K, WIMAX OFDMA, TD-SCDMA, 1xEVDO, LTE, LTETDD, WLAN
Remote Command:	[:SENSe] :SEMAsk :DETEctor :OFFSet :AUTO ON OFF 1 0 [:SENSe] :SEMAsk :DETEctor :OFFSet :AUTO?
Example:	SEM:DET:OFFS:AUTO OFF SEM:DET:OFFS:AUTO?
Notes:	See Couplings in the Trace Type section. You must be in the mode that includes SEM measurement to use this command. Use :INSTrument:SELEct to set the mode.
Preset:	ON
State Saved:	Saved in instrument state.
Range:	On Off
Initial S/W Revision:	Prior to A.02.00
Modified at S/W Revision:	A.02.00, A.03.00
Help Map ID:	9077

Trigger

Accesses a menu that enables you to select and control the trigger source for the current measurement.

See Trigger@3371@i for more information.

Key Path:	Front-panel key
Initial S/W Revision:	Prior to A.02.00
Help Map ID:	0

View/Display

Accesses a menu of functions that enable you to control the instrument display.

The following keys select how the results are displayed:

- **Abs Pwr Freq**-displays the absolute power levels in dBm and the corresponding frequencies in the text window.
- **Rel Pwr Freq**-displays the relative power levels in dBc and the corresponding frequencies in the text window.
- **Integrated Power**-displays the absolute and relative power levels integrated throughout the bandwidths between the start and stop frequencies in the text window.

[“View Selection by Name \(Remote Command Only\)” on page 652](#)

[“Views Selection by Number \(Remote Command only\)” on page 652](#)

View Selection by Name (Remote Command Only)

Key Path:	View/Display
Mode:	WCDMA, C2K, WIMAX OFDMA, TD-SCDMA, 1xEVDO, LTE, LTETDD, WLAN
Remote Command:	:DISPlay:SEMask:VIEW[:SElect] APFReq RPFReq IPOWER CINformation :DISPlay:SEMask:VIEW[:SElect]?
Example:	DISP:SEM:VIEW IPOW DISP:SEM:VIEW?
Notes:	You must be in the mode that includes SEM measurement to use this command. Use :INSTrument:SElect to set the mode.
Preset:	WCDMA, C2K, TD-SCDMA, 1xEVDO, LTE, LTETDD: APFReq WIMAX OFDMA, WLAN: RPFReq
State Saved:	Saved in instrument state.
Range:	Abs Pwr & Freq Rel Pwr & Freq Integrated Power Carrier Info
Initial S/W Revision:	Prior to A.02.00
Modified at S/W Revision:	A.02.00, A.03.00, A.10.00
Help Map ID:	0

Views Selection by Number (Remote Command only)

The following numerical selections determine how the results are displayed:

1. displays the absolute power levels in dBm and the corresponding frequencies in the text window.

2. displays the relative power levels in dBc and the corresponding frequencies in the text window.
3. displays the absolute and relative power levels integrated throughout the bandwidths between the start and stop frequencies in the text window.

Mode:	WCDMA, C2K, WIMAX OFDMA, TD-SCDMA, 1xEVDO, LTE, LTETDD, WLAN
Remote Command:	:DISPlay:SEMask:VIEW:NSElect <integer> :DISPlay:SEMask:VIEW:NSElect?
Example:	DISP:SEM:VIEW:NSEL 2 DISP:SEM:VIEW:NSEL?
Notes:	You must be in the mode that includes SEM measurement to use this command. Use :INSTrument:SElect to set the mode.
Preset:	WCDMA, C2K, TD-SCDMA, 1xEVDO, LTE, LTETDD: 1 WIMAX OFDMA, WLAN: 2
State Saved:	Saved in instrument state.
Min:	1
Max:	3
Initial S/W Revision:	Prior to A.02.00
Modified at S/W Revision:	A.02.00, A.03.00, A.10.00
Help Map ID:	0

Key Path:	Front-panel key
Initial S/W Revision:	Prior to A.02.00
Help Map ID:	9058

Display

Accesses a menu of functions that enable you to set the display parameters.

See [Display@3440@i](#) for more information.

Key Path:	View/Display
Initial S/W Revision:	Prior to A.02.00
Help Map ID:	0

Change Title

Accesses an Alpha Editor menu that enables you to write a title across the top of the display. This menu contains characters and symbols. that may also be used with the numeric keypad. Press **Enter** or **Return**

Spectrum Emission Mask Measurement
View/Display

to complete the entry. Press **Cancel (Esc)** to cancel the entry and preserve your existing title.

The display title remains until you press **Change Title** again, or you recall a trace or state, or a Factory Preset is performed. A title can also be cleared by pressing **Title, Clear Title**.

See [Display@3447@i](#) for more information.

Key Path:	View/Display, Display, Title
Initial S/W Revision:	Prior to A.02.00
Modified at S/W Revision:	A.02.00, A.03.00
Help Map ID:	0

Abs Pwr Freq

Sets the display to the Absolute Peak Power and Frequency view. The views differ depending on the setting of the measurement type (Meas Type) under the Measurement Setup menu.

“Abs Peak Pwr & Freq (Total Pwr Ref)” on page 655

“Abs Peak Pwr & Freq (PSD Ref)” on page 658

“Abs Peak Pwr & Freq (Spectrum Pk Ref)” on page 660

Abs Peak Pwr & Freq (Total Pwr Ref)

This view consists of the following two windows:

“Trace Window” on page 657

“Results Window ” on page 657

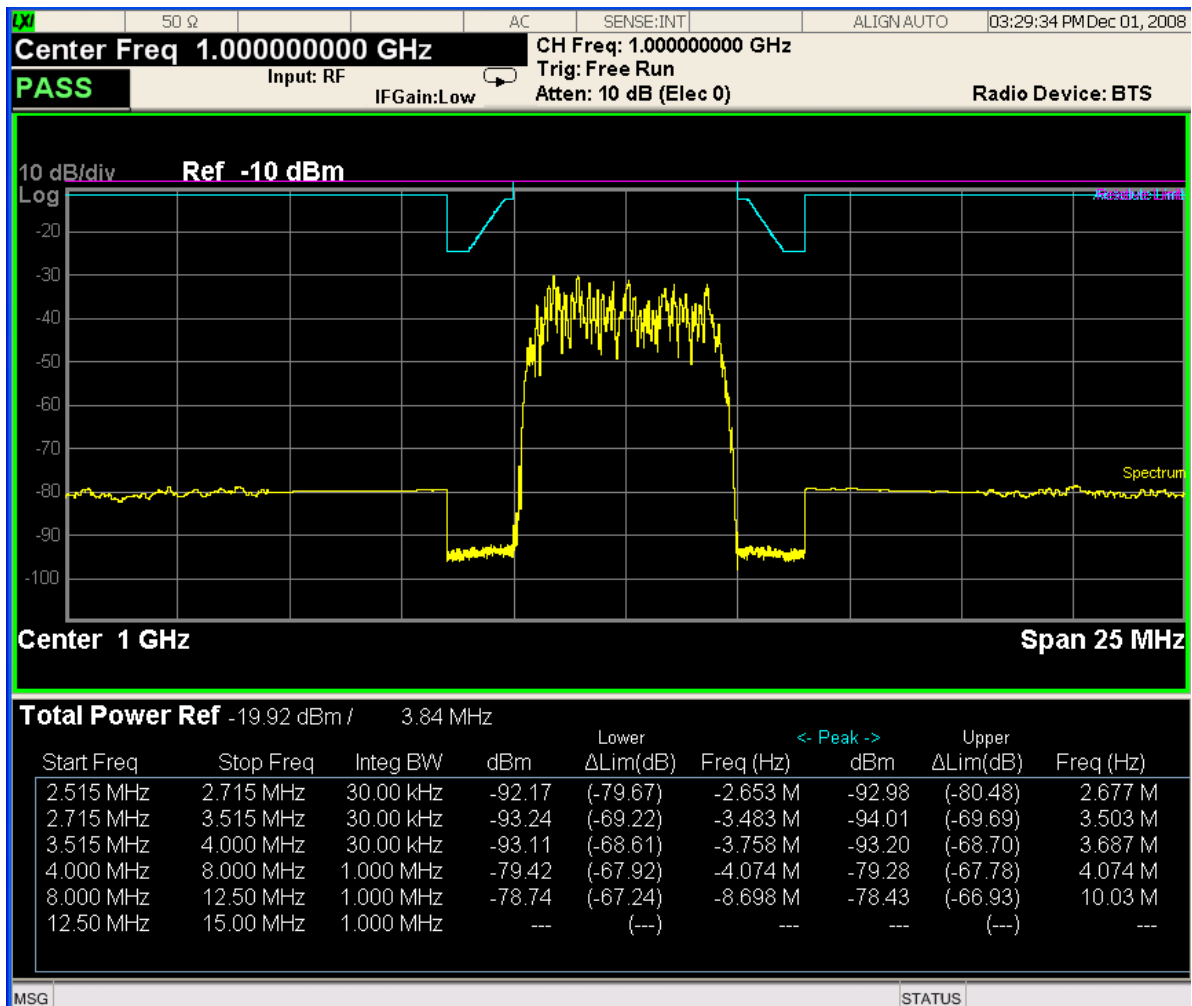

Spectrum Emission Mask Measurement
View/Display

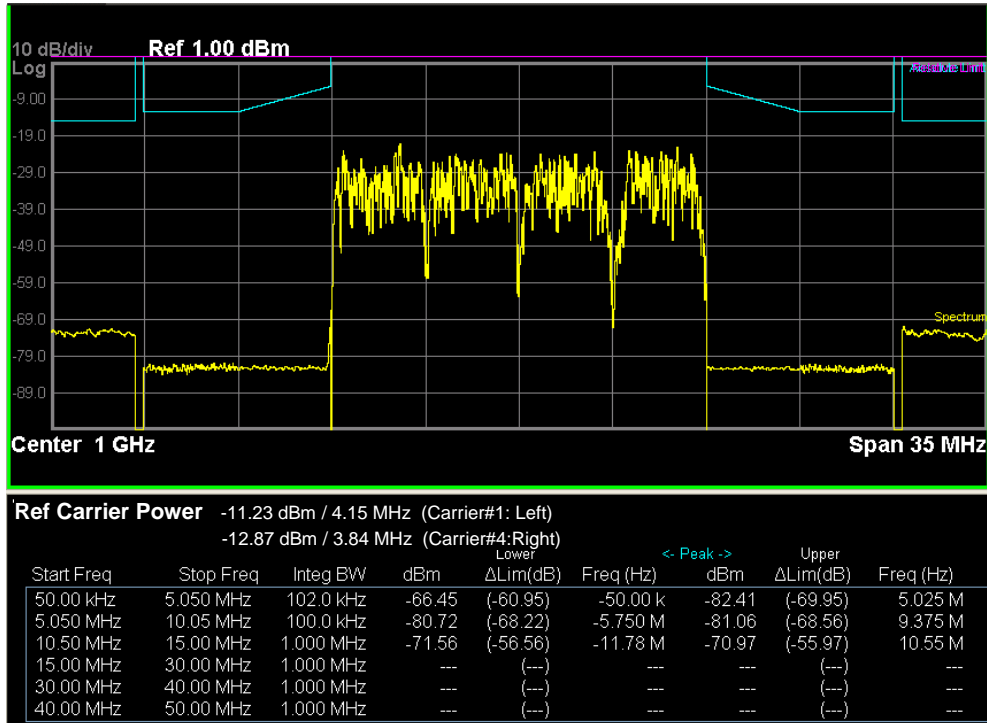

Trace Window

Corresponding Trace	yellow - Combined trace from carrier and each offset
---------------------	--

Results Window

Name	Corresponding Results
Total Pwr Ref	n=1 2nd element Absolute power at the reference area.
	Channel Integration Bandwidth
Start (Hz)	Start frequency for offset
Stop (Hz)	Stop frequency for offset
Meas BW (Hz)	Measurement bandwidth for offset
Lower Peak (dBm)	Absolute peak power on minimum margin point of the negative offset
Lower lim (dB)	Minimum margin from limit line which is decided by Fail Mask setting on the negative offset
Lower Freq (Hz)	Frequency on minimum margin point of the negative offset
Upper Peak (dBm)	Absolute peak power on minimum margin point of the positive offset
Upper lim (dB)	Minimum margin from limit line which is decided by Fail Mask setting on the positive offset
Upper Freq (Hz)	Frequency on minimum margin point of the positive offset

Spectrum Emission Mask Measurement
View/Display

Abs Peak Pwr & Freq (PSD Ref)

This view consists of the following two windows:

“Trace Window” on page 660

“Results Window ” on page 660

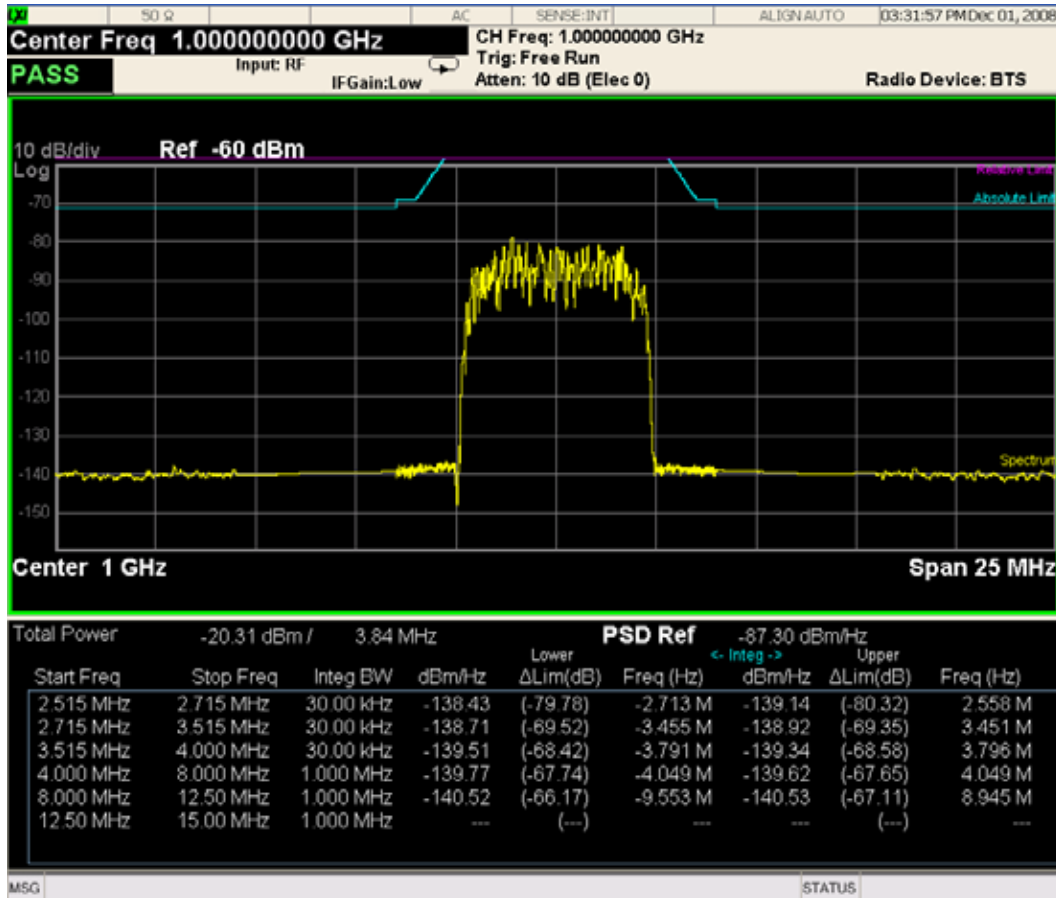

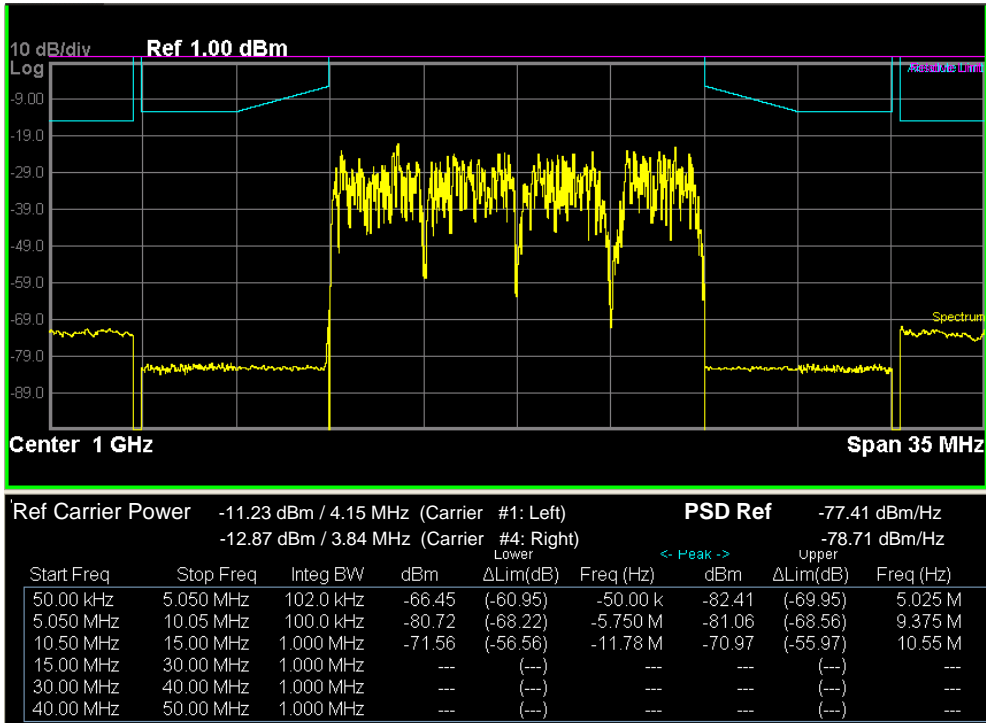

Trace Window

Corresponding Trace	yellow - Combined trace from carrier and each offset
---------------------	--

Results Window

Name	Corresponding Results
Total Pwr	n=1 2nd element Absolute power at the reference area.
	Channel Integration Bandwidth
PSD Ref	n=5 1st element Power spectral density reference at the reference area
Start (Hz)	Start frequency for offset
Stop (Hz)	Stop frequency for offset
Meas BW (Hz)	Measurement bandwidth for offset
Lower (dBm/Hz)	Absolute power spectrum density of the negative offset
Lower lim (dB)	Minimum margin from limit line which is decided by Fail Mask setting on the negative offset
Lower Freq (Hz)	Frequency on minimum margin point of the negative offset
Upper (dBm/Hz)	Absolute power spectrum density of the positive offset
Upper lim (dB)	Minimum margin from limit line which is decided by Fail Mask setting on the positive offset
Upper Freq (Hz)	Frequency on minimum margin point of the positive offset

Abs Peak Pwr & Freq (Spectrum Pk Ref)

This view consists of the following two windows:

“Trace Window” on page 660

“Results Window ” on page 660

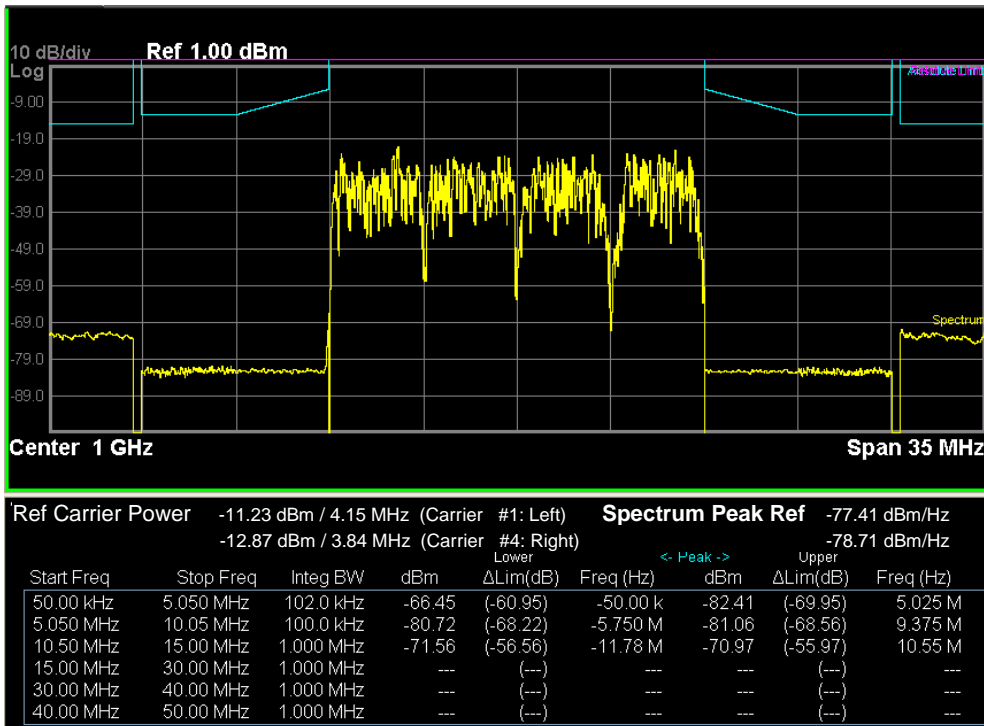
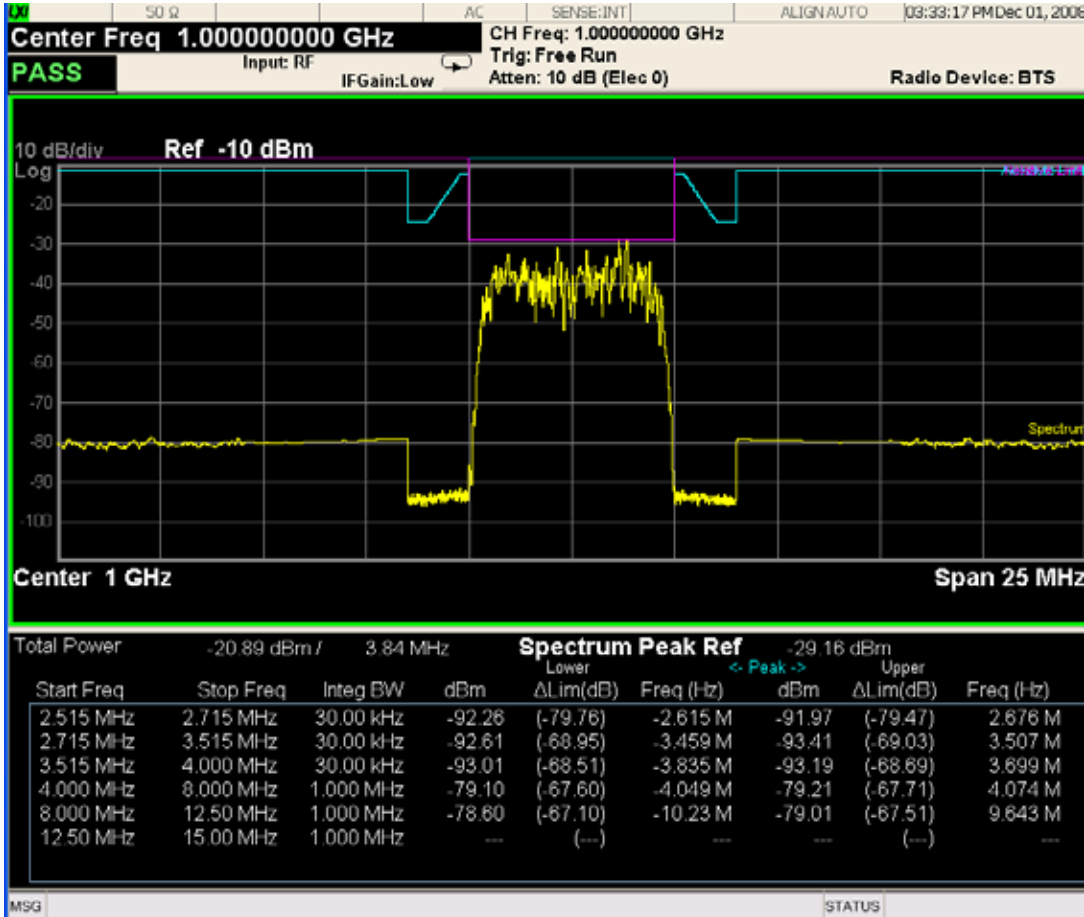

Trace Window

Corresponding Trace	yellow - Combined trace from carrier and each offset
---------------------	--

Results Window

Name	Corresponding Results
Total Pwr	Absolute power at the reference area.
	Channel Integration Bandwidth
Spectrum Peak Ref	n=5 1st element Spectrum peak power reference at the reference area
Start (Hz)	Start frequency for offset
Stop (Hz)	Stop frequency for offset
Meas BW (Hz)	Measurement bandwidth for offset
Lower(dBm)	Absolute peak power on minimum margin point of the negative offset
Lower lim (dB)	Minimum margin from limit line which is decided by Fail Mask setting on the negative offset
Lower Freq (Hz)	Frequency on minimum margin point of the negative offset
Upper (dBm)	Absolute peak power on minimum margin point of the positive offset
Upper lim (dB)	Minimum margin from limit line which is decided by Fail Mask setting on the positive offset
Upper Freq (Hz)	Frequency on minimum margin point of the positive offset

Key Path:	View/Display
Initial S/W Revision:	Prior to A.02.00
Help Map ID:	9004

Rel Pwr Freq

Sets the display to the Relative Peak Power and Frequency view. The views differ depending on the setting of the measurement type (Meas Type) under the Measurement Setup menu.

[“Rel Peak Pwr & Freq \(Total Pwr Ref\)” on page 663](#)

[“Rel Peak Pwr & Freq \(PSD Ref\)” on page 665](#)

[“Rel Peak Pwr & Freq \(Spectrum Pk Ref\)” on page 667](#)

Rel Peak Pwr & Freq (Total Pwr Ref)

This view consists of the following two windows:

“Trace Window” on page 664

“Results Window” on page 664

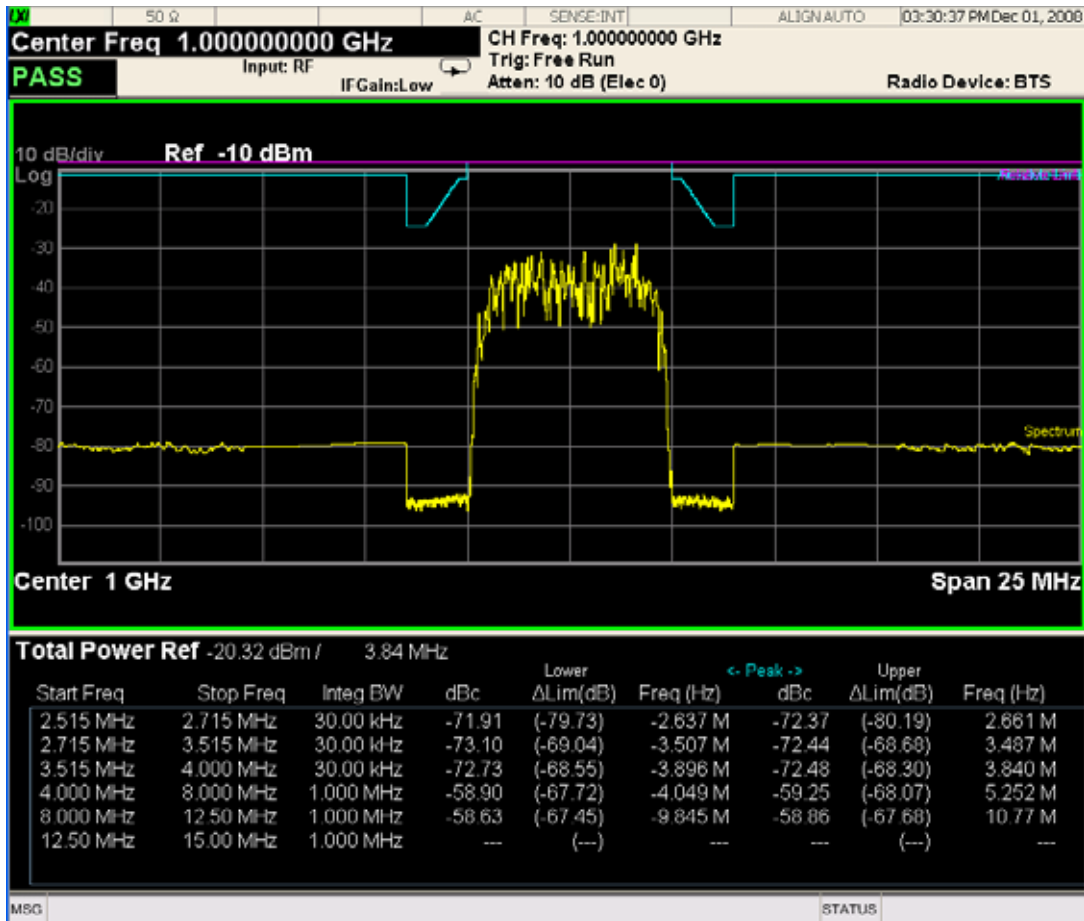

Trace Window

Corresponding Trace	yellow - Combined trace from carrier and each offset
---------------------	--

Results Window

Name	Corresponding Results
Total Pwr Ref	n=1 2nd element Absolute power at the reference area.
	Channel Integration Bandwidth
Start (Hz)	Start frequency for offset
Stop (Hz)	Stop frequency for offset
Meas BW (Hz)	Measurement bandwidth for offset
Lower Peak (dBc)	Relative peak power on minimum margin point of the negative offset
Lower Lim (dB)	Minimum margin from limit line which is decided by Fail Mask setting on the negative offset
Lower Freq (Hz)	Frequency on minimum margin point of the negative offset
Upper Peak (dBc)	Relative peak power on minimum margin point of the positive offset
Upper Lim (dB)	Minimum margin from limit line which is decided by Fail Mask setting on the positive offset
Upper Freq (Hz)	Frequency on minimum margin point of the positive offset

Rel Peak Pwr & Freq (PSD Ref)

This view consists of the following two windows:

“Trace Window” on page 666

“Results Window” on page 666

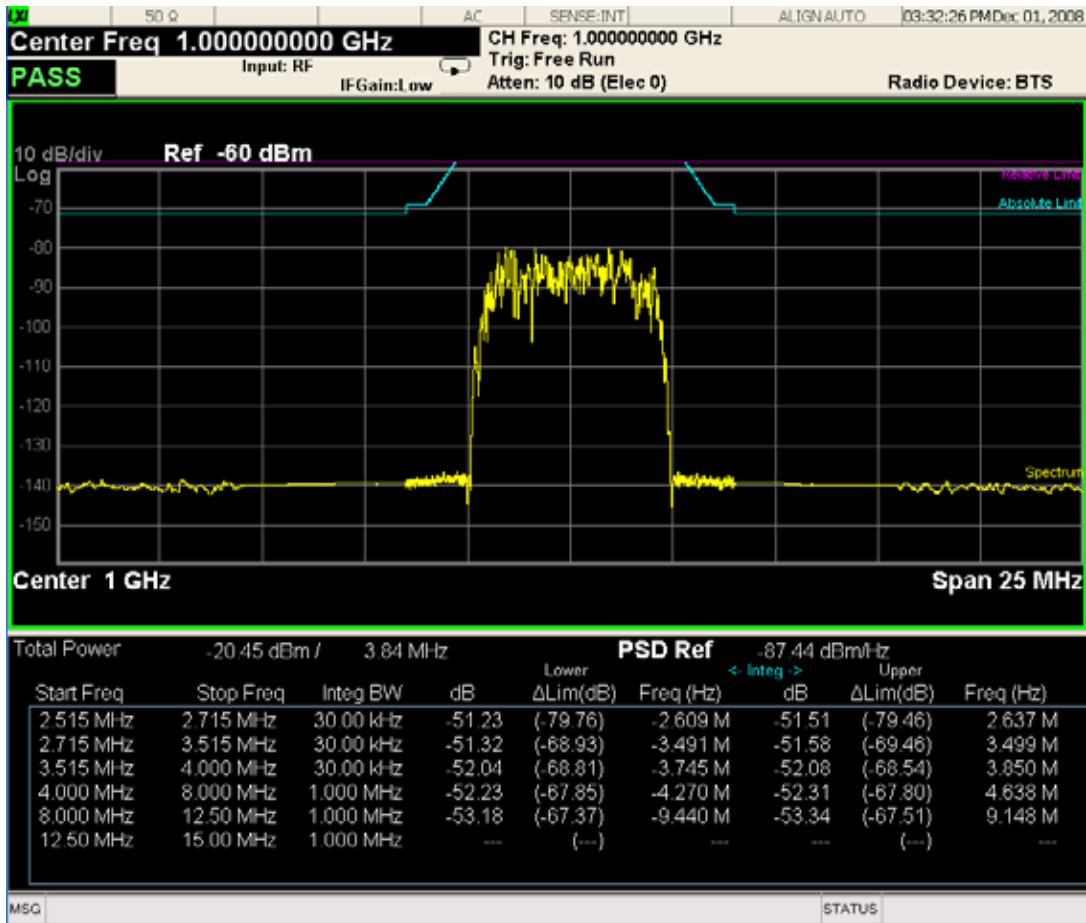

Trace Window

Corresponding Trace	yellow - Combined trace from carrier and each offset
---------------------	--

Results Window

Name	Corresponding Results
Total Pwr	n=1 2nd element Absolute power at the reference area.
	Channel Integration Bandwidth
PSD Ref	n=5 1st element Power spectral density reference at the reference area
Start (Hz)	Start frequency for offset
Stop (Hz)	Stop frequency for offset
Meas BW (Hz)	Measurement bandwidth for offset
Lower (dB)	Relative power spectrum density of the negative offset
Lower Lim (dB)	Minimum margin from limit line which is decided by Fail Mask setting on the negative offset
Lower Freq (Hz)	Frequency on minimum margin point of the negative offset
Upper (dB)	Relative power spectrum density of the positive offset
Upper Lim (dB)	Minimum margin from limit line which is decided by Fail Mask setting on the positive offset
Upper Freq (Hz)	Frequency on minimum margin point of the positive offset

Rel Peak Pwr & Freq (Spectrum Pk Ref)

This view consists of the following two windows:

“Trace Window” on page 664

“Results Window” on page 664

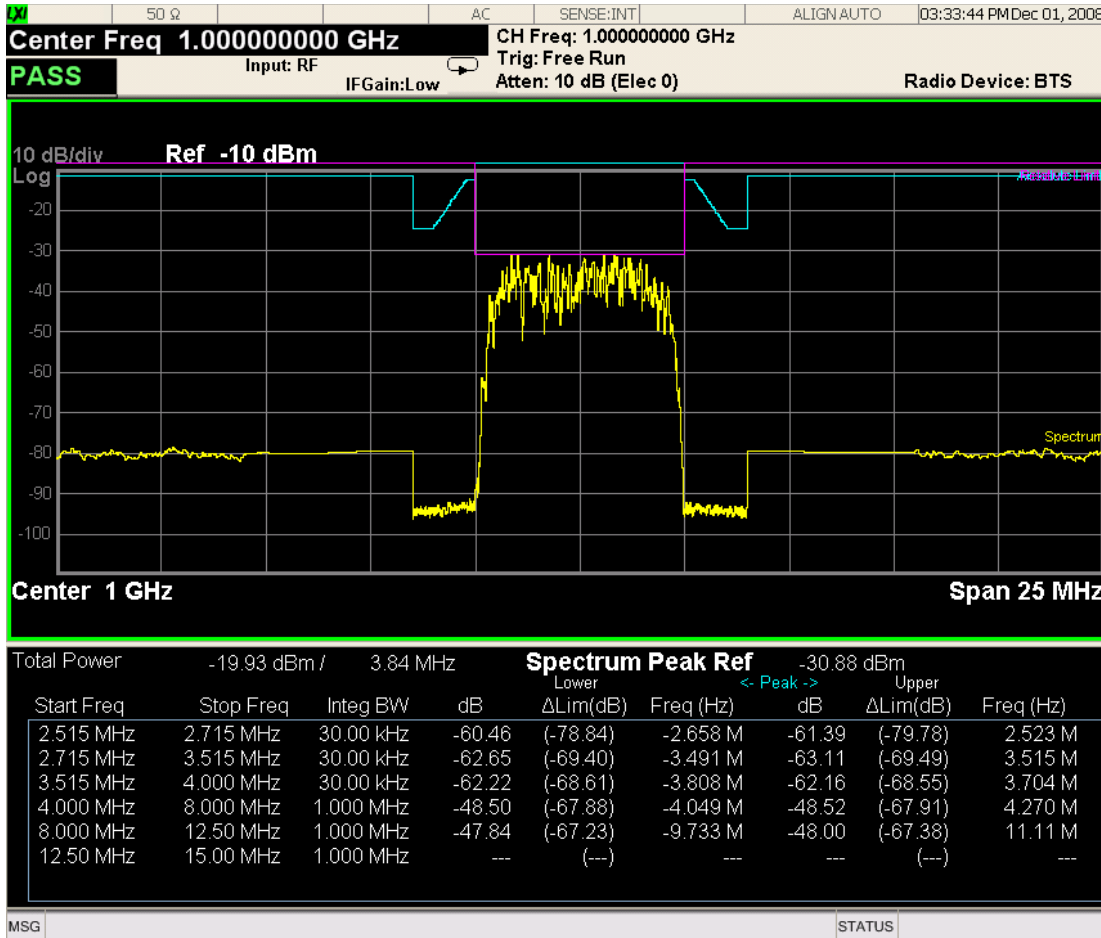

Trace Window

Corresponding Trace	yellow - Combined trace from carrier and each offset
---------------------	--

Results Window

Name	Corresponding Results
Total Pwr	Absolute power at the reference area.
	Channel Integration Bandwidth
Spectrum Peak Ref	n=5 1st element Spectrum peak power reference at the reference area
Start (Hz)	Start frequency for offset
Stop (Hz)	Stop frequency for offset
Meas BW (Hz)	Measurement bandwidth for offset
Lower Peak (dB)	Relative peak power on minimum margin point of the negative offset
Lower Lim (dB)	Minimum margin from limit line which is decided by Fail Mask setting on the negative offset
Lower Freq (Hz)	Frequency on minimum margin point of the negative offset
Upper Peak (dB)	Relative peak power on minimum margin point of the positive offset
Upper Lim (dB)	Minimum margin from limit line which is decided by Fail Mask setting on the positive offset
Upper Freq (Hz)	Frequency on minimum margin point of the positive offset

Key Path:	View/Display
Initial S/W Revision:	Prior to A.02.00
Help Map ID:	9005

Integrated Power

Sets the display to the Integrated Power view. The views differ depending on the setting of the measurement type (Meas Type) under the Measurement Setup menu.

“Integrated Power (Total Pwr Ref)” on page 669

“Integrated Power (PSD Ref)” on page 672

“Integrated Power (Spectrum Pk Ref)” on page 675

Integrated Power (Total Pwr Ref)

“Trace Window” on page 671

“Results Window” on page 671

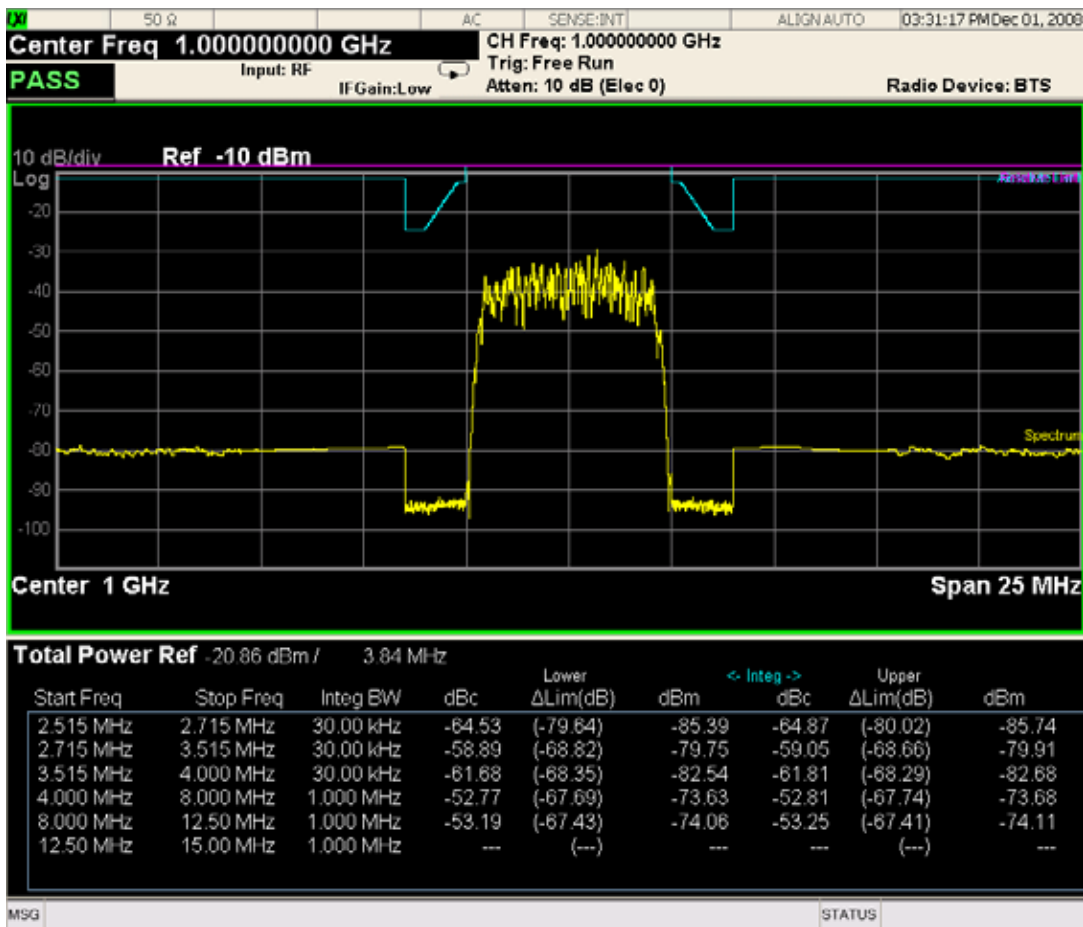

Spectrum Emission Mask Measurement
View/Display

For WLAN 802.11ac (80 + 80 MHz), power readouts of both of the carriers are displayed in the lower result window.



Trace Window

Corresponding Trace	yellow - Combined trace from carrier and each offset
---------------------	--

Results Window

Name	Corresponding Results
Total Pwr Ref	n=1 2nd element Absolute power at the reference area.
	Channel Integration Bandwidth
Start (Hz)	Start frequency for offset
Stop (Hz)	Stop frequency for offset
Meas BW (Hz)	Measurement bandwidth for offset
Lower Integ (dBc)	Relative integrated power on the negative offset
Lower Lim (dB)	Minimum margin from limit line which is decided by Fail Mask setting on the negative offset
Lower Integ (dBm)	Absolute integrated power on the negative offset
Upper Integ (dBc)	Relative integrated power on the positive offset
Upper Lim (dB)	Minimum margin from limit line which is decided by Fail Mask setting on the positive offset
Upper Integ (dBm)	Absolute integrated power on the positive offset

Spectrum Emission Mask Measurement
View/Display

Integrated Power (PSD Ref)

“Trace Window” on page 674

“Results Window” on page 674

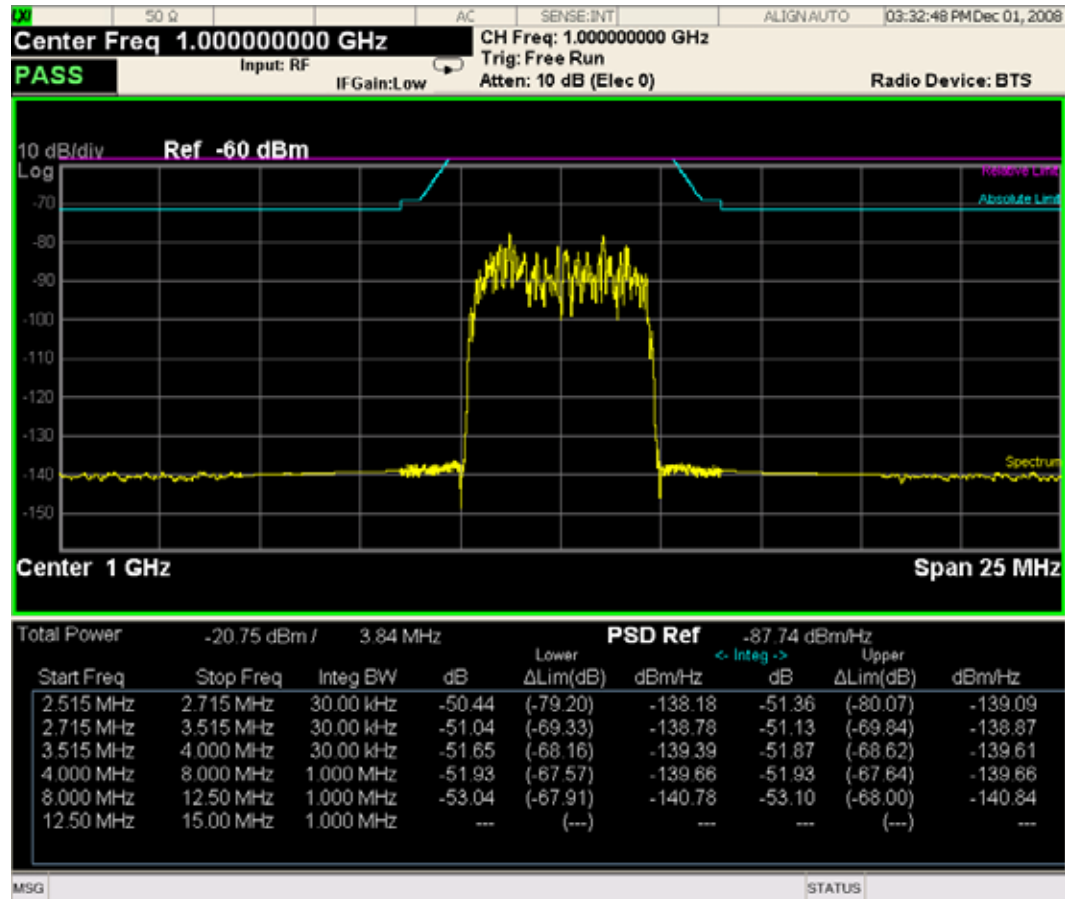

For WLAN 802.11ac (80 + 80 MHz), power readouts of both of the carriers are displayed in the lower result window.



Trace Window

Corresponding Trace	yellow - Combined trace from carrier and each offset
---------------------	--

Results Window

Name	Corresponding Results
Total Pwr	n=1 2nd element Absolute power at the reference area.
	Channel Integration Bandwidth
PSD Ref	n=5 1st element Power spectral density reference at the reference area
Start (Hz)	Start frequency for offset
Stop (Hz)	Stop frequency for offset
Meas BW (Hz)	Measurement bandwidth for offset
Lower (dB)	Relative power spectrum density of the negative offset
Lower Lim (dB)	Minimum margin from limit line which is decided by Fail Mask setting on the negative offset
Lower (dBm/Hz)	Absolute power spectrum density of the negative offset
Upper (dB)	Relative power spectrum density of the positive offset
Upper Lim (dB)	Minimum margin from limit line which is decided by Fail Mask setting on the positive offset
Upper (dBm/Hz)	Absolute power spectrum density of the negative offset

Integrated Power (Spectrum Pk Ref)

Trace Window

“Results Window” on page 671

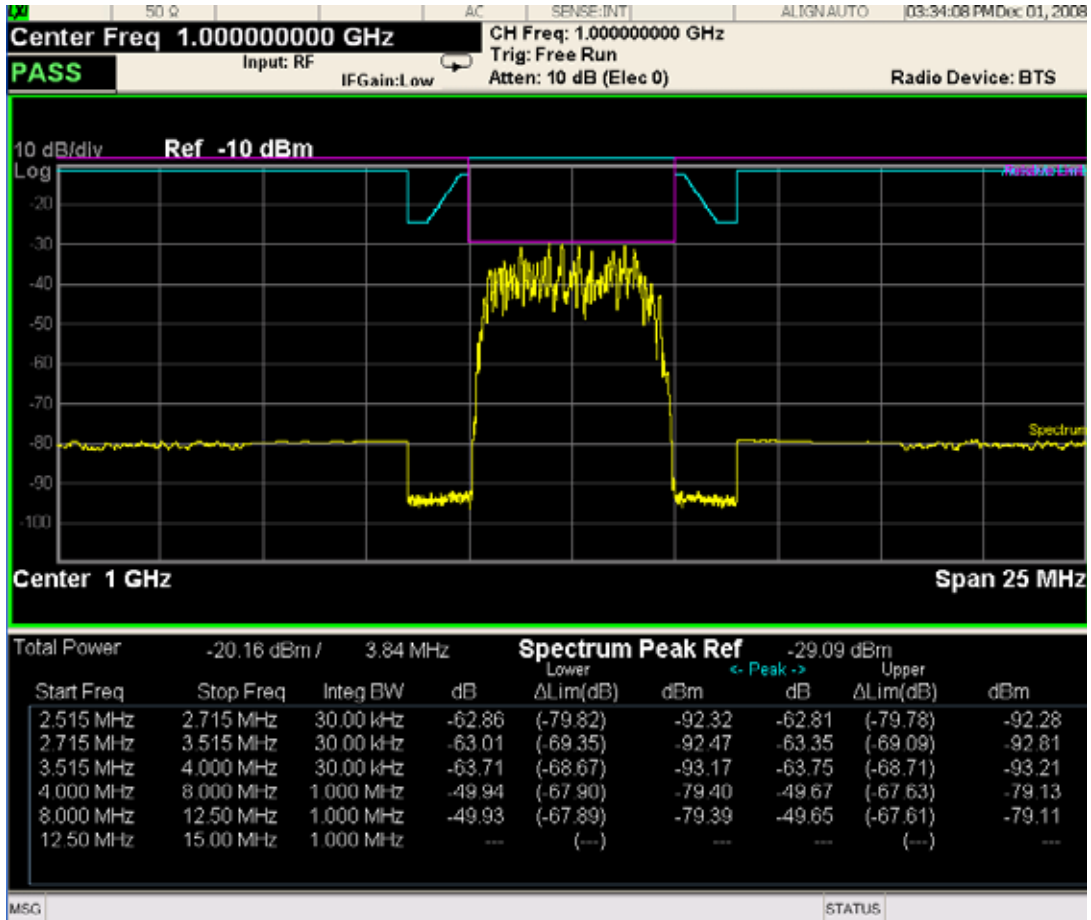

Spectrum Emission Mask Measurement
View/Display

For WLAN 802.11ac (80 + 80 MHz), power readouts of both of the carriers are displayed in the lower result window.



Trace Window

Corresponding Trace	yellow - Combined trace from carrier and each offset
---------------------	--

Results Window

Name	Corresponding Results
Total Pwr	Absolute power at the reference area.
	Channel Integration Bandwidth
Spectrum Peak Ref	n=5 1st element Peak power at the reference area
Start (Hz)	Start frequency for offset
Stop (Hz)	Stop frequency for offset
Meas BW (Hz)	Measurement bandwidth for offset
Lower Peak (dB)	Relative peak power on minimum margin point of the negative offset
Lower lim (dB)	Minimum margin from limit line which is decided by Fail Mask setting on the negative offset
Lower Peak (dBm)	Absolute peak power on minimum margin point of the negative offset
Upper Peak (dB)	Relative peak power on minimum margin point of the positive offset
Upper lim (dB)	Minimum margin from limit line which is decided by Fail Mask setting on the positive offset
Upper Peak (dBm)	Absolute peak power on minimum margin point of the positive offset

Key Path:	View/Display
Initial S/W Revision:	Prior to A.02.00
Help Map ID:	9047

Limit Lines

Toggles the limit lines display function for the spectrum emission mask measurements On and Off.

Key Path:	View/Display
Mode:	WCDMA, C2K, WIMAX OFDMA, TD-SCDMA, 1xEVDO, LTE, LTETDD, WLAN

Spectrum Emission Mask Measurement
View/Display

Remote Command:	:CALCulate:SEMask:LLINe:STATe ON OFF 1 0 :CALCulate:SEMask:LLINe:STATe?
Example:	CALC:SEM:LLIN:STAT OFF CALC:SEM:LLIN:STAT?
Notes:	You must be in the mode that includes SEM measurement to use this command. Use :INSTrument:SElect to set the mode.
Preset:	ON
State Saved:	Saved in instrument state.
Range:	On Off
Initial S/W Revision:	Prior to A.02.00
Modified at S/W Revision:	A.02.00, A.03.00
Help Map ID:	9006

This measurement is designed for testing Transmit On/Off power for the E-UTRA TDD BS, E-UTRA TDD UE and E-UTRA FDD UE. You must be in the LTE or LTETDD mode to use these commands.

For the measurement results and views, see [“View/Display” on page 735](#).

This topic contains the following sections.

[“Remote Commands for Transmit On/Off power” on page 679](#) Transmit On/Off power

[“Measurement Results for Transmit On/Off power Measurement” on page 679](#) Transmit On/Off power Measurement

Remote Commands for Transmit On/Off power

The following commands are used to retrieve the measurement results:

:CONFigure:PVTime

:CONFigure:PVTime:NDEFault

:INITiate:PVTime

:FETCh:PVTime [n] ?

:READ:PVTime [n] ?

:MEASure:PVTime [n] ?

For more measurement related commands, see the SENSE subsystem, and the section [Remote Measurement Functions@29978](#).

Measurement Results for Transmit On/Off power Measurement

For each result, the following heading is used to represent its format and precision.

#.Result Name (type of number) [unit] <explanation>

Type of number includes double, float and integer.

Index n	Results Returned
0	Returns unprocessed I/Q trace data as a series of comma-separated trace point values, in volts. The I values are listed first in each pair, using 0 through the even-indexed values. The Q values are odd-indexed values.

Index n	Results Returned
n=1 (or not specified)	<p>Returns the following comma-separated scalar results:</p> <p>Sample time is a floating point number representing the time between samples of displayed trace which you can get by using the trace queries (n=2, 3, ...).</p> <p>Number of samples is the number of data points in the displayed trace. This number is useful when performing a query on the signal (i.e. when n=2, 3, ...).</p> <p>On Power/ Mean Power of First SRS Symbol is the mean power (in dBm) of the active part in the range specified by Analysis Time Slot and Measured Time Slots in the most recently acquired data, or in the last data acquired at the end of a set of averages. For LTETDD, When Direction is Uplink and Measure Dual SRS is selected, this result will be the mean power of the first SRS symbol.</p> <p>Burst width is the width of the first set of continuous active slots in the range specified by Analysis Time slot and Measured Time Slots.</p> <p>Trigger Diff is the time difference between the position of the trigger line and the start point of the start slot specified by Analysis Time Slot.</p> <p>Ramp up time is the time difference between 10% and 90% voltage points (relative to peak) on the positive slope of the burst, here burst has the same meaning in Burst width.</p> <p>Ramp down time is the time difference between 90% and 10% voltage points (relative to peak) on the negative slope of the burst, here burst has the same meaning in Burst width.</p> <p>Off power/Off power before is the mean power measured during the transmitter OFF period, When Direction is Uplink, this result is the OFF power during the sub-frame prior to the active subframe.</p> <p>Maximum power is the maximum peak level in the range specified by Analysis Time Slot and Measured Time Slots (in dBm).</p> <p>Minimum power is the minimum peak level in the range specified by Analysis Time Slot and Measured Time Slots (in dBm).</p> <p>Actual sample time is the a floating point number representing the time between samples of uncompressed I/Q trace data, which could be get by using trace query(n=0).</p> <p>Actual number of samples is the number of data points in the uncompressed I/Q trace data, which could be get by using trace query(n=0).</p> <p>Off power after This result is Uplink only. It is the OFF power during the sub-frame following the active subframe. When Direction is not Uplink, the value will be NaN (9.91 E 37).</p> <p>Mean Power of Second SRS Symbol. For LTETDD, When Direction is Uplink and Measure Dual SRS is selected, this result will be the mean power of the second SRS symbol. When Direction is not Uplink and Meas DualSRS is not selected, the value will be NaN (9.91 E 37).</p>
2	<p>Measured Trace data This returns comma-separated floating point numbers representing the Measured Trace data (in dBm).</p>
3	<p>Measured Max Hold Trace data This returns comma-separated floating point numbers representing the Measured Max Hold Trace data (in dBm).</p>

Index n	Results Returned
4	<p>Measured Min Hold Trace data This returns comma-separated floating point numbers representing the Measured Min Hold Trace data (in dBm).</p>
5	<p>Averaged absolute power of the slots This returns at most 20 comma-separated float values representing the averaged absolute power of each time slot (in dBm). For the inactive slot, the value will be NaN (9.91 E 37)..</p> <p>Averaged absolute power of TS0 Averaged absolute power of TS1 Averaged absolute power of DwPTS Averaged absolute power of UpPTS Averaged absolute power of TS4 Averaged absolute power of TS5 Averaged absolute power of TS6 Averaged absolute power of TS7 Averaged absolute power of TS8 Averaged absolute power of TS9 Averaged absolute power of TS10 Averaged absolute power of TS11 Averaged absolute power of TS12 (if the Uplink-downlink configuration indicates it is 5ms periodicity, it is 2nd DwPTS) Averaged absolute power of TS13(if the Uplink-downlink configuration indicates it is 5ms periodicity, it is 2nd UpPTS) Averaged absolute power of TS14 Averaged absolute power of TS15 Averaged absolute power of TS16 Averaged absolute power of TS17 Averaged absolute power of TS18 Averaged absolute power of TS19</p>

Index n	Results Returned
6	<p>Width of the slots</p> <p>This returns 20 comma-separated float values representing the width of each time slot (in us). For the inactive slot, the value will be NaN(9.91E37).</p> <p>Active signal width of TS0</p> <p>Active signal width of TS1</p> <p>Active signal width of DwPTS</p> <p>Active signal width of UpPTS</p> <p>Active signal width of TS4</p> <p>Active signal width of TS5</p> <p>Active signal width of TS6</p> <p>Active signal width of TS7</p> <p>Active signal width of TS8</p> <p>Active signal width of TS9</p> <p>Active signal width of TS10</p> <p>Active signal width of TS11</p> <p>Active signal width of TS12 (if the Uplink-downlink configuration indicates it is 5ms periodicity, it is 2nd DwPTS)</p> <p>Active signal width of TS13(if the Uplink-downlink configuration indicates it is 5ms periodicity, it is 2nd UpPTS)</p> <p>Active signal width of TS14</p> <p>Active signal width of TS15</p> <p>Active signal width of TS16</p> <p>Active signal width of TS17</p> <p>Active signal width of TS18</p> <p>Active signal width of TS19</p>

Index n	Results Returned
7	<p>Averaged absolute power of the subframes</p> <p>This returns 10 comma-separated float values, for active subframe, it represents mean power (in dBm) of each subframe excluding any transient time, for inactive subframe, it represents the OFF power. For subframes not included in the specified measure interval, the value will be NaN(9.91E37). For special subframes in LTETDD, when Direction is Downlink, it will be the mean power in DwPTS, when Direction is Uplink, it will be the mean power of UpPTS.</p> <p>Averaged absolute power of Subframe 0</p> <p>Averaged absolute power of Subframe 1</p> <p>Averaged absolute power of Subframe 2</p> <p>Averaged absolute power of Subframe 3</p> <p>Averaged absolute power of Subframe 4</p> <p>Averaged absolute power of Subframe 5</p> <p>Averaged absolute power of Subframe 6</p> <p>Averaged absolute power of Subframe 7</p> <p>Averaged absolute power of Subframe 8</p> <p>Averaged absolute power of Subframe 9</p>
8	<p>Averaged Width of the subframes</p> <p>This returns 10 comma-separated float values representing burst width (in us) of each subframe. For special subframes in LTETDD, when Direction is Downlink, it will be the burst width of DwPTS, when Direction is Uplink, it will be the burst width of UpPTS.</p> <p>For the inactive subframe, the value will be NaN(9.91E37)</p> <p>Active signal width of Subframe 0</p> <p>Active signal width of Subframe 1</p> <p>Active signal width of Subframe 2</p> <p>Active signal width of Subframe 3</p> <p>Active signal width of Subframe 4</p> <p>Active signal width of Subframe 5</p> <p>Active signal width of Subframe 6</p> <p>Active signal width of Subframe 7</p> <p>Active signal width of Subframe 8</p> <p>Active signal width of Subframe 9</p>

Key Path:	Front-panel key
Initial S/W Revision:	A.03.00
Help Map ID:	40703

Amplitude (AMPTD) Y Scale

The AMPLITUDE Y Scale key accesses the menu to set the desired vertical scale and associated settings.

Key Path:	Front-panel key
Initial S/W Revision:	A.03.00
Help Map ID:	40650

Ref Value (Burst View)

Sets the absolute power reference.

Key Path:	AMPTD Y Scale
Mode:	LTETDD, LTE
Remote Command:	:DISPlay:PVTime:VIEW[1]:WINDow[1]:TRACe:Y[:SCALe]:RLEVe l <real> :DISPlay:PVTime:VIEW[1]:WINDow[1]:TRACe:Y[:SCALe]:RLEVe l?
Example:	DISP:PVT:VIEW:WIND:TRAC:Y:SCAL:RLEV 5dbm DISP:PVT:VIEW:WIND:TRAC:Y:SCAL:RLEV?
Couplings:	When Y Auto Scale is set to On, this value is automatically determined by the measurement result. When you set this value manually, Y Auto Scale is automatically set to Off.
Preset:	10.00
State Saved:	Saved in instrument state.
Min:	-250.0
Max:	250.0
Initial S/W Revision:	A.03.00
Help Map ID:	40651

Ref Value (Rise & Fall view)

Allows you to set the absolute power reference.

Key Path:	AMPTD Y Scale
Mode:	LTETDD, LTE

Remote Command:	:DISPlay:PVT:ime:VIEW2:WINDow[1] 2:TRACe:Y[:SCALe]:RLEVe l <real> :DISPlay:PVT:ime:VIEW2:WINDow[1] 2:TRACe:Y[:SCALe]:RLEVe l?
Example:	DISP:PVT:VIEW:WIND:TRAC:Y:SCAL:RLEV 5 DISP:PVT:VIEW:WIND:TRAC:Y:SCAL:RLEV?
Couplings:	When Y Auto Scaling is On, this value is automatically determined by the measurement result. When the user sets this value manually, Y Auto Scaling automatically changes to Off.
Preset:	0.00 dBm
State Saved:	Saved in instrument state.
Min:	-250.0
Max:	250.0
Initial S/W Revision:	A.03.00
Help Map ID:	40707

Attenuation

This menu controls both the electrical and mechanical attenuators and their interactions. The value read back on the key in square brackets is the current Total (Elec + Mech) attenuation. When in Pre-Adjust for Min Clip mode, this value can change at the start of every measurement.

Operation of this key is identical across several measurements. For details about this key, see [Attenuation@3003](#) in the "Common Measurement Functions".

Scale/Div(Burst View)

Allows you to enter a numeric value to change the vertical display sensitivity.

Key Path:	AMPTD Y Scale
Mode:	LTETDD, LTE
Remote Command:	:DISPlay:PVT:ime:VIEW[1]:WINDow[1]:TRACe:Y[:SCALe]:PDIVi sion <rel_ampl> :DISPlay:PVT:ime:VIEW[1]:WINDow[1]:TRACe:Y[:SCALe]:PDIVi sion?
Example:	DISP:PVT:VIEW:WIND:TRAC:Y:PDIV 5 dB DISP:PVT:VIEW:WIND:TRAC:Y:PDIV?

Transmit On/Off Power Measurement
Amplitude (AMPTD) Y Scale

Couplings:	When the Auto Scale is On, this value is automatically determined by the measurement result. When you set a value manually, Auto Scale automatically changes to Off.
Preset:	10.00 dB
State Saved:	Saved in instrument state.
Min:	0.10 dB
Max:	20.00 dB
Initial S/W Revision:	A.03.00
Help Map ID:	40652

Scale/Div (Rise & Fall view)

Allows you to enter a numeric value to change the vertical display sensitivity.

Parameter Name:	Y Scale/Div
Key Path:	AMPTD Y Scale
Parameter Type:	Float32 A6
Mode:	LTETDD, LTE
Remote Command:	:DISPlay:PVTTime:VIEW2:WINDow[1] 2:TRACe:Y[:SCALe] :PDIVi sion <rel_ampl> :DISPlay:PVTTime:VIEW2:WINDow[1] 2:TRACe:Y[:SCALe] :PDIVi sion?
Example:	DISP:PVT:VIEW:WIND:TRAC:Y:PDIV 10 DISP:PVT:VIEW:WIND:TRAC:Y:PDIV?
Couplings:	When Y Auto Scaling is On, this value is automatically determined by the measurement result. When the user sets this value manually, Y Auto Scaling automatically changes to Off.
Preset:	10.00
Force Restart:	No
State Saved:	Saved in instrument state.
Min:	0.1
Max:	20.0
Test MIN/MAX/DEF:	Yes
Resolution:	0.1
Knob Increment:	0.1 dB

Test UP/DOWN:	1, 2, 5, 10 ...
Unit Terminator Key:	dB
Softkey Label:	Scale/Div
Annotation:	<value> dB/ left upper of graph
Initial S/W Revision:	A.03.00
Help Map ID:	40708

Internal Preamp

Operation of this key is identical across several measurements. For details about this key, see [Internal Preamp@3036@i](#) in the "Common Measurement Functions".

Ref Position(Burst View)

Allows you to set the display reference position to the top, center, or bottom of the display.

Key Path:	AMPTD Y Scale, More
Mode:	LTETDD, LTE
Remote Command:	:DISPlay:PVTime:VIEW[1]:WINDow[1]:TRACe:Y[:SCALe]:RPOSi tion TOP CENTer BOTTom :DISPlay:PVTime:VIEW[1]:WINDow[1]:TRACe:Y[:SCALe]:RPOSi tion?
Example:	:DISP:PVT:VIEW:WIND:TRAC:Y:SCAL:RPOS CENT :DISP:PVT:VIEW:WIND:TRAC:Y:SCAL:RPOS?
Preset:	TOP
State Saved:	Saved in instrument state.
Range:	Top Ctr Bot
Initial S/W Revision:	A.03.00
Help Map ID:	40653

Ref Position (Rise & Fall view)

Allows you to set the display reference position to Top, Center, or Bottom.

Key Path:	AMPTD Y Scale
Mode:	LTETDD, LTE

Transmit On/Off Power Measurement
Amplitude (AMPTD) Y Scale

Remote Command:	:DISPlay:PVTime:VIEW2:WINDow[1] 2:TRACe:Y[:SCALe]:RPOSi tion TOP CENTer BOTTom :DISPlay:PVTime:VIEW2:WINDow[1] 2:TRACe:Y[:SCALe]:RPOSi tion?
Example:	DISP:PVT:VIEW:WIND:TRAC:Y:RPOS CENT DISP:PVT:VIEW:WIND:TRAC:Y:RPOS?
Preset:	TOP
State Saved:	Saved in instrument state.
Range:	Top Ctr Bot
Initial S/W Revision:	A.03.00
Help Map ID:	40709

Auto Scale(Burst View)

Allows you to toggle the Y axis Auto Scale function between On and Off.

Key Path:	AMPTD Y Scale, More
Mode:	LTETDD, LTE
Remote Command:	:DISPlay:PVTime:VIEW[1]:WINDow[1]:TRACe:Y[:SCALe]:COUPl e 0 1 OFF ON :DISPlay:PVTime:VIEW[1]:WINDow[1]:TRACe:Y[:SCALe]:COUPl e?
Example:	:DISP:PVT:VIEW:WIND:TRAC:Y:COUP ON :DISP:PVT:VIEW:WIND:TRAC:Y:COUP?
Couplings:	When Auto Scale is On, and you press the Restart front-panel key, this function automatically determines the scale per division and reference values based on the measurement results. When you manually set a value for the Y Rel Value or Y Scale/Div, this parameter is automatically set to Off.
Preset:	ON
State Saved:	Saved in instrument state.
Range:	On Off
Initial S/W Revision:	A.03.00
Help Map ID:	40654

Auto Scale (Rise & Fall view)

Allows you to toggle the Y-axis auto scaling function between On and Off.

Key Path:	AMPTD Y Scale
Mode:	LTETDD, LTE
Remote Command:	:DISPlay:PVT:ime:VIEW2:WINDow[1] 2:TRACe:Y[:SCALe]:COUPL e 0 1 OFF ON :DISPlay:PVT:ime:VIEW2:WINDow[1] 2:TRACe:Y[:SCALe]:COUPL e?
Example:	DISP:PVT:VIEW:WIND:TRAC:Y:COUP 0 DISP:PVT:VIEW:WIND:TRAC:Y:COUP?
Couplings:	When Auto Scale is On, and you press the Restart front-panel key, this function automatically determines the scale per division and reference values based on the measurement results. When you manually set a value for the Y Rel Value or Y Scale/Div, this parameter is automatically set to Off.
Preset:	ON
State Saved:	Saved in instrument state.
Range:	On Off
Initial S/W Revision:	A.03.00
Help Map ID:	40710

Auto Couple

Operation of this key is identical across several measurements. For details about this key, see [AUTO COUPLE@3041@i](#) in the "Common Measurement Functions".

Key Path:	Front-panel key
Help Map ID:	0

BW

This key allows you to set the Bandwidth of the signal being measured.

Preset To Standard	Info BW	Notes
1.4 MHz (6 RB)	1.5 MHz	
3.0 MHz (15 RB)	3.0 MHz	
5.0 MHz (25 RB)	5.0 MHz	
10.0 MHz (50 RB)	10.0 MHz	Need B25 opt
15.0 MHz (75 RB)	25.0 MHz	Need B25 opt
20.0 MHz (100 RB)	25.0 MHz	Need B25 opt

Bandwidth	Info BW	Notes
1.4 MHz (6 RB)	1.08 MHz	Need B40
3.0 MHz (15 RB)	2.7 MHz	Need B40
5.0 MHz (25 RB)	4.5 MHz	Need B40
10.0 MHz (50 RB)	9.0 MHz	Need B40
15.0 MHz (75 RB)	13.5 MHz	Need B40
20.0 MHz (100 RB)	18.0 MHz	Need B40

Key Path:	BW
Mode:	LTETDD, LTE
Remote Command:	[:SENSE] :PVTime: BANDwidth <freq> [:SENSE] :PVTime: BANDwidth?
Example:	PVT: BAND 6.0 MHz PVT: BAND?
Couplings:	This parameter is coupled with Preset to Standard in Mode Setup Menu. The relationship is in the table above.
Preset:	5.0 MHz
State Saved:	Saved in instrument state.
Min:	10 Hz

Transmit On/Off Power Measurement
BW

Max:	Hardware Dependent: No Option = 10 MHz Option B25 = 25 MHz Option B40 = 40 MHz
Initial S/W Revision:	A.03.00
Help Map ID:	40655

Cont

Operation of this key is identical across several measurements. For details about this key, see [Cont \(Continuous Measurement/Sweep\)@3309@i](#) in the "Common Measurement Functions".

Key Path:	Front-panel key
Help Map ID:	0

FREQ Channel

Operation of this key is identical across several measurements. For details about this key, see [FREQ Channel@3057](#) in the “Common Measurement Functions”.

Key Path:	Front-panel key
Help Map ID:	0

Input/Output

Operation of this key is identical across several measurements. For details about this key, see [Input/Output@3065@i](#) in the "Common Measurement Functions".

Key Path:	Front-panel key
Help Map ID:	0

Marker

Accesses the menu that allows you to select, set up, and control the markers for the current measurement. Sets the marker control mode as described under **Normal**, **Delta**, and **Off**, below. All interactions and dependencies detailed under the softkey description are enforced when the remote command is sent.

See [Marker@3149](#) in the "Common Measurement Functions" for more information.

Key Path:	Front-panel key
Initial S/W Revision:	A.03.00
Help Map ID:	40656

Select Marker

Accesses a menu that allows you to activate one or more markers

See Marker in the "Marker Functions" section for more information.

Key Path:	Marker
Initial S/W Revision:	A.03.00
Help Map ID:	40657

Marker Type

Sets the marker control mode. If the selected marker is Off, pressing Marker sets it to Normal and places it at the center of the screen on the trace determined by the **Marker Trace** rules. At the same time, the reference value of the selected marker appears on the Active Function area.

Active Function Display: Marker X-axis value

Default Active Function: the active function for the selected marker's current control mode. If the current control mode is Off, there is no active function and the active function is turned off.

The marker X axis value entered in the active function area will display the marker value to its full entered precision.

Key Path:	Marker
Mode:	LTETDD, LTE
Remote Command:	:CALCulate:PVTime:MARKer [1] 2 3 4 5 6 7 8 9 10 11 12 :MO DE POSITION DELTA OFF :CALCulate:PVTime:MARKer [1] 2 3 4 5 6 7 8 9 10 11 12 :MO DE?
Example:	:CALC:PVT:MARK:MODE OFF :CALC:PVT:MARK:MODE?

Notes:	<p>If the selected marker is Off, pressing Marker sets it to Normal and places it at the center of the screen on the trace determined by the Marker Trace rules. At the same time, Marker X Axis Value appears in the Active Function area.</p> <p>Default Active Function: the active function for the selected marker's current control mode. Note that if the current control mode is Off, there is no active function and the active function is turned off.</p> <p>Active Function Display: the marker X axis value entered in the active function area will display the marker value to its fully entered precision.</p>
Preset:	OFF
State Saved:	Saved in instrument state.
Range:	Normal Delta Off
Initial S/W Revision:	A.03.00
Help Map ID:	40658

Marker X Axis Value

Sets the marker X Axis value in the current marker X Axis Scale unit. It has no effect if the control mode is **Off**, but is the SCPI equivalent of entering an X value, if the control mode is **Normal** or **Delta**.

Key Path:	Marker, Select Marker
Mode:	LTETDD, LTE
Remote Command:	<pre>:CALCulate:PVTtime:MARKer [1] 2 3 4 5 6 7 8 9 10 11 12 :X <real></pre> <pre>:CALCulate:PVTtime:MARKer [1] 2 3 4 5 6 7 8 9 10 11 12 :X?</pre>
Example:	<pre>:CALC:PVT:MARK3:X 0</pre> <pre>:CALC:PVT:MARK3:X?</pre>
Notes:	<p>If no suffix is sent, it will use the fundamental units for the current marker X Axis Scale. If a suffix is sent that does not match the current marker X Axis Scale unit, an "Invalid suffix" error will be generated.</p> <p>The query returns the marker's absolute X Axis value if the control mode is Normal, or the offset from the marker's reference marker, if the control mode is Delta. The query is returned in the fundamental units for the current marker X Axis scale: seconds. If the marker is off the response is not a number (NAN).</p>
Couplings:	Max value would be changed by Meas Interval in 6.3.2 in epsg1129241.
Preset:	After a preset, all markers are turned OFF, so a Marker X Axis Value query will return a not a number (NAN).
State Saved:	No
Min:	-9.9E+37

Max:	9.9E+37
Initial S/W Revision:	A.03.00
Help Map ID:	40659

Marker X Axis Position (Remote Command only)

Sets the marker X position in trace points. This allows you to enter a value in trace points rather than in X Axis Scale units. The entered value is immediately converted into the current X Axis Scale unit for setting the value of the marker. It has no effect if the control mode is **Off**, but is the SCPI equivalent of entering an X value, if the control mode is **Normal** or **Delta**.

Mode:	LTETDD, LTE
Remote Command:	:CALCulate:PVTime:MARKer [1] 2 3 4 5 6 7 8 9 10 11 12 :X: POSition <real> :CALCulate:PVTime:MARKer [1] 2 3 4 5 6 7 8 9 10 11 12 :X: POSition?
Example:	:CALC:PVT:MARK10:X:POS 500 :CALC:PVT:MARK10:X:POS?
Notes:	A query returns the marker's absolute X Axis value in trace points, if the control mode is Normal , or the offset from the marker's reference marker in trace points, if the control mode is Delta . If the marker is Off the response is not a number (NAN).
Preset:	After a preset, all markers are turned Off, so a Marker X Axis Value query will return a not a number (NAN).
State Saved:	No
Min:	-9.9E+37
Max:	9.9E+37
Initial S/W Revision:	A.03.00
Help Map ID:	0

Marker Y Axis Value (Remote Command only)

Returns the marker Y Axis value in the current marker Y Axis unit.

The “result” of a marker is the value that is displayed on the second line of the Marker Result block. To properly interpret the returned value, you must also know how the analyzer's Y-Axis Unit is set, as described below.

A marker can have up to two results, only one of which is displayed or returned in a query, as follows:

- Absolute result: every marker has an absolute result. For Normal and Delta markers, the Y-axis value of the trace point the marker is currently On. The absolute result is displayed in the result block or returned as a query, unless the marker control mode is **Delta**.

- Relative result: if a marker's control mode is **Delta**, the relative result is displayed in the result block or returned in a query. This is the ratio of the Absolute Result of a delta marker to the Absolute Result of its reference marker. The ratio is expressed in dB.

Mode:	LTETDD, LTE
Remote Command:	:CALCulate:PVTtime:MARKer [1] 2 3 4 5 6 7 8 9 10 11 12 : Y?
Example:	:CALC:PVT:MARK11:Y 0 :CALC:PVT:MARK11:Y?
Notes:	The query returns the marker Y-axis result. If the marker is Off the response is not a number (NAN).
Preset:	0
State Saved:	No
Initial S/W Revision:	A.03.00
Help Map ID:	0

Properties

Accesses a menu that allows you to set marker properties and to access the marker trace menu.

Key Path:	Marker
Initial S/W Revision:	A.03.00
Help Map ID:	40660

Select Marker

Accesses menus that allows you to select one or more markers

Key Path:	Marker, Properties
Initial S/W Revision:	A.03.00
Help Map ID:	40661

Relative To

Selects the marker that the selected marker will be relative to, which is referred to as its “reference marker”.

Key Path:	Marker, Properties
Mode:	LTETDD, LTE

Transmit On/Off Power Measurement
Marker

Remote Command:	:CALCulate:PVTime:MARKer [1] 2 3 4 5 6 7 8 9 10 11 12 : REFerence <integer> :CALCulate:PVTime:MARKer [1] 2 3 4 5 6 7 8 9 10 11 12 : REFerence?
Example:	:CALC:PVT:MARK5:REF 1 :CALC:PVT:MARK5:REF?
Notes:	When queried, a single value will be returned - the specified marker number's relative marker.
Preset:	2 3 4 5 6 7 8 9 10 11 12 1
State Saved:	Saved in instrument state.
Min:	1
Max:	12
Initial S/W Revision:	A.03.00
Help Map ID:	40662

Marker Trace

Assigns the specified marker to the designated trace.

Key Path:	Marker, Properties
Mode:	LTETDD, LTE
Remote Command:	:CALCulate:PVTime:MARKer [1] 2 3 4 5 6 7 8 9 10 11 12 : TRACe RFENvelope UMASK LMASK MAXHold MINHold :CALCulate:PVTime:MARKer [1] 2 3 4 5 6 7 8 9 10 11 12 : TRACe?
Example:	:CALC:PVT:MARK:TRAC MINH :CALC:PVT:MARK:TRAC?
Preset:	RFENvelope
State Saved:	Saved in instrument state.
Range:	RF Envelope Upper Mask Lower Mask Max Hold RF Envelope Min Hold RF Envelope
Initial S/W Revision:	A.03.00
Help Map ID:	40663

Couple Marker

When this function is invoked, moving any marker causes an “equal X Axis movement” of every other marker which is active. By “equal X Axis movement” we mean that the difference between each marker's X Axis value (in the fundamental x-axis units of the trace that marker is on) is preserved, as is

the X Axis value of the marker being moved (in the same fundamental X-axis units).

NOTE This may result in markers going off screen.

Key Path:	Marker, More
Mode:	LTETDD, LTE
Remote Command:	:CALCulate:PVTtime:MARKer:COUple[:STATE] ON OFF 1 0 :CALCulate:PVTtime:MARKer:COUple[:STATE]?
Example:	CALC:PVT:MARK:COUP ON CALC:PVT:MARK:COUP?
Preset:	OFF
State Saved:	Saved in instrument state.
Range:	On Off
Initial S/W Revision:	A.03.00
Help Map ID:	40664

All Markers Off

Turns all markers Off.

Key Path:	Marker, More
Mode:	LTETDD, LTE
Remote Command:	:CALCulate:PVTtime:MARKer:AOff
Example:	:CALC:PVT:MARK:AOff
Initial S/W Revision:	A.03.00
Help Map ID:	40665

Marker State (Remote Command Only)

Sets or queries the state of a marker. Setting a marker which is Off to state On, or 1, puts it in Normal mode and places it at the center of the screen.

Mode:	LTETDD, LTE
Remote Command:	:CALCulate:PVTtime:MARKer[1] 2 3 4 5 6 7 8 9 10 11 12:ST ATe OFF ON 0 1 :CALCulate:PVTtime:MARKer[1] 2 3 4 5 6 7 8 9 10 11 12:ST ATe?

Transmit On/Off Power Measurement
Marker

Example:	:CALC:PVT:MARK3:STATE ON :CALC:PVT:MARK3:STATE?
Preset:	OFF
State Saved:	Saved in instrument state.
Range:	On Off
Initial S/W Revision:	A.03.00
Help Map ID:	0

Marker Fctn

There are no 'Marker Functions' supported in transmit On/Off Power measurement. Pressing this key will display a blank menu.

Key Path:	Front-panel key
Initial S/W Revision:	A.03.00
Help Map ID:	40666

Marker To

There is no 'Marker To' functionality supported in Transmit On/Off Power measurement so this front-panel key will display a blank menu when pressed

Key Path:	Front-panel key
Initial S/W Revision:	A.03.00
Help Map ID:	40667

Meas

Operation of this key is identical across several measurements. For details about this key, see [Meas@4008@i](#) in the "Common Measurement Functions".

Key Path:	Front-panel key
Help Map ID:	0

Meas Setup

Accesses the measurement setup menu for the current measurement.

Key Path:	Front-panel key
Initial S/W Revision:	A.03.00
Help Map ID:	40668

Avg/Hold Num

Used to specify the number of data acquisitions that will be averaged. After the specified number of average counts, the averaging mode (termination control) setting determines the averaging action.

- On - Sets measurement averaging on.
- Off - Sets measurement averaging off.

Key Path:	Meas Setup
Mode:	LTETDD, LTE
Remote Command:	[:SENSe]:PVTime:AVERage:COUNT <integer> [:SENSe]:PVTime:AVERage:COUNT? [:SENSe]:PVTime:AVERage[:STATe] OFF ON 0 1 [:SENSe]:PVTime:AVERage[:STATe]?
Example:	:SENS:PVT:AVER:COUN 10 :SENS:PVT:AVER:COUN? :SENS:PVT:AVER:STAT OFF :SENS:PVT:AVER:STAT?
Preset:	10 OFF
State Saved:	Saved in instrument state.
Min:	1
Max:	10000
Initial S/W Revision:	A.03.00
Help Map ID:	40669

Avg Mode

Selects the type of termination control used for the averaging function. This determines the averaging

action after the specified number of data acquisitions (average count) is reached.

KEY:Exponential SCPI:EXponential	After the average count is reached, each successive data acquisition is exponentially weighted and combined with the existing average.
KEY:Repeat SCPI:REPeat	After reaching the average count, the averaging is reset and a new average is started. The default value is Exp.

Key Path:	Meas Setup
Mode:	LTETDD, LTE
Remote Command:	[:SENSE] :PVTtime:AVERage:TCONtrol EXPonential REPeat [:SENSe] :PVTtime:AVERage:TCONtrol?
Example:	:SENS:PVT:AVER:TCON REP :SENS:PVT:AVER:TCON?
Preset:	REPeat
State Saved:	Saved in instrument state.
Range:	Exp Repeat
Initial S/W Revision:	A.03.00
Help Map ID:	40670

Avg Type

Specifies the type of trace and result averaging to use.

KEY:Pwr Avg (RMS) SCPI:RMS POWER	True power averaging that is equivalent to taking the RMS value of the voltage. It is the most accurate type of averaging.
KEY:Log-Pwr Avg (Video) SCPI:LOG LPOWER	Simulates the traditional spectrum analyzer type of averaging by averaging the log of the power.

Key Path:	Meas Setup
Mode:	LTETDD, LTE
Remote Command:	[:SENSe] :PVTtime:AVERage:TYPE LOG LPOWER RMS POWER [:SENSe] :PVTtime:AVERage:TYPE?
Example:	:SENS:PVT:AVER:TYPE RMS :SENS:PVT:AVER:TYPE?
Preset:	RMS

Transmit On/Off Power Measurement
Meas Setup

State Saved:	Saved in instrument state.
Range:	Pwr Avg (RMS) Log-Pwr Avg(Video)
Initial S/W Revision:	A.03.00
Help Map ID:	40671

Ramp Time Length

This parameter indicates the searching window length from which the ramp on and down is searched. If it is set shorter than actual ramp time, the ramp may be lost.

Key Path:	Meas Setup
Mode:	LTETDD, LTE
Remote Command:	[:SENSE] :PVTime :RAMP :SEARCh :LENGth <time> [:SENSE] :PVTime :RAMP :SEARCh :LENGth?
Example:	PVT:RAMP:SEAR:LENG 1.0 PVT:RAMP:SEAR:LENG?
Preset:	17.0 us
State Saved:	Saved in instrument state.
Min:	1.0 us
Max:	100.0 us
Initial S/W Revision:	A.07.00
Help Map ID:	40724

IF Gain

Accesses the menu that sets ranging in the digital IF when acquiring an I/Q time record.

See [“More Information about IF Gain” on page 708](#).

NOTE This function is not affected by RF Input Range attenuation.

Key Path:	Meas Setup
Initial S/W Revision:	A.03.00
Help Map ID:	40672

More Information about IF Gain

To take full advantage of the RF dynamic range of the analyzer, you can manually turn on or turn off a switched digital IF amplifier. When it is turned on, the signal will get approximately 10 dB of gain.

- Setting IF Gain to Man and selecting High Gain will turn on the digital IF amplifier and get an extra 10 dB gain.
- Setting IF Gain to Auto will activate the Auto rules for IF Gain.

These settings affect sensitivity and IF overloads.

IF Gain Auto

Activates the Auto Rules for IF Gain. When Auto is active, the IF Gain is set to High Gain under any of the following conditions:

- the input attenuator is set to 0 dB
- the preamp is turned On
- the Max Mixer Level is 20 dBm or lower

For other settings, Auto sets IF Gain to Off.

Key Path:	Meas Setup,IF Gain
Mode:	LTETDD, LTE
Remote Command:	[:SENSe] :PVTime: IF:GAIN:AUTO [:STATe] ON OFF 1 0 [:SENSe] :PVTime: IF:GAIN:AUTO [:STATe] ?
Example:	PVT:IF:GAIN:AUTO ON PVT:IF:GAIN:AUTO?
Couplings:	When either the auto attenuation is active (for example, with an electrical attenuator), or the optimize mechanical attenuator range is requested, the IF Gain setting is changed using the following rule. The Auto selection sets IF Gain On under any of the following conditions: <ul style="list-style-type: none"> • the input attenuator is set to 0 dB • the preamp is turned on, • the Max Mixer Level is 20 dBm or lower. For other settings, Auto sets IF Gain to Off.
Preset:	OFF
State Saved:	Saved in instrument state.
Range:	Auto Man
Initial S/W Revision:	A.03.00
Help Map ID:	40673

IF Gain State

Selects the range of IF gain.

- On sets the high gain option, which allows for better noise level measurements.

Transmit On/Off Power Measurement
Meas Setup

- Off sets low gain when measuring large signals.

When this parameter is changed manually from front panel, IF Gain Auto will become Man.

Key Path:	Meas Setup, IF Gain
Mode:	LTETDD, LTE
Remote Command:	[:SENSE] :PVTime:IF:GAIN[:STATe] ON OFF 1 0 [:SENSe] :PVTime:IF:GAIN[:STATe] ?
Example:	PVT:IF:GAIN ON PVT:IF:GAIN?
Notes:	where ON = high gain OFF = low gain
Preset:	OFF
State Saved:	Saved in instrument state.
Range:	Low Gain (Best for Large Signals) High Gain (Best Noise Level)
Readback Text:	Low Gain High Gain
Initial S/W Revision:	A.03.00
Help Map ID:	40674

Limits

Accesses the setup menu for the measurement ramp up, ramp down time and threshold for off power.

Please note, whether the pass/fail shown in measurement bar(at upper-left corner of screen) will be pass or fail is just determined by the threshold listed in Limits menu, they are Max Ramp Up Time, Max Ramp Down Time, Downlink Off Power and Uplink Off Power. If and only if ramp up time, ramp down time and off power (downlink or uplink) measured are all less than Max Ramp Up Time, Max Ramp Down Time and Off Power

(downlink or uplink) separately, the Pass/Fail flag is set to pass(green), otherwise Pass/Fail flag is set to fail(red). The limit mask shown on screen is just to indicate which part is active burst and which part is inactive burst, the mask is nothing to do with the Pass/Fail criteria.

Key Path:	Meas Setup
Initial S/W Revision:	A.03.00
Help Map ID:	40706

Max Ramp Up Time

It used as threshold which can judge whether the real measured ramp up time can be passed or not. If real measured ramp up time exceeds Max Ramp Up Time, then ramp up time measurement fails, otherwise, it

passes.

Key Path:	Meas Setup, More, Limits
Mode:	LTETDD, LTE
Remote Command:	[:SENSe] :PVTime:LIMit:RAMP:URTime <time> [:SENSe] :PVTime:LIMit:RAMP:URTime?
Example:	PVT:LIM:RAMP:URT 17.0e-6 PVT:LIM:RAMP:URT?
Couplings:	While Downlink is selected, the default value is 17us, and while Uplink is selected, the default value is 20.0us.
Preset:	17.0 us
State Saved:	No
Min:	1.0 us
Max:	100.0 us
Initial S/W Revision:	A.03.00
Help Map ID:	40675

Max Ramp Down Time

It used as threshold which can judge whether the real measured ramp down time can be passed or not. If real measured ramp down time exceeds Max Ramp Down Time, then ramp down time measurement fails, otherwise, it passes.

Key Path:	Meas Setup, More, Limits
Mode:	LTETDD, LTE
Remote Command:	[:SENSe] :PVTime:LIMit:RAMP:DRTIME <time> [:SENSe] :PVTime:LIMit:RAMP:DRTIME? [:SENSe] :PVTime:LIMit:RAMP:DRTIME?
Example:	PVT:LIM:RAMP:DRT 17.0e-6 PVT:LIM:RAMP:DRT?
Couplings:	While Downlink is selected, the default value is 17us, and while Uplink is selected, the default value is 20.0us.
Preset:	17.0 us
State Saved:	No
Min:	1.0 us
Max:	100.0 us
Initial S/W Revision:	A.03.00

Transmit On/Off Power Measurement
Meas Setup

Help Map ID:	40676
--------------	-------

Downlink Off Power

It is used as threshold in downlink which can judge whether the real measured off power can be passed or not. If real measured off power exceeds Downlink Off Power, then off power measurement fails, otherwise, it passes. Please note, the unit of this parameter is dBm/MHz.

Key Path:	Meas Setup, More, Limits
Mode:	LTETDD, LTE
Remote Command:	[:SENSE] :PVTime:LIMit:POFF:DLINk <real> [:SENSE] :PVTime:LIMit:POFF:DLINk? [:SENSE] :PVTime:LIMit:POFF:DLINk?
Example:	PVT:LIM:POFF:DLIN -89.0 PVT:LIM:POFF:DLIN?
Preset:	-85.00
State Saved:	Saved in instrument state.
Min:	-150.00
Max:	0.00
Initial S/W Revision:	A.04.00
Help Map ID:	40704

Uplink Off Power

It is used as threshold in uplink which can judge whether the real measured off power can be passed or not. If real measured off power exceeds Uplink Off Power, then off power measurement fails, otherwise, it passes. Please note, the unit of this parameter is dBm.

Key Path:	Meas Setup, More, Limits
Mode:	LTETDD, LTE
Remote Command:	[:SENSE] :PVTime:LIMit:POFF:ULINk <real> [:SENSE] :PVTime:LIMit:POFF:ULINk? [:SENSE] :PVTime:LIMit:POFF:ULINk?
Example:	PVT:LIM:POFF:ULIN -50.0 PVT:LIM:POFF:ULIN:DRT?
Preset:	-50.00
State Saved:	Saved in instrument state.
Min:	-150.00 dBm
Max:	0.00 dBm

Initial S/W Revision:	A.04.00
Help Map ID:	40705

Threshold

Accesses the setup menu to set the thresholds used to find ramp up and ramp down part in burst signal.

Key Path:	Meas Setup
Initial S/W Revision:	A.03.00
Help Map ID:	40711

Ramp Up Start Level

It specifies the relative power level to active slots average power level at which the ramp-up starts.

Key Path:	Meas Setup, More, Threshold
Mode:	LTETDD, LTE
Remote Command:	[:SENSE] :PVTtime:THReshold:UP:START <rel_ampl> [:SENSE] :PVTtime:THReshold:UP:START?
Example:	PVT:THR:UP:STAR -50.0 PVT:THR:UP:STAR?
Preset:	-20.000 dB
State Saved:	Saved in instrument state.
Min:	-120.000 dB
Max:	0.000 dB
Initial S/W Revision:	A.03.00
Help Map ID:	40712

Ramp Up End Level

It specifies the relative power level to active slots average power level at which the ramp-up ends.

Key Path:	Meas Setup, More, Threshold
Mode:	LTETDD, LTE
Remote Command:	[:SENSE] :PVTtime:THReshold:UP:END <rel_ampl> [:SENSE] :PVTtime:THReshold:UP:END?
Example:	PVT:THR:UP:END -50.0 PVT:THR:UP:END?

Transmit On/Off Power Measurement
Meas Setup

Preset:	-0.915 dB
State Saved:	Saved in instrument state.
Min:	-120.000 dB
Max:	0.000 dB
Initial S/W Revision:	A.03.00
Help Map ID:	40713

Ramp Down Start Level

It specifies the relative power level to active slots average power level at which the ramp-down starts.

Key Path:	Meas Setup, More, Threshold
Mode:	LTETDD, LTE
Remote Command:	[:SENSE] :PVTime:THreshold:DOWN:START <rel_ampl> [:SENSE] :PVTime:THreshold:DOWN:START?
Example:	PVT:THR:DOWN:STAR -50.0 PVT:THR:DOWN:STAR?
Preset:	-0.915 dB
State Saved:	Saved in instrument state.
Min:	-120.000 dB
Max:	0.000 dB
Initial S/W Revision:	A.03.00
Help Map ID:	40714

Ramp Down End Level

It specifies the relative power level to active slots average power level at which the ramp-down ends.

Key Path:	Meas Setup, More, Threshold
Mode:	LTETDD, LTE
Remote Command:	[:SENSE] :PVTime:THreshold:DOWN:END <rel_ampl> [:SENSE] :PVTime:THreshold:DOWN:END?
Example:	PVT:THR:DOWN:END -50.0 PVT:THR:DOWN:END?
Preset:	-20.000 dB
State Saved:	Saved in instrument state.

Min:	-120.000 dB
Max:	0.000 dB
Initial S/W Revision:	A.03.00
Help Map ID:	40715

Noise Correction

Sets the noise floor correction function to On or Off. On enables measurement noise correction when the measured power in the reference channel or any offset is close to the noise floor of the analyzer. Off turns these corrections off.

Key Path:	Meas Setup
Remote Command:	[:SENSe] :PVTime :CORRection :NOISe [:AUTO] OFF ON 0 1 [:SENSe] :PVTime :CORRection :NOISe [:AUTO] ?
Example:	PVT:CORR:NOIS OFF PVT:CORR:NOIS?
Preset:	0
State Saved:	Saved in instrument state.
Range:	On Off
Initial S/W Revision:	A.03.00
Help Map ID:	40716

Meas Preset

Returns parameters for the current measurement to those set by the factory.

Key Path:	Meas Setup, More
Mode:	LTETDD, LTE
Remote Command:	:CONFigure:PVTime
Example:	:CONF:PVT
Initial S/W Revision:	A.03.00
Help Map ID:	40677

Predefined Parameters

Key Path:	Meas Setup
-----------	-------------------

Transmit On/Off Power Measurement
Meas Setup

Mode:	LTE
Help Map ID:	40726

Analysis Slot

This parameter specifies the starting analysis slot.

Key Path:	Meas Setup, Pre-defined Parameters
Mode:	LTE
Remote Command:	[:SENSE] :PVTime :SLOT TS0 TS1 TS2 TS3 TS4 TS5 TS6 TS7 TS8 TS9 TS10 TS11 TS12 TS13 TS14 TS15 TS16 TS17 TS18 TS19 [:SENSE] :PVTime :SLOT?
Example:	PVT:SLOT TS0
Preset:	TS0
State Saved:	Saved in instrument state.
Range:	TS0 TS1 TS2 TS3 TS4 TS5 TS6 TS7 TS8 TS9 TS10 TS11 TS12 TS13 TS14 T S15 TS16 TS17 TS18 TS19
Initial S/W Revision:	A.11.00
Help Map ID:	40727

Meas Interval

This parameter specifies the desired slots count that needs to be analyzed. The measurement will adjust meas interval according to this parameter.

Key Path:	Meas Setup, Pre-defined Parameters
Mode:	LTE
Remote Command:	[:SENSE] :PVTime :MINTerval <integer> [:SENSE] :PVTime :MINTerval
Example:	:PVT:MINT 1
Couplings:	When Measure PRACH/SRS is not OFF, this key is disabled.
Preset:	1
State Saved:	Saved in instrument state.
Min:	1
Max:	20
Initial S/W Revision:	A.11.00
Help Map ID:	40728

CP Length

The Mode of CP Length will affect the length of one OFDM symbol, it will be useful when SRS is under test, since usually the length of SRS is 1 symbol.

Key Path:	Meas Setup, Pre-defined Parameters
Mode:	LTE
Remote Command:	[:SENSE] :PVTime:CPLength NORMAl EXTended [:SENSE] :PVTime:CPLength?
Example:	PVT:CPL NORM
Preset:	NORMAl
State Saved:	Saved in instrument state.
Range:	Normal Extended
Initial S/W Revision:	A.11.00
Help Map ID:	40729

Measure PRACH/SRS

This key specifies whether the signal under test is PRACH channel or SRS, and the PRACH preamble format of the analysis slot.

The algorithm will perform OFF power measuring according to the specified signal type.

Key Path:	Meas Setup, Pre-defined Parameters
Mode:	LTE
Remote Command:	[:SENSE] :PVTime:MEASure OFF PPF0 PPF1 PPF2 PPF3 SRS [:SENSE] :PVTime:MEASure?
Example:	PVT:MEAS OFF
Couplings:	If direction is downlink, the key is disabled.
Preset:	OFF
State Saved:	Saved in instrument state.
Range:	Off Preamble 0 Preamble 1 Preamble 2 Preamble 3 SRS
Initial S/W Revision:	A.11.00
Help Map ID:	40730

Mode

See [Key and Command descriptions@2670@i](mailto:Key_and_Command_descriptions@2670@i) for more information.

Key Path:	Front-panel key
Help Map ID:	0

Mode Setup

See [Mode Setup@\(LTE\)28881,\(LTETDD\)4001](#) for more information.

Key Path:	Front-panel key
Help Map ID:	0

Peak Search

There is no Peak Search functionality supported in Transmit On/Off Power measurement

Key Path:	Front-panel key
Initial S/W Revision:	A.03.00
Help Map ID:	40678

Recall

Operation of this key is identical across several measurements. For details about this key, see [Recall@\(LTE\)28892, \(LTETDD\)40472](#) in the "Common Measurement Functions".

Key Path:	Front-panel key
Help Map ID:	0

Restart

Operation of this key is identical across several measurements. For details about this key, see [Restart@3307@i](#) in the "Common Measurement Functions".

Key Path:	Front-panel key
Help Map ID:	0

Save

Operation of this key is identical across several measurements. For details about this key, see [Save@2600@i](#) in the "Common Measurement Functions".

Key Path:	Front-panel key
Help Map ID:	0

Single

Operation of this key is identical across several measurements. For details about this key, see [Single \(Single Measurement/Sweep\)@3515@i](#) in the "Common Measurement Functions".

Key Path:	Front-panel key
Help Map ID:	0

Source (Internal)

See Source@35360@i for more information.

Key Path	Front-panel key
Initial S/W Revision	Prior to A.02.00
Help Map ID	0

SPAN X Scale

Accesses a menu of functions that enable you set the horizontal scale parameters.

Key Path:	Front-panel key
Initial S/W Revision:	A.03.00
Help Map ID:	40680

Ref Value(Burst View)

Allows you to set the display X reference value.

Key Path:	SPAN X Scale
Mode:	LTETDD, LTE
Remote Command:	:DISPlay:PVTime:VIEW[1]:WINDow[1]:TRACe:X[:SCALE]:RLEVe l <time> :DISPlay:PVTime:VIEW[1]:WINDow[1]:TRACe:X[:SCALE]:RLEVe l?
Example:	DISP:PVT:VIEW:WIND:TRACE:X:RLEV 1s DISP:PVT:VIEW:WIND:TRACE:X:RLEV?
Notes:	If X Auto Scale is On, this value is automatically determined by the measurement result. When a value is set manually, X Auto Scale is automatically set to Off.
Couplings:	See Notes
Preset:	0 s
State Saved:	Saved in instrument state.
Min:	-10.0 s
Max:	10.00 s
Initial S/W Revision:	A.03.00
Help Map ID:	40681

Ref Value(Rise & Fall view)

Allows you to set the display X reference value.

Key Path:	SPAN X Scale
Mode:	LTETDD, LTE

Remote Command:	:DISPlay:PVTtime:VIEW2:WINDow[1] 2:TRACe:X[:SCALe]:RLEVe l <time> :DISPlay:PVTtime:VIEW2:WINDow[1] 2:TRACe:X[:SCALe]:RLEVe l?
Example:	DISP:PVT:VIEW2:WIND2:TRAC:X:RLEV 1 DISP:PVT:VIEW2:WIND2:TRAC:X:RLEV?
Notes:	If X Auto Scale is On, this value is automatically determined by the measurement result. When a value is set manually, X Auto Scale is automatically set to Off.
Couplings:	See Notes
Preset:	0 s
State Saved:	Saved in instrument state.
Min:	-10.0 s
Max:	10.00 s
Initial S/W Revision:	A.03.00
Help Map ID:	40717

Scale/Div(Burst View)

Allows you to set the display X scale/division value.

Key Path:	SPAN X Scale
Mode:	LTETDD, LTE
Remote Command:	:DISPlay:PVTtime:VIEW[1]:WINDow[1]:TRACe:X[:SCALe]:PDIVi sion <time> :DISPlay:PVTtime:VIEW[1]:WINDow[1]:TRACe:X[:SCALe]:PDIVi sion?
Example:	:DISP:PVT:VIEW:WIND:TRACE:X:PDIV 1ms :DISP:PVT:VIEW:WIND:TRACE:X:PDIV?
Notes:	If X Auto Scale is set to On, this value is automatically determined by the measurement result. When a value is set manually, X Auto Scale is automatically set to Off.
Couplings:	See Notes
Preset:	1.0 ms
State Saved:	Saved in instrument state.
Min:	1.00 ns
Max:	1.00 s

Transmit On/Off Power Measurement
SPAN X Scale

Initial S/W Revision:	A.03.00
MIN/MAX/DEF Support:	Yes
Help Map ID:	40682

Scale/Div(Rise & Fall View)

Allows you to set the display X scale/division value.

Key Path:	SPAN X Scale
Mode:	LTETDD, LTE
Remote Command:	:DISPlay:PVTime:VIEW2:WINDow[1] 2:TRACe:X[:SCALE] :PDIVi sion <time> :DISPlay:PVTime:VIEW2:WINDow[1] 2:TRACe:X[:SCALE] :PDIVi sion?
Example:	DISP:PVT:VIEW2:WIND2:TRAC:X:PDIV 1ms DISP:PVT:VIEW2:WIND2:TRAC:X:PDIV?
Notes:	If X Auto Scale is set to On, this value is automatically determined by the measurement result. When a value is set manually, X Auto Scale is automatically set to Off.
Couplings:	See Notes
Preset:	4.0 us
State Saved:	Saved in instrument state.
Min:	1.00 ns
Max:	1.00 s
Initial S/W Revision:	A.03.00
MIN/MAX/DEF Support:	Yes
Help Map ID:	40718

Ref Position(Burst View)

Allows you to set the X reference position to the left, center, or right of the display.

Key Path:	SPAN X Scale
Mode:	LTETDD, LTE
Remote Command:	:DISPlay:PVTime:VIEW[1] :WINDow[1] :TRACe:X[:SCALE] :RPOSi tion LEFT CENTer RIGHT :DISPlay:PVTime:VIEW[1] :WINDow[1] :TRACe:X[:SCALE] :RPOSi tion?

Example:	:DISP:PVT:VIEW:WIND:TRACE:X:RPOS LEFT :DISP:PVT:VIEW:WIND:TRACE:X:RPOS?
Preset:	LEFT
State Saved:	Saved in instrument state.
Range:	Left Ctr Right
Initial S/W Revision:	A.03.00
Help Map ID:	40683

Ref Position(Rise & Fall View)

Allows you to set the X reference position to the left, center, or right of the display.

Key Path:	SPAN X Scale
Mode:	LTETDD, LTE
Remote Command:	:DISPlay:PVT:ime:VIEW2:WINDow[1] 2:TRACe:X[:SCALe]:RPOSi tion LEFT CENTer RIGHT :DISPlay:PVT:ime:VIEW2:WINDow[1] 2:TRACe:X[:SCALe]:RPOSi tion?
Example:	DISP:PVT:VIEW2:WIND2:TRAC:X:RPOS LEFT DISP:PVT:VIEW2:WIND2:TRAC:X:RPOS?
Preset:	CENTer
State Saved:	Saved in instrument state.
Range:	Left Ctr Right
Initial S/W Revision:	A.03.00
Help Map ID:	40719

Auto Scale(Burst View)

Allows you to toggle the X Auto Scale function between On and Off.

Key Path:	SPAN X Scale
Mode:	LTETDD, LTE
Remote Command:	:DISPlay:PVT:ime:VIEW[1]:WINDow[1]:TRACe:X[:SCALe]:COUPl e 0 1 OFF ON :DISPlay:PVT:ime:VIEW[1]:WINDow[1]:TRACe:X[:SCALe]:COUPl e?

Transmit On/Off Power Measurement
SPAN X Scale

Example:	:DISP:PVT:VIEW:WIND:TRAC:X:COUP OFF :DISP:PVT:VIEW:WIND:TRAC:X:COUP?
Notes:	Upon pressing the Restart front-panel key, the scale coupling function automatically determines the scale per division and reference values, based on the measurement results, if this parameter is set to On. When you manually set a value to either X Rel Value or X Scale/Div, X Auto Scale is automatically set to Off.
Couplings:	See Notes
Preset:	ON
State Saved:	Saved in instrument state.
Range:	On Off
Initial S/W Revision:	A.03.00
Help Map ID:	40684

Auto Scale(Rise & Fall View)

Allows you to toggle the X Auto Scale function between On and Off.

Key Path:	SPAN X Scale
Mode:	LTETDD, LTE
Remote Command:	:DISP:play:PVT:ime:VIEW2:WINDow[1] 2:TRACe:X[:SCALE] :COUPl e 0 1 OFF ON :DISP:play:PVT:ime:VIEW2:WINDow[1] 2:TRACe:X[:SCALE] :COUPl e?
Example:	DISP:PVT:VIEW2:WIND2:TRAC:X:COUP OFF DISP:PVT:VIEW2:WIND2:TRAC:X:COUP?
Notes:	Upon pressing the Restart front-panel key, the scale coupling function automatically determines the scale per division and reference values, based on the measurement results, if this parameter is set to On. When you manually set a value to either X Rel Value or X Scale/Div, X Auto Scale is automatically set to Off.
Couplings:	See Notes
Preset:	ON
State Saved:	Saved in instrument state.
Range:	On Off
Initial S/W Revision:	A.03.00
Help Map ID:	40720

Sweep/Control

Operation of this key is identical across several measurements. For details about this key, see [Sweep/Control@3273](#) in the "Common Measurement Functions".

NOTE Gate function is not supported in Transmit On/Off Power measurement.

Key Path:	Sweep/Control
Mode:	LTETDD, LTE
Help Map ID:	40685

Abort (Remote Command Only)

See [Abort \(Remote Command Only\)@3310@i](#) for more information.

Pause and Resume

See [Pause/Resume@3290@i](#) for more information.

Trace/Detector

Accesses a menu that allows you to control trace settings.

NOTE Max/Min Hold Traces will be held during the averaging cycle.

Key Path:	Front-panel key
Initial S/W Revision:	A.03.00
Help Map ID:	40686

Max Hold Trace

This key allows you to make the Max Hold Trace visible or invisible in the display..

Key Path:	Trace/Detector
Mode:	LTETDD, LTE
Remote Command:	:DISPlay:PVTime:VIEW[1]:WINDow[1]:TRACe:MAXHold[:STATe] ON OFF 1 0 :DISPlay:PVTime:VIEW[1]:WINDow[1]:TRACe:MAXHold[:STATe] ?
Example:	:DISP:PVT:VIEW:WIND:TRAC:MAXH ON :DISP:PVT:VIEW:WIND:TRAC:MAXH?
Couplings:	While Rise & Fall view is selected, this key will be grayed out. Rise & Fall view will not support trace max/min hold.
Preset:	OFF
State Saved:	Saved in instrument state.
Range:	On Off
Initial S/W Revision:	A.03.00
Help Map ID:	40687

Min Hold Trace

This key allows you to make the Min Hold Trace visible or invisible in the display.

Key Path:	Trace/Detector
Mode:	LTETDD, LTE

Remote Command:	:DISP:PVTime:VIEW[1]:WINDow[1]:TRACe:MINHold[:STATe] ON OFF 1 0 :DISP:PVTime:VIEW[1]:WINDow[1]:TRACe:MINHold[:STATe] ?
Example:	:DISP:PVT:VIEW:WIND:TRAC:MINH ON :DISP:PVT:VIEW:WIND:TRAC:MINH?
Couplings:	While Rise & Fall view is selected, this key will be grayed out. Rise & Fall view will not support trace max/min hold.
Preset:	OFF
State Saved:	Saved in instrument state.
Range:	On Off
Initial S/W Revision:	A.03.00
Help Map ID:	40688

Trigger

Selects the trigger source and trigger setup functionality.

Key Path:	Front-panel key
Initial S/W Revision:	A.03.00
Help Map ID:	40689

Trigger Source

Selects a trigger source.

NOTE Trigger Source setup parameters are valid for the current measurement.

Key Path:	Trigger
Mode:	LTETDD, LTE
Remote Command:	:TRIGger:PVTime[:SEQuence]:SOURce IMMediate VIDeo EXTernal[1] EXTernal2 RFBurst :TRIGger:PVTime[:SEQuence]:SOURce?
Example:	:TRIG:PVT:SOUR RFB :TRIG:PVT:SOUR?
Couplings:	When Direction in Mode Setup is set to Downlink, the trigger source will become External1, and when Direction is set to Uplink, the trigger source will become Periodic Timer(Frame Trigger)[Sync:RF Burst].
Preset:	External1
State Saved:	Saved in instrument state.
Range:	Free Run Video External 1 External 2 RF Burst
Initial S/W Revision:	A.03.00
Help Map ID:	40690

Auto Trig

See [Auto Trig@3436@i](#) for more information.

Trig Holdoff

See [Trig Holdoff@3437@i](#) for more information.

View/Display

Opens the View menu for the current measurement. The available views are specific to the current measurement selected under the Meas key.

All Soft Keys in the “View/Display” menu work regardless of which result window currently has the focus.

For example, the scroll function works on the lower numeric result window even if the upper RF Envelope window currently has the focus.

The **View/Display** menu includes two View Selection keys as shown below, which allow you to select the desired view of the measurement.

View	Name	Description
1	Burst (SCPI: ALL)	View Burst envelope, the length of burst can be determined by slot number in mode setup.
2	Rise & Fall (SCPI: BOTH)	Zooms in on the rising and falling portions of the burst being tested.

View Selection by name

Key Path:	View/Display
Mode:	LTETDD, LTE
Remote Command:	:DISPlay:PVTtime:VIEW[:SElect] ALL BOTH :DISPlay:PVTtime:VIEW[:SElect]?
Example:	DISP:PVT:VIEW:SEL ALL DISP:PVT:VIEW:SEL?
Preset:	ALL
State Saved:	Saved in instrument state.
Range:	Burst Rise & Fall
Initial S/W Revision:	A.03.00
Help Map ID:	40725

Mode:	LTETDD, LTE
Remote Command:	:DISPlay:PVTtime:VIEW:NSElect <integer> :DISPlay:PVTtime:VIEW:NSElect?
Example:	DISP:PVT:VIEW:NSEL 2 DISP:PVT:VIEW:NSEL?

Transmit On/Off Power Measurement View/Display

Notes:	1: Burst 2: Rise & Fall You must be in the LTETDD or LTE mode to use this command. Use INSTRument:SElect to set the mode.
Preset:	1
State Saved:	Saved in instrument state.
Min:	1
Max:	2
Initial S/W Revision:	A.03.00
Help Map ID:	0

Display

Invokes the Display menu. All measurements have the same Display menu and the same functionality for each key under the Display menu. Refer to [Display@3440](#) in the "Common Measurement Functions" for more information.

Burst View

This view shows power vs. time and mask result for a LTE-modulated burst. The view has two windows:

- “RF Envelope window” on page 737 (upper)
- “Result Metrics window” on page 737 (lower)

For the associated Remote Commands, see the subtopics under “View/Display” on page 735.

The figure below shows an example of the Burst View.

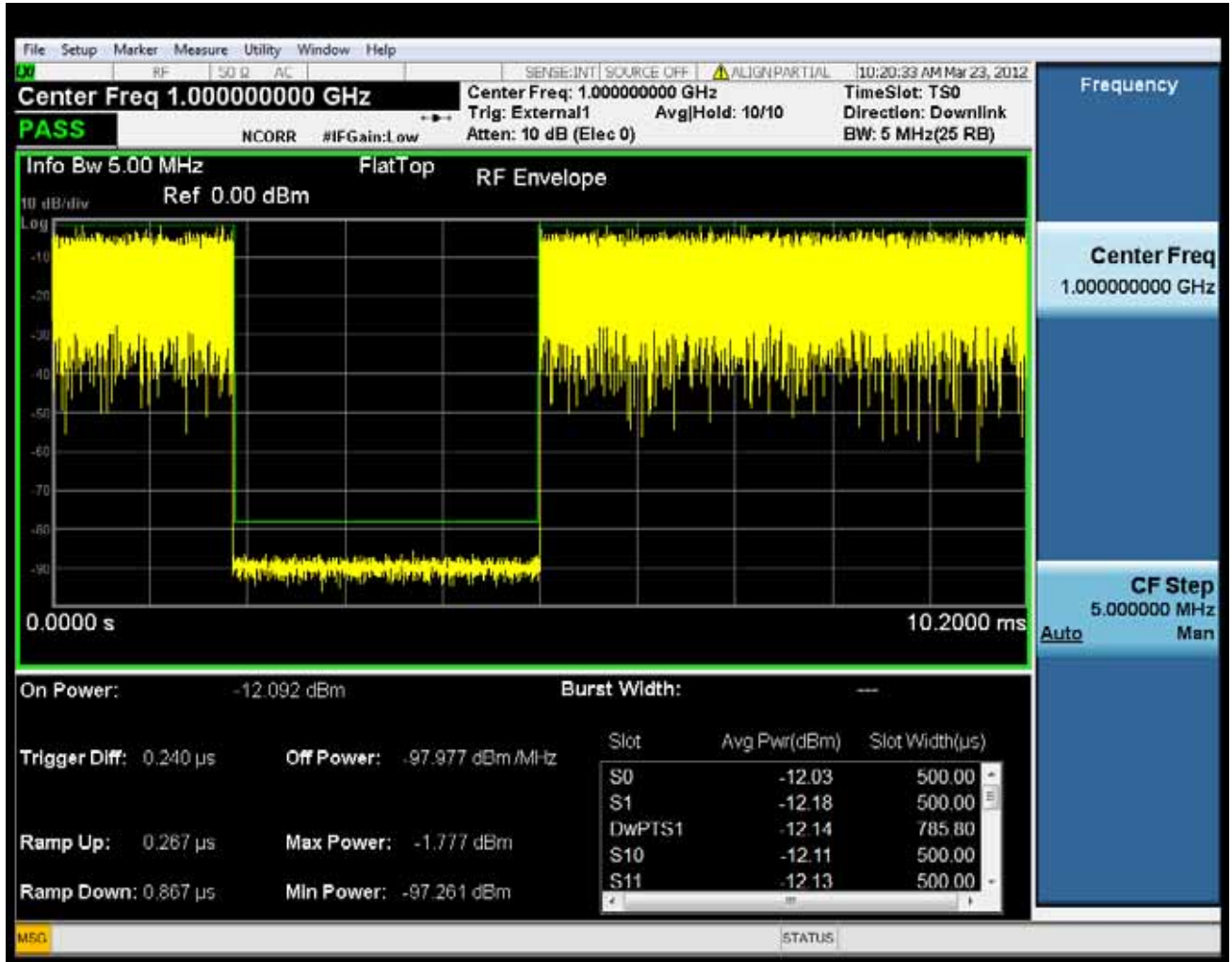

RF Envelope window

This table illustrates the details of RF envelope window:

Marker Operation	Yes
Corresponding Trace	Yellow: Signal wave form, n=2, 3, 4 White: Trigger line Red: Burst lines Blue: Ramp up/down lines

Result Metrics window

This table illustrates the details of metrics window when Direction is Downlink:

Transmit On/Off Power Measurement
View/Display

On Power:	-12.092 dBm	Burst Width:	---
Trigger Diff:	0.240 μ s	Off Power:	-97.977 dBm /MHz
Ramp Up:	0.267 μ s	Max Power:	-1.777 dBm
Ramp Down:	0.867 μ s	Min Power:	-97.261 dBm

Slot	Avg Pwr(dBm)	Slot Width(μ s)
S0	-12.03	500.00
S1	-12.18	500.00
DwPTS1	-12.14	785.80
S10	-12.11	500.00
S11	-12.13	500.00

Name	Corresponding Results	Display Format
On Power	n=1 3 rd	99.999 dBm
Burst Width	n=1 4 th	99.999 ms
Trigger Diff	n=1 5 th	99.999 us
Ramp Up	n=1 6 th	99.999 us
Ramp Down	n=1 7 th	99.999 us
Off Power	n=1 8 th	99.999 dBm
Max Power	n=1 9 th	99.999 dBm
Min Power	n=1 10 th	99.999 dBm
Slot	N/A	AAA
Avg Pwr	n=7	99.99 dBm
Slot width	n=8	99.99 us

NOTE Slot/AvgPwr/SlotWidth section only displays measure results for active slot within display range.

This table illustrates the details of metrics window when Direction is Uplink and Meas DualSRS is not selected

On Power:	-10.962 dBm	Burst Width:	0.071 ms
Trigger Diff:	---	Off Power Before:	-90.046 dBm
		Off Power After:	-90.124 dBm
Ramp Up:	0.200 μ s	Max Power:	-7.197 dBm
Ramp Down:	0.133 μ s	Min Power:	-140.573 dBm

Subframe	Avg Pwr(dBm)	Burst Width(μ s)
---	---	---

Name	Corresponding Results	Display Format
On Power	n=1 3 rd	99.999 dBm
Burst Width	n=1 4 th	99.999 ms
Trigger Diff	n=1 5 th	99.999 us
Ramp Up	n=1 6 th	99.999 us
Ramp Down	n=1 7 th	99.999 us
Off Power Before	n=1 8 th	99.999 dBm
Off Power After	n=1 13 th	99.999 dBm
Max Power	n=1 9 th	99.999 dBm
Min Power	n=1 10 th	99.999 dBm
Subframe	N/A	AAA
Avg Pwr	n=7	99.99 dBm
Burst width	n=8	99.99 us

NOTE Subframe/AvgPwr/SlotWidth section displays measure results for all subframes within display range.

When Direction is Uplink and Meas DualSRS is selected, the mean power for SRS1 and SRS2 are listed separately:

Transmit On/Off Power Measurement
View/Display

Mean Power(SRS1):	-11.117 dBm	Burst Width:	0.167 ms
Mean Power(SRS2):	-11.109 dBm		
Trigger Diff:	0.078 μ s	Off Power Before:	-87.359 dBm
		Off Power After:	-87.268 dBm
Ramp Up:	0.156 μ s	Max Power:	-7.154 dBm
Ramp Down:	0.133 μ s	Min Power:	-136.037 dBm
		Subframe	Avg Pwr(dBm)
			Burst Width(μ s)

Name	Corresponding Results	Display Format
Mean Power for SRS1	n=1 3 rd	99.999 dBm
Mean Power for SRS2	n=114 th	99.999 dBm
Burst Width	n=1 4 th	99.999 ms
Trigger Diff	n=1 5 th	99.999 us
Ramp Up	n=1 6 th	99.999 us
Ramp Down	n=1 7 th	99.999 us
Off Power Before	n=1 8 th	99.999 dBm
Off Power After	n=1 13 th	99.999 dBm
Max Power	n=1 9 th	99.999 dBm
Min Power	n=1 10 th	99.999 dBm
Subframe	N/A	AAA
Avg Pwr	n=7	99.99 dBm
Burst width	n=8	99.99 us

NOTE Subframe/AvgPwr/SlotWidth section displays measure results for all subframes within display range.

Key Path:	Front-panel key
Initial S/W Revision:	A.03.00
Help Map ID:	40721

Trigger Lines

Turns the trigger lines On or Off. Please note, Trigger Lines are just supported in RF Envelop window of

Burst view.

Key Path:	View/Display,Burst
Mode:	LTETDD, LTE
Remote Command:	:DISPlay:PVTime:VIEW [1] :WINDow [1] :TRIGger [:STATe] ON OFF 1 0 :DISPlay:PVTime:VIEW [1] :WINDow [1] :TRIGger [:STATe] ?
Example:	:DISP:PVT:VIEW:WIND:TRIG ON :DISP:PVT:VIEW:WIND:TRIG?
Preset:	OFF
State Saved:	Saved in instrument state.
Range:	On Off
Initial S/W Revision:	A.03.00
Help Map ID:	40693

Burst Lines

Turns the burst lines On or Off. Please note, Burst Lines are just supported in RF Envelop window of Burst view.

Key Path:	View/Display
Mode:	LTETDD, LTE
Remote Command:	:DISPlay:PVTime:VIEW [1] :WINDow [1] :BLINes [:STATe] ON OFF 1 0 :DISPlay:PVTime:VIEW [1] :WINDow [1] :BLINes [:STATe] ?
Example:	:DISP:PVT:VIEW:WIND:BLIN ON :DISP:PVT:VIEW:WIND:BLIN?
Preset:	OFF
State Saved:	Saved in instrument state.
Range:	On Off
Initial S/W Revision:	A.03.00
Help Map ID:	40694

Limit Mask

Turns the limit mask On or Off. Please note, Trigger Lines are just supported in RF Envelop window of Burst view.

The limit mask shown on screen is just to indicate which part of signal is active burst and which part is inactive burst, the mask is nothing to do with the Pass/Fail(shown at the upper-left corner of screen)

criteria. Regarding the Pass/Fail criteria, please refer to Limits section “Limits” on page 710.

Key Path:	View/Display, Burst
Mode:	LTETDD, LTE
Remote Command:	:DISPlay:PVTTime:VIEW[1]:WINDow[1]:LIMit:MASK OFF ON 0 1 :DISPlay:PVTTime:VIEW[1]:WINDow[1]:LIMit:MASK?
Example:	DISP:PVT:VIEW:WIND:LIM:MASK 1 DISP:PVT:VIEW:WIND:LIM:MASK?
Notes:	This parameter only hides or shows the limit mask line on the display.
Preset:	ON
State Saved:	Saved in instrument state.
Range:	On Off
Initial S/W Revision:	A.03.00
Help Map ID:	40722

Rise & Fall View

This view has three windows:

Rising RF Envelope Window.	The parameters of this window are identical to those of the RF Window in the “Burst View” on page 736.
Falling RF Envelope Window.	The parameters of this window are identical to those of the RF Window in the “Burst View” on page 736.
Numeric Results Window.	The parameters of this window are identical to those of the Numeric Results Window in the “Burst View” on page 736.

The figure below shows an example of the Rise & Fall View.

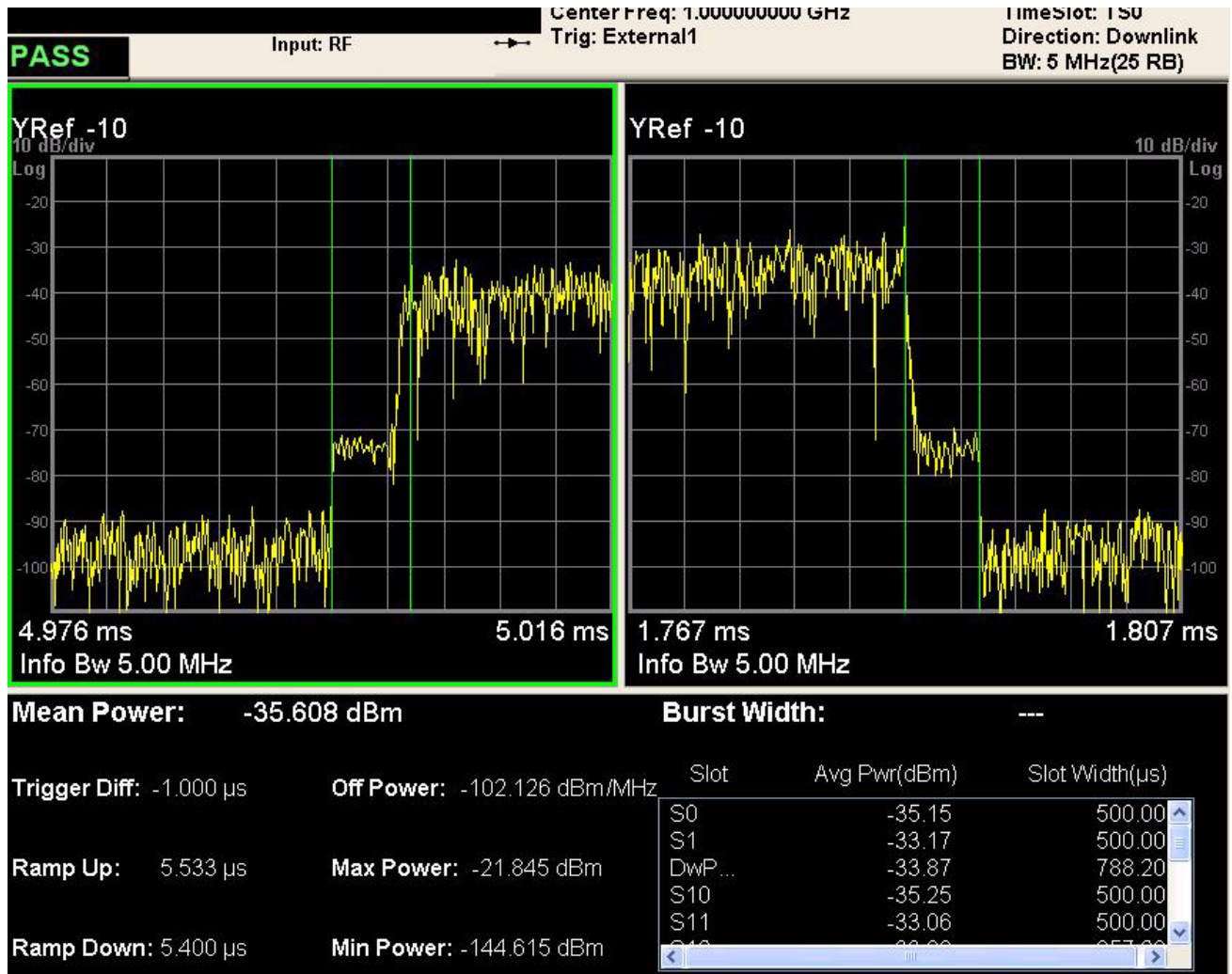

Key Path:	View/Display
Mode:	LTETDD, LTE
Initial S/W Revision:	Prior to A.02.00
Help Map ID:	40723

Ramp Lines

Turns the ramp lines On or Off.

Key Path:	View/Display
Mode:	LTETDD, LTE

Transmit On/Off Power Measurement
View/Display

Remote Command:	:DISPlay:PVTime:RAMP[:STATe] OFF ON 0 1 :DISPlay:PVTime:RAMP[:STATe]?
Example:	:DISP:PVT:RAMP ON :DISP:PVT:RAMP?
Preset:	OFF
State Saved:	Saved in instrument state.
Range:	On Off
Initial S/W Revision:	A.03.00
Help Map ID:	40695

Scroll

Accesses the Scroll menu, which contains features that enable you to navigate the display.

Key Path:	View/Display
Initial S/W Revision:	A.03.00
Help Map ID:	40696

Prev Page

Moves the display one page back to the previous page of the result metrics window.

Key Path:	View/Display, Scroll
Mode:	LTETDD, LTE
Initial S/W Revision:	A.03.00
Help Map ID:	40697

Next Page

Moves the display one page forward to the next page of the result metrics window.

Key Path:	View/Display, Scroll
Mode:	LTETDD, LTE
Initial S/W Revision:	A.03.00
Help Map ID:	40698

Scroll Up

Moves one line upward from the current line of the result metrics window.

Pressing the up arrow hard key has the same effect as this function, if no active function is shown. If an

active function is shown, the up arrow hard key controls the active function, but has no effect on line movement.

Scroll up soft key and up arrow hard key will only effective when Metrics window is focused.

Key Path:	View/Display, Scroll
Mode:	LTETDD, LTE
Initial S/W Revision:	A.03.00
Help Map ID:	40699

Scroll Down

Moves one line downward from the current line of the result metrics window.

Pressing the down arrow hard key has the same effect as this function, if no active function is shown. If an active function is shown, the up arrow hard key controls the active function, but has no effect on line movement, as the Scroll Down function does.

The scroll down soft key and down arrow hard key are only effective when the Metrics window is focused.

Key Path:	View/Display, Scroll
Mode:	LTETDD, LTE
Initial S/W Revision:	A.03.00
Help Map ID:	40700

First Page

Moves the display to the first page of the result metrics window.

Key Path:	View/Display, Scroll
Mode:	LTETDD, LTE
Initial S/W Revision:	A.03.00
Help Map ID:	40701

Last Page

Moves the display to the last page of the result metrics window.

Key Path:	View/Display, Scroll
Mode:	LTETDD, LTE
Initial S/W Revision:	A.03.00
Help Map ID:	40702

Transmit On/Off Power Measurement
View/Display

REPAIR FILE

This section contains the following topics:

[“Description” on page 747](#)

[“Remote Commands” on page 747](#)

[“Remote SCPI Results” on page 747](#)

Description

The LTE modulation analysis measurement enables you to measure LTE signals according to 3GPP TS 36.211. The measurement supports all LTE bandwidths plus all modulation formats and sequences for both downlink (OFDMA) and uplink (SC-FDMA) analysis. Once you have configured the measurement you can use these commands to initiate the measurement and retrieve the measurement results.

All of the scalar results for this measurement are contained in two tables: the Error Summary and Frame Summary; and each have an equivalent subopcode that is used to obtain the remote results. You can obtain the measurement results by either visually inspecting the corresponding summary trace on the display, or by using CALC:DATA queries that return descriptions of the corresponding summary trace.

Remote Commands

```
:CONFigure:EVM
:FETCh:EVM[n]?
:INITiate:EVM
:MEASure:EVM[n]?
:READ:EVM[n]?
:CALCulate:EVM:DATA<n>:TABLe:STRing?
:CALCulate:EVM:DATA<n>:TABLe:NAMes?
:CALCulate:EVM:DATA<n>:TABLe:UNIT?
:CALC:EVM:DATA4:TABL:STR? "FreqErr"
```

See [Remote SCPI Commands and Data Queries@30187](#) for more measurement SCPI commands.

Also see [Trace/Detector, Data@25798](#) for more measurement SCPI commands.

Remote SCPI Results

These standard remote results are also available thru the CALC:DATA<n> set of queries, where <n> is a reference to the trace number. The results assigned to each trace vary depending on which tests are enabled. As an example, with the default trace layout, the results in the Error Summary results are returned by CALC:EVM:DATA4:TABL:STR?

See the following section: [Remote SCPI Commands and Data Queries@30187](#).

The following table denotes the LTE Modulation Analysis specific results returned from the

(FETCh|MEASure|READ):EVM commands, indexed by subopcode. MEASure:EVM<n> performs the equivalent of CONF:EVM;INIT:IMM:FETCh:EVM<n>. This gets you the default measurement, which is a 5 MHz downlink with auto detection of allocations.

Note that valid results are only returned if the Symbols/Errors trace is being computed. It must be selected though it is not necessary for it to be shown in the current Layout. Some table results are string data, rather than numeric. As FETCh|MEASure|READ can only return numeric data, NaN is returned as a placeholder for string data. To get the full table data, including string results (with numbers in ASCII format) use the CALC:EVM:DATA<n>:TABL:STR? query. Use the associated

CALC:EVM:DATA<n>:TABL queries to get information about names and units for the table data.

N	Results Returned (Downlink)
Not specified or n=1	<p>Returns comma-separated scalar results, corresponding exactly to the items returned in the Error Summary:</p> <ol style="list-style-type: none"> 1. EVM (%rms) 2. String result (EVM Sym Time Adjust). NaN returned 3. EVM Pk (%) 4. EVM Pk Index 5. EVM Peak Sub Car Index 6. Data EVM (%rms) – Not available when Detection is Manual and no User is added. 7. 3GPP-defined QPSK EVM (%rms) 8. 3GPP-defined 16QAM EVM (%rms) 9. 3GPP-defined 64QAM EVM (%rms) 10. RS EVM (%rms) 11. RS Tx. Power (dBm). 12. OFDM Sym. Tx. Power (dBm). 13. Freq Error (Hz) 14. Sync Corr (%) 15. String Result (Sync Type). NaN returned. 16. Common Tracking Error (%rms) 17. Symbol Clock Error (ppm) 18. Time Offset (s) 19. IQ Offset (dB) 20. IQ Gain Imbalance (dB) 21. IQ Quad Error (deg) 22. IQ Timing Skew (s) 23. String result (CP Length Mode). NaN returned. 24. String result (Cell ID). NaN returned. 25. String result (Cell ID Group/Sector). NaN returned. 26. String result (RS-OS / PRS). NaN returned. 27. Reference Signal Rx Power (Avg). 28. Reference Signal Rx Quality (dB). 29. Received Signal Strength Indicator (dBm) <p>If the table has not been selected to appear on any trace, timeout will occur.</p>

N	Results Returned (Downlink)
n=2	Returns the results of the Frame Summary table in numeric format, with NaN in place of string results. Since this table changes depending on the Channel Profile Setup, the data names and units must be determined at run time by using CALC:EVM:DATA<k>:TABL queries

N	Results Returned (Uplink)
Not specified or n=1	<p>Returns comma-separated scalar results, corresponding exactly to the items returned in the Error Summary:</p> <ol style="list-style-type: none"> 1. EVM (%rms) 2. String result (EVM Sym Time Adjust). NaN returned 3. EVM Pk (%) 4. EVM Pk Index 5. EVM Peak Sub Car Index 6. Data EVM (%rms) – Not available when Detection is Manual and no User is added. 7. 3GPP-defined QPSK EVM (%rms) 8. 3GPP-defined 16QAM EVM (%rms) 9. 3GPP-defined 64QAM EVM (%rms) 10. RS EVM (%rms) 11. NaN returned. 12. NaN returned. 13. Freq Error (Hz) 14. Sync Corr (%) 15. String Result (Sync Type). NaN returned. 16. Common Tracking Error (%rms) 17. Symbol Clock Error (ppm) 18. Time Offset (s) 19. IQ Offset (dB) 20. IQ Gain Imbalance (dB) 21. IQ Quad Error (deg) 22. IQ Timing Skew (s) 23. String result (CP Length Mode). NaN returned. 24. Channel Power (dBm) <p>If the table has not been selected to appear on any trace, timeout will occur.</p>
n=2	Returns the results of the Frame Summary table in numeric format, with NaN in place of string results. Since this table changes depending on the Channel Profile Setup, the data names and units must be determined at run time by using CALC:EVM:DATA<k>:TABL queries

For more results defined for READ and FETCh, see the following section: [Remote SCPI Commands and Data Queries @ 30187](#).

Because the results of MEASure, READ, or FETCh queries are statically defined, you should use the following query:

CALCulate:EVM:DATA<n>:TABLe:STRing?

as this provides both string and numeric results (numeric formatted as ASCII), and the queries

CALCulate:EVM:DATA<n>:TABLe:NAMes?

CALCulate:EVM:DATA<n>:TABLe:UNIT?

to obtain lists of descriptive data names and associated units. For table results that can change dynamically, such as the Frame Summary, these provide the only possible way to interpret remote table data, since static tabulations such as those above will not suffice.

As an example of the above commands, if you have performed CONF:EVM;INIT:IMM;FORM ASCII, then the following commands will return results similar to those shown in the columns below. The FORM ASCII command dictates that the FETC results will be returned as ASCII in a comma-separated list. The CALC:EVM:DATA<n>:TABL query responses are a comma-separated list enclosed in quotes (i.e., they are a single string).

FETC:EVM1	CALC:EVM:DATA4 :TABL:STR?	CALC:EVM:DATA4 :TABL:UNIT?	CALC:EVM:DATA4 :TABL:NAM?
9.2223893260E+01	92.22389326	%rms	EVM
9.9100000000E+37	EVM Window End		EVMSymTimeAdj
4.2397593130E+02	423.9759313	%rms	EVMPeak
6.0000000000E+00	6	sym	EVMPeakIdx
2.1000000000E+01	21	subcar	EVMPeakSubcarIdx
8.6673950980E+01	86.67395098	%rms	DataEVM
7.6970986550E+01	76.97098655	%rms	RSEVM
6.6970986550E+01	66.97098655	%rms	3GPPEVMQPSK
9.6673950980E+01	96.67395098	%rms	3GPPEVM16QAM
2.8573950980E+01	28.57395098	%rms	3GPPEVM64QAM
3.9100000000E+01	3.91	dBm/subcar	RSTP
-20.4500000000E+01	-20.45	dBm	OSTP
8.4413310460E+02	844.1331046	Hz	FreqErr
1.0699478450E-01	0.106994784	%	SyncCorr
9.9100000000E+37	P-SS		SyncType
1.6618317400E+01	16.6183174	%rms	CTE

FETC:EVM1	CALC:EVM:DATA4 :TABL:STR?	CALC:EVM:DATA4 :TABL:UNIT?	CALC:EVM:DATA4 :TABL:NAM?
4.2218131000E+02	422.18131	ppm	SymClkErr
3.4869991450E-03	0.003486999	sec	TimeOffset
-2.2683995020E+01	-22.68399502	dB	IQOffset
-1.1367356920E-01	-0.113673569	dB	IQGainImb
-3.6632873820E-01	-0.366328738	deg	IQQuadErr
-2.6630113160E-09	-2.66E-09	sec	IQTimingSkew
9.9100000000E+37	Normal(auto)		CpLengthMode
9.9100000000E+37	503 (auto)		CellId
9.9100000000E+37	167/2 (auto)		CellIdGroupSector
9.9100000000E+37	Custom		RSPRS
-10.0380000000E+01	-10.038	dBm	RSRP
-6.4700000000E+01	-6.47	dB	RSRQ
-20.0500000000E+01	-20.05	dBm	RSSI

In addition, if just the “FreqErr” result is desired, you can obtain it using the command:

CALC:EVM:DATA4:TABL:STR? “FreqErr”

For the example data above, the response will be:

“844.1331046”

Key Path:	Meas
Mode:	LTE, LTETDD
Initial S/W Revision:	Prior to A.02.00
Modified at S/W Revision:	A.03.00, A.06.00, A.11.00
Help Map ID:	29080

AMPTD (Amplitude) Y Scale

See [AMPTD Y Scale@25884](#) for a description of this function.

Key Path:	Front Panel
Help Map ID:	Use 25884

Auto Couple

See [Auto Couple@3041@i](#) for a description of this function.

Key Path:	Front Panel
Help Map ID:	Use 3041

BW (Bandwidth)

The BW key provides access to a menu that enables you to set the FFT Window for the Spectrum and Inst Spectrum measurement results.

See [BW@25888](#) for more information.

Key Path:	Front Panel
Help Map ID:	Use 25888

Cont (Continuous)

See [Cont \(Continuous Measurement/Sweep\)@3309@i](#) for more information.

Key Path:	Front Panel
Help Map ID:	Use 3309

FREQ Channel

See [FREQ/Channel@25889](#) for a description of this function.

Key Path:	Front Panel
Help Map ID:	Use 25889

Center Freq

Sets the frequency of the display Center. See [Center Freq@25793@i](#) for more information.

Key Path:	FREQ Channel
Help Map ID:	Use 25793

Start Freq

Sets the frequency of the display Start.

Key Path:	FREQ Channel
Mode:	LTE, LTETDD
Remote Command:	[:SENSE] :FREQuency:STARt <freq> [:SENSe] :FREQuency:STARt?
Example:	FREQ:STAR 980 MHz FREQ:STAR?
Couplings:	Stop Freq, Center Freq, and Span. See “ FREQ Channel ” on page 757 for more details.
Preset:	Depends on span option. It is 1/2 max span below 1 GHz
State Saved:	Saved in instrument state.
Min:	-9.9e37
Max:	9.9e37
Initial S/W Revision:	Prior to A.02.00
Modified at S/W Revision:	A.02.00
Help Map ID:	29103

Stop Freq

Sets the frequency of the display Stop.

Key Path:	FREQ Channel
Mode:	LTE, LTETDD
Remote Command:	[:SENSE] :FREQuency:STOP <freq> [:SENSE] :FREQuency:STOP?
Example:	FREQ:STOP 990 MHz FREQ:STOP?
Couplings:	Start Freq, Center Freq, and Span. See “ FREQ Channel ” on page 757 for more details.
Preset:	Depends on span option. It is 1/2 max span above 1 GHz
State Saved:	Saved in instrument state.
Min:	-9.9e37
Max:	9.9e37
Initial S/W Revision:	Prior to A.02.00
Modified at S/W Revision:	A.02.00
Help Map ID:	29108

CF Step

Controls the amount the center frequency changes if it is the active function and the user presses the Up or Down arrow key. See [CF Step@25796](#) for more information.

Key Path:	FREQ Channel
Help Map ID:	29367

Input/Output

Provides a menu that enables you to select input/output parameters for the measurement data.

See [Input/Output@3065](#) for more information.

Key Path:	Front Panel
Help Map ID:	Use 3065

Marker

See [Marker@25859](#) for a description of this function.

Key Path:	Front Panel
Help Map ID:	Use 25859

Marker Function

See [Marker Function@25877](#) for a description of this function.

Key Path:	Front Panel
Help Map ID:	Use 25877

Marker -> (Marker To)

See [Marker To@25868](#) for a description of this function.

Key Path:	Front Panel
Help Map ID:	Use 25868

Meas (Measure)

See [Measure@4008@i](#) for a description of this function.

Key Path:	Front Panel
Help Map ID:	Use 4008

Meas Setup (Measurement Setup)

Displays a menu that enables you to select measurement parameters for the current measurement.

See [Meas Setup@25933@i](#) for more information.

Key Path:	Front Panel
Mode:	LTE, LTETDD
Initial S/W Revision:	Prior to A.02.00
Modified at S/W Revision:	A.03.00
Help Map ID:	Use 25933

Avg Number

Turns averaging on or off and sets the number of time record measurement results that will be averaged. There are no SCPI/features unique to this measurement.

See [Avg Number@25781](#) for more information.

Key Path:	Meas Setup
Mode:	LTE, LTETDD
Initial S/W Revision:	Prior to A.02.00
Modified at S/W Revision:	A.03.00
Help Map ID:	Use 25781

Averaging applies to a limited set of measurement results in LTE Modulation Analysis. RMS and Max average types apply to the Spectrum and Ch Frequency Response traces. The behavior for these types is the same as in the Vector Analysis Measurement. Averaging of numeric error data in the symbol table is described below:

Average Type	Average Mode	Effects of averaging
RMS	any (single sweep)	After each scan, the Syms/Err table shows a running (linear) average over past scans for each parameter in the table. Peak or position parameters are not averaged. Parameters that appear in the table in dB are converted to linear units in order to average them. The measurement stops after the specified Avg Number of scans.
RMS	repeat (continuous sweep)	Same as above, except that averages are reset after the specified Avg Number of scans, and the measurement continues.
RMS	exponential (continuous sweep)	Same as the single sweep case until the specified Avg Number of scans is complete. After that, averaging continues using exponential weighting.

Max	any	After each scan, compares each parameter in the table with the current scan's value and keeps the maximum. Symbol positions relate to the maximum peak value seen.
-----	-----	--

Average Mode

Average Mode determines what happens if the Sweep Control is in Continuous mode and the number of time records processed exceeds the Average Number. If the Sweep Control is in Single mode, this setting has no effect. There are no SCPI/features unique to this measurement.

See [Average Mode@25782](#) for more information.

Key Path:	Meas Setup
Help Map ID:	Use 25782

Average Setup

These parameters are for less commonly needed averaging setups. There are no SCPI/features unique to this measurement.

See [Average Setup@25899](#) for more information.

Key Path:	Meas Setup
Help Map ID:	Use 25899

Sync/Format Setup (Downlink)

Displays a menu of commonly used sync/format setup parameters when Direction is set to Downlink.

Key Path:	Meas Setup
Mode:	LTE, LTETDD
Initial S/W Revision:	Prior to A.02.00
Modified at S/W Revision:	A.03.00
Help Map ID:	29085

Sync Type

Selects the Sync Type.

- PSS – Selects Primary Sync Signal for Sync Type
- RS – Selects Reference Signal for Sync Type

Sync Type sets the channel or signal to be used for synchronization.

The LTE demodulator can be set to use either the Primary Sync signal (P-SS) or the Reference Signal (RS) to synchronize the downlink signal.

LTE Modulation Analysis Measurement
Meas Setup (Measurement Setup)

This synchronization is performed at the frame level. For smaller scale adjustments (such as at the symbol or slot level), see the “EVM Minimization” on page 1120 parameter.

P-SS is normally used for downlink synchronization. However, when P-SS is impaired in some way (for example, P-SS has a different “Cell ID” on page 768 from RS), RS can be used for synchronization so that the signal can be demodulated.

Note that S-SS must be present in the time capture (Raw Main Time) for demodulation to occur, since finding S-SS is the only way to distinguish between the beginning and the middle of a frame.

When Sync Type is set to RS:

The Error Summary data result SyncCorr shows which Tx antenna port’s reference signal was used for synchronization to the right of the correlation value.

Auto detection of Cell ID and Custom RS-PRS are not supported.

The reference Tx antenna port must be specified, since the demodulator does not automatically search the reference input channel for all Tx antenna ports when Sync Type is set to RS.

Key Path:	Meas Setup, Sync/Format Setup,
Mode:	LTE, LTETDD
Remote Command:	[:SENSE] :EVM:DLINK:SYNC:TYPE PSS RS [:SENSE] :EVM:DLINK:SYNC:TYPE?
Example:	EVM:DLIN:SYNC:TYPE PSS EVM:DLIN:SYNC:TYPE?
Dependencies:	When Sync Type is set to RS, auto detection of Cell ID and Custom RS-PRS are not supported.
Preset:	PSS
State Saved:	Saved in instrument state.
Range:	P-SS RS
Initial S/W Revision:	Prior to A.02.00
Modified at S/W Revision:	A.03.00
Help Map ID:	29127

P-SS

Selects P-SS Sync Type.

P-SS is the Primary Synchronization signal for an LTE downlink frame. The center 72 subcarriers (6 RB wide) are allocated to P-SS, but only the center 62 subcarriers are used. The unused subcarriers (the outer five on each side) are set to zero power during P-SS transmission. P-SS is not present in an uplink frame.

For FDD frame type 1, P-SS is present in the last symbol of slots 0 and 11 in every frame.

For TDD frame type 2, P-SS is present in the third symbol of slots 2 and 12 in every frame.

NOTE See [“Edit Control Channels” on page 805](#) for information on setting P-SS Power Boost.

P-SS is transmitted as a Zadoff-Chu sequence and thus appears as irregularly spaced points on a circle in the IQ Meas constellation diagram.

Key Path:	Meas Setup, Sync/Format Setup, Sync Type
Mode:	LTE, LTETDD
Initial S/W Revision:	Prior to A.02.00
Modified at S/W Revision:	A.03.00
Help Map ID:	29128

RS

Selects RS (Ref Signal) Sync Type.

RS is the downlink Cell-specific Reference Signal and is used for [“EVM Minimization” on page 1120](#) and Equalizer Training, and it can be used for synchronization. The reference signal is also used as the power level reference for the rest of the signal. See [“Edit Control Channels” on page 805](#) for more information.

The modulation type of RS is QPSK.

Key Path:	Meas Setup, Sync/Format Setup, Sync Type
Mode:	LTE, LTETDD
Initial S/W Revision:	Prior to A.02.00
Modified at S/W Revision:	A.03.00
Help Map ID:	29129

RS-PRS

Sets the RS-PRS.

- 3GPP – The demodulator will expect the RS pseudorandom sequence to follow the formula given in the LTE standard in Section 6.10.1.1 of 3GPP TS 36.211.
- CUSTom – The demodulator will autodetect the RS sequence (including non-standard sequences). Since the RS points can only be in certain positions, the demodulator will assume that the point closest to the measured point is the desired reference signal point and will calculate the EVM and other metrics using the assumed reference signal constellation point.

RS-PRS specifies whether or not the demodulator should expect the reference signal sequence to adhere to the standard.

NOTE When Sync Type is set to RS, autodetecting of a Custom RS-PRS is not supported

LTE Modulation Analysis Measurement
Meas Setup (Measurement Setup)

since the demodulator needs to know the RS-PRS to be able to synchronize the signal using RS.

When RS-PRS is set to Custom and any of the antenna port signals are phase delayed by more than 45 degrees, the demodulator will autodetect a different RS-PRS. This will cause equalization to be incorrect and demodulation will fail. To ensure correct demodulation of signals containing an antenna port transmission with a phase rotation of more than 45 degrees, set RS-PRS to 3GPP to enable RS-PRS to be determined by Cell ID according to the standard.

Key Path:	Meas Setup, Sync/Format Setup
Mode:	LTE, LTETDD
Remote Command:	[:SENSe] :EVM:DLINK:SYNC:RSPRS GPP CUSTom [:SENSe] :EVM:DLINK:SYNC:RSPRS?
Example:	EVM:DLIN:SYNC:RSPR CUSTom EVM:DLIN:SYNC:RSPR?
Dependencies:	When Sync Type for Downlink is set to RS, the Custom selection is disabled and the softkey is grayed out.
Preset:	GPP
State Saved:	Saved in instrument state.
Range:	3GPP Custom
Initial S/W Revision:	Prior to A.02.00
Modified at S/W Revision:	A.03.00
Help Map ID:	30750

Cell ID

Autodetects the Cell ID from the SSCH content or to manually select the Cell ID.

Cell ID sets the physical (PHY) layer Cell Identity. This PHY-layer Cell ID determines the Cell ID Group and Cell ID Sector. There are 168 possible Cell ID groups and 3 possible Cell ID sectors; therefore, there are $3 * 168 = 504$ possible PHY-layer Cell IDs. When Cell ID is set to Auto, the analyzer will automatically detect the Cell ID. When Cell ID is set to Manual, the PHY-layer Cell ID must be specified for successful demodulation.

The physical layer Cell ID can be calculated from the following formula:

$$\text{PHY-layer Cell ID} = 3 * (\text{Cell ID Group}) + \text{Cell ID Sector}$$

When Sync Type is set to RS, the Cell ID Auto selection will be disabled, and Cell ID must be specified manually. This is because the demodulator needs to know the values of the RS sequence to use for synchronization and because Cell ID determines these values. See “RS-PRS” on page 767 for more information.

NOTE Cell ID Sector and Group information can be found on the Error Summary trace.
 Only cell-specific reference signals are supported by the LTE demod (MBSFN and UE-specific reference signals are not supported).

Cell ID Sector determines the Zadoff-Chu Root Index used to generate the Primary Synchronization Signal (P-SS):

Cell ID sector 0 = ZC Root Index 25

Cell ID sector 1 = ZC Root Index 29

Cell ID sector 2 = ZC Root Index 34

Normally, the same sequence used to generate P-SS is used to generate RS, but a custom RS can be used by setting RS-PRS to Custom.

Key Path:	Meas Setup, Sync/Format Setup
Mode:	LTE, LTETDD
Remote Command:	[:SENSe] :EVM:DLINk:SYNC:CID <integer> [:SENSe] :EVM:DLINk:SYNC:CID? [:SENSe] :EVM:DLINk:SYNC:CID:AUTO OFF ON 0 1 [:SENSe] :EVM:DLINk:SYNC:CID:AUTO?
Example:	EVM:DLIN:SYNC:CID 0 EVM:DLIN:SYNC:CID? EVM:DLIN:SYNC:CID:AUTO ON
Dependencies:	When Sync Type for Downlink is set to RS, the Cell ID Auto selection is disabled and Cell ID must be specified manually.
Preset:	0 ON
State Saved:	Saved in instrument state.
Min:	0
Max:	503
Initial S/W Revision:	Prior to A.02.00
Modified at S/W Revision:	A.03.00
Help Map ID:	29091

Tx Antenna

Displays a menu of Tx Antenna parameters.

Key Path:	Meas Setup
Mode:	LTE, LTETDD
Initial S/W Revision:	Prior to A.02.00
Modified at S/W Revision:	A.03.00
Help Map ID:	30753

Number of Tx Antenna

Selects the number of Tx Antennas.

- ANT1 – 1 Antenna
- ANT2 – 2 Antennas
- ANT4 – 4 Antennas

Number of Tx Antenna specifies the number of transmit antenna ports there are for the current LTE signal.

This tells the demodulator whether the signal (or signals, for MIMO case) has been generated as single antenna signal or as a 2x or 4x antenna MIMO signal and therefore determines how many Tx antenna port signals the demodulator searches for.

NOTE When RS-PRS is set to Custom and any of the antenna port signals are phase delayed by more than 45 degrees, the demodulator will autodetect a different RS-PRS. This will cause equalization to be incorrect and demodulation will fail. To ensure correct demodulation of signals containing an antenna port transmission with a phase rotation of more than 45 degrees, set RS-PRS to 3GPP to enable RS-PRS to be determined by Cell ID according to the standard.

Key Path:	Meas Setup, Sync/Format Setup
Mode:	LTE, LTETDD
Remote Command:	[:SENSe] :EVM:DLINK:SYNC:ANTenna:NUMBer ANT1 ANT2 ANT4 [:SENSe] :EVM:DLINK:SYNC:ANTenna:NUMBer?
Example:	EVM:DLIN:SYNC:ANT:NUMB ANT1
Dependencies:	When Sync Type for Downlink is set to RS, the Custom selection is disabled and the softkey is grayed out.
Preset:	ANT1
State Saved:	Saved in instrument state.
Range:	1 Antenna 2 Antennas 4 Antennas

Initial S/W Revision:	Prior to A.02.00
Modified at S/W Revision:	A.03.00
Help Map ID:	29092

1 Antenna

Selects one TX Antenna.

Key Path:	Meas Setup, Sync/Format Setup, TX Antenna, Num Tx Antenna
Mode:	LTE, LTETDD
Initial S/W Revision:	Prior to A.02.00
Modified at S/W Revision:	A.03.00
Help Map ID:	30754

2 Antennas

Selects two TX Antennas.

Key Path:	Meas Setup, Sync/Format Setup, TX Antenna, Num Tx Antenna
Mode:	LTE, LTETDD
Initial S/W Revision:	Prior to A.02.00
Modified at S/W Revision:	A.03.00
Help Map ID:	30755

4 Antennas

Selects four TX Antennas.

Key Path:	Meas Setup, Sync/Format Setup, TX Antenna, Num Tx Antenna
Mode:	LTE, LTETDD
Initial S/W Revision:	Prior to A.02.00
Modified at S/W Revision:	A.03.00
Help Map ID:	30756

Reference Tx Antenna Port

Selects which Reference Tx Antenna Port to use.

- P0 – Antenna Port 0
- P1 – Antenna Port 1
- P2 – Antenna Port 2

LTE Modulation Analysis Measurement Meas Setup (Measurement Setup)

- P3 – Antenna Port 3

Reference Tx Antenna Port determines which path to use for synchronization and initial equalization and to show on certain non-MIMO traces (listed below).

Auto/Man selection enables you to specify whether the analyzer uses auto-detection or manual mode to determine the reference Tx antenna port.

Auto - The Tx antenna signal path with the strongest reference signal on the input signal.

Man – Selected Tx antenna port is used as the reference Tx antenna port.

The RS power of the current Tx path is used to set the reference level for the other Tx RS power levels. For example, when Tx port 0 is selected, the Tx0 section of MIMO Info Table will show 0 dB for RSPwr and the other Tx path's RSPwr will be expressed in dB relative to this 0 dB point.

NOTE	<p>In the absence of cross-channel paths (when connecting directory to the Tx antenna ports), make sure that the Tx path selected is present; otherwise, the signal will not be demodulated.</p> <p>When Sync Type is set to P-SS and Reference Tx Antenna Port is Auto, the demodulator will automatically detect the strongest Tx path to use for the reference path.</p> <p>When Sync Type is set to RS, reference path auto detection is not supported and the reference Tx antenna path must be specified manually.</p>
-------------	--

This parameter also determines which Tx path results are shown on the following Demod traces:

- Eq Chan Freq Resp
- Eq Chan Freq Resp Diff
- Eq Impulse Response
- Common Tracking Error
- Inst Eq Chan Freq Resp
- Inst Eq Chan Freq Resp Diff
- Freq Err per Slot

To show information for all detected antenna port signals, use the MIMO traces (Trace > Data > MIMO).

NOTE	<p>When the reference signal (RS) for the reference Tx-to-Rx path is not present in the signal, demodulation will fail.</p> <p>P-SS and S-SS must be present in the time capture (Raw Main Time) of one of the channels connected to the analyzer for successful demodulation to occur. For example, for two-channel transmit diversity signal that has P-SS and S-SS transmitted only on Tx port 1, the demodulator can analyze Tx port 1 without Tx</p>
-------------	---

port 0 connected, but not vice versa.

Key Path:	Meas Setup, Sync/Format Setup, Tx Antenna
Mode:	LTE, LTETDD
Remote Command:	[:SENSE] :EVM:DLINK:SYNC:ANTenna:PORT P0 P1 P2 P3 [:SENSE] :EVM:DLINK:SYNC:ANTenna:PORT? [:SENSE] :EVM:DLINK:SYNC:ANTenna:PORT:AUTO OFF ON 0 1 [:SENSE] :EVM:DLINK:SYNC:ANTenna:PORT:AUTO?
Example:	EVM:DLIN:SYNC:ANT:PORT P0 EVM:DLIN:SYNC:ANT:PORT?
Dependencies:	When Number of Tx Antenna is One, only Port 0 is enabled and the others are disabled. When Number of Tx Antenna is two, Port 0 and Port 1 are enabled and the others are disabled. When Number of Tx Antenna is four, all Ports are enabled.
Preset:	P0 ON
State Saved:	Saved in instrument state.
Range:	Port 0 Port 1 Port 2 Port 3
Initial S/W Revision:	Prior to A.02.00
Modified at S/W Revision:	A.03.00
Help Map ID:	29093

Port 0

Selects Port 0 for the TX Antenna Port.

Key Path:	Meas Setup, Sync/Format Setup, TX Antenna, TX Antenna Port
Mode:	LTE, LTETDD
Initial S/W Revision:	Prior to A.02.00
Modified at S/W Revision:	A.03.00
Help Map ID:	29104

Port 1

Selects Port 1 for the TX Antenna Port.

Key Path:	Meas Setup, Sync/Format Setup, TX Antenna, TX Antenna Port
Mode:	LTE, LTETDD

LTE Modulation Analysis Measurement
Meas Setup (Measurement Setup)

Initial S/W Revision:	Prior to A.02.00
Modified at S/W Revision:	A.03.00
Help Map ID:	29105

Port 2

Selects Port 2 for the TX Antenna Port.

Key Path:	Meas Setup, Sync/Format Setup, TX Antenna, TX Antenna Port
Mode:	LTE, LTETDD
Initial S/W Revision:	Prior to A.02.00
Modified at S/W Revision:	A.03.00
Help Map ID:	29106

Port 3

Selects Port 3 for the TX Antenna Port.

Key Path:	Meas Setup, Sync/Format Setup, TX Antenna, TX Antenna Port
Mode:	LTE, LTETDD
Initial S/W Revision:	Prior to A.02.00
Modified at S/W Revision:	A.03.00
Help Map ID:	29107

Antenna Detect Threshold

Sets the Antenna Detection Threshold.

Antenna Detection Threshold sets the threshold for transmit antenna port signal detection. The average RS power from a Tx antenna port has to be above the Antenna Detection Threshold to be detected by the demodulator. The threshold is specified relative to the average RS subcarrier power level of the reference antenna path selected.

For example, a combination of the transmissions from Ports 0–3 are being received, Antenna Detection Threshold is set to –10 dB, Reference Tx Antenna Port is set to Port 1. The demodulator will set the detection threshold 10 dB below the average RS power level of the reference antenna path (Tx1). Any other antenna port transmission paths with an average RS power level that is at or below this threshold will not be detected nor included in demodulation results. However, any undetected transmissions will affect EVM since they will not be equalized and will act as noise.

NOTE Include Inactive Antenna Paths can be used to show information about all Tx paths

on the MIMO trace.

Key Path:	Meas Setup, Sync/Format Setup, Tx Antenna,
Mode:	LTE, LTETDD
Remote Command:	[:SENSe] :EVM:DLINk:SYNC:ANTenna:DETECT:THReshold <rel_ampl> [:SENSe] :EVM:DLINk:SYNC:ANTenna:DETECT:THReshold?
Example:	EVM:DLIN:SYNC:ANT:DET:THR -10 EVM:DLIN:SYNC:ANT:DET:THR?
Dependencies:	This parameter is disabled when Number of Tx Antenna is One.
Preset:	-10
State Saved:	Saved in instrument state.
Min:	-100 dB
Max:	100 dB
Initial S/W Revision:	Prior to A.02.00
Modified at S/W Revision:	A.03.00
Help Map ID:	30757

P-SS/S-SS Antenna Port

Selects the Antenna Port that is transmitting P-SS/S-SS when the Number of Tx Antenna is set to 2 Antennas or 4 Antennas.

When All Ports is selected, the Power Boost value for P-SS and S-SS entered in Downlink Control Channel Properties is assumed to be split equally among the transmit antennas.

For example, when P-SS Power Boost = 0.6 dB and P-SS/S-SS Antenna Port is set to All Ports for a four antenna port signal, the demodulator will expect P-SS power on each antenna port to be 0.6 dB – 6.02 dB = -5.38 dB.

Otherwise, when Port 0, Port 1, Port 2, or Port 3 is selected, the entire power specified by the P-SS and S-SS Power Boost parameter is assumed to be transmitted on the selected antenna port.

- PORT0 – Port 0
- PORT1 – Port 1
- PORT2 – Port 2
- PORT3 – Port 3
- APORts – All Ports

Key Path:	Meas Setup, Sync/Format Setup, Tx Antenna
Mode:	LTE, LTETDD

LTE Modulation Analysis Measurement
Meas Setup (Measurement Setup)

Remote Command:	[:SENSe] :EVM:DLINK:SYNC:SS:ANTenna:PORT P0 P1 P2 P3 APORts [:SENSe] :EVM:DLINK:SYNC:SS:ANTenna:PORT?
Example:	EVM:DLIN:SYNC:SS:ANT:PORT P0 EVM:DLIN:SYNC:SS:ANT:PORT?
Dependencies:	Disabled when Number of Tx Antenna is One.
Preset:	P0
State Saved:	Saved in instrument state.
Range:	Port 0 Port 1 Port 2 Port 3 All Ports
Initial S/W Revision:	A.03.00
Help Map ID:	40750

Port 0

Selects Port 0.

Key Path:	Meas Setup, Sync/Format Setup, Tx Antenna, P-SS/S-SS Ant
Mode:	LTE, LTETDD
Initial S/W Revision:	A.03.00
Help Map ID:	40751

Port 1

Selects Port 1.

Key Path:	Meas Setup, Sync/Format Setup, Tx Antenna, P-SS/S-SS Ant
Mode:	LTE, LTETDD
Initial S/W Revision:	A.03.00
Help Map ID:	40752

Port 2

Selects Port 2.

Key Path:	Meas Setup, Sync/Format Setup, Tx Antenna, P-SS/S-SS Ant
Mode:	LTE, LTETDD
Dependencies:	Disabled when Number of Tx Antenna is Two.
Initial S/W Revision:	A.03.00
Help Map ID:	40753

Port 3

Selects Port 3.

Key Path:	Meas Setup, Sync/Format Setup, Tx Antenna, P-SS/S-SS Ant
Mode:	LTE, LTETDD
Dependencies:	Disabled when Number of Tx Antenna is Two.
Initial S/W Revision:	A.03.00
Help Map ID:	40754

All Ports

Selects All Ports.

Key Path:	Meas Setup, Sync/Format Setup, Tx Antenna, P-SS/S-SS Ant
Mode:	LTE, LTETDD
Initial S/W Revision:	A.03.00
Help Map ID:	40755

Include Inactive Antenna Paths

Selects whether or not inactive antenna paths are included in the result.

- Include - All Tx/Rx antenna paths are shown on the MIMO traces whether or not the path is present.
- Exclude - Only Tx/Rx antenna paths that have an average RS power above the antenna detection threshold will be shown on the MIMO traces.

Key Path:	Meas Setup, Sync/Format Setup, Tx Antenna
Mode:	LTE, LTETDD
Remote Command:	[:SENSE] :EVM:DLINk:SYNC:ANTenna:INACTive:PATHs INCLude EXCLude [:SENSE] :EVM:DLINk:SYNC:ANTenna:INACTive:PATHs?
Example:	EVM:DLIN:SYNC:ANT:INAC:PATH INCL EVM:DLIN:SYNC:ANT:INAC:PATH?
Preset:	EXCLude
State Saved:	Saved in instrument state.
Range:	Include Exclude
Initial S/W Revision:	A.06.00
Help Map ID:	29083

MIMO Decoding

Determines the MIMO decoding method.

- NONE – No decoding
- GPPMimo – Selects 3GPP MIMO decoding

MIMO Decoding determines how much of the transmit chain is decoded by the demodulator. The selection of this parameter directly affects what values are shown on the IQ Meas trace and all other traces that depend on the IQ Meas data (error vector traces).

MIMO Decoding applies to multi-antenna signals only.

3GPP MIMO Decoding

When 3GPP MIMO Decoding is selected, the data points shown on the IQ Meas trace are equivalent to the data points before precoding was applied in the transmit chain. In other words, the demodulator will undo MIMO precoding and show the results on IQ Meas. Although the data points are mapped onto "subcarriers" when being shown on the layer traces, the data points do not have a one-to-one correspondence to the subcarrier that they are mapped onto. For instance, when there is a frequency null that affects a subcarrier, there will be several (depending on the precoding) data points in IQ Meas that are affected. Another way of looking at this is that each subcarrier contains information from multiple data points after precoding is performed (this does not apply to RS, P-SS, and S-SS which do not undergo precoding).

For channels that undergo transmit diversity, the demodulator will undo transmit diversity precoding, undo codeword-to-layer mapping, and show the resulting codeword data points in their respective resource elements, copied on all layer traces. That is, constellation points on layer traces for transmit diversity-precoded channels will be the same for all layer traces.

When a signal uses Tx Diversity, the amount of data transmitted is not increased, but the reliability of the signal is increased by transmitting multiple copies of the data.

In two Tx Antenna mode, each antenna port transmission carries enough information to determine all the data.

In four Tx Antenna mode, each antenna port transmission only carries enough information to determine half the data. Any data that cannot be determined from the detected antenna ports will be considered part of Non-Alloc signals and shown as blanks on the Symbol Table (unless the Non-Alloc parameter is selected; then the data will be shown as gray zeros).

For channels that undergo spatial multiplexing, the demodulator will only undo Spatial Multiplexing precoding and show the layer data points in their respective resource elements on the appropriate layer traces.

For precoded channels, subcarrier points on the layer traces do not have a one-to-one correspondence to on-air subcarriers. Rather, each subcarrier point is actually the demodulated value of a codeword data point that was present prior to the codeword-to-layer mapping at the transmitter.

NOTE	For LTE signals that contain more than one layer, the P-SS and S-SS subcarriers from the P-SS/S-SS Antenna Port are copied to all layer traces. RS subcarriers from all Tx antenna ports are copied to their respective subcarrier/symbol locations
-------------	---

in all layer traces.

No Decoding

When No Decoding is selected, no decoding or cross-channel equalization will be performed on the measured IQ data. This means that, for LTE signals that have been precoded (multi-antenna signals), subcarrier points shown on measured IQ traces (IQ Meas and IQ MEas Time) will actually be an addition of multiple modulation points, resulting in non-standard constellations.

For example, in a two antenna port signal, there will be subcarrier points that are an addition of two QPSK points. The resulting diagram will be a 9QAM constellation. These are effectively the points that were transmitted on the OFDM subcarriers.

Reference antenna path equalization will still be performed when Equalizer Training is enabled (set to RS or RS+Data).

The No Decoding selection is useful for the case that you have four antenna signals, and you want to isolate channel effects from transmit chain effects (filters, mixers, etc.). You could connect each transmit port directly to your measurement instrument with identical cables. That way, any observed anomalies will come primarily from the RF transmit chain.

NOTE When No Decoding is selected, EVM results will not be relevant since the ideal symbol points (shown on the IQ Ref and IQ Ref Time), which are used to compute EVM, will still be standard constellation points and hence may not match the non-standard constellation points of IQ Meas arising due to No Decoding.

Key Path:	Meas Setup, Sync/Format Setup
Mode:	LTE, LTETDD
Remote Command:	[:SENSe] :EVM:DLINk:SYNC:MIMO:DECoding NONE GPPMimo [:SENSe] :EVM:DLINk:SYNC:MIMO:DECoding?
Example:	EVM:DLIN:SYNC:MIMO:DEC NONE EVM:DLIN:SYNC:MIMO:DEC?
Notes:	The selection "JEQualizer" is removed at A.06.00. For backward compatibility, when it is sent, this parameter is set to GPPM, the Preset value.
Preset:	3GPP MIMO
State Saved:	Saved in instrument state.
Range:	None 3GPP MIMO
Initial S/W Revision:	A.03.00
Modified at S/W Revision:	A.06.00
Help Map ID:	40756

PDSCH Cell Specific Ratio

Determines PDSCH cell-specific ratio B/A or cell-specific parameter PB. (3GPP TS 36.213 V8.5.0 5.2) PDSCH cell-specific ratio specifies the power ratio between PDSCH resource elements and cell-specific reference signal elements.

- R1 – Cell-specific ratio B/A = always 1 (0 dB)
- PB0 – Cell-specific parameter PB = 0
- PB1 – Cell-specific parameter PB = 1
- PB2 – Cell-specific Parameter PB = 2
- PB3 – Cell-specific parameter PB = 3

When PB(x) is selected, the LTE parameter P_B will be set to (x), and the ratio B/A will be determined from Table 5.2–2 in 3GPP TS.36.213.

When R1 is selected, the cell-specific ratio B/A will be set to 1.

Key Path:	Meas Setup, Sync/Format Setup
Mode:	LTE, LTETDD
Remote Command:	[:SENSE] :EVM:DLINK:PDSCh:CSRatio R1 PB0 PB1 PB2 PB3 [:SENSE] :EVM:DLINK:PDSCh:CSRatio?
Example:	EVM:DLIN:PDSCh:CSR R1 EVM:DLIN:PDSCh:CSR?
Preset:	$B/A = 1$
State Saved:	Saved in instrument state.
Range:	$B/A = 1$ PB = 0 PB = 1 PB = 2 PB = 3
Initial S/W Revision:	A.03.00
Help Map ID:	40757

Sync/Format Setup (Uplink)

Displays a menu of commonly used sync/format setup parameters when Direction is set to Uplink.

Key Path:	Meas Setup
Mode:	LTE, LTETDD
Initial S/W Revision:	Prior to A.02.00
Modified at S/W Revision:	A.03.00
Help Map ID:	29130

Sync Type (Uplink)

Selects the Sync Type to use.

- RS – Selects PUSCH DM-RS as the Sync Type
- PUCCh – Selects PUCCH DM-RS as the Sync Type
- SRS – Selects S-RS as the Sync Type
- PRACH – Selects PRACH as the Sync Type

Sync Type sets the channel or signal to use for synchronization.

The demodulator can use PUSCH DM-RS, PUCCH DM-RS, S-RS, or PRACH for synchronization. Only the channels or signals that are defined for the current user (by selecting the Active to On for that signal in the User Mapping Editor) will be available as synchronization options.

Note that PUSCH, PUCCH, PUSCH DM-RS, PUCCH DM-RS, and SRS powers in the User Mapping Editor are specified relative to the 0 dB level determined by the power of the channel chosen for synchronization. For example, when:

- Sync Type is set to PUCCH DM-RS
- PUCCH DMRS Power (dB) = 3 dB
- PUSCH Power (dB) = 1.2 dB,

the demodulator will set the 0 dB level to be 3 dB below the average power of PUCCH DM-RS and expect PUSCH average power to be 1.2 dB above the 0 dB level, which is equivalent to 1.8 dB below the average PUCCH DM-RS power.

Sync Type also determines which channel's Sync Slot parameter is used for frame boundary calculation.

Key Path:	Meas Setup, Sync/Format Setup
Mode:	LTE, LTETDD
Remote Command:	[:SENSE] :EVM:ULINK:SYNC:TYPE RS PUCCh SRS PRACH [:SENSe] :EVM:ULINK:SYNC:TYPE?
Example:	EVM:ULIN:SYNC:TYPE RS EVM:ULIN:SYNC:TYPE?
Dependencies:	Only the channels or signals that are defined for the current user (by turn on Active for that signal in the LTE Allocation Editor) are available as synchronization options. For example, if a user does not have a PUCCH allocation defined, the PUCCH DM-RS synchronization option is disabled
Preset:	RS
State Saved:	Saved in instrument state.
Range:	PUSCH DM-RS PUCCH DM-RS S-RS PRACH
Initial S/W Revision:	Prior to A.02.00

LTE Modulation Analysis Measurement
Meas Setup (Measurement Setup)

Modified at S/W Revision:	A.03.00
Help Map ID:	29137

PUSCH DM-RS

Selects PUSCH DM-RS as the Sync Type.

Key Path:	Meas Setup, Sync/Format Setup, Sync Type
Mode:	LTE, LTETDD
Initial S/W Revision:	Prior to A.02.00
Modified at S/W Revision:	A.03.00
Help Map ID:	29138

PUCCH DM-RS

Selects PUCCH DM-RS as the Sync Type.

Key Path:	Meas Setup, Sync/Format Setup, Sync Type
Mode:	LTE, LTETDD
Initial S/W Revision:	Prior to A.02.00
Modified at S/W Revision:	A.03.00
Help Map ID:	29139

S-RS

Selects S-RS as the Sync Type.

Key Path:	Meas Setup, Sync/Format Setup, Sync Type
Mode:	LTE, LTETDD
Initial S/W Revision:	A.03.00
Help Map ID:	40758

PRACH

Selects PRACH as the Sync Type.

Key Path:	Meas Setup, Sync/Format Setup, Sync Type
Mode:	LTE, LTETDD
Initial S/W Revision:	A.03.00
Help Map ID:	40759

Half Subcarrier Shift

Sets the state of Half Carrier Shift. When Half Subcarrier Shift is selected, the demodulator expects the uplink signal to comply with the LTE standard regarding subcarrier shift and phase reset. The LTE standard requires that the uplink subcarriers be spaced on either side of DC by half the subcarrier spacing. When this is done, a phase reset is also needed after each symbol.

To demodulate a signal that does not shift the subcarriers by half the subcarrier spacing (and therefore does not need a phase reset), set this parameter to OFF.

To demodulate a signal that conforms to the half subcarrier shift, but does not reset the phase each symbol, set this parameter to OFF. The signal will then be demodulated correctly, but will show a frequency offset error of 7.5 KHz.

Background

Downlink signals have an odd number of subcarriers, and the middle subcarrier, located at DC, is discarded, since it is generally difficult to recover the data from a DC subcarrier. In contrast, uplink signals have one less subcarrier than the corresponding downlink signal and are shifted down in frequency by half the subcarrier spacing such that the subcarriers are symmetric about DC causing less bandwidth to be wasted.

Key Path:	Meas Setup, Sync/Format Setup
Mode:	LTE, LTETDD
Remote Command:	[:SENSe] :EVM:ULINk:SYNC:HSSHift OFF ON 0 1 [:SENSe] :EVM:ULINk:SYNC:HSSHift?
Example:	EVM:ULIN:SYNC:HSSH ON EVM:ULIN:SYNC:HSSH?
Preset:	ON
State Saved:	Saved in instrument state.
Initial S/W Revision:	Prior to A.02.00
Modified at S/W Revision:	A.03.00
Help Map ID:	29135

PUSCH DFT Swap

Sets the state of PUSCH DFT Swap. PUSCH DFT Swap influences how data is mapped to the subcarriers in the Physical Uplink Shared Channel after a discrete Fourier transform is performed. It can be turned on or off to provide two different interpretation of how data should be mapped to resource elements in PUSCH channels.

Key Path:	Meas Setup, Sync/Format Setup
Mode:	LTE, LTETDD

LTE Modulation Analysis Measurement
Meas Setup (Measurement Setup)

Remote Command:	[:SENSE] :EVM:ULINK:SYNC:PDSWap OFF ON 0 1 [:SENSE] :EVM:ULINK:SYNC:PDSWap?
Example:	EVM:ULIN:SYNC:PDSW ON EVM:ULIN:SYNC:PDSW?
Preset:	OFF
State Saved:	Saved in instrument state.
Initial S/W Revision:	Prior to A.02.00
Modified at S/W Revision:	A.03.00
Help Map ID:	29136

Meas Time Setup

Displays a menu of commonly used measurement time setup parameters.

Key Path:	Meas Setup
Mode:	LTE, LTETDD
Initial S/W Revision:	Prior to A.02.00
Modified at S/W Revision:	A.03.00
Help Map ID:	29141

Result Length

Sets the maximum result length for analysis.

Result Length determines how many slots will be available for demodulation. Measurement Interval and Measurement Offset specify what part of the result length is demodulated.

The result data starts where the analysis boundary is found and ends after the amount of data specified by Result Length.

The length of the time capture (contained in Search Time) is longer than the result length by approximately the length of the Analysis Start Boundary (frame = 10 ms, slot = 0.5 ms, etc.) to enable for location of the analysis boundary within the time capture.

NOTE For downlink, an entire slot containing S-SS must be present in the time capture (Raw Main Time) for demodulation to occur.

For LTETDD, the maximum Result Length is 40 slots when Direction is set to Downlink, for Uplink, the maximum Result Length is 20 slots.

Key Path:	Meas Setup, Meas Time Setup
Mode:	LTE, LTETDD

Remote Command:	[:SENSE] :EVM:TIME:RESult:LENGth <integer> [:SENSe] :EVM:TIME:RESult:LENGth?
Example:	EVM:TIME:RES:LENG 20 EVM:TIME:RES:LENG?
Preset:	20 slots
State Saved:	Saved in instrument state.
Min:	1 slot
Max:	LTE: 20 slots LTETDD: 40 slots for Downlink, 20 slots for Uplink
Initial S/W Revision:	Prior to A.02.00
Modified at S/W Revision:	A.03.00
Help Map ID:	29142

Meas Offset Slot

Sets the Meas Offset Slot.

Measurement Offset Slot specifies the offset from the Analysis Start Boundary to the beginning of the Measurement Interval (the data sent to the demodulator), and can be specified in slots + symbols-times.

Key Path:	Meas Setup, Meas Time Setup
Mode:	LTE, LTETDD
Remote Command:	[:SENSE] :EVM:TIME:OFFSet:SLOT <integer> [:SENSe] :EVM:TIME:OFFSet:SLOT?
Example:	EVM:TIME:OFFS:SLOT 0 EVM:TIME:OFFS:SLOT?
Couplings:	Max value determined by Result Length (refer to “Result Length” on page 784)
Preset:	0 slots
State Saved:	Saved in instrument state.
Min:	0 slots
Max:	Determined by Result Length (refer to “Result Length” on page 784)
Max:	Determined by Result Length (refer to “Result Length” on page 784)
Initial S/W Revision:	Prior to A.02.00
Modified at S/W Revision:	A.03.00
Help Map ID:	29143

Meas Offset Symbol

Sets the Meas Offset Symbol.

Measurement Offset Symbol specifies the offset from the Analysis Start Boundary to the beginning of the Measurement Interval (the data sent to the demodulator), and can be specified in slots + symbols-times.

Key Path:	Meas Setup, Meas Time Setup
Mode:	LTE, LTETDD
Remote Command:	[:SENSe] :EVM:TIME:OFFSet:SYMBOL <integer> [:SENSe] :EVM:TIME:OFFSet:SYMBOL?
Example:	EVM:TIME:OFFS:SYMB 0 EVM:TIME:OFFS:SYMB?
Preset:	0 symbols
State Saved:	Saved in instrument state.
Min:	0 symbols
Max:	6 symbols
Initial S/W Revision:	Prior to A.02.00
Modified at S/W Revision:	A.03.00
Help Map ID:	29144

Meas Interval Slot

Sets the Meas Interval Slot.

Measurement Interval determines how much data is sent to the demodulator, and can be specified in slots + symbols-times. The beginning of the measurement interval is specified as an offset from the Analysis Start Boundary. The offset is specified by the Measurement Offset parameter.

NOTE The Time Offset data result in the Error Summary trace shows the distance from the beginning of the Search Time trace to the beginning of the measurement interval.

Key Path:	Meas Setup, Meas Time Setup
Mode:	LTE, LTETDD
Remote Command:	[:SENSe] :EVM:TIME:INTerval:SLOT <integer> [:SENSe] :EVM:TIME:INTerval:SLOT?
Example:	EVM:TIME:INT:SLOT 1 EVM:TIME:INT:SLOT?

Couplings:	Max value determined by Result Length (refer to “Result Length” on page 784)
Preset:	LTE: 6 slots LTETDD: 6 slots
State Saved:	Saved in instrument state.
Min:	0 slots
Max:	Determined by Result Length (refer to “Result Length” on page 784)
Max:	Determined by Result Length (refer to “Result Length” on page 784)
Initial S/W Revision:	Prior to A.02.00
Modified at S/W Revision:	A.03.00
Help Map ID:	29145

Meas Interval Symbol

Sets the Meas Interval Symbol.

Measurement Interval determines how much data after the measurement offset is sent to the demodulator, and can be specified in slots + symbols-times.

Key Path:	Meas Setup, Meas Time Setup
Mode:	LTE, LTETDD
Remote Command:	[:SENSE] :EVM:TIME:INTerval:SYMBOL <integer> [:SENSE] :EVM:TIME:INTerval:SYMBOL?
Example:	EVM:TIME:INT:SYMB 0 EVM:TIME:INT:SYMB?
Preset:	0 symbols
State Saved:	Saved in instrument state.
Min:	0 symbols
Max:	6 symbols
Initial S/W Revision:	Prior to A.02.00
Modified at S/W Revision:	A.03.00
Help Map ID:	29146

Analysis Start Boundary

Sets the Analysis Start Boundary. Analysis Start Boundary specifies the alignment boundary of the Result Length time data. To ensure that this alignment can be achieved, the total amount of data acquired by the analyzer is equal to the Result Length plus the length of the alignment boundary specified by Analysis Start Boundary. For example, if Analysis Start Boundary were set to Half-Frame, the total

LTE Modulation Analysis Measurement
Meas Setup (Measurement Setup)

acquisition will be equal to ResultLength + 10 slots (and the Measurement Interval will start at a Half-Frame boundary).

Once the Result Length is located within the time capture, Measurement Offset and Measurement Interval determine the data that is to be analyzed. This data is also displayed on the Time trace.

This parameter cannot be set to Slot for downlink signals since MIMO Decoding must be applied beginning at a subframe boundary.

NOTE Since uplink signals do not contain a separate synchronization channel, the demodulator cannot determine the frame boundary exactly unless there is a unique slot in a user mapping and that unique slot is present within the Search Time data.

Key Path:	Meas Setup, Meas Time Setup
Mode:	LTE, LTETDD
Remote Command:	[:SENSE] :EVM:TIME:ASBoundary FRAME HALF SUB SLOT [:SENSE] :EVM:TIME:ASBoundary?
Example:	EVM:TIME:ASB FRAM EVM:TIME:ASB?
Dependencies:	When Direction is set to Downlink, SLOT cannot be selected and the softkey is grayed out. When Direction is changed to Downlink from Uplink, this parameter is set to FRAME.
Preset:	FRAME
State Saved:	Saved in instrument state.
Range:	Frame Half-Frame SubFrame Slot
Initial S/W Revision:	Prior to A.02.00
Modified at S/W Revision:	A.03.00
Help Map ID:	29147

Frame

Selects Frame as Analysis Start Boundary.

Key Path:	Meas Setup, Meas Time Setup, Analysis Start Boundary
Mode:	LTE, LTETDD
Initial S/W Revision:	Prior to A.02.00
Modified at S/W Revision:	A.03.00
Help Map ID:	29148

Half-Frame

Selects Half-Frame as Analysis Start Boundary.

Key Path:	Meas Setup, Meas Time Setup, Analysis Start Boundary
Mode:	LTE, LTETDD
Initial S/W Revision:	Prior to A.02.00
Modified at S/W Revision:	A.03.00
Help Map ID:	29149

SubFrame

Selects SubFrame as Analysis Start Boundary.

Key Path:	Meas Setup, Meas Time Setup, Analysis Start Boundary
Mode:	LTE, LTETDD
Initial S/W Revision:	Prior to A.02.00
Modified at S/W Revision:	A.03.00
Help Map ID:	29150

Slot

Selects Slot as Analysis Start Boundary. This selection is available when Direction is Uplink.

Key Path:	Meas Setup, Meas Time Setup, Analysis Start Boundary
Mode:	LTE, LTETDD
Initial S/W Revision:	Prior to A.02.00
Modified at S/W Revision:	A.03.00
Help Map ID:	29151

Chan Profile Setup (Downlink)

Displays a menu of commonly used channel profile setup parameters when Direction is Downlink.

Key Path:	Meas Setup
Mode:	LTE, LTETDD
Initial S/W Revision:	Prior to A.02.00
Modified at S/W Revision:	A.03.00
Help Map ID:	29262

Detection

Determines whether or not the user allocations will be autodetected.

Downlink:

When enabled, the demodulator can perform power based auto detection or can auto detect allocations by decoding PDCCH. See the [“RB Auto Detect Mode” on page 791](#) Detect Mode for more information.

Uplink:

When enabled, PUSCH, PUCCH, SRS, and PRACH allocations can be autodetected when the necessary parameters are defined.

NOTE	<p>The LTE demodulator can perform sync slot auto detection or user-assigned auto detection for uplink signals.</p> <p>To configure automatic sync slot detection, select the Auto Sync parameter on the User Mapping Editor.</p> <p>To configure user-assigned auto detection, set the Auto Sync to OFF for a channel and define a sync slot with associated Per-slot Parameters (in the User Mapping Editor) to be used for initial synchronization. User-assigned auto detection results in faster measurements than automatic sync slot detection.</p>
-------------	--

Key Path:	Meas Setup, Chan Profile Setup
Mode:	LTE, LTETDD
Remote Command:	[:SENSe] :EVM:PROFile:AUTO [:DETeCt] OFF ON 0 1 [:SENSe] :EVM:PROFile:AUTO [:DETeCt] ?
Example:	EVM:PROF:AUTO ON EVM:PROF:AUTO?
Couplings:	<p>This parameter is the same for Downlink and Uplink</p> <p>When Direction is Downlink, this parameter is coupled to the Include User (Downlink) menu. This menu is context sensitive and when Auto Include is on the user can include QPSK, 16QAM or 64QAM channels. When Off the user can include any of the user defined PDSCH channels.</p> <p>When direction is Uplink, this parameter is coupled to the Include User (Uplink) menu. This menu is context sensitive and when Auto Include is On the user can include channels from the Auto Detected User. When Off the user can include channels from ONE of the user defined Users.</p>
Preset:	ON
State Saved:	Saved in instrument state.
Initial S/W Revision:	Prior to A.02.00
Modified at S/W Revision:	A.03.00

Help Map ID:	29131
--------------	-------

RB Auto Detect Mode

Sets the level of auto detection that the LTE demodulator uses. There are two levels of auto detection, described as follows:

- **POWER** - Power Based, User allocations are detected using codeword power levels and MIMO parameters. Detected allocations are grouped according to modulation type (QPSK, 16QAM, or 64QAM).
 The codeword powers (needed for EVM calculations) and Precoding type are not autodetected and need to be specified.
 When SpMux is selected as the precoding type, No. Layers, No. Codewords, CDD, and Codebook Idx must also be specified, and these parameters are assumed to apply to all autodetected PDSCH channels.
- **DECode** - Decoded PDCCH, User allocations are determined by decoding PDCCH.

NOTE The demodulator can be configured to autodetect 3GPP-defined codeword power levels when Auto Detect Power Levels is On. When codeword power levels are not autodetected, they must be specified using the CW0/1 Power parameters in the User Mapping Editor for each expected user allocation. The number of expected user allocations is set by Number of Expected DL Users and by selecting the individual users.

Key Path:	Meas Setup, Chan Profile Setup
Mode:	LTE, LTETDD
Remote Command:	[:SENSe] :EVM:DLINk:PROFile:AUTO [:DETeCt] :MODE POWer DECodeD [:SENSe] :EVM:DLINk:PROFile:AUTO [:DETeCt] :MODE?
Example:	EVM:DLIN:PROF:AUTO:MODE POW EVM:DLIN:PROF:AUTO:MODE?
Dependencies:	Available when Detection is Auto.
Preset:	POWER
State Saved:	Saved in instrument state.
Range:	Power Based Decoded PDCCH
Initial S/W Revision:	A.06.00
Help Map ID:	29084

Auto Detect Power Levels

Selects whether or not power levels are autodetected.

LTE Modulation Analysis Measurement
Meas Setup (Measurement Setup)

- ON - Detects the relative PDSCH power level for each user allocation (P_A). RB Auto Detect Mode must be set to Decode PDCCH for power levels to be autodetected.
- OFF - The codeword power levels for each user allocation need to be specified for EVM calculations to be correct. The Expected Num. of Users parameter determines the number of users listed in the LTE Allocation Editor for which the power levels can be defined.

The power levels are detected as one of the levels specified by the standard in 3GPP TS 36.331, section 6.3.2 under the PDSCH-Config parameter.

These power levels are -6 dB, -4.77 dB, -3 dB, -1.77 dB, 0 dB, 1 dB, 2 dB, and 3 dB.

The autodetected power levels ($P_{A(n)}$) can be viewed on the DL Decode Info trace.

Key Path:	Meas Setup, Chan Profile Setup
Mode:	LTE, LTETDD
Remote Command:	[:SENSe] :EVM:DLINk:PROFile:AUTO [:DETECT] :POWER OFF ON 0 1 [:SENSe] :EVM:DLINk:PROFile:AUTO [:DETECT] :POWER?
Example:	EVM:DLIN:PROF:AUTO:POW ON EVM:DLIN:PROF:AUTO:POW?
Dependencies:	Available Detection is Auto and RB Auto Detect Mode is Decoded PDCCH.
Preset:	ON
State Saved:	Saved in instrument state.
Range:	On Off
Initial S/W Revision:	A.06.00
Help Map ID:	29090

Round to Standard Values

Determines whether the measured, relative power levels for PDSCH allocations are detected as one of the standard values or assumed to be equal to the measured power level.

When on, the power levels are detected as the closest standard power level. Standard power levels are specified in 3GPP TS 36.331, section 6.3.2 under the PDSCH-Config parameter. These power levels are -6 dB, -4.77 dB, -3 dB, -1.77 dB, 0 dB, 1 dB, 2 dB, and 3 dB. When off, the measured power levels are used as the actual power levels.

Key Path:	Meas Setup, Chan Profile Setup
Mode:	LTE, LTETDD
Remote Command:	[:SENSe] :EVM:DLINk:PROFile:AUTO [:DETECT] :POWER:ROUND OFF ON 0 1 [:SENSe] :EVM:DLINk:PROFile:AUTO [:DETECT] :POWER:ROUND?

Example:	EVM:DLIN:PROF:AUTO:POW:ROUN ON EVM:DLIN:PROF:AUTO:POW:ROUN?
Dependencies:	Available when the following conditions are met. Direction: Downlink Detection: Auto RB Auto Detect Mode: Decoded PDCCH Auto Detect Power Levels: On.
Preset:	ON
State Saved:	Saved in instrument state.
Range:	On Off
Initial S/W Revision:	A.10.00
Help Map ID:	40765

Number of Expected DL Users

Specifies the number of user allocations from 1 to 50 when RB Auto Detect Mode is set to Decoded PDCCH.

Other user allocations detected from PDCCH will be shown on traces and included in calculations, but only the number of users specified with this key will be included in the Composite Include menu where they can be excluded from traces and calculations.

When Auto Detect Power levels is set to OFF, PDSCH Decoded User Power Boost must be specified. This parameter limits the number of PDSCH user allocations for which codeword power levels can be manually defined. When there are more user allocations found in the signal than are specified by this parameter, any additional user allocation will be assumed to have a PDSCH power level of 0 dB.

Key Path:	Meas Setup, Chan Profile Setup
Mode:	LTE, LTETDD
Remote Command:	[:SENSe] :EVM:DLINk:PROFile:EUSers:COUNT <integer> [:SENSe] :EVM:DLINk:PROFile:EUSers:COUNT?
Example:	EVM:DLIN:PROF:EUS:COUN 1 EVM:DLIN:PROF:EUS:COUN?
Dependencies:	Available when Detection is Auto and RB Auto Detect Mode is Decoded PDCCH.
Preset:	3
State Saved:	Saved in instrument state.
Min:	0
Max:	50

LTE Modulation Analysis Measurement
Meas Setup (Measurement Setup)

Initial S/W Revision:	A.06.00
Help Map ID:	29094

Composite Include

Displays a menu that enables the inclusion or exclusion of all channels.

Key Path:	Meas Setup, Chan Profile Setup
Mode:	LTE, LTETDD
Initial S/W Revision:	Prior to A.02.00
Modified at S/W Revision:	A.03.00
Help Map ID:	29132

Include All

Turns On all Downlink channels.

Key Path:	Meas Setup, Chan Profile Setup, Composite Include
Mode:	LTE, LTETDD
Remote Command:	[:SENSE] :EVM:DLINK:PROFIlE:INCLude:ALL
Example:	EVM:DLIN:PROFIlE:INCL:ALL
Couplings:	Turns On the following parameters Include P-SCH Include S-SCH Include PBCH Include PCFICH Include PHICH Include RS Include PDCCH All Users under the Include Users (Downlink) Menu
Initial S/W Revision:	Prior to A.02.00
Modified at S/W Revision:	A.03.00
Help Map ID:	29133

Exclude All

Turns Off all Downlink channels.

Key Path:	Meas Setup, Chan Profile Setup, Composite Include
-----------	--

Mode:	LTE, LTETDD
Remote Command:	[:SENSe] :EVM:DLINk:PROFile:EXCLude:ALL
Example:	EVM:DLIN:PROF:EXCL:ALL
Couplings:	Turns Off the following parameters Include P-SCH Include S-SCH Include PBCH Include PCFICH Include PHICH Include RS Include PDCCH Include Non Allocation All Users under the Include Users (Downlink) Menu
Initial S/W Revision:	Prior to A.02.00
Modified at S/W Revision:	A.03.00
Help Map ID:	29134

Include Channels

Displays a menu that enables you to determine which channels should be included in the results.

Key Path:	Meas Setup, Chan Profile Setup
Mode:	LTE, LTETDD
Initial S/W Revision:	Prior to A.02.00
Modified at S/W Revision:	A.03.00
Help Map ID:	40967

Include P-SS

Includes the Primary Synchronization Channel in the results.

Key Path:	Meas Setup, Chan Profile Setup, Include Channels
Mode:	LTE, LTETDD
Remote Command:	[:SENSe] :EVM:DLINk:PROFile:PSS INCLude EXCLude [:SENSe] :EVM:DLINk:PROFile:PSS?
Example:	EVM:DLIN:PROF:PSS INCL EVM:DLIN:PROF:PSS?

LTE Modulation Analysis Measurement
Meas Setup (Measurement Setup)

Couplings:	This parameter is set to Include when Downlink Include All is selected and set to Exclude when Downlink Exclude All is selected.
Preset:	INCLude
State Saved:	Saved in instrument state.
Range:	Include Exclude
Initial S/W Revision:	Prior to A.02.00
Modified at S/W Revision:	A.03.00
Help Map ID:	29140

Include S-SS

Includes the Secondary Synchronization Channel in the results.

Key Path:	Meas Setup, Chan Profile Setup, Include Channels
Mode:	LTE, LTETDD
Remote Command:	[:SENSe] :EVM:DLINk:PROFile:SSS INCLude EXCLude [:SENSe] :EVM:DLINk:PROFile:SSS?
Example:	EVM:DLIN:PROF:SSS INCL EVM:DLIN:PROF:SSS?
Couplings:	This parameter is set to Include when Downlink Include All is selected and set to Exclude when Downlink Exclude All is selected.
Preset:	INCLude
State Saved:	Saved in instrument state.
Range:	Include Exclude
Initial S/W Revision:	Prior to A.02.00
Modified at S/W Revision:	A.03.00
Help Map ID:	29153

Include PBCH

Includes PBCH in the results.

Key Path:	Meas Setup, Chan Profile Setup, Include Channels
Mode:	LTE, LTETDD
Remote Command:	[:SENSe] :EVM:DLINk:PROFile:PBCH INCLude EXCLude [:SENSe] :EVM:DLINk:PROFile:PBCH?

Example:	EVM:DLIN:PROF:PBCH INCL EVM:DLIN:PROF:PBCH?
Couplings:	This parameter is set to Include when Downlink Include All is selected and set to Exclude when Downlink Exclude All is selected.
Preset:	INCLude
State Saved:	Saved in instrument state.
Range:	Include Exclude
Initial S/W Revision:	Prior to A.02.00
Modified at S/W Revision:	A.03.00
Help Map ID:	29154

Include PCFICH

Includes PCFICH in the results.

Key Path:	Meas Setup, Chan Profile Setup, Include Channels
Mode:	LTE, LTETDD
Remote Command:	[:SENSE] :EVM:DLINK:PROfile:PCFich INCLude EXCLude [:SENSE] :EVM:DLINK:PROfile:PCFich?
Example:	EVM:DLIN:PROF:PCF INCL EVM:DLIN:PROF:PCF?
Couplings:	This parameter is set to Include when Downlink Include All is selected and set to Exclude when Downlink Exclude All is selected.
Preset:	INCLude
State Saved:	Saved in instrument state.
Range:	Include Exclude
Initial S/W Revision:	Prior to A.02.00
Modified at S/W Revision:	A.03.00
Help Map ID:	29155

Include PHICH

Includes PHICH in the results.

Key Path:	Meas Setup, Chan Profile Setup, Include Channels
Mode:	LTE, LTETDD

LTE Modulation Analysis Measurement
Meas Setup (Measurement Setup)

Remote Command:	[:SENSe] :EVM:DLINK:PROFile:PHIC INCLude EXCLude [:SENSe] :EVM:DLINK:PROFile:PHIC?
Example:	EVM:DLIN:PROF:PHIC INCL EVM:DLIN:PROF:PHIC?
Couplings:	This parameter is set to Include when Downlink Include All is selected and set to Exclude when Downlink Exclude All is selected.
Preset:	INCLude
State Saved:	Saved in instrument state.
Range:	Include Exclude
Initial S/W Revision:	Prior to A.02.00
Modified at S/W Revision:	A.03.00
Help Map ID:	29156

Include RS

Includes RS in the results.

Key Path:	Meas Setup, Chan Profile Setup, Include Channels
Mode:	LTE, LTETDD
Remote Command:	[:SENSe] :EVM:DLINK:PROFile:RS INCLude EXCLude [:SENSe] :EVM:DLINK:PROFile:RS?
Example:	EVM:DLIN:PROF:RS INCL EVM:DLIN:PROF:RS?
Couplings:	This parameter is set to Include when Downlink Include All is selected and set to Exclude when Downlink Exclude All is selected.
Preset:	INCLude
State Saved:	Saved in instrument state.
Range:	Include Exclude
Initial S/W Revision:	Prior to A.02.00
Modified at S/W Revision:	A.03.00
Help Map ID:	29159

Include PDCCH

Includes PDCCH in the results.

Key Path:	Meas Setup, Chan Profile Setup, Include Channels
-----------	---

Mode:	LTE, LTETDD
Remote Command:	[:SENSE] :EVM:DLINK:PROF:ile:PDCCh INCLude EXCLude [:SENSE] :EVM:DLINK:PROF:ile:PDCCh?
Example:	EVM:DLIN:PROF:PDCC INCL EVM:DLIN:PROF:PDCC?
Couplings:	This parameter is set to Include when Downlink Include All is selected and set to Exclude when Downlink Exclude All is selected.
Preset:	INCLude
State Saved:	Saved in instrument state.
Range:	Include Exclude
Initial S/W Revision:	Prior to A.02.00
Modified at S/W Revision:	A.03.00
Help Map ID:	29160

Include P-RS

Includes the Position Reference Channel in the results.

Key Path:	Meas Setup, Chan Profile Setup, Include Channels
Mode:	LTE, LTETDD
Remote Command:	[:SENSE] :EVM:DLINK:PROF:ile:PRS INCLude EXCLude [:SENSE] :EVM:DLINK:PROF:ile:PRS?
Example:	EVM:DLIN:PROF:PRS INCL EVM:DLIN:PROF:PRS?
Dependencies:	Available when P-RS Active is On. Otherwise, this key is grayed out.
Couplings:	This parameter is set to Include when Downlink Include All is selected and set to Exclude when Downlink Exclude All is selected.
Preset:	EXCLude
State Saved:	Saved in instrument state.
Range:	Include Exclude
Initial S/W Revision:	A.11.00
Help Map ID:	40904

LTE Modulation Analysis Measurement
Meas Setup (Measurement Setup)

Include MBSFN –RS

Includes the MBSFN-RS channel in the results.

Key Path:	Meas Setup, Chan Profile Setup, Include Channels
Mode:	LTE, LTETDD
Remote Command:	[:SENSE] :EVM:DLINK:PROF: MBSFN INCLude EXCLude [:SENSE] :EVM:DLINK:PROF: MBSFN?
Example:	EVM:DLIN:PROF:MBSF INCL EVM:DLIN:PROF:MBSF?
Dependencies:	Available when MBSFN Active is On. Otherwise, this key is grayed out.
Couplings:	This parameter is set to Include when Downlink Include All is selected and set to Exclude when Downlink Exclude All is selected.
Preset:	EXCLude
State Saved:	Saved in instrument state.
Range:	Include Exclude
Initial S/W Revision:	A.11.00
Help Map ID:	40905

Include PMCH

Includes the PMCH channel in the results.

Key Path:	Meas Setup, Chan Profile Setup, Include Channels
Mode:	LTE, LTETDD
Remote Command:	[:SENSE] :EVM:DLINK:PROF: PMCH INCLude EXCLude [:SENSE] :EVM:DLINK:PROF: PMCH?
Example:	EVM:DLIN:PROF:PMCH INCL EVM:DLIN:PROF:PMCH?
Dependencies:	Available when MBSFN Active is On. Otherwise, this key is grayed out.
Couplings:	This parameter is set to Include when Downlink Include All is selected and set to Exclude when Downlink Exclude All is selected.
Preset:	EXCLude
State Saved:	Saved in instrument state.
Range:	Include Exclude
Initial S/W Revision:	A.11.00
Help Map ID:	40906

Include Non Allocation

Includes the inactive signals in the results.

Key Path:	Meas Setup, Chan Profile Setup, Include Channels
Mode:	LTE, LTETDD
Remote Command:	[:SENSe] :EVM:PROFile:NALLocation INCLude EXCLude [:SENSe] :EVM:PROFile:NALLocation?
Example:	EVM:PROF:NALL EXCL EVM:PROF:NALL?
Couplings:	This parameter is same for Downlink and Uplink When either Downlink Exclude All or Uplink Exclude All is selected, this parameter is set to Exclude.
Preset:	EXCLude
State Saved:	Saved in instrument state.
Range:	Include Exclude
Initial S/W Revision:	Prior to A.02.00
Modified at S/W Revision:	A.03.00
Help Map ID:	29184

Include Users (Downlink)

Displays a menu that enables you to determine which PDSCH channels should be included in the results.

When set to Include, the corresponding user mapping is displayed on appropriate traces. When set to Exclude, only the Frame Summary trace will display the user mapping.

Key Path:	Meas Setup, Chan Profile Setup
Mode:	LTE, LTETDD
Initial S/W Revision:	Prior to A.02.00
Modified at S/W Revision:	A.03.00
Help Map ID:	29172

User

Indexes the currently defined Users.

Key Path:	Meas Setup, Chan Profile Setup, Include Users
Mode:	LTE, LTETDD

LTE Modulation Analysis Measurement
Meas Setup (Measurement Setup)

Dependencies:	Available when Detection is Manual. You need to set allocations to the user in advance. Otherwise, this key is grayed out.
Couplings:	Max value determined by the number of Users the user has configured
Preset:	0
State Saved:	Saved in instrument state.
Min:	1
Max:	Determined by the number of Users the user has configured
Initial S/W Revision:	Prior to A.02.00
Modified at S/W Revision:	A.03.00
Help Map ID:	29176

Include PDSCH

Includes the user defined channel PDSCH in the results.

Key Path:	Meas Setup, Chan Profile Setup, Include Users
Mode:	LTE, LTETDD
Remote Command:	[:SENSe] :EVM:DLINk:PROFile:USER<n>:PDSCh INCLude EXCLude [:SENSe] :EVM:DLINk:PROFile:USER<n>:PDSCh?
Example:	EVM:DLIN:PROF:USER1:PDSC EXCL EVM:DLIN:PROF:USER1:PDSC?
Dependencies:	The range of sub op code <n> values is determined by the number of Users the user has configured. If the user attempts to remotely set or query a sub op code that is out of range, this will result in an error message. Available when Detection is Manual. You need to set allocations to the user in advance. Otherwise, this key is grayed out.
Couplings:	This parameter is set to Include when Downlink Include All is selected and set to Exclude when Downlink Exclude All is selected.
Preset:	EXCLude
State Saved:	Saved in instrument state.
Range:	Include Exclude
Initial S/W Revision:	Prior to A.02.00
Modified at S/W Revision:	A.03.00
Help Map ID:	29185

Include Decoded PDSCH

Includes the user defined channel Decoded PDSCH in the results.

Key Path:	Meas Setup, Chan Profile Setup, Include Users
Mode:	LTE, LTETDD
Remote Command:	[:SENSe] :EVM:DLINk:PROFile:USER<n>:DECoded:PDSCh INCLude EXCLude [:SENSe] :EVM:DLINk:PROFile:USER<n>:DECoded:PDSCh?
Example:	EVM:DLIN:PROF:USER1:DEC:PDSC EXCL EVM:DLIN:PROF:USER1:DEC:PDSC?
Dependencies:	The range of sub op code <n> values is determined by the Number of Expected DL Users the user has configured. If the user attempts to remotely set or query a sub op code that is out of range, this will result in an error message. Available When Detection is Auto, RB Auto Detect Mode is Decoded PDCCH, User and Decoded PDSCH are available.
Couplings:	This parameter is set to Include when Downlink Include All is selected, and set to Exclude when Downlink Exclude All is selected.
Preset:	INCLude
State Saved:	Saved in instrument state.
Range:	Include Exclude
Initial S/W Revision:	A.06.00
Help Map ID:	29095

Include QPSK

Includes channels using QPSK Mod Type in the results.

Key Path:	Meas Setup, Chan Profile Setup, Include Users
Mode:	LTE, LTETDD
Remote Command:	[:SENSe] :EVM:DLINk:PROFile:QPSK INCLude EXCLude [:SENSe] :EVM:DLINk:PROFile:QPSK?
Example:	EVM:DLIN:PROF:QPSK INCL EVM:DLIN:PROF:QPSK?
Dependencies:	Enabled when PDSCH Detection is Auto.
Couplings:	This parameter is set to Include when Downlink Include All is selected and set to Exclude when Downlink Exclude All is selected.
Preset:	INCLude

LTE Modulation Analysis Measurement
Meas Setup (Measurement Setup)

State Saved:	Saved in instrument state.
Range:	Include Exclude
Initial S/W Revision:	Prior to A.02.00
Modified at S/W Revision:	A.03.00
Help Map ID:	29173

Include 16QAM

Includes channels using 16QAM Mod Type in the results.

Key Path:	Meas Setup, Chan Profile Setup, Include Users
Mode:	LTE, LTETDD
Remote Command:	[:SENSE] :EVM:DLINK:PROF:QAM16 INCLude EXCLude [:SENSE] :EVM:DLINK:PROF:QAM16?
Example:	EVM:DLIN:PROF:QAM16 INCL EVM:DLIN:PROF:QAM16?
Dependencies:	Enabled when PDSCH Detection is Auto.
Couplings:	This parameter is set to Include when Downlink Include All is selected and set to Exclude when Downlink Exclude All is selected.
Preset:	INCLude
State Saved:	Saved in instrument state.
Range:	Include Exclude
Initial S/W Revision:	Prior to A.02.00
Modified at S/W Revision:	A.03.00
Help Map ID:	29174

Include 64QAM

Includes channels using 64QAM Mod Type in the results.

Key Path:	Meas Setup, Chan Profile Setup, Include Users
Mode:	LTE, LTETDD
Remote Command:	[:SENSE] :EVM:DLINK:PROF:QAM64 INCLude EXCLude [:SENSE] :EVM:DLINK:PROF:QAM64?
Example:	EVM:DLIN:PROF:QAM64 INCL EVM:DLIN:PROF:QAM64?
Dependencies:	Enabled when Downlink Detection is Auto.

Couplings:	This parameter is set to Include when Downlink Include All is selected and set to Exclude when Downlink Exclude All is selected.
Preset:	INCLude
State Saved:	Saved in instrument state.
Range:	Include Exclude
Initial S/W Revision:	Prior to A.02.00
Modified at S/W Revision:	A.03.00
Help Map ID:	29175

Edit Control Channels

Displays a dialog that enables you to edit the Downlink Control Channel parameters. When a parameter is selected, the corresponding softkeys will appear.

You can set the Power Boost parameter for P-SS, S-SS, PBCH, PCFICH, RS, PDCCH, and PHICH. There are also several other PDCCH and PHICH parameters.

Power Boost (for all physical channels except PHICH) specifies the expected average subcarrier power of a channel. When there are multiple antenna ports, the Power Boost value is split equally over all antenna ports.

For example, PBCH Power Boost is set to 0 dB. For a single-antenna signal, the expected average subcarrier power of PBCH would be 0 dB, but for a two-antenna signal, the expected average subcarrier power of PBCH per antenna port would be -3 dB.

This is done so that specifying a channel's Power Boost parameter is like specifying the average power of the channel being transmitted from the base station regardless of the number of transmit antennas.

NOTE When P-SS/S-SS Antenna Port is set to Port 0–3, the P-SS/S-SS Power Boost parameter specifies the expected average subcarrier power of P-SS/S-SS on the specified antenna port (in other words, the value is not split across all antenna ports). However, when P-SS/S-SS Antenna Port is set to All Port, then the Power Boost value is split across all antenna ports like the other channels.

Other power boost parameters are expressed relative to the 0 dB level set by RS Power Boost. A value of 2.5 dB for RS Power Boost specifies that the 0 dB level is set to be 2.5 dB below the measured RS power level.

For example, setting PBCH Power Boost to 0.5 dB for a single-antenna signal when RS Power Boost is set to 2.5 dB tells the demodulator to expect the PBCH power level to be 0.5 dB above the 0 dB level (which is 2.0 dB below the measured RS power level).

Use **Tab** key to select a parameter field to edit. The rotary knob can be also used to select a parameter field as it has two functions: value adjustment (default) and field navigation. Use **Enter** key to toggle the function.

In order to apply or discard changes, select OK button or Cancel button on the editor to show the corresponding softkeys and press either of them. These softkeys also appear by pressing **Cancel (Esc)**

LTE Modulation Analysis Measurement
Meas Setup (Measurement Setup)

key when the active function is disabled.

NOTE If Help is open when you select this key, the dialog and menu does not appear. Close Help by pressing **Cancel (Esc)**, then select this key. After the menu has changed, press the green **Help** key to see Help for the dialog and keys. Close Help when you are ready to edit the parameters.

Key Path:	Meas Setup, Chan Profile Setup, More
Mode:	LTE, LTETDD
Initial S/W Revision:	Prior to A.02.00
Modified at S/W Revision:	A.03.00
Help Map ID:	29186

P-SS Power Boost

Sets the Power Boost value for the P-SS.

Key Path:	Meas Setup, Chan Profile Setup, Edit Control Channels, P-SS
Mode:	LTE, LTETDD
Remote Command:	[:SENSE] :EVM:DLINK:PROFile:PSS:PWRBoost <rel_ampl> [:SENSE] :EVM:DLINK:PROFile:PSS:PWRBoost?
Example:	EVM:DLIN:PROF:PSS:PWRB 0.65 EVM:DLIN:PROF:PSS:PWRB?
Notes:	Changes to this parameter will not be applied until Update Changes command is sent. See “RB Parameter Manager (Downlink)” on page 915 section for more details.
Preset:	0 dB
State Saved:	Saved in instrument state.
Min:	-100 dB
Max:	100 dB
Initial S/W Revision:	Prior to A.02.00
Modified at S/W Revision:	A.03.00, A.04.20
Help Map ID:	29177

S-SS Power Boost

Sets the Power Boost value for the S-SS.

Key Path:	Meas Setup, Chan Profile Setup, Edit Control Channels, S-SS
-----------	--

Mode:	LTE, LTETDD
Remote Command:	[:SENSE] :EVM:DLINK:PROfile:SSS:PWRBoost <rel_ampl> [:SENSE] :EVM:DLINK:PROfile:SSS:PWRBoost?
Example:	EVM:DLIN:PROF:SSS:PWRB 0.65 EVM:DLIN:PROF:SSS:PWRB?
Notes:	Changes to this parameter willChanges to this parameter will not be applied until Update Changes command is sent. See “RB Parameter Manager (Downlink)” on page 915 section for more details.
Preset:	0 dB
State Saved:	Saved in instrument state.
Min:	-100 dB
Max:	100 dB
Initial S/W Revision:	Prior to A.02.00
Modified at S/W Revision:	A.03.00, A.04.20
Help Map ID:	29178

PBCH Power Boost

Sets the Power Boost value for the PBCH.

Key Path:	Meas Setup, Chan Profile Setup, Edit Control Channels, PBCH
Mode:	LTE, LTETDD
Remote Command:	[:SENSE] :EVM:DLINK:PROfile:PBCH:PWRBoost <rel_ampl> [:SENSE] :EVM:DLINK:PROfile:PBCH:PWRBoost?
Example:	EVM:DLIN:PROF:PBCH:PWRB 0 EVM:DLIN:PROF:PBCH:PWRB?
Notes:	Changes to this parameter willChanges to this parameter will not be applied until Update Changes command is sent. See “RB Parameter Manager (Downlink)” on page 915 section for more details.
Preset:	0 dB
State Saved:	Saved in instrument state.
Min:	-100 dB
Max:	100 dB
Initial S/W Revision:	Prior to A.02.00
Modified at S/W Revision:	A.03.00, A.04.20
Help Map ID:	29179

PCFICH Power Boost

Sets the Power Boost value for the PCFICH.

Key Path:	Meas Setup, Chan Profile Setup, Edit Control Channels, PCFICH
Mode:	LTE, LTETDD
Remote Command:	[:SENSE] :EVM:DLINK:PROFile:PCFich:PWRBoost <rel_ampl> [:SENSE] :EVM:DLINK:PROFile:PCFich:PWRBoost?
Example:	EVM:DLIN:PROF:PCF:PWRB 0 EVM:DLIN:PROF:PCF:PWRB?
Notes:	Changes to this parameter will not be applied until Update Changes command is sent. See “RB Parameter Manager (Downlink)” on page 915 section for more details.
Preset:	0 dB
State Saved:	Saved in instrument state.
Min:	-100 dB
Max:	100 dB
Initial S/W Revision:	Prior to A.02.00
Modified at S/W Revision:	A.03.00, A.04.20
Help Map ID:	29182

RS Power Boost

Sets the Power Boost value for the RS.

The 0 dB level is set by RS Power Boost. A value of 2.5 dB for RS Power Boost specifies that the 0 dB level is set to be 2.5 dB below the measured RS power level.

Other Power Boosts (P-SS, S-SS, PBCH, PCFICH, PDCCH and PHICH) are set relative to the 0 dB level. For example, setting PBCH Power Boost to 0.5 dB when RS Power Boost is set to 2.5 dB tells the demodulator to expect the average PBCH power level to be 0.5 dB above the 0 dB level (which is 2.5 dB below the measured RS power level).

Key Path:	Meas Setup, Chan Profile Setup, Edit Control Channels, RS
Mode:	LTE, LTETDD
Remote Command:	[:SENSE] :EVM:DLINK:PROFile:RS:PWRBoost <rel_ampl> [:SENSE] :EVM:DLINK:PROFile:RS:PWRBoost?
Example:	EVM:DLIN:PROF:RS:PWRB 2.50 EVM:DLIN:PROF:RS:PWRB?

Notes:	Changes to this parameter will not be applied until Update Changes command is sent. See “ RB Parameter Manager (Downlink) ” on page 915 section for more details.
Preset:	0 dB
State Saved:	Saved in instrument state.
Min:	-100 dB
Max:	100 dB
Initial S/W Revision:	Prior to A.02.00
Modified at S/W Revision:	A.03.00, A.04.20
Help Map ID:	29181

PDCCH

Displays a menu that enables the configuration of PDCCH parameters.

Key Path:	Meas Setup, Chan Profile Setup, Edit Control Channels
Mode:	LTE, LTETDD
Initial S/W Revision:	Prior to A.02.00
Modified at S/W Revision:	A.03.00
Help Map ID:	30812

PDCCH Power Boost

Sets the Power Boost value for the PDCCH.

When RB Auto Detect Mode is set to Decoded PDCCH, PDCCH power boost (see the section Edit Control Channels for description of Power Boost parameters) can be auto detected by specifying a starting value in this parameter and setting the granularity of the search in the PDCCH Power Boost Step. The demodulator will detect PDCCH power as

$$\text{PDCCH power} = (\text{PDCCH Power Boost} + k * \text{PDCCH Power Boost Step})$$

where k in the range $-10 \text{ dB} \leq k * \text{PDCCH Power Boost Step} \leq 10 \text{ dB}$ is the value that brings the equation closest to the actual PDCCH power.

Key Path:	Meas Setup, Chan Profile Setup, Edit Control Channels
Mode:	LTE, LTETDD
Remote Command:	[:SENSE] :EVM:DLINK:PROFile:PDCC:h:PWRBoost <rel_ampl> [:SENSE] :EVM:DLINK:PROFile:PDCC:h:PWRBoost?
Example:	EVM:DLIN:PROF:PDCC:PWRB 0 EVM:DLIN:PROF:PDCC:PWRB?

LTE Modulation Analysis Measurement
Meas Setup (Measurement Setup)

Notes:	Changes to this parameter will not be applied until Update Changes command is sent. See “ RB Parameter Manager (Downlink) ” on page 915 section for more details.
Preset:	0 dB
State Saved:	Saved in instrument state.
Min:	-100 dB
Max:	100 dB
Initial S/W Revision:	Prior to A.02.00
Modified at S/W Revision:	A.03.00, A.04.20
Help Map ID:	29180

PDCCH Power Boost Step (+/- Increments (dB))

Sets the Power Boost Step value for the PDCCH. See section “[PDCCH Power Boost](#)” on page 809 for more details.

Key Path:	Meas Setup, Chan Profile Setup, Edit Control Channels
Mode:	LTE, LTETDD
Remote Command:	[:SENSE] :EVM:DLINK:PROFfile:PDCCh:PWRBoost:STEP <rel_ampl> [:SENSE] :EVM:DLINK:PROFfile:PDCCh:PWRBoost:STEP?
Example:	EVM:DLIN:PROF:PDCC:PWRB:STEP 0 EVM:DLIN:PROF:PDCC:PWRB:STEP?
Notes:	Changes to this parameter will not be applied until Update Changes command is sent. See “ RB Parameter Manager (Downlink) ” on page 915 for more details.
Dependencies:	Available when Detection is Auto and RB Auto Detect Mode is Decoded PDCCH, or Detection is Auto and PDCCH Decoding is other than NONE.
Preset:	1 dB
State Saved:	Saved in instrument state.
Min:	-100 dB
Max:	100 dB
Initial S/W Revision:	A.10.00
Help Map ID:	40766

PDCCH Allocation Auto Detect

Determines whether or not the number of PDCCH symbols is autodetected. When On, the analyzer will autodetect the PDCCH allocations by decoding PCFICH.

To view the detected number of PDCCH allocations per subframe, use the # PDCCH SymPerSubframe data result

on the DL Decode Info summary table.

Key Path:	Meas Setup, Chan Profile Setup, Edit Control Channels Alloc
Mode:	LTE, LTETDD
Remote Command:	[:SENSE] :EVM:DLINK:PROFile:PDCCh:ALLocation:AUTO[:DETECT] OFF ON 0 1 [:SENSE] :EVM:DLINK:PROFile:PDCCh:ALLocation:AUTO[:DETECT] ?
Example:	EVM:DLIN:PROF:PDCC:ALL:AUTO 1 EVM:DLIN:PROF:PDCC:ALL:AUTO?
Notes:	Changes to this parameter will not be applied until Update Changes command is sent. See “RB Parameter Manager (Downlink)” on page 915 section for more details.
Preset:	ON
State Saved:	Saved in instrument state.
Range:	On Off
Initial S/W Revision:	A.06.00
Help Map ID:	29113

PDCCH Allocation Constant

Selects whether or not all the Subframes will use PDCCH Allocation Subframe 0 value.

Key Path:	Meas Setup, Chan Profile Setup, Edit Control Channels
Mode:	LTE
Remote Command:	[:SENSE] :EVM:DLINK:PROFile:PDCCh:ALLocation:CONSTant OFF ON 0 1 [:SENSE] :EVM:DLINK:PROFile:PDCCh:ALLocation:CONSTant?
Example:	EVM:DLIN:PROF:PDCC:ALL:CONS ON EVM:DLIN:PROF:PDCC:ALL:CONS?
Notes:	Changes to this parameter will not be applied until Update Changes command is sent. See “RB Parameter Manager (Downlink)” on page 915 section for more details.
Dependencies:	LTE FDD only. Available when PDCCH Allocation Auto Detect is Off.
Couplings:	When this parameter is On, all Subframes will use PDCCH Allocation Subframe 0 value.
Preset:	ON

LTE Modulation Analysis Measurement
Meas Setup (Measurement Setup)

State Saved:	Saved in instrument state.
Initial S/W Revision:	Prior to A.02.00
Modified at S/W Revision:	A.03.00
Help Map ID:	29116

PDCCH Allocation Subframe 0

Sets the PDCCH Allocation (Symbols per Subframe) for Subframe 0.

Key Path:	Meas Setup, Chan Profile Setup, Edit Control Channels
Mode:	LTE, LTETDD
Remote Command:	[:SENSe] :EVM:DLINk:PROFile:PDCCh:ALLocation:SUBFrame0:SYMBOLs <integer> [:SENSe] :EVM:DLINk:PROFile:PDCCh:ALLocation:SUBFrame0:SYMBOLs?
Example:	EVM:DLIN:PROF:PDCC:ALL:SUBF0:SYMB 1 EVM:DLIN:PROF:PDCC:ALL:SUBF0:SYMB?
Notes:	Changes to this parameter will not be applied until Update Changes command is sent. See “RB Parameter Manager (Downlink)” on page 915 section for more details.
Dependencies:	When PDCCH Allocation Constant is On, all subframes will use this value. Available when PDCCH Allocation Auto Detect is Off.
Preset:	3
State Saved:	Saved in instrument state.
Min:	0
Max:	3 – Bandwidth 3 MHz, 5 MHz, 10 MHz, 15 MHz, 20 MHz 4 – Bandwidth 1.4 MHz
Initial S/W Revision:	Prior to A.02.00
Modified at S/W Revision:	A.03.00
Help Map ID:	29263

PDCCH Allocation Subframe 1

Sets the PDCCH Allocation (Symbols per Subframe) for Subframe 1.

Key Path:	Meas Setup, Chan Profile Setup, Edit Control Channels
Mode:	LTE, LTETDD

Remote Command:	[:SENSE] :EVM:DLINK:PROFile:PDCCCh:ALLocation:SUBFrame1:SYMBOLs <integer> [:SENSE] :EVM:DLINK:PROFile:PDCCCh:ALLocation:SUBFrame1:SYMBOLs?
Example:	EVM:DLIN:PROF:PDCC:ALL:SUBF1:SYMB 1 EVM:DLIN:PROF:PDCC:ALL:SUBF1:SYMB?
Notes:	Changes to this parameter will not be applied until Update Changes command is sent. See “RB Parameter Manager (Downlink)” on page 915 section for more details.
Dependencies:	Available when both PDCCH Allocation Auto Detect and PDCCH Allocation Constant are OFF.
Preset:	3
State Saved:	Saved in instrument state.
Min:	0
Max:	3 – Bandwidth 3 MHz, 5 MHz, 10 MHz, 15 MHz, 20 MHz 4 – Bandwidth 1.4 MHz
Initial S/W Revision:	Prior to A.02.00
Modified at S/W Revision:	A.03.00
Help Map ID:	29118

PDCCH Allocation Subframe 2

Sets the PDCCH Allocation (Symbols per Subframe) for Subframe 2.

Key Path:	Meas Setup, Chan Profile Setup, Edit Control Channels
Mode:	LTE, LTETDD
Remote Command:	[:SENSE] :EVM:DLINK:PROFile:PDCCCh:ALLocation:SUBFrame2:SYMBOLs <integer> [:SENSE] :EVM:DLINK:PROFile:PDCCCh:ALLocation:SUBFrame2:SYMBOLs?
Example:	EVM:DLIN:PROF:PDCC:ALL:SUBF2:SYMB 1 EVM:DLIN:PROF:PDCC:ALL:SUBF2:SYMB?
Notes:	Changes to this parameter will not be applied until Update Changes command is sent. See “RB Parameter Manager (Downlink)” on page 915 section for more details.
Dependencies:	Available when both PDCCH Allocation Auto Detect and PDCCH Allocation Constant are OFF.
Preset:	3

LTE Modulation Analysis Measurement
Meas Setup (Measurement Setup)

State Saved:	Saved in instrument state.
Min:	0
Max:	3 – Bandwidth 3 MHz, 5 MHz, 10 MHz, 15 MHz, 20 MHz 4 – Bandwidth 1.4 MHz
Initial S/W Revision:	Prior to A.02.00
Modified at S/W Revision:	A.03.00
Help Map ID:	29119

PDCCH Allocation Subframe 3

Sets the PDCCH Allocation (Symbols per Subframe) for Subframe 3.

Key Path:	Meas Setup, Chan Profile Setup, Edit Control Channels
Mode:	LTE, LTETDD
Remote Command:	[:SENSe] :EVM:DLINk:PROFile:PDCCh:ALLocation:SUBFrame3:SYMBOLs <integer> [:SENSe] :EVM:DLINk:PROFile:PDCCh:ALLocation:SUBFrame3:SYMBOLs?
Example:	EVM:DLIN:PROF:PDCC:ALL:SUBF3:SYMB 1 EVM:DLIN:PROF:PDCC:ALL:SUBF3:SYMB?
Notes:	Changes to this parameter will not be applied until Update Changes command is sent. See “ RB Parameter Manager (Downlink) ” on page 915 section for more details.
Dependencies:	Available when both PDCCH Allocation Auto Detect and PDCCH Allocation Constant are OFF.
Preset:	3
State Saved:	Saved in instrument state.
Min:	0
Max:	3 – Bandwidth 3 MHz, 5 MHz, 10 MHz, 15 MHz, 20 MHz 4 – Bandwidth 1.4 MHz
Initial S/W Revision:	Prior to A.02.00
Modified at S/W Revision:	A.03.00
Help Map ID:	29120

PDCCH Allocation Subframe 4

Sets the PDCCH Allocation (Symbols per Subframe) for Subframe 4.

Key Path:	Meas Setup, Chan Profile Setup, Edit Control Channels
-----------	--

Mode:	LTE, LTETDD
Remote Command:	[:SENSE] :EVM:DLINK:PROFile:PDCCh:ALLocation:SUBFrame4:SYMBOLs <integer> [:SENSE] :EVM:DLINK:PROFile:PDCCh:ALLocation:SUBFrame4:SYMBOLs?
Example:	EVM:DLIN:PROF:PDCC:ALL:SUBF4:SYMB 1 EVM:DLIN:PROF:PDCC:ALL:SUBF4:SYMB?
Notes:	Changes to this parameter will not be applied until Update Changes command is sent. See “RB Parameter Manager (Downlink)” on page 915 section for more details.
Dependencies:	Available when both PDCCH Allocation Auto Detect and PDCCH Allocation Constant are OFF.
Preset:	3
State Saved:	Saved in instrument state.
Min:	0
Max:	3 – Bandwidth 3 MHz, 5 MHz, 10 MHz, 15 MHz, 20 MHz 4 – Bandwidth 1.4 MHz
Initial S/W Revision:	Prior to A.02.00
Modified at S/W Revision:	A.03.00
Help Map ID:	29121

PDCCH Allocation Subframe 5

Sets the PDCCH Allocation (Symbols per Subframe) for Subframe 5.

Key Path:	Meas Setup, Chan Profile Setup, Edit Control Channels
Mode:	LTE, LTETDD
Remote Command:	[:SENSE] :EVM:DLINK:PROFile:PDCCh:ALLocation:SUBFrame5:SYMBOLs <integer> [:SENSE] :EVM:DLINK:PROFile:PDCCh:ALLocation:SUBFrame5:SYMBOLs?
Example:	EVM:DLIN:PROF:PDCC:ALL:SUBF5:SYMB 1 EVM:DLIN:PROF:PDCC:ALL:SUBF5:SYMB?
Notes:	Changes to this parameter will not be applied until Update Changes command is sent. See “RB Parameter Manager (Downlink)” on page 915 section for more details.
Dependencies:	Available when both PDCCH Allocation Auto Detect and PDCCH Allocation Constant are OFF.

LTE Modulation Analysis Measurement
Meas Setup (Measurement Setup)

Preset:	3
State Saved:	Saved in instrument state.
Min:	0
Max:	3 – Bandwidth 3 MHz, 5 MHz, 10 MHz, 15 MHz, 20 MHz 4 – Bandwidth 1.4 MHz
Initial S/W Revision:	Prior to A.02.00
Modified at S/W Revision:	A.03.00
Help Map ID:	29122

PDCCH Allocation Subframe 6

Sets the PDCCH Allocation (Symbols per Subframe) for Subframe 6.

Key Path:	Meas Setup, Chan Profile Setup, Edit Control Channels
Mode:	LTE, LTETDD
Remote Command:	[:SENSe] :EVM:DLINk:PROFile:PDCCh:ALLocation:SUBFrame6:SYMBOLs <integer> [:SENSe] :EVM:DLINk:PROFile:PDCCh:ALLocation:SUBFrame6:SYMBOLs?
Example:	EVM:DLIN:PROF:PDCC:ALL:SUBF6:SYMB 1 EVM:DLIN:PROF:PDCC:ALL:SUBF6:SYMB?
Notes:	Changes to this parameter will not be applied until Update Changes command is sent. See “RB Parameter Manager (Downlink)” on page 915 section for more details.
Dependencies:	Available when both PDCCH Allocation Auto Detect and PDCCH Allocation Constant are OFF.
Preset:	3
State Saved:	Saved in instrument state.
Min:	0
Max:	3 – Bandwidth 3 MHz, 5 MHz, 10 MHz, 15 MHz, 20 MHz 4 – Bandwidth 1.4 MHz
Initial S/W Revision:	Prior to A.02.00
Modified at S/W Revision:	A.03.00
Help Map ID:	29123

PDCCH Allocation Subframe 7

Sets the PDCCH Allocation (Symbols per Subframe) for Subframe 7.

Key Path:	Meas Setup, Chan Profile Setup, Edit Control Channels
Mode:	LTE, LTETDD
Remote Command:	[:SENSe] :EVM:DLINk:PROFile:PDCCh:ALLocation:SUBFrame7:SYMBOLs <integer> [:SENSe] :EVM:DLINk:PROFile:PDCCh:ALLocation:SUBFrame7:SYMBOLs?
Example:	EVM:DLIN:PROF:PDCC:ALL:SUBF7:SYMB 1 EVM:DLIN:PROF:PDCC:ALL:SUBF7:SYMB?
Notes:	Changes to this parameter will not be applied until Update Changes command is sent. See “RB Parameter Manager (Downlink)” on page 915 section for more details.
Dependencies:	Available when both PDCCH Allocation Auto Detect and PDCCH Allocation Constant are OFF.
Preset:	3
State Saved:	Saved in instrument state.
Min:	0
Max:	3 – Bandwidth 3 MHz, 5 MHz, 10 MHz, 15 MHz, 20 MHz 4 – Bandwidth 1.4 MHz
Initial S/W Revision:	Prior to A.02.00
Modified at S/W Revision:	A.03.00
Help Map ID:	29124

PDCCH Allocation Subframe 8

Sets the PDCCH Allocation (Symbols per Subframe) for Subframe 8.

Key Path:	Meas Setup, Chan Profile Setup, Edit Control Channels
Mode:	LTE, LTETDD
Remote Command:	[:SENSe] :EVM:DLINk:PROFile:PDCCh:ALLocation:SUBFrame8:SYMBOLs <integer> [:SENSe] :EVM:DLINk:PROFile:PDCCh:ALLocation:SUBFrame8:SYMBOLs?
Example:	EVM:DLIN:PROF:PDCC:ALL:SUBF8:SYMB 1 EVM:DLIN:PROF:PDCC:ALL:SUBF8:SYMB?

LTE Modulation Analysis Measurement
Meas Setup (Measurement Setup)

Notes:	Changes to this parameter will not be applied until Update Changes command is sent. See “RB Parameter Manager (Downlink)” on page 915 section for more details.
Dependencies:	Available when both PDCCH Allocation Auto Detect and PDCCH Allocation Constant are OFF.
Preset:	3
State Saved:	Saved in instrument state.
Min:	0
Max:	3 – Bandwidth 3 MHz, 5 MHz, 10 MHz, 15 MHz, 20 MHz 4 – Bandwidth 1.4 MHz
Initial S/W Revision:	Prior to A.02.00
Modified at S/W Revision:	A.03.00
Help Map ID:	29125

PDCCH Allocation Subframe 9

Sets the PDCCH Allocation (Symbols per Subframe) for Subframe 9.

Key Path:	Meas Setup, Chan Profile Setup, Edit Control Channels
Mode:	LTE, LTETDD
Remote Command:	[:SENSe] :EVM:DLINK:PROFile:PDCh:ALLocation:SUBFrame9:SYMBOLs <integer> [:SENSe] :EVM:DLINK:PROFile:PDCh:ALLocation:SUBFrame9:SYMBOLs?
Example:	EVM:DLIN:PROF:PDCC:ALL:SUBF9:SYMB 1 EVM:DLIN:PROF:PDCC:ALL:SUBF9:SYMB?
Notes:	Changes to this parameter will not be applied until Update Changes command is sent. See “RB Parameter Manager (Downlink)” on page 915 section for more details.
Dependencies:	Available when both PDCCH Allocation Auto Detect and PDCCH Allocation Constant are OFF.
Preset:	3
State Saved:	Saved in instrument state.
Min:	0
Max:	3 – Bandwidth 3 MHz, 5 MHz, 10 MHz, 15 MHz, 20 MHz 4 – Bandwidth 1.4 MHz
Initial S/W Revision:	Prior to A.02.00
Modified at S/W Revision:	A.03.00

Help Map ID:	29126
--------------	-------

PHICH

Displays a menu that enables configuration of PHICH parameters.

Key Path:	Meas Setup, Chan Profile Setup, Edit Control Channels
Mode:	LTE, LTETDD
Initial S/W Revision:	Prior to A.02.00
Modified at S/W Revision:	A.03.00
Help Map ID:	30813

PHICH Power Boost

Sets the Power Boost value for the PHICH.

PHICH power boost specifies the BPSK symbol power of each PHICH sequence (unlike the Power Boost for the other channels, which are per-subcarrier). Since each PHICH sequence can potentially have a different BPSK symbol power, provision has been made to auto-detect it by specifying a starting value in this parameter and setting the granularity of the search in the PHICH Power Boost Step. The demodulator will detect each PHICH sequence's BPSK symbol power as

$$\text{PHICH power} = (\text{PHICH Power Boost} + k * \text{PHICH Power Boost Step})$$

where k in the range $-10 \text{ dB} \leq k * \text{PHICH Power Boost Step} \leq 10 \text{ dB}$ is the value that brings the equation closest to the actual PHICH BPSK symbol power. Note that setting the PHICH Power Boost Step to 0 dB effective turns off auto-detection of power.

Key Path:	Meas Setup, Chan Profile Setup, Edit Control Channels
Mode:	LTE, LTETDD
Remote Command:	[:SENSE] :EVM:DLINK:PROfile:PHICh:PWRBoost <rel_ampl> [:SENSE] :EVM:DLINK:PROfile:PHICh:PWRBoost?
Example:	EVM:DLIN:PROF:PHIC:PWRB 0 EVM:DLIN:PROF:PHIC:PWRB?
Notes:	Changes to this parameter will not be applied until Update Changes command is sent. See " RB Parameter Manager (Downlink) " on page 915 section for more details.
Preset:	0 dB
State Saved:	Saved in instrument state.
Min:	-100 dB
Max:	100 dB
Initial S/W Revision:	Prior to A.02.00
Modified at S/W Revision:	A.03.00

LTE Modulation Analysis Measurement
Meas Setup (Measurement Setup)

Modified at S/W Revision:	A.04.20
Help Map ID:	29183

PHICH Power Boost Step (+/- Increments (dB))

Sets the Power Boost Step value for the PHICH. See “[PHICH Power Boost](#)” on page 819 for details.

Key Path:	Meas Setup, Chan Profile Setup, Edit Control Channels
Mode:	LTE, LTETDD
Remote Command:	[:SENSe] :EVM:DLINk:PROFile:PHICH:PWRBoost:STEP <rel_ampl>+ [:SENSe] :EVM:DLINk:PROFile:PHICH:PWRBoost:STEP?
Example:	EVM:DLIN:PROF:PHIC:PWRB:STEP 0 EVM:DLIN:PROF:PHIC:PWRB:STEP?
Notes:	Changes to this parameter will not be applied until Update Changes command is sent. See “ RB Parameter Manager (Downlink) ” on page 915 section for more details.
Preset:	1 dB
State Saved:	Saved in instrument state.
Min:	-100 dB
Max:	100 dB
Initial S/W Revision:	A.03.00, A.04.20
Help Map ID:	40760

Despread IQ Orthogonal Sequence Index

Determines the state of Despread IQ Orthogonal Sequence Index.

When set to OFF, displays the PHICH constellation points as received. These points are the summation of all weighted PHICH sequences within the same PHICH group.

When set to ON, the traces to show PHICH constellation points after despreading. Despreading arbitrarily remaps the demodulated values of individual PHICH sequences onto the I and Q values of the subcarriers containing those sequences.

EVM measurements are always calculated from PHICH IQ points before despreading.

Each PHICH can take on values in the set $\{-1, 0, 1\}$ which is translated as {NACK, Inactive, ACK}.

PHICH mapping for Normal CP Length		
Subcarrier in a PHICH group	Re{Subcarrier x} value	Imag{Subcarrier x} value
Subcarrier 0	PHICH0	PHICH4

Subcarrier 1	PHICH1	PHICH5
Subcarrier 2	PHICH2	PHICH6
Subcarrier 3	PHICH3	PHICH7

PHICH mapping for Extended CP Length		
Subcarrier in a PHICH group	Re{Subcarrier x} value	Imag{Subcarrier x} value
Subcarrier 0	PHICH0	PHICH2
Subcarrier 1	PHICH1	PHICH3

Each PHICH subcarrier IQ point represents the values for the two PHICHs determined by the tables above. The image below provides a quick reference to the actual PHICH values for each constellation point in the form (I,Q).

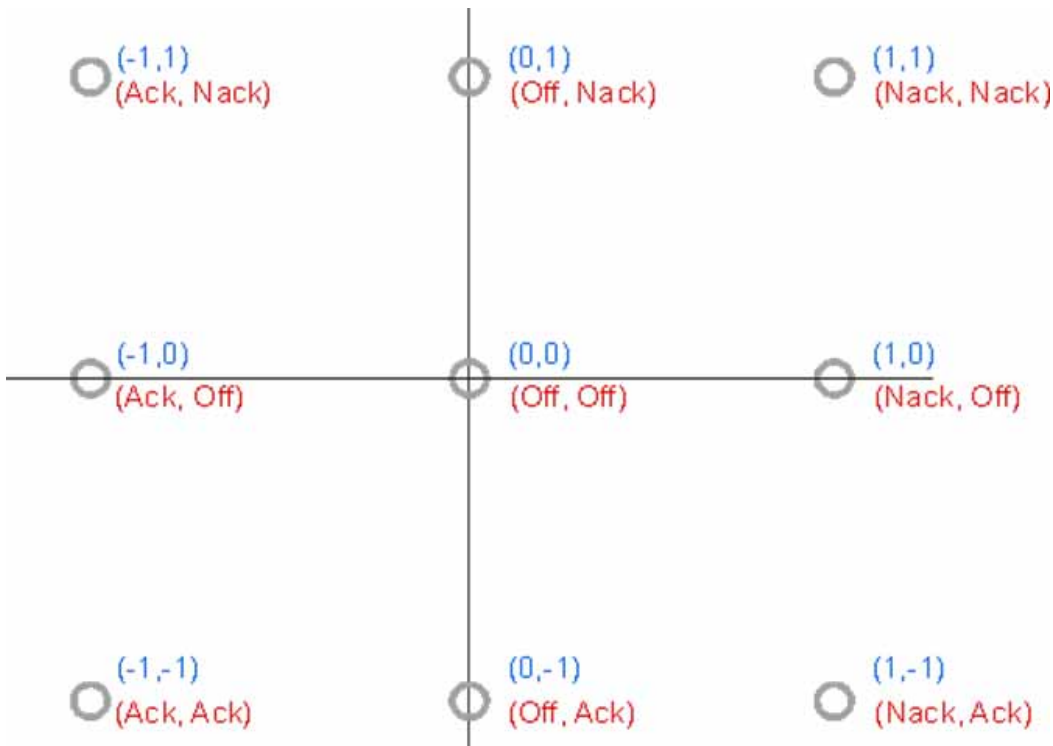

For example, the Subcarrier 1 IQ point in a PHICH group is at (1,0). For a signal with Normal PHICH duration, Subcarrier 1 contains the values for PHICH1 and PHICH5; therefore, PHICH1=Nack and PHICH5=Off.

Key Path:	Meas Setup, Chan Profile Setup, Edit Control Channels
Mode:	LTE, LTETDD
Remote Command:	[:SENSE] :EVM:DLINK:PROfile:PHICH:DESPread OFF ON 0 1 [:SENSE] :EVM:DLINK:PROfile:PHICH:DESPread?

LTE Modulation Analysis Measurement
Meas Setup (Measurement Setup)

Example:	EVM:DLIN:PROF:PHIC:DESP OFF EVM:DLIN:PROF:PHIC:DESP?
Notes:	Changes to this parameter will not be applied until Update Changes command is sent. See “ RB Parameter Manager (Downlink) ” on page 915 section for more details.
Preset:	OFF
State Saved:	Saved in instrument state.
Initial S/W Revision:	Prior to A.02.00
Modified at S/W Revision:	A.03.00
Help Map ID:	30758

PHICH Allocation (Ng)

Selects the Ng value used in computing the number of resource element groups. Allocation (Ng) is a higher layer parameter configured from the set (1/6, 1/2, 1, 2) that determines the number of PHICH groups per subframe.

- ADETECT - Allocation (Ng) will be detected from PBCH.
- R1BY6 - Ng = 1/6
- R1BY2 - Ng = 1/2
- R1 - Ng = 1
- R2 - Ng = 2

The number of PHICH groups in a subframe is given by the equation for $N_{\text{PHICH}}^{\text{group}}$ in Section 6.9 of 3GPP TS 36.211.

Key Path:	Meas Setup, Chan Profile Setup, Edit Control Channels
Mode:	LTE, LTETDD
Remote Command:	[:SENSE] :EVM:DLINK:PROFILE:PHICH:ALLOCATION:RATIO ADETECT R1BY6 R1BY2 R1 R2 [:SENSE] :EVM:DLINK:PROFILE:PHICH:ALLOCATION:RATIO?
Example:	EVM:DLIN:PROF:PHIC:ALL:RAT R1 EVM:DLIN:PROF:PHIC:ALL:RAT?
Notes:	Changes to this parameter will not be applied until Update Changes command is sent. See “ RB Parameter Manager (Downlink) ” on page 915 section for more details.
Dependencies:	Available when Direction is Downlink.
Preset:	ADETECT
State Saved:	Saved in instrument state.
Range:	Auto Detect Ng 1/6 Ng 1/2 Ng 1 Ng 2

Initial S/W Revision:	Prior to A.02.00
Modified at S/W Revision:	A.03.00, A.06.00
Help Map ID:	29187

Auto Detect

When Auto Detect is selected, Allocation (Ng) will be detected from PBCH.

Key Path:	Meas Setup, Chan Profile Setup, Edit Control Channels
Mode:	LTE, LTETDD
Initial S/W Revision:	A.06.00
Help Map ID:	29114

Ng 1/6

Selects 1/6 for the Ng value used in computing the number of resource element groups.

Key Path:	Meas Setup, Chan Profile Setup, Edit Control Channels
Mode:	LTE, LTETDD
Initial S/W Revision:	Prior to A.02.00
Modified at S/W Revision:	A.03.00
Help Map ID:	29188

Ng 1/2

Selects 1/2 for the Ng value used in computing the number of resource element groups.

Key Path:	Meas Setup, Chan Profile Setup, Edit Control Channels
Mode:	LTE, LTETDD
Initial S/W Revision:	Prior to A.02.00
Modified at S/W Revision:	A.03.00
Help Map ID:	29189

Ng 1

Selects 1 for the Ng value used in computing the number of resource element groups.

Key Path:	Meas Setup, Chan Profile Setup, Edit Control Channels
Mode:	LTE, LTETDD
Initial S/W Revision:	Prior to A.02.00
Modified at S/W Revision:	A.03.00

LTE Modulation Analysis Measurement
Meas Setup (Measurement Setup)

Help Map ID:	29190
--------------	-------

Ng 2

Selects 2 for the Ng value used in computing the number of resource element groups.

Key Path:	Meas Setup, Chan Profile Setup, Edit Control Channels
Mode:	LTE, LTETDD
Initial S/W Revision:	Prior to A.02.00
Modified at S/W Revision:	A.03.00
Help Map ID:	29191

PHICH Duration

Selects the number of symbols used in each PHICH subframe.

PHICH duration is a higher layer parameter configured either as Normal or Extended that tells the demodulator how many symbols per subframe are used by PHICH.

- ADETECT - PHICH Duration can be autodetected from PBCH
- NORMAl - There are 8 PHICH sequences in one PHICH group
- EXTended - There are 4 PHICH sequences in one PHICH group

Key Path:	Meas Setup, Chan Profile Setup, Edit Control Channels
Mode:	LTE, LTETDD
Remote Command:	[:SENSe] :EVM:DLINk:PROFile:PHICH:DURation ADETECT NORMAl EXTended [:SENSe] :EVM:DLINk:PROFile:PHICH:DURation?
Example:	EVM:DLIN:PROF:PHIC:DUR NORM EVM:DLIN:PROF:PHIC:DUR?
Notes:	Changes to this parameter will not be applied until Update Changes command is sent. See “RB Parameter Manager (Downlink)” on page 915 section for more details.
Dependencies:	Available when Direction is Downlink.
Preset:	ADETECT
State Saved:	Saved in instrument state.
Range:	Auto Detect Normal Extended
Initial S/W Revision:	Prior to A.02.00
Modified at S/W Revision:	A.03.00, A.06.00
Help Map ID:	29192

Auto Detect

When Auto Detect is selected, PHICH Duration can be autodetected from PBCH

Key Path:	Meas Setup, Chan Profile Setup, Edit Control Channels, PHICH Duration
Mode:	LTE, LTETDD
Initial S/W Revision:	A.06.00
Help Map ID:	29115

Normal

Selects Normal for the PHICH duration.

Key Path:	Meas Setup, Chan Profile Setup, Edit Control Channels, PHICH Duration
Mode:	LTE, LTETDD
Initial S/W Revision:	Prior to A.02.00
Modified at S/W Revision:	A.03.00
Help Map ID:	29193

Extended

Selects Extended for the PHICH duration.

Key Path:	Meas Setup, Chan Profile Setup, Edit Control Channels, PHICH Duration
Mode:	LTE, LTETDD
Initial S/W Revision:	Prior to A.02.00
Modified at S/W Revision:	A.03.00
Help Map ID:	29194

Mi Definition

Selects which specification the factor M_i is set to. The factor M_i is originally defined in 3GPP TS36.211 Table 6.9–1 and it is used to specify the number of PHICH groups which may vary between downlink subframes.

The M_i parameter determines how many PHICH groups are in each downlink subframe for TDD mode. The values for M_i depend on the uplink-downlink configuration and are given by Table 6.9–1 in 3GPP TS 36.211. However, 3GPP TS 36.141, section 6.1.2.6 specifies that M_i must be set to 1 when performing E-TM tests. This is to provide consistency between FDD and TDD test results.

- STD - Standard, the expected values of M_i are given by Table 6.9–1 in 3GPP TS36.211
- ETM - E-TM, M_i is expected to equal 1 in all downlink subframes

Key Path:	Meas Setup, Chan Profile Setup, Edit Control Channels
Mode:	LTETDD

LTE Modulation Analysis Measurement
Meas Setup (Measurement Setup)

Remote Command:	[:SENSe] :EVM:DLINk:PROFile:PHICh:MIDefinition STD ETM [:SENSe] :EVM:DLINk:PROFile:PHICh:MIDefinition?
Example:	EVM:DLIN:PROF:PHIC:MID STD
Notes:	LTE TDD only. Changes to this parameter will not be applied until Update Changes command is sent. See “RB Parameter Manager (Downlink)” on page 915 section for more details.
Dependencies:	Available when Direction is Downlink. LTE TDD only.
Preset:	STD
State Saved:	Saved in instrument state.
Range:	Standard E-TM
Initial S/W Revision:	A.06.00
Help Map ID:	29199

P- RS

Displays a menu that enables configuration of Positioning Reference Signals (P-RS) parameters.

P-RS parameters are transmitted on antenna port 6 at regularly spaced time and frequency locations. The measurement will provide support for analysis of P-RS transmitted on normal subframes. P-RS transmitted on MBSFN subframes will not be analyzed.

Key Path:	Meas Setup, Chan Profile Setup, Edit Control Channels
Mode:	LTE, LTETDD
Initial S/W Revision:	A.11.00
Help Map ID:	40907

P-RS Active

Selects whether or not the position reference signal exists in the input signal.

Key Path:	Meas Setup, Chan Profile Setup, Edit Control Channels
Mode:	LTE, LTETDD
Remote Command:	[:SENSe] :EVM:DLINk:PROFile:PRS:ACTive OFF ON 0 1 [:SENSe] :EVM:DLINk:PROFile:PRS:ACTive?
Example:	EVM:DLIN:PROF:PRS:ACT OFF EVM:DLIN:PROF:PRS:ACT?

Notes:	Changes to this parameter will not be applied until Update Changes command is sent. See “RB Parameter Manager (Downlink)” on page 915 section for more details.
Preset:	OFF
State Saved:	Saved in instrument state.
Range:	On Off
Initial S/W Revision:	A.11.00
Help Map ID:	40908

P-RS Bandwidth

Sets the Bandwidth of the position reference signal, its unit is RBs.

Key Path:	Meas Setup, Chan Profile Setup, Edit Control Channels
Mode:	LTE, LTETDD
Remote Command:	[:SENSE] :EVM:DLINK:PROfile:PRS:BANDwidth B1M4 B3M B5M B10M B15M B20M [:SENSE] :EVM:DLINK:PROfile:PRS:BANDwidth?
Example:	EVM:DLIN:PROF:PRS:BAND B10M EVM:DLIN:PROF:PRS:BAND?
Notes:	Changes to this parameter will not be applied until Update Changes command is sent. See “RB Parameter Manager (Downlink)” on page 915 section for more details.
Dependencies:	Available when P-RS Active is On. It is needed to set P-RS Active to On in advance. Otherwise, this key is grayed out.
Preset:	B5M
State Saved:	Saved in instrument state.
Range:	1.4 MHz (6 RB) 3 MHz (15 RB) 5 MHz (25 RB) 10 MHz (50 RB) 15 MHz (75 RB) 20 MHz (100 RB)
Initial S/W Revision:	A.11.00
Help Map ID:	40909

P-RS Power Boost

Sets the Power Boost value for the P-RS channel.

Key Path:	Meas Setup, Chan Profile Setup, Edit Control Channels
Mode:	LTE, LTETDD

LTE Modulation Analysis Measurement
Meas Setup (Measurement Setup)

Remote Command:	[:SENSE] :EVM:DLINK:PROFile:PRS:PWRBoost <rel_ampl> [:SENSE] :EVM:DLINK:PROFile:PRS:PWRBoost?
Example:	EVM:DLIN:PROF:PRS:PWRB 2.0 EVM:DLIN:PROF:PRS:PWRB?
Notes:	Changes to this parameter will not be applied until Update Changes command is sent. See “RB Parameter Manager (Downlink)” on page 915 section for more details.
Dependencies:	Available when P-RS Active is On, grayed out other wise.
Preset:	0.0 dB
State Saved:	Saved in instrument state.
Min:	-100 dB
Max:	100 dB
Initial S/W Revision:	A.11.00
Help Map ID:	40910

P-RS Config Index

Sets the configuration index of the position reference signal.

Key Path:	Meas Setup, Chan Profile Setup, Edit Control Channels
Mode:	LTE, LTETDD
Remote Command:	[:SENSE] :EVM:DLINK:PROFile:PRS:INDEX <integer> [:SENSE] :EVM:DLINK:PROFile:PRS:INDEX?
Example:	EVM:DLIN:PROF:PRS:IND 160 EVM:DLIN:PROF:PRS:IND?
Notes:	Changes to this parameter will not be applied until Update Changes command is sent. See “RB Parameter Manager (Downlink)” on page 915 section for more details.
Dependencies:	Available when P-RS Active is On. Otherwise, this key is grayed out.
Preset:	0
State Saved:	Saved in instrument state.
Min:	0
Max:	2399
Initial S/W Revision:	A.11.00
Help Map ID:	40911

NPRS

Sets the number of consecutive downlink subframes that the position reference signal shall be transmitted.

Key Path:	Meas Setup, Chan Profile Setup, Edit Control Channels
Mode:	LTE, LTETDD
Remote Command:	[:SENSe] :EVM:DLINk:PROFile:PRS:SUBFrame:NUMBer N1 N2 N4 N6 [:SENSe] :EVM:DLINk:PROFile:PRS:SUBFrame:NUMBer?
Example:	EVM:DLIN:PROF:PRS:SUBF:NUMB N6 EVM:DLIN:PROF:PRS:SUBF:NUMB?
Notes:	Changes to this parameter will not be applied until Update Changes command is sent. See “RB Parameter Manager (Downlink)” on page 915 section for more details. N1 means the consecutive downlink subframes number is 1. N2 means the consecutive downlink subframes number is 2. N4 means the consecutive downlink subframes number is 4. N6 means the consecutive downlink subframes number is 6.
Dependencies:	Available when P-RS Active is On. Otherwise, this key is grayed out.
Preset:	N1
State Saved:	Saved in instrument state.
Range:	N1 N2 N4 N6
Initial S/W Revision:	A.11.00
Help Map ID:	40912

MBSFN

Displays a menu that enables configuration of MBSFN parameters.

Key Path:	Meas Setup, Chan Profile Setup, Edit Control Channels
Mode:	LTE, LTETDD
Initial S/W Revision:	A.11.00
Help Map ID:	40913

MBSFN Active

Selects whether or not the MBSFN signal exists for this downlink user in the input signal.

Key Path:	Meas Setup, Chan Profile Setup, Edit Control Channels
Mode:	LTE, LTETDD

LTE Modulation Analysis Measurement
Meas Setup (Measurement Setup)

Remote Command:	[:SENSe] :EVM:DLINk:PROFile:MBSFn:ACTive OFF ON 0 1 [:SENSe] :EVM:DLINk:PROFile:MBSFn:ACTive?
Example:	EVM:DLIN:PROF:MBSF:ACT OFF EVM:DLIN:PROF:MBSF:ACT?
Notes:	Changes to this parameter will not be applied until Update Changes command is sent. See “RB Parameter Manager (Downlink)” on page 915 section for more details.
Preset:	OFF
State Saved:	Saved in instrument state.
Range:	On Off
Initial S/W Revision:	A.11.00
Help Map ID:	40914

MBSFN Area ID

Sets a value for Multimedia Broadcast Multicast Service Single Frequency Network Reference Signal (MBSFN) Area ID which identifies the MBSFN Area . It is used for the scrambling of the MBSFN Reference Signals and the Physical Multicast Channel (PMCH).

Key Path:	Meas Setup, Chan Profile Setup, Edit Control Channels
Mode:	LTE, LTETDD
Remote Command:	[:SENSe] :EVM:DLINk:PROFile:MBSFn:AID <integer> [:SENSe] :EVM:DLINk:PROFile:MBSFn:AID?
Example:	EVM:DLIN:PROF:MBSF:AID 1 EVM:DLIN:PROF:MBSF:AID?
Notes:	Changes to this parameter will not be applied until Update Changes command is sent. See “RB Parameter Manager (Downlink)” on page 915 section for more details.
Dependencies:	Available when MBSFN Active is On. Otherwise, this key is grayed out.
Preset:	0
State Saved:	Saved in instrument state.
Min:	0
Max:	255
Initial S/W Revision:	A.11.00
Help Map ID:	40915

Non-MBSFN Region Length

Sets a value for Non-MBSFN region’s symbol number.

A subset of the downlink subframes in a radio frame on a carrier supporting PDSCH transmission can be configured as MBSFN subframes by higher layers. Each MBSFN subframe is divided into a non-MBSFN region and an MBSFN region.

-The non-MBSFN region spans the first one or two OFDM symbols in an MBSFN. Transmission in the non-MBSFN region shall use the same cyclic prefix length as used for subframe 0.

-The MBSFN region in an MBSFN subframe is defined as the OFDM symbols not used for the non-MBSFN region.

Key Path:	Meas Setup, Chan Profile Setup, Edit Control Channels
Mode:	LTE, LTETDD
Remote Command:	[:SENSE] :EVM:DLINK:PROFile:MBSFn:NMRLength <integer> [:SENSE] :EVM:DLINK:PROFile:MBSFN:NMRLength?
Example:	EVM:DLIN:PROF:MBSF:NMRL 2 EVM:DLIN:PROF:MBSF:NMRL?
Notes:	Changes to this parameter will not be applied until Update Changes command is sent. See “RB Parameter Manager (Downlink)” on page 915 section for more details.
Dependencies:	Available when MBSFN Active is On, grayed out otherwise.
Preset:	1
State Saved:	Saved in instrument state.
Min:	1
Max:	2
Initial S/W Revision:	A.11.00
Help Map ID:	40916

MBSFN-RS Power Boost (dB)

Sets the Power Boost value for MBSFN-RS channel.

Key Path:	Meas Setup, Chan Profile Setup, Edit Control Channels
Mode:	LTE, LTETDD
Remote Command:	[:SENSE] :EVM:DLINK:PROFile:MBSFn:PWRBoost <rel_ampl> [:SENSE] :EVM:DLINK:PROFile:MBSFn:PWRBoost?
Example:	EVM:DLIN:PROF:MBSF:PWRB 10.0 EVM:DLIN:PROF:MBSF:PWRB?
Notes:	Changes to this parameter will not be applied until Update Changes command is sent. See “RB Parameter Manager (Downlink)” on page 915 section for more details.

LTE Modulation Analysis Measurement
Meas Setup (Measurement Setup)

Dependencies:	Available when MBSFN-RS Active is On. Otherwise, this key is grayed out.
Preset:	0.0 dB
State Saved:	Saved in instrument state.
Min:	-100 dB
Max:	100 dB
Initial S/W Revision:	A.11.00
Help Map ID:	40917

MBSFN Subframe1

The MBSFN subframe configuration defines subframes that are reserved for MBSFN in downlink.

Sets Subframe1 to be reserved for MBSFN in downlink when Detection is Manual.

Key Path:	Meas Setup, Chan Profile Setup, Edit Control Channels
Mode:	LTE
Remote Command:	[:SENSE] :EVM:DLINK:PROFile:MBSFN:SUBFrame1:ACTIVE OFF ON 0 1 [:SENSE] :EVM:DLINK:PROFile:MBSFN:SUBFrame1:ACTIVE?
Example:	EVM:DLIN:PROF:MBSF:SUBF1:ACT ON EVM:DLIN:PROF:MBSF:SUBF1:ACT?
Notes:	Changes to this parameter will not be applied until Update Changes command is sent. See “RB Parameter Manager (Downlink)” on page 915 section for more details.
Dependencies:	Available when the Mode is LTE. Available when MBSFN Active is On. Otherwise, this key is grayed out.
Preset:	OFF
State Saved:	Saved in instrument state.
Range:	On Off
Initial S/W Revision:	A.11.00
Help Map ID:	40918

MBSFN Subframe2

Sets Subframe2 to be reserved for MBSFN in downlink when Detection is Manual.

Key Path:	Meas Setup, Chan Profile Setup, Edit Control Channels
Mode:	LTE

Remote Command:	[:SENSE] :EVM:DLINK:PROFile:MBSFn:SUBFrame2:ACTive OFF ON 0 1 [:SENSE] :EVM:DLINK:PROFile:MBSFn:SUBFrame2:ACTive?
Example:	EVM:DLIN:PROF:MBSF:SUBF2:ACT ON EVM:DLIN:PROF:MBSF:SUBF2:ACT?
Notes:	Changes to this parameter will not be applied until Update Changes command is sent. See “RB Parameter Manager (Downlink)” on page 915 section for more details.
Dependencies:	Available when the Mode is LTE. Available when MBSFN Active is On. Otherwise, this key is grayed out.
Preset:	OFF
State Saved:	Saved in instrument state.
Range:	On Off
Initial S/W Revision:	A.11.00
Help Map ID:	40919

MBSFN Subframe3

Sets Subframe3 to be reserved for MBSFN in downlink when Detection is Manual.

Key Path:	Meas Setup, Chan Profile Setup, Edit Control Channels
Mode:	LTE, LTETDD
Remote Command:	[:SENSE] :EVM:DLINK:PROFile:MBSFn:SUBFrame3:ACTive OFF ON 0 1 [:SENSE] :EVM:DLINK:PROFile:MBSFn:SUBFrame3:ACTive?
Example:	EVM:DLIN:PROF:MBSF:SUBF3:ACT ON EVM:DLIN:PROF:MBSF:SUBF3:ACT?
Notes:	Changes to this parameter will not be applied until Update Changes command is sent. See “RB Parameter Manager (Downlink)” on page 915 section for more details.
Dependencies:	Available when MBSFN Active is On. Otherwise, this key is grayed out.
Preset:	OFF
State Saved:	Saved in instrument state.
Range:	On Off
Initial S/W Revision:	A.11.00
Help Map ID:	40920

LTE Modulation Analysis Measurement
Meas Setup (Measurement Setup)

MBSFN Subframe4

Sets Subframe4 to be reserved for MBSFN in downlink when Detection is Manual.

Key Path:	Meas Setup, Chan Profile Setup, Edit Control Channels
Mode:	LTETDD
Remote Command:	[:SENSe] :EVM:DLINk:PROFfile:MBSFN:SUBFrame4:ACTive OFF ON 0 1 [:SENSe] :EVM:DLINk:PROFfile:MBSFN:SUBFrame4:ACTive?
Example:	EVM:DLIN:PROF:MBSF:SUBF4:ACT ON EVM:DLIN:PROF:MBSF:SUBF4:ACT?
Notes:	Changes to this parameter will not be applied until Update Changes command is sent. See “RB Parameter Manager (Downlink)” on page 915 section for more details.
Dependencies:	Available when Mode is LTETDD. Available when MBSFN Active is On. Otherwise, this key is grayed out.
Preset:	OFF
State Saved:	Saved in instrument state.
Range:	On Off
Initial S/W Revision:	A.11.00
Help Map ID:	40921

MBSFN Subframe6

Sets Subframe6 to be reserved for MBSFN in downlink when Detection is Manual.

Key Path:	Meas Setup, Chan Profile Setup, Edit Control Channels
Mode:	LTE
Remote Command:	[:SENSe] :EVM:DLINk:PROFfile:MBSFN:SUBFrame6:ACTive OFF ON 0 1 [:SENSe] :EVM:DLINk:PROFfile:MBSFN:SUBFrame6:ACTive?
Example:	EVM:DLIN:PROF:MBSF:SUBF6:ACT ON EVM:DLIN:PROF:MBSF:SUBF6:ACT?
Notes:	Changes to this parameter will not be applied until Update Changes command is sent. See “RB Parameter Manager (Downlink)” on page 915 section for more details.
Dependencies:	Available when Mode is LTE. Available when MBSFN Active is On. Otherwise, this key is grayed out.
Preset:	OFF

State Saved:	Saved in instrument state.
Range:	On Off
Initial S/W Revision:	A.11.00
Help Map ID:	40922

MBSFN Subframe7

Sets Subframe7 to be reserved for MBSFN in downlink when Detection is Manual.

Key Path:	Meas Setup, Chan Profile Setup, Edit Control Channels
Mode:	LTE, LTETDD
Remote Command:	[:SENSE] :EVM:DLINK:PROFile:MBSFn:SUBFrame7:ACTive OFF ON 0 1 [:SENSE] :EVM:DLINK:PROFile:MBSFn:SUBFrame7:ACTive?
Example:	EVM:DLIN:PROF:MBSF:SUBF7:ACT ON EVM:DLIN:PROF:MBSF:SUBF7:ACT?
Notes:	Changes to this parameter will not be applied until Update Changes command is sent. See “RB Parameter Manager (Downlink)” on page 915 section for more details.
Dependencies:	Available when MBSFN Active is On. Otherwise, this key is grayed out.
Preset:	OFF
State Saved:	Saved in instrument state.
Range:	On Off
Initial S/W Revision:	A.11.00
Help Map ID:	40923

MBSFN Subframe8

Sets Subframe8 to be reserved for MBSFN in downlink when Detection is Manual.

Key Path:	Meas Setup, Chan Profile Setup, Edit Control Channels
Mode:	LTE, LTETDD
Remote Command:	[:SENSE] :EVM:DLINK:PROFile:MBSFn:SUBFrame8:ACTive OFF ON 0 1 [:SENSE] :EVM:DLINK:PROFile:MBSFn:SUBFrame8:ACTive?
Example:	EVM:DLIN:PROF:MBSF:SUBF8:ACT ON EVM:DLIN:PROF:MBSF:SUBF8:ACT?

LTE Modulation Analysis Measurement
Meas Setup (Measurement Setup)

Notes:	Changes to this parameter will not be applied until Update Changes command is sent. See “RB Parameter Manager (Downlink)” on page 915 section for more details.
Dependencies:	Available when MBSFN Active is On. Otherwise, this key is grayed out.
Preset:	OFF
State Saved:	Saved in instrument state.
Range:	On Off
Initial S/W Revision:	A.11.00
Help Map ID:	40924

MBSFN Subframe9

Sets Subframe9 to be reserved for MBSFN in downlink when Detection is Manual.

Key Path:	Meas Setup, Chan Profile Setup, Edit Control Channels
Mode:	LTETDD
Remote Command:	[:SENSe] :EVM:DLINk:PROFile:MBSFN:SUBFrame9:ACTive OFF ON 0 1 [:SENSe] :EVM:DLINk:PROFile:MBSFN:SUBFrame9:ACTive?
Example:	EVM:DLIN:PROF:MBSF:SUBF9:ACT ON EVM:DLIN:PROF:MBSF:SUBF9:ACT?
Notes:	Changes to this parameter will not be applied until Update Changes command is sent. See “RB Parameter Manager (Downlink)” on page 915 section for more details.
Dependencies:	Available when Mode is LTETDD. Available when MBSFN Active is On. Otherwise, this key is grayed out.
Preset:	OFF
State Saved:	Saved in instrument state.
Range:	On Off
Initial S/W Revision:	A.11.00
Help Map ID:	40925

PMCH

Displays a menu that enables configuration of PMCH parameters.

Key Path:	Meas Setup, Chan Profile Setup, Edit Control Channels
Mode:	LTE, LTETDD

Initial S/W Revision:	A.11.00
Help Map ID:	40926

Auto Detect PMCH Power Boost

Sets the Power Boost value for the PMCH Channel when Detection is Auto.

Key Path:	Meas Setup, Chan Profile Setup, Edit Control Channels
Mode:	LTE, LTETDD
Remote Command:	[:SENSE] :EVM:DLINK:PROFile:AUTO:PMCH:PWRBoost <rel_ampl> [:SENSE] :EVM:DLINK:PROFile:AUTO:PMCH:PWRBoost?
Example:	EVM:DLIN:PROF:AUTO:PMCH:PWRB 3.0 EVM:DLIN:PROF:AUTO:PMCH:PWRB?
Notes:	Changes to this parameter will not be applied until Update Changes command is sent. See “RB Parameter Manager (Downlink)” on page 915 section for more details.
Dependencies:	Available when Detection is Auto and when MBSFN-RS Active is On. Otherwise, this key is grayed out.
Preset:	0.0 dB
State Saved:	Saved in instrument state.
Min:	-100 dB
Max:	100 dB
Initial S/W Revision:	A.11.00
Help Map ID:	40927

PMCH Active

Describes if PMCH channel presents in Subframe1~Subframe9.

Key Path:	Meas Setup, Chan Profile Setup, Edit Control Channels
Initial S/W Revision:	A.11.00
Help Map ID:	40928

PMCH Subframe1 Active

Sets weather or not PMCH channel presents in Subframe1 when Detection is Manual.

Key Path:	Meas Setup, Chan Profile Setup, Edit Control Channels
Mode:	LTE

LTE Modulation Analysis Measurement
Meas Setup (Measurement Setup)

Remote Command:	[:SENSe] :EVM:DLINk:PROFile:PMCH:SUBFrame1:ACTive OFF ON 0 1 [:SENSe] :EVM:DLINk:PROFile:PMCH:SUBFrame1:ACTive?
Example:	EVM:DLIN:PROF:PMCH:SUBF1:ACT ON EVM:DLIN:PROF:PMCH:SUBF1:ACT?
Notes:	Changes to this parameter will not be applied until Update Changes command is sent. See “RB Parameter Manager (Downlink)” on page 915 section for more details.
Dependencies:	Available when Mode is LTE. Available when MBSFN Active is On and MBSFN Subframe1 is On. Otherwise, this key is grayed out.
Preset:	OFF
State Saved:	Saved in instrument state.
Range:	On Off
Initial S/W Revision:	A.11.00
Help Map ID:	40929

PMCH Subframe2 Active

Sets whether or not PMCH channel presents in Subframe2 when Detection is Manual.

Key Path:	Meas Setup, Chan Profile Setup, Edit Control Channels
Mode:	LTE
Remote Command:	[:SENSe] :EVM:DLINk:PROFile:PMCH:SUBFrame2:ACTive OFF ON 0 1 [:SENSe] :EVM:DLINk:PROFile:PMCH:SUBFrame2:ACTive?
Example:	EVM:DLIN:PROF:PMCH:SUBF2:ACT ON EVM:DLIN:PROF:PMCH:SUBF2:ACT?
Notes:	Changes to this parameter will not be applied until Update Changes command is sent. See “RB Parameter Manager (Downlink)” on page 915 section for more details.
Dependencies:	Available when Mode is LTE. Available when MBSFN Active is On and MBSFN Subframe2 is On. Otherwise, this key is grayed out.
Preset:	OFF
State Saved:	Saved in instrument state.
Range:	On Off

Initial S/W Revision:	A.11.00
Help Map ID:	40930

PMCH Subframe3 Active

Sets whether or not PMCH channel presents in Subframe3 when Detection is Manual.

Key Path:	Meas Setup, Chan Profile Setup, Edit Control Channels
Mode:	LTE, LTETDD
Remote Command:	[:SENSE] :EVM:DLINK:PROFile:PMCH:SUBFrame3:ACTive OFF ON 0 1 [:SENSE] :EVM:DLINK:PROFile:PMCH:SUBFrame3:ACTive?
Example:	EVM:DLIN:PROF:PMCH:SUBF3:ACT ON EVM:DLIN:PROF:PMCH:SUBF3:ACT?
Notes:	Changes to this parameter will not be applied until Update Changes command is sent. See “RB Parameter Manager (Downlink)” on page 915 section for more details.
Dependencies:	Available when MBSFN Active is On and MBSFN Subframe3 is On. Otherwise, this key is grayed out.
Preset:	OFF
State Saved:	Saved in instrument state.
Range:	On Off
Initial S/W Revision:	A.11.00
Help Map ID:	40931

PMCH Subframe4 Active

Sets whether or not PMCH channel presents in Subframe4 when Detection is Manual.

Key Path:	Meas Setup, Chan Profile Setup, Edit Control Channels
Mode:	LTETDD
Remote Command:	[:SENSE] :EVM:DLINK:PROFile:PMCH:SUBFrame4:ACTive OFF ON 0 1 [:SENSE] :EVM:DLINK:PROFile:PMCH:SUBFrame4:ACTive?
Example:	EVM:DLIN:PROF:PMCH:SUBF4:ACT ON EVM:DLIN:PROF:PMCH:SUBF4:ACT?
Notes:	Changes to this parameter will not be applied until Update Changes command is sent. See “RB Parameter Manager (Downlink)” on page 915 section for more details.

LTE Modulation Analysis Measurement
Meas Setup (Measurement Setup)

Dependencies:	Available when mode is LTETDD. Available when MBSFN Active is On and MBSFN Subframe4 is On. Otherwise, this key is grayed out.
Preset:	OFF
State Saved:	Saved in instrument state.
Range:	On Off
Initial S/W Revision:	A.11.00
Help Map ID:	40932

PMCH Subframe6 Active

Sets weather or not PMCH channel presents in Subframe6 when Detection is Manual.

Key Path:	Meas Setup, Chan Profile Setup, Edit Control Channels
Mode:	LTE
Remote Command:	[:SENSE] :EVM:DLINK:PROF:PMCH:SUBFrame6:ACTIVE OFF ON 0 1 [:SENSE] :EVM:DLINK:PROF:PMCH:SUBFrame6:ACTIVE?
Example:	EVM:DLIN:PROF:PMCH:SUBF6:ACT ON EVM:DLIN:PROF:PMCH:SUBF6:ACT?
Notes:	Changes to this parameter will not be applied until Update Changes command is sent. See “RB Parameter Manager (Downlink)” on page 915 section for more details.
Dependencies:	Available when Mode is LTE. Available when MBSFN Active is On and MBSFN Subframe6 is On. Otherwise, this key is grayed out.
Preset:	OFF
State Saved:	Saved in instrument state.
Range:	On Off
Initial S/W Revision:	A.11.00
Help Map ID:	40933

PMCH Subframe7 Active

Sets weather or not PMCH channel presents in Subframe7 when Detection is Manual.

Key Path:	Meas Setup, Chan Profile Setup, Edit Control Channels
Mode:	LTE, LTETDD

Remote Command:	[:SENSe] :EVM:DLINk:PROFile:PMCH:SUBFrame7:ACTive OFF ON 0 1 [:SENSe] :EVM:DLINk:PROFile:PMCH:SUBFrame7:ACTive?
Example:	EVM:DLIN:PROF:PMCH:SUBF7:ACT ON EVM:DLIN:PROF:PMCH:SUBF7:ACT?
Notes:	Changes to this parameter will not be applied until Update Changes command is sent. See “RB Parameter Manager (Downlink)” on page 915 section for more details.
Dependencies:	Available when MBSFN Active is On and MBSFN Subframe7 is On. Otherwise, this key is grayed out.
Preset:	OFF
State Saved:	Saved in instrument state.
Range:	On Off
Initial S/W Revision:	A.11.00
Help Map ID:	40934

PMCH Subframe8 Active

Sets weather or not PMCH channel presents in Subframe8 when Detection is Manual.

Key Path:	Meas Setup, Chan Profile Setup, Edit Control Channels
Mode:	LTE, LTETDD
Remote Command:	[:SENSe] :EVM:DLINk:PROFile:PMCH:SUBFrame8:ACTive OFF ON 0 1 [:SENSe] :EVM:DLINk:PROFile:PMCH:SUBFrame8:ACTive?
Example:	EVM:DLIN:PROF:PMCH:SUBF8:ACT ON EVM:DLIN:PROF:PMCH:SUBF8:ACT?
Notes:	Changes to this parameter will not be applied until Update Changes command is sent. See “RB Parameter Manager (Downlink)” on page 915 section for more details.
Dependencies:	Available when MBSFN Active is On and MBSFN Subframe8 is On. Otherwise, this key is grayed out.
Preset:	OFF
State Saved:	Saved in instrument state.
Range:	On Off
Initial S/W Revision:	A.11.00
Help Map ID:	40935

LTE Modulation Analysis Measurement
Meas Setup (Measurement Setup)

PMCH Subframe9 Active

Sets whether or not PMCH channel presents in Subframe9 when Detection is Manual.

Key Path:	Meas Setup, Chan Profile Setup, Edit Control Channels
Mode:	LTETDD
Remote Command:	[:SENSe] :EVM:DLINk:PROFile:PMCH:SUBFrame9:ACTive OFF ON 0 1 [:SENSe] :EVM:DLINk:PROFile:PMCH:SUBFrame9:ACTive?
Example:	EVM:DLIN:PROF:PMCH:SUBF9:ACT ON EVM:DLIN:PROF:PMCH:SUBF9:ACT?
Notes:	Changes to this parameter will not be applied until Update Changes command is sent. See “RB Parameter Manager (Downlink)” on page 915 section for more details.
Dependencies:	Available when mode is LTETDD. Available when MBSFN Active is On and MBSFN Subframe9 is On. Otherwise, this key is grayed out.
Preset:	OFF
State Saved:	Saved in instrument state.
Range:	On Off
Initial S/W Revision:	A.11.00
Help Map ID:	40936

PMCH Power Boost

Sets PMCH’s Power Boost for Subframe 1 ~ 9.

Key Path:	Meas Setup, Chan Profile Setup, Edit Control Channels
Initial S/W Revision:	A.11.00
Help Map ID:	40937

PMCH Subframe1 Power Boost

Sets PMCH’s Power Boost for Subframe1 when Detection is Manual.

Key Path:	Meas Setup, Chan Profile Setup, Edit Control Channels
Mode:	LTE
Remote Command:	[:SENSe] :EVM:DLINk:PROFile:PMCH:SUBFrame1:PWRBoost <rel_ampl> [:SENSe] :EVM:DLINk:PROFile:PMCH:SUBFrame1:PWRBoost?

Example:	EVM:DLIN:PROF:PMCH:SUBF1:PWRB 6.0 EVM:DLIN:PROF:PMCH:SUBF1:PWRB?
Notes:	Changes to this parameter will not be applied until Update Changes command is sent. See “RB Parameter Manager (Downlink)” on page 915 section for more details.
Dependencies:	Available when Mode is LTE. Available when MBSFN Active is On , MBSFN Subframe1 is On and PMCH Subframe1 is On. Otherwise, this key is grayed out.
Preset:	0.0 dB
State Saved:	Saved in instrument state.
Min:	-100 dB
Max:	100 dB
Initial S/W Revision:	A.11.00
Help Map ID:	40938

PMCH Subframe2 Power Boost

Sets PMCH’s Power Boost for Subframe2 when Detection is Manual.

Key Path:	Meas Setup, Chan Profile Setup, Edit Control Channels
Mode:	LTE
Remote Command:	[:SENSE] :EVM:DLINK:PROfile:PMCH:SUBFrame2:PWRBoost <rel_ampl> [:SENSE] :EVM:DLINK:PROfile:PMCH:SUBFrame2:PWRBoost?
Example:	EVM:DLIN:PROF:PMCH:SUBF2:PWRB 6.0 EVM:DLIN:PROF:PMCH:SUBF2:PWRB?
Notes:	Changes to this parameter will not be applied until Update Changes command is sent. See “RB Parameter Manager (Downlink)” on page 915 section for more details.
Dependencies:	Available when Mode is LTE. Available when MBSFN Active is On , MBSFN Subframe2 is On and PMCH Subframe2 is On. Otherwise, this key is grayed out.
Preset:	0.0 dB
State Saved:	Saved in instrument state.
Min:	-100 dB
Max:	100 dB
Initial S/W Revision:	A.11.00

Help Map ID:	40939
--------------	-------

PMCH Subframe3 Power Boost

Sets PMCH's Power Boost for Subframe3 when Detection is Manual.

Key Path:	Meas Setup, Chan Profile Setup, Edit Control Channels
Mode:	LTE, LTETDD
Remote Command:	[:SENSe] :EVM:DLINk:PROFile:PMCH:SUBFrame3:PWRBoost <rel_ampl> [:SENSe] :EVM:DLINk:PROFile:PMCH:SUBFrame3:PWRBoost?
Example:	EVM:DLIN:PROF:PMCH:SUBF3:PWRB 6.0 EVM:DLIN:PROF:PMCH:SUBF3:PWRB?
Notes:	Changes to this parameter will not be applied until Update Changes command is sent. See “RB Parameter Manager (Downlink)” on page 915 section for more details.
Dependencies:	Available when MBSFN Active is On , MBSFN Subframe3 is On and PMCH Subframe3 is On. Otherwise, this key is grayed out.
Preset:	0.0 dB
State Saved:	Saved in instrument state.
Min:	-100 dB
Max:	100 dB
Initial S/W Revision:	A.11.00

Help Map ID:	40940
--------------	-------

PMCH Subframe4 Power Boost

Sets PMCH's Power Boost for Subframe4 when Detection is Manual.

Key Path:	Meas Setup, Chan Profile Setup, Edit Control Channels
Mode:	LTETDD
Remote Command:	[:SENSe] :EVM:DLINk:PROFile:PMCH:SUBFrame4:PWRBoost <rel_ampl> [:SENSe] :EVM:DLINk:PROFile:PMCH:SUBFrame4:PWRBoost?
Example:	EVM:DLIN:PROF:PMCH:SUBF4:PWRB 6.0 EVM:DLIN:PROF:PMCH:SUBF4:PWRB?
Notes:	Changes to this parameter will not be applied until Update Changes command is sent. See “RB Parameter Manager (Downlink)” on page 915 section for more details.

Dependencies:	Available when Mode is LTETDD. Available when MBSFN Active is On , MBSFN Subframe4 is On and PMCH Subframe4 is On. Otherwise, this key is grayed out.
Preset:	0.0 dB
State Saved:	Saved in instrument state.
Min:	-100 dB
Max:	100 dB
Initial S/W Revision:	A.11.00
Help Map ID:	40941

PMCH Subframe6 Power Boost

Sets PMCH's Power Boost for Subframe6 when Detection is Manual.

Key Path:	Meas Setup, Chan Profile Setup, Edit Control Channels
Mode:	LTE
Remote Command:	[:SENSe] :EVM:DLINk:PROFile:PMCH:SUBFrame6:PWRBoost <rel_ampl> [:SENSe] :EVM:DLINk:PROFile:PMCH:SUBFrame6:PWRBoost?
Example:	EVM:DLIN:PROF:PMCH:SUBF6:PWRB 6.0 EVM:DLIN:PROF:PMCH:SUBF6:PWRB?
Notes:	Changes to this parameter will not be applied until Update Changes command is sent. See “RB Parameter Manager (Downlink)” on page 915 section for more details.
Dependencies:	Available when Mode is LTE. Available when MBSFN Active is On , MBSFN Subframe6 is On and PMCH Subframe6 is On. Otherwise, this key is grayed out.
Preset:	0.0 dB
State Saved:	Saved in instrument state.
Min:	-100 dB
Max:	100 dB
Initial S/W Revision:	A.11.00
Help Map ID:	40942

PMCH Subframe7 Power Boost

Sets PMCH's Power Boost for Subframe7 when Detection is Manual.

Key Path:	Meas Setup, Chan Profile Setup, Edit Control Channels
-----------	--

LTE Modulation Analysis Measurement
Meas Setup (Measurement Setup)

Mode:	LTE, LTETDD
Remote Command:	[:SENSe] :EVM:DLINK:PROFile:PMCH:SUBFrame7:PWRBoost <rel_ampl> [:SENSe] :EVM:DLINK:PROFile:PMCH:SUBFrame7:PWRBoost?
Example:	EVM:DLIN:PROF:PMCH:SUBF7:PWRB 6.0 EVM:DLIN:PROF:PMCH:SUBF7:PWRB?
Notes:	Changes to this parameter will not be applied until Update Changes command is sent. See “RB Parameter Manager (Downlink)” on page 915 section for more details.
Dependencies:	Available when MBSFN Active is On , MBSFN Subframe7 is On and PMCH Subframe7 is On. Otherwise, this key is grayed out.
Preset:	0.0 dB
State Saved:	Saved in instrument state.
Min:	-100 dB
Max:	100 dB
Initial S/W Revision:	A.11.00
Help Map ID:	40943

PMCH Subframe8 Power Boost

Sets PMCH’s Power Boost for Subframe8 when Detection is Manual.

Key Path:	Meas Setup, Chan Profile Setup, Edit Control Channels
Mode:	LTE, LTETDD
Remote Command:	[:SENSe] :EVM:DLINK:PROFile:PMCH:SUBFrame8:PWRBoost <rel_ampl> [:SENSe] :EVM:DLINK:PROFile:PMCH:SUBFrame8:PWRBoost?
Example:	EVM:DLIN:PROF:PMCH:SUBF8:PWRB 6.0 EVM:DLIN:PROF:PMCH:SUBF8:PWRB?
Notes:	Changes to this parameter will not be applied until Update Changes command is sent. See “RB Parameter Manager (Downlink)” on page 915 section for more details.
Dependencies:	Available when MBSFN Active is On , MBSFN Subframe8 is On and PMCH Subframe8 is On. Otherwise, this key is grayed out.
Preset:	0.0 dB
State Saved:	Saved in instrument state.
Min:	-100 dB
Max:	100 dB

Initial S/W Revision:	A.11.00
Help Map ID:	40944

PMCH Subframe9 Power Boost

Sets PMCH's Power Boost for Subframe9 when Detection is Manual.

Key Path:	Meas Setup, Chan Profile Setup, Edit Control Channels
Mode:	LTETDD
Remote Command:	[:SENSE] :EVM:DLINK:PROFile:PMCH:SUBFrame9:PWRBoost <rel_ampl> [:SENSE] :EVM:DLINK:PROFile:PMCH:SUBFrame9:PWRBoost?
Example:	EVM:DLIN:PROF:PMCH:SUBF9:PWRB 6.0 EVM:DLIN:PROF:PMCH:SUBF9:PWRB?
Notes:	Changes to this parameter will not be applied until Update Changes command is sent. See “RB Parameter Manager (Downlink)” on page 915 section for more details.
Dependencies:	Available when Mode is LTETDD. Available when MBSFN Active is On , MBSFN Subframe9 is On and PMCH Subframe9 is On. Otherwise, this key is grayed out.
Preset:	0.0 dB
State Saved:	Saved in instrument state.
Min:	-100 dB
Max:	100 dB
Initial S/W Revision:	A.11.00
Help Map ID:	40945

PMCH Mod Type

Selects PMCH channel's Modulation Type for Subframe 1 ~9.

Key Path:	Meas Setup, Chan Profile Setup, Edit Control Channels, PMCH
Initial S/W Revision:	A.11.00
Help Map ID:	40946

PMCH Subframe1 Mod Type

Selects PMCH channel's Modulation Type for Subframe1 when Detection is Manual.

Key Path:	Meas Setup, Chan Profile Setup, Edit Control Channels
Mode:	LTE

LTE Modulation Analysis Measurement
Meas Setup (Measurement Setup)

Remote Command:	[:SENSE] :EVM:DLINK:PROF:PMCH:SUBFrame1:MODulation:TYPE QPSK QAM16 QAM64 [:SENSE] :EVM:DLINK:PROF:PMCH:SUBFrame1:MODulation:TYPE?
Example:	EVM:DLIN:PROF:PMCH:SUBF1:MOD:TYPE QAM16 EVM:DLIN:PROF:PMCH:SUBF1:MOD:TYPE?
Notes:	Changes to this parameter will not be applied until Update Changes command is sent. See “RB Parameter Manager (Downlink)” on page 915 section for more details.
Dependencies:	Available when Mode is LTE. Available when MBSFN Active is On , MBSFN Subframe1 is On and PMCH Subframe1 is On. Otherwise, this key is grayed out.
Preset:	QPSK
State Saved:	Saved in instrument state.
Range:	QPSK 16QAM 64QAM
Initial S/W Revision:	A.11.00
Help Map ID:	40947

PMCH Subframe2 Mod Type

Selects PMCH channel’s Modulation Type for Subframe2 when Detection is Manual.

Key Path:	Meas Setup, Chan Profile Setup, Edit Control Channels
Mode:	LTE
Remote Command:	[:SENSE] :EVM:DLINK:PROF:PMCH:SUBFrame2:MODulation:TYPE QPSK QAM16 QAM64 [:SENSE] :EVM:DLINK:PROF:PMCH:SUBFrame2:MODulation:TYPE?
Example:	EVM:DLIN:PROF:PMCH:SUBF2:MOD:TYPE QAM16 EVM:DLIN:PROF:PMCH:SUBF2:MOD:TYPE?
Notes:	Changes to this parameter will not be applied until Update Changes command is sent. See “RB Parameter Manager (Downlink)” on page 915 section for more details.
Dependencies:	Available when Mode is LTE. Available when MBSFN Active is On , MBSFN Subframe2 is On and PMCH Subframe2 is On. Otherwise, this key is grayed out.
Preset:	QPSK
State Saved:	Saved in instrument state.
Range:	QPSK 16QAM 64QAM

Initial S/W Revision:	A.11.00
Help Map ID:	40948

PMCH Subframe3 Mod Type

Selects PMCH channel's Modulation Type for Subframe3 when Detection is Manual.

Key Path:	Meas Setup, Chan Profile Setup, Edit Control Channels
Mode:	LTE, LTETDD
Remote Command:	[:SENSE] :EVM:DLINK:PROFile:PMCH:SUBFrame3:MODulation:TYPE QPSK QAM16 QAM64 [:SENSE] :EVM:DLINK:PROFile:PMCH:SUBFrame3:MODulation:TYPE?
Example:	EVM:DLIN:PROF:PMCH:SUBF3:MOD:TYPE QAM16 EVM:DLIN:PROF:PMCH:SUBF3:MOD:TYPE?
Notes:	Changes to this parameter will not be applied until Update Changes command is sent. See “RB Parameter Manager (Downlink)” on page 915 section for more details.
Dependencies:	Available when MBSFN Active is On , MBSFN Subframe3 is On and PMCH Subframe3 is On. Otherwise, this key is grayed out.
Preset:	QPSK
State Saved:	Saved in instrument state.
Range:	QPSK 16QAM 64QAM
Initial S/W Revision:	A.11.00
Help Map ID:	40949

PMCH Subframe4 Mod Type

Selects PMCH channel's Modulation Type for Subframe4 when Detection is Manual.

Key Path:	Meas Setup, Chan Profile Setup, Edit Control Channels
Mode:	LTETDD
Remote Command:	[:SENSE] :EVM:DLINK:PROFile:PMCH:SUBFrame4:MODulation:TYPE QPSK QAM16 QAM64 [:SENSE] :EVM:DLINK:PROFile:PMCH:SUBFrame4:MODulation:TYPE?
Example:	EVM:DLIN:PROF:PMCH:SUBF4:MOD:TYPE QAM16 EVM:DLIN:PROF:PMCH:SUBF4:MOD:TYPE?

LTE Modulation Analysis Measurement
Meas Setup (Measurement Setup)

Notes:	Changes to this parameter will not be applied until Update Changes command is sent. See “ RB Parameter Manager (Downlink) ” on page 915 section for more details.
Dependencies:	Available when Mode is LTETDD. Available when MBSFN Active is On , MBSFN Subframe4 is On and PMCH Subframe4 is On. Otherwise, this key is grayed out.
Preset:	QPSK
State Saved:	Saved in instrument state.
Range:	QPSK 16QAM 64QAM
Initial S/W Revision:	A.11.00
Help Map ID:	40950

PMCH Subframe6 Mod Type

Selects PMCH channel’s Modulation Type for Subframe6 when Detection is Manual.

Key Path:	Meas Setup, Chan Profile Setup, Edit Control Channels
Mode:	LTE
Remote Command:	[:SENSE] :EVM:DLINk:PROFile:PMCH:SUBFrame6:MODulation:TY PE QPSK QAM16 QAM64 [:SENSE] :EVM:DLINk:PROFile:PMCH:SUBFrame6:MODulation:TY PE?
Example:	EVM:DLIN:PROF:PMCH:SUBF6:MOD:TYPE QAM16 EVM:DLIN:PROF:PMCH:SUBF6:MOD:TYPE?
Notes:	Changes to this parameter will not be applied until Update Changes command is sent. See “ RB Parameter Manager (Downlink) ” on page 915 section for more details.
Dependencies:	Available when Mode is LTE. Available when MBSFN Active is On , MBSFN Subframe6 is On and PMCH Subframe6 is On. Otherwise, this key is grayed out.
Preset:	QPSK
State Saved:	Saved in instrument state.
Range:	QPSK 16QAM 64QAM
Initial S/W Revision:	A.11.00
Help Map ID:	40951

PMCH Subframe7 Mod Type

Selects PMCH channel's Modulation Type for Subframe7 when Detection is Manual.

Key Path:	Meas Setup, Chan Profile Setup, Edit Control Channels
Mode:	LTE, LTETDD
Remote Command:	[:SENSE] :EVM:DLINk:PROFile:PMCH:SUBFrame7:MODulation:TY PE QPSK QAM16 QAM64 [:SENSE] :EVM:DLINk:PROFile:PMCH:SUBFrame7:MODulation:TY PE?
Example:	EVM:DLIN:PROF:PMCH:SUBF7:MOD:TYPE QAM16 EVM:DLIN:PROF:PMCH:SUBF7:MOD:TYPE?
Notes:	Changes to this parameter will not be applied until Update Changes command is sent. See “RB Parameter Manager (Downlink)” on page 915 section for more details.
Dependencies:	Available when MBSFN Active is On , MBSFN Subframe7 is On and PMCH Subframe7 is On. Otherwise, this key is grayed out.
Preset:	QPSK
State Saved:	Saved in instrument state.
Range:	QPSK 16QAM 64QAM
Initial S/W Revision:	A.11.00
Help Map ID:	40952

PMCH Subframe8 Mod Type

Selects PMCH channel's Modulation Type for Subframe8 when Detection is Manual.

Key Path:	Meas Setup, Chan Profile Setup, Edit Control Channels
Mode:	LTE, LTETDD
Remote Command:	[:SENSE] :EVM:DLINk:PROFile:PMCH:SUBFrame8:MODulation:TY PE QPSK QAM16 QAM64 [:SENSE] :EVM:DLINk:PROFile:PMCH:SUBFrame8:MODulation:TY PE?
Example:	EVM:DLIN:PROF:PMCH:SUBF8:MOD:TYPE QAM16 EVM:DLIN:PROF:PMCH:SUBF8:MOD:TYPE?
Notes:	Changes to this parameter will not be applied until Update Changes command is sent. See “RB Parameter Manager (Downlink)” on page 915 section for more details.
Dependencies:	Available when MBSFN Active is On , MBSFN Subframe8 is On and PMCH Subframe8 is On. Otherwise, this key is grayed out.

LTE Modulation Analysis Measurement
Meas Setup (Measurement Setup)

Preset:	QPSK
State Saved:	Saved in instrument state.
Range:	QPSK 16QAM 64QAM
Initial S/W Revision:	A.11.00
Help Map ID:	40953

PMCH Subframe9 Mod Type

Selects PMCH channel's Modulation Type for Subframe9 when Detection is Manual.

Key Path:	Meas Setup, Chan Profile Setup, Edit Control Channels
Mode:	LTETDD
Remote Command:	[:SENSE] :EVM:DLINk:PROFile:PMCH:SUBFrame9:MODulation:TY PE QPSK QAM16 QAM64 [:SENSe] :EVM:DLINk:PROFile:PMCH:SUBFrame9:MODulation:TY PE?
Example:	EVM:DLIN:PROF:PMCH:SUBF9:MOD:TYPE QAM16 EVM:DLIN:PROF:PMCH:SUBF9:MOD:TYPE?
Notes:	Changes to this parameter will not be applied until Update Changes command is sent. See “RB Parameter Manager (Downlink)” on page 915 section for more details.
Dependencies:	Available when Mode is LTETDD. Available when MBSFN Active is On, MBSFN Subframe9 is On and PMCH Subframe9 is On. Otherwise, this key is grayed out.
Preset:	QPSK
State Saved:	Saved in instrument state.
Range:	QPSK 16QAM 64QAM
Initial S/W Revision:	A.11.00
Help Map ID:	40954

Edit User Mapping (Downlink)

Displays the LTE Allocation Editor that enables you to edit the Downlink channel parameters. When a parameter is selected, the corresponding softkeys will appear.

Use **Tab** key to select a parameter field to edit. The rotary knob can be also used to select a parameter field as it has two functions: value adjustment (default) and field navigation. Use **Enter** key to toggle the function.

In order to apply or discard changes, select OK button or Cancel button on the editor to show the corresponding softkeys and press either of them. These softkeys also appear by pressing **Cancel (Esc)** key when the active function is disabled.

NOTE If Help is open when you select this key, the dialog and menu does not appear. Close Help by pressing **Cancel (Esc)**, then select this key. After the menu has changed, press the green **Help** key to see Help for the dialog and keys. Close Help when you are ready to edit the parameters.

Key Path:	Meas Setup, Chan Profile Setup
Mode:	LTE, LTETDD
Initial S/W Revision:	Prior to A.02.00
Modified at S/W Revision:	A.03.00, A.06.00
Help Map ID:	29198

This table lists all the parameters available to set up downlink PDSCH user allocations.

Parameter	Description
Detection	When Auto, the demodulator will autodetect PDSCH user allocations. The only parameter needed is Power Boost (for EVM calculations). RB Autodetect groups resource blocks that contain the same modulation type into a user so that there are three possible users: QPSK, QAM16, and QAM64.
RB Auto Detect Mode	Specifies how the LTE demodulator detects user allocations when Detection is Auto.
Auto Detect Power Levels	Selects whether or not power levels are autodetected. Enabled only when RB Auto Detect is On and RB Auto Detect Mode is Decoded PDCCH.
Use Per Antenna EPRE	Determines whether the EPRE is interpreted as energy per antenna port or the sum total of energies contributed by all antenna ports involved. When it is On, EPRE is interpreted as energy per antenna port.
Multi-Frame Analysis	When On, the demodulator enables user to setup PDSCH allocations for two continuous frames. This parameter needs to be set to On when the signal under analysis is complied with E-UTRA TDD Test Models defined in 3GPP TS36.141 6.1.1 V8.2.0.
Show Mapping	Specifies which frame's allocation will be shown in RB Mapping diagram when Multi-Frame Analysis is On.
Include	When this check box is selected, the corresponding user mapping is displayed on appropriate traces. When cleared, only the Frame Summary trace will display the user mapping.
Add	Adds a user mapping.
Delete	Deletes the selected user mapping.
RNTI	Sets the radio network temporary identifier for the user. Enabled only when Detection is manual. (TDD only)
UE-RS Active	Selects whether the UE-specific reference signal is present in the signal under test. Enabled only when Detection is manual. (TDD only)

LTE Modulation Analysis Measurement
Meas Setup (Measurement Setup)

UE-RS Include	Selects whether the UE-specific reference signal is included in the analysis results. Enabled only when UE-RS Active is On and Detection is manual. (TDD only)
UE-RS Power	Specifies the power boost for the UE-specific reference signal. Enabled only when Detection is manual. (TDD only)
UE-RS Port	Specifies on which logical antenna port UE-RS is transmitted for the selected PDSCH user allocation. (TDD only)
UE-RS nSCID	Specifies downlink user's scrambling identity value nSCID(TDD only)
Precoding Parameters	
Precoding	Specifies the type of shared channel precoding method that the demodulator should expect.
Number of layers	Specifies the number of layers. It's less than or equal to the number of antenna ports used for transmission of the physical channel.
Number of codewords	Specifies the number of codewords.
CDD	Specifies whether precoding will be done with or without CDD (cyclic delay diversity) for spatial multiplexing.
Codebook Index	Specifies the Codebook index for spatial multiplexing precoding.
PDSCH Per-allocation Parameters	
Couple	Certain parameters can be coupled across all RB allocation groups for a user or can be set independently for each RB allocation group. Selecting the checkbox next to a parameter will couple that parameter across all RB allocation groups.
RB Start	Specifies the RB start boundary of the current allocation group for the current user.
RB End	Specifies the RB end boundary of the current allocation group for the current user.
Slot Start	Specifies the slot start boundary of the current allocation group for the current user.
Slot End	Specifies the slot end boundary of the current allocation group for the current user.
Allocation EPRE	Sets the EPRE value for the selected Allocation.
Codeword 0 Mod Type	Modulation type for codeword 0: QPSK, QAM16, or QAM64.
Codeword 1 Mod Type	Modulation type for codeword 1: QPSK, QAM16, or QAM64.
Codeword 0 Power Boost	The power of the subcarriers relative to the 0 dB level determined by the RS power level for codeword 0. See “Chan Profile Setup (Downlink)” on page 789 for more information.
Codeword 1 Power Boost	The power of the subcarriers relative to the 0 dB level determined by the RS power level for codeword 1. See “Chan Profile Setup (Downlink)” on page 789 for more information.

Frame Index	Specifies which frame of the current allocation for the current user belongs to.
Add	Adds an allocation to the selected user.
Delete	Deletes the selected allocation.

Detection

See [Detection@29131@i.](#)

Key Path:	Meas Setup, Chan Profile Setup, Edit User Mapping
Help Map ID:	Use 29131

RB Auto Detect Mode

See [RB Auto Detect Mode@29084@i.](#)

Key Path:	Meas Setup, Chan Profile Setup, Edit User Mapping
Help Map ID:	Use 29084

Auto Detect Power Levels

See [Auto Detect Power Levels@29090@i.](#)

Key Path:	Meas Setup, Chan Profile Setup, Edit User Mapping
Help Map ID:	Use 29090

Use Per Antenna EPRE

Determines whether the EPRE is interpreted as energy per antenna port or the sum total of energies contributed by all antenna ports involved . When it is On, EPRE is interpreted as energy per antenna port.

Key Path:	Meas Setup, Chan Profile Setup, Edit User Mapping
Mode:	LTE, LTETDD
Remote Command:	[:SENSE] :EVM:DLINK:PROFile:EPRE:PANTenna OFF ON 0 1 [:SENSE] :EVM:DLINK:PROFile:EPRE:PANTenna?
Example:	EVM:DLINK:PROF:EPRE:PANT ON EVM:DLINK:PROF:EPRE:PANT?

LTE Modulation Analysis Measurement
Meas Setup (Measurement Setup)

Notes:	Changes to this parameter will not be applied until Update Changes command is sent. See Section “ RB Parameter Manager (Downlink) ” on page 915, “ RB Parameter Manager (Downlink) ” on page 915 section for more details.
Preset:	ON
State Saved:	Saved in instrument state.
Initial S/W Revision:	A.11.00
Help Map ID:	40955

Multi-Frame Analysis

Determines whether or not the Multi-Frame Analysis is selected.

When On, the demodulator sets PDSCH allocations for two continuous frames. This parameter needs to be set to On when the signal under analysis is complied with E-UTRA TDD Test Models defined in 3GPP TS36.141 6.1.1 V8.2.0.

NOTE Multi-Frame Analysis is only available for LTETDD downlink and only enabled when detection is manual.

Key Path:	Meas Setup, Chan Profile Setup, Edit User Mapping, Detection
Mode:	LTETDD
Remote Command:	[[:SENSE]:EVM:PROfile:MFANalysis OFF ON 0 1 [:SENSE]:EVM:PROfile:MFANalysis?
Example:	EVM:PROF:MFAN ON EVM:PROF:MFAN?
Notes:	Changes to this parameter will not be applied until Update Changes command is sent. See “ RB Parameter Manager (Downlink) ” on page 915 section for more details.
Dependencies:	Available only for LTETDD downlink. Enabled when Detection is Manual and Input Channel is 1.
Preset:	OFF
State Saved:	Saved in instrument state.
Initial S/W Revision:	Prior to A.02.00
Modified at S/W Revision:	A.03.00
Help Map ID:	40761

Show Mapping

Selects which frame’s allocations you want to see in RB mapping diagram when Multi Frame Analysis

is On.

Key Path:	Meas Setup, Chan Profile Setup, Edit User Mapping, Detection
Mode:	LTETDD
Remote Command:	[:SENSe] :EVM:PROFile:SMAPping[:SELEct] F0 F1 [:SENSe] :EVM:PROFile:SMAPping[:SELEct] ?
Example:	EVM:PROF:SMAP F0 EVM:PROF:SMAP?
Notes:	Changes to this parameter will not be applied until Update Changes command is sent. See “RB Parameter Manager (Downlink)” on page 915 section for more details.
Dependencies:	Available only for LTETDD downlink. Enabled when Multi-Frame Analysis is ON.
Preset:	F0
State Saved:	Saved in instrument state.
Range:	F0 F1
Initial S/W Revision:	Prior to A.02.00
Modified at S/W Revision:	A.03.00
Help Map ID:	40762

Frame 0

Selects Frame 0 for Show Mapping For to be used by all the Allocations when Multi-Frame Analysis is On.

Key Path:	Meas Setup, Chan Profile Setup, Edit User Mapping, Detection, Show Mapping
Mode:	LTETDD
Initial S/W Revision:	Prior to A.02.00
Modified at S/W Revision:	A.03.00
Help Map ID:	40763

Frame 1

Selects Frame 1 for Show Mapping For to be used by all the Allocations when Multi-Frame Analysis is On.

Key Path:	Meas Setup, Chan Profile Setup, Edit User Mapping, Detection, Show Mapping
Mode:	LTETDD
Initial S/W Revision:	Prior to A.02.00

LTE Modulation Analysis Measurement
Meas Setup (Measurement Setup)

Modified at S/W Revision:	A.03.00
Help Map ID:	40764

Add Allocation

Adds a new Allocation after the currently selected Allocation and the new entry becomes the selected Allocation. The new Allocation will have the parameters set to the default values.

Key Path:	Meas Setup, Chan Profile Setup, Edit User Mapping, Allocation
Mode:	LTE, LTETDD
Remote Command:	[:SENSE] :EVM:DLINK:PROF:USER<n>:PDSCh:ADD:ALLOCATION
Example:	EVM:DLIN:PROF:USER1:PDSC:ADD:ALL
Notes:	Changes to this parameter will not be applied until Update Changes command is sent. See “RB Parameter Manager (Downlink)” on page 915 section for more details.
Dependencies:	The range of sub op code <n> values is determined by the number of Users the user has configured. The new Allocation will be added at the end of the currently defined Allocation. Disabled once the number of Allocations reaches to 250 (max).
Initial S/W Revision:	Prior to A.02.00
Modified at S/W Revision:	A.03.00
Help Map ID:	29161

Delete Allocation

Deletes the currently selected Allocation.

Key Path:	Meas Setup, Chan Profile Setup, Edit User Mapping, Allocation
Mode:	LTE, LTETDD
Remote Command:	[:SENSE] :EVM:DLINK:PROF:USER<n>:PDSCh:RBALLOc<m>:DELETE
Example:	EVM:DLIN:PROF:USER1:PDSC:RBAL1:DEL
Notes:	Changes to this parameter will not be applied until Update Changes command is sent. See “RB Parameter Manager (Downlink)” on page 915 section for more details.

Dependencies:	<p>Disabled when there is only one Allocation.</p> <p>The range of sub op code <n> values is determined by the number of Users the user has configured. The range of sub op code <m> values is determined by the number of Allocations the user has configured. . Max value for n=50. Max Value for m=250.</p> <p>If the user attempts to delete a Slot that does not exist, an error message will be generated.</p>
Backwards Compatibility SCPI:	[[:SENSE]:EVM:DLINK:PROFile:USER<n>:PDSCh:ALLocation<m>:DELet e (Max value for n=50 and m=50)
Initial S/W Revision:	Prior to A.02.00
Modified at S/W Revision:	A.03.00, A.06.00
Help Map ID:	29162

Include PDSCH

Determines whether or not the PDSCH is included in the results.

Key Path:	Meas Setup, Chan Profile Setup, Edit User Mapping
Mode:	LTE, LTETDD
Couplings:	<p>This parameter provides the Include/Exclude status of the currently selected User, therefore the SCPI commands associated with this parameter will change as the User is changed.</p> <p>When Detection is Auto;</p> <p>when selected User is QPSK, refer to “Include QPSK” on page 803</p> <p>when selected User is 16QAM, refer to “Include 16QAM” on page 804</p> <p>when selected User is 64QAM, refer to “Include 64QAM” on page 804</p> <p>When Detection is Manual, refer to “Include PDSCH” on page 802</p>
Preset:	EXCLude
State Saved:	Saved in instrument state.
Range:	Include Exclude
Modified at S/W Revision:	A.03.00
Help Map ID:	30759

RNTI

Sets downlink user's radio network temporary identifier.

Key Path:	Meas Setup, Chan Profile Setup, Edit User Mapping
Mode:	LTETDD

LTE Modulation Analysis Measurement
Meas Setup (Measurement Setup)

Remote Command:	[:SENSE] :EVM:DLINK:PROFile:USER<n>:RNTI <integer> [:SENSE] :EVM:DLINK:PROFile:USER<n>:RNTI?
Example:	EVM:DLIN:PROF:USER1:RNTI 1 EVM:DLIN:PROF:USER1:RNTI?
Notes:	Changes to this parameter will not be applied until Update Changes command is sent. See “RB Parameter Manager (Downlink)” on page 915 section for more details.
Dependencies:	The range of sub op code <n> values is determined by the number of Users the user has configured. If the user attempts to remotely set or query a sub op code that is out of range, this will result in an error message. LTE TDD only. Available when Detection is Manual, UE-RS Active is On and UE-RS Port is Port5.
Preset:	0
State Saved:	Saved in instrument state.
Min:	0
Max:	65535
Initial S/W Revision:	A.06.00
Help Map ID:	29200

Auto Detect RNTI for QPSK

Sets radio network temporary identifier for the QPSK modulation when Detection is Auto.

Key Path:	Meas Setup, Chan Profile Setup, Edit User Mapping
Mode:	LTETDD
Remote Command:	[:SENSE] :EVM:DLINK:PROFile:QPSK:RNTI <integer> [:SENSE] :EVM:DLINK:PROFile:QPSK:RNTI?
Example:	EVM:DLIN:PROF:QPSK:RNTI 1 EVM:DLIN:PROF:QPSK:RNTI?
Notes:	Changes to this parameter will not be applied until Update Changes command is sent. See section 3.11.7.16.22 RB Parameter Manager (Downlink) for more details.
Dependencies:	Available when Detection is Auto, RB Auto Detect Mode is Power Based, UE-RS Active is On, and UE-RS Port is Port5.
Preset:	0
State Saved:	Saved in instrument state.
Min:	0

Max:	65535
Initial S/W Revision:	A.10.00
Help Map ID:	0

Auto Detect RNTI for 16QAM

Sets radio network temporary identifier for the 16QAM modulation when Detection is Auto.

Key Path:	Meas Setup, Chan Profile Setup, Edit User Mapping
Mode:	LTETDD
Remote Command:	[:SENSE] :EVM:DLINK:PROFile:QAM16:RNTI <integer> [:SENSE] :EVM:DLINK:PROFile:QAM16:RNTI?
Example:	EVM:DLIN:PROF:QAM16:RNTI 1 EVM:DLIN:PROF:QAM16:RNTI?
Notes:	Changes to this parameter will not be applied until Update Changes command is sent. See section 3.11.7.16.22 RB Parameter Manager (Downlink) for more details.
Dependencies:	Available when Detection is Auto.
Preset:	0
State Saved:	Saved in instrument state.
Min:	0
Max:	65535
Initial S/W Revision:	A.10.00
Help Map ID:	0

Auto Detect RNTI for 64QAM

Sets radio network temporary identifier for the 64QAM modulation when Detection is Auto.

Key Path:	Meas Setup, Chan Profile Setup, Edit User Mapping
Mode:	LTETDD
Remote Command:	[:SENSE] :EVM:DLINK:PROFile:QAM64:RNTI <integer> [:SENSE] :EVM:DLINK:PROFile:QAM64:RNTI?
Example:	EVM:DLIN:PROF:QAM64:RNTI 1 EVM:DLIN:PROF:QAM64:RNTI?
Notes:	Changes to this parameter will not be applied until Update Changes command is sent. See section 3.11.7.16.22 RB Parameter Manager (Downlink) for more details.

LTE Modulation Analysis Measurement
Meas Setup (Measurement Setup)

Dependencies:	Available when Detection is Auto, RB Auto Detect Mode is Power Based, UE-RS Active is On, and UE-RS Port is Port5.
Preset:	0
State Saved:	Saved in instrument state.
Min:	0
Max:	65535
Initial S/W Revision:	A.10.00
Help Map ID:	0

UE-RS Active

Selects whether or not the UE specific reference signal exists for this downlink user in the input signal.

Key Path:	Meas Setup, Chan Profile Setup, Edit User Mapping
Mode:	LTETDD
Remote Command:	[:SENSe] :EVM:DLINk:PROFile:USER<n>:UERS:ACTive OFF ON 0 1 [:SENSe] :EVM:DLINk:PROFile:USER<n>:UERS:ACTive?
Example:	EVM:DLIN:PROF:USER1:UERS:ACT OFF EVM:DLIN:PROF:USER1:UERS:ACT?
Notes:	Changes to this parameter will not be applied until Update Changes command is sent. See “ RB Parameter Manager (Downlink) ” on page 915 section for more details.
Dependencies:	Available when Detection is Manual. All softkeys for UE-RS parameters are grayed out when this parameter is set to OFF. LTE TDD only.
Preset:	OFF
State Saved:	Saved in instrument state.
Range:	On Off
Initial S/W Revision:	A.06.00
Help Map ID:	29201

Auto Detect UE-RS Active for QPSK

Selects whether or not the UE specific reference signal exists for the QPSK modulation when Detection is Auto.

Key Path:	Meas Setup, Chan Profile Setup, Edit User Mapping
-----------	--

Mode:	LTETDD
Remote Command:	[:SENSE] :EVM:DLINK:PROFile:QPSK:UERS:ACTive OFF ON 0 1 [:SENSE] :EVM:DLINK:PROFile:QPSK:UERS:ACTive?
Example:	EVM:DLIN:PROF:QPSK:UERS:ACT OFF EVM:DLIN:PROF:QPSK:UERS:ACT?
Notes:	Changes to this parameter will not be applied until Update Changes command is sent. See section 3.11.7.16.22 RB Parameter Manager (Downlink) for more details.
Dependencies:	Available when Detection is Auto. All softkeys for UE-RS parameters are grayed out when this parameter is set to OFF. LTE TDD only.
Preset:	OFF
State Saved:	Saved in instrument state.
Range:	On Off
Initial S/W Revision:	A.10.00
Help Map ID:	0

Auto Detect UE-RS Active for 16QAM

Selects whether or not the UE specific reference signal exists for the 16QAM modulation when Detection is Auto.

Key Path:	Meas Setup, Chan Profile Setup, Edit User Mapping
Mode:	LTETDD
Remote Command:	[:SENSE] :EVM:DLINK:PROFile:QAM16:UERS:ACTive OFF ON 0 1 [:SENSE] :EVM:DLINK:PROFile:QAM16:UERS:ACTive?
Example:	EVM:DLIN:PROF:QAM16:UERS:ACT OFF EVM:DLIN:PROF:QAM16:UERS:ACT?
Notes:	Changes to this parameter will not be applied until Update Changes command is sent. See section 3.11.7.16.22 RB Parameter Manager (Downlink) for more details.
Dependencies:	Available when Detection is Auto. All softkeys for UE-RS parameters are grayed out when this parameter is set to OFF. LTE TDD only.
Preset:	OFF
State Saved:	Saved in instrument state.
Range:	On Off

LTE Modulation Analysis Measurement
Meas Setup (Measurement Setup)

Initial S/W Revision:	A.10.00
Help Map ID:	0

Auto Detect UE-RS Active for 64QAM

Selects whether or not the UE specific reference signal exists for 64QAM modulation when Detection is Auto.

Key Path:	Meas Setup, Chan Profile Setup, Edit User Mapping
Mode:	LTETDD
Remote Command:	[:SENSE] :EVM:DLINK:PROF:QAM64:UERS:ACTive OFF ON 0 1 [:SENSE] :EVM:DLINK:PROF:QAM64:UERS:ACTive?
Example:	EVM:DLIN:PROF:QAM64:UERS:ACT OFF EVM:DLIN:PROF:QAM64:UERS:ACT?
Notes:	Changes to this parameter will not be applied until Update Changes command is sent. See section 3.11.7.16.22 RB Parameter Manager (Downlink) for more details.
Dependencies:	Available when Detection is Auto. All softkeys for UE-RS parameters are grayed out when this parameter is set to OFF. LTE TDD only.
Preset:	OFF
State Saved:	Saved in instrument state.
Range:	On Off
Initial S/W Revision:	A.10.00
Help Map ID:	0

Include UE-RS

Includes the user defined channel PDSCH's UE specific reference signal in the results.

Key Path:	Meas Setup, Chan Profile Setup, Include Users
Mode:	LTETDD
Remote Command:	[:SENSE] :EVM:DLINK:PROF:USER<n>:UERS INCLude EXCLude [:SENSE] :EVM:DLINK:PROF:USER<n>:UERS?
Example:	EVM:DLIN:PROF:USER1:UERS EXCL EVM:DLIN:PROF:USER1:UERS?

Notes:	Changes to this parameter will not be applied until Update Changes command is sent. See “ RB Parameter Manager (Downlink) ” on page 915 section for more details.
Dependencies:	The range of sub op code <n> values is determined by the number of Users the user has configured. If the user attempts to remotely set or query a sub op code that is out of range, this will result in an error message. Available when UE-RS Active is ON and Detection is Manual. LTE TDD only.
Couplings:	This parameter is set to Include when Downlink Include All is selected and set to Exclude when Downlink Exclude All is selected.
Preset:	EXCLude
State Saved:	Saved in instrument state.
Range:	Include Exclude
Initial S/W Revision:	A.06.00
Help Map ID:	29206

Auto Detect Include UE-RS for QPSK

Includes UE specific reference signal for the QPSK modulation in the results when Detection is Auto.

Key Path:	Meas Setup, Chan Profile Setup, Include Users
Mode:	LTETDD
Remote Command:	[:SENSe] :EVM:DLINk:PROFile:QPSK:UERS INCLude EXCLude [:SENSe] :EVM:DLINk:PROFile:QPSK:UERS?
Example:	EVM:DLIN:PROF:QPSK:UERS EXCL EVM:DLIN:PROF:QPSK:UERS?
Dependencies:	Available when UE-RS Active is ON and Detection is Auto.
Couplings:	This parameter is set to Include when Downlink Include All is selected and set to Exclude when Downlink Exclude All is selected.
Preset:	EXCLude
State Saved:	Saved in instrument state.
Range:	Include Exclude
Initial S/W Revision:	A.10.00
Help Map ID:	0

Auto Detect Include UE-RS for 16QAM

Includes UE specific reference signal for the 16QAM modulation in the results when Detection is Auto.

Key Path:	Meas Setup, Chan Profile Setup, Include Users
Mode:	LTETDD
Remote Command:	[:SENSE] :EVM:DLINK:PROF:QAM16:UERS INCLude EXCLude [:SENSE] :EVM:DLINK:PROF:QAM16:UERS?
Example:	EVM:DLIN:PROF:QAM16:UERS EXCL EVM:DLIN:PROF:QAM16:UERS?
Dependencies:	Available when UE-RS Active is ON and Detection is Auto.
Couplings:	This parameter is set to Include when Downlink Include All is selected and set to Exclude when Downlink Exclude All is selected.
Preset:	EXCLude
State Saved:	Saved in instrument state.
Range:	Include Exclude
Initial S/W Revision:	A.10.00
Help Map ID:	0

Auto Detect Include UE-RS for 64QAM

Includes UE specific reference signal for the 64QAM modulation in the results when Detection is Auto.

Key Path:	Meas Setup, Chan Profile Setup, Include Users
Mode:	LTETDD
Remote Command:	[:SENSE] :EVM:DLINK:PROF:QAM64:UERS INCLude EXCLude [:SENSE] :EVM:DLINK:PROF:QAM64:UERS?
Example:	EVM:DLIN:PROF:QAM64:UERS EXCL EVM:DLIN:PROF:QAM64:UERS?
Dependencies:	Available when UE-RS Active is ON and Detection is Auto.
Couplings:	This parameter is set to Include when Downlink Include All is selected and set to Exclude when Downlink Exclude All is selected.
Preset:	EXCLude
State Saved:	Saved in instrument state.
Range:	Include Exclude
Initial S/W Revision:	A.10.00
Help Map ID:	0

UE-RS Power Boost

Sets the Power Boost value for the specified user. Power Boost value specifies the average power for the UE-specific reference signal.

The average power of the UE-RS power is relative to the 0 dB level determined by the cell-specific RS power level.

Key Path:	Meas Setup, Chan Profile Setup, Edit User Mapping
Mode:	LTETDD
Remote Command:	[:SENSe] :EVM:DLINk:PROFile:USER<n>:UERS:PWRBoost <rel_ampl> [:SENSe] :EVM:DLINk:PROFile:USER<n>:UERS:PWRBoost?
Example:	EVM:DLIN:PROF:USER1:UERS:PWRB 0 EVM:DLIN:PROF:USER1:UERS:PWRB?
Notes:	Changes to this parameter will not be applied until Update Changes command is sent. See “RB Parameter Manager (Downlink)” on page 915 section for more details.
Dependencies:	The range of sub op code <n> values is determined by the number of Users the user has configured. Max value for n=50. If the user attempts to remotely set or query a sub op code that is out of range, this will result in an error message. available when Detection is Manual. LTE TDD only.
Preset:	0 dB
State Saved:	Saved in instrument state.
Min:	-100 dB
Max:	100 dB
Initial S/W Revision:	A.06.00
Help Map ID:	29218

Auto Detect UE-RS Power Boost for QPSK

Determines the Power Boost value for the QPSK modulation when Detection is Auto. Power Boost value specifies the average power for the UE-specific reference signal. The average power of the UE-RS power is relative to the 0 dB level determined by the cell-specific RS power level.

Key Path:	Meas Setup, Chan Profile Setup, Edit User Mapping
Mode:	LTETDD

LTE Modulation Analysis Measurement
Meas Setup (Measurement Setup)

Remote Command:	[:SENSe] :EVM:DLINk:PROFile:QPSK:UERS:PWRBoost <rel_ampl> [:SENSe] :EVM:DLINk:PROFile:QPSK:UERS:PWRBoost?
Example:	EVM:DLIN:PROF:QPSK:UERS:PWRB 0 EVM:DLIN:PROF:QPSK:UERS:PWRB?
Notes:	Changes to this parameter will not be applied until Update Changes command is sent. See section 3.11.7.16.22 RB Parameter Manager (Downlink) for more details.
Dependencies:	Available when Detection is Auto.
Preset:	0 dB
State Saved:	Saved in instrument state.
Min:	-100 dB
Max:	100 dB
Initial S/W Revision:	A.10.00
Help Map ID:	0

Auto Detect UE-RS Power Boost for 16QAM

Determine the Power Boost value for the 16QAM modulation when Detection is Auto. Power Boost value specifies the average power for the UE-specific reference signal. The average power of the UE-RS power is relative to the 0 dB level determined by the cell-specific RS power level.

Key Path:	Meas Setup, Chan Profile Setup, Edit User Mapping
Mode:	LTETDD
Remote Command:	[:SENSe] :EVM:DLINk:PROFile:QAM16:UERS:PWRBoost <rel_ampl> [:SENSe] :EVM:DLINk:PROFile:QAM16:UERS:PWRBoost?
Example:	EVM:DLIN:PROF:QAM16:UERS:PWRB 0 EVM:DLIN:PROF:QAM16:UERS:PWRB?
Notes:	Changes to this parameter will not be applied until Update Changes command is sent. See section 3.11.7.16.22 RB Parameter Manager (Downlink) for more details.
Dependencies:	Available when Detection is Auto.
Preset:	0 dB
State Saved:	Saved in instrument state.
Min:	-100 dB
Max:	100 dB

Initial S/W Revision:	A.10.00
Help Map ID:	0

Auto Detect UE-RS Power Boost for 64QAM

Determines the Power Boost value for the 64QAM modulation when Detectio is Auto. Power Boost value specifies the average power for the UE-specific reference signal. The average power of the UE-RS power is relative to the 0 dB level determined by the cell-specific RS power level.

Key Path:	Meas Setup, Chan Profile Setup, Edit User Mapping
Mode:	LTETDD
Remote Command:	[:SENSE] :EVM:DLINK:PROFile:QAM64:UERS:PWRBoost <rel_ampl> [:SENSE] :EVM:DLINK:PROFile:QAM64:UERS:PWRBoost?
Example:	EVM:DLIN:PROF:QAM64:UERS:PWRB 0 EVM:DLIN:PROF:QAM64:UERS:PWRB?
Notes:	Changes to this parameter will not be applied until Update Changes command is sent. See section 3.11.7.16.22 RB Parameter Manager (Downlink) for more details.
Dependencies:	Available when Detection is Auto.
Preset:	0 dB
State Saved:	Saved in instrument state.
Min:	-100 dB
Max:	100 dB
Initial S/W Revision:	A.10.00
Help Map ID:	0

UE-RS Port

Specifies on which logical antenna port UE-RS is transmitted for the selected PDSCH user allocation when Detectin is Manual.

Key Path:	Meas Setup, Chan Profile Setup, Edit User Mapping
Mode:	LTETDD
Remote Command:	[:SENSE] :EVM:DLINK:PROFile:USER<n>:UERS:PORT P5 P7 P8 [:SENSE] :EVM:DLINK:PROFile:USER<n>:UERS:PORT?
Example:	EVM:DLIN:PROF:USER1:UERS:PORT P5 EVM:DLIN:PROF:USER1:UERS:PORT?

LTE Modulation Analysis Measurement
Meas Setup (Measurement Setup)

Notes:	Changes to this parameter will not be applied until Update Changes command is sent. See section 3.11.7.16.22 RB Parameter Manager (Downlink) for more details.
Dependencies:	The range of sub op code <n> values is determined by the number of Users the user has configured. Max value for n= 50 If the user attempts to remotely set or query a sub op code that is out of range, this will result in an error message. Enabled when Detection is Manual, and UE-RS Active is On
Preset:	P5
State Saved:	Saved in instrument state.
Range:	P5 P7 P8
Initial S/W Revision:	A.10.00
Help Map ID:	40768

Auto Detect UE-RS Port for QPSK

Specifies on which logical antenna port UE-RS is transmitted for the QPSK modulation when Detection is Auto.

Key Path:	Meas Setup, Chan Profile Setup, Edit User Mapping
Mode:	LTETDD
Remote Command:	[:SENSe] :EVM:DLINk:PROFile:QPSK:UERS:PORT P5 P7 P8 [:SENSe] :EVM:DLINk:PROFile:QPSK:UERS:PORT?
Example:	EVM:DLIN:PROF:QPSK:UERS:PORT P5 EVM:DLIN:PROF:QPSK:UERS:PORT?
Notes:	Changes to this parameter will not be applied until Update Changes command is sent. See section 3.11.7.16.22 RB Parameter Manager (Downlink) for more details.
Dependencies:	Enabled when Detection is Auto, and UE-RS Active is On
Preset:	P5
State Saved:	Saved in instrument state.
Range:	P5 P7 P8
Initial S/W Revision:	A.10.00
Help Map ID:	0

Auto Detect UE-RS Port for 16QAM

Specifies on which logical antenna port UE-RS is transmitted for the 16QAM modulation when

Detection is Auto.

Key Path:	Meas Setup, Chan Profile Setup, Edit User Mapping
Mode:	LTETDD
Remote Command:	[:SENSE] :EVM:DLINK:PROF:QAM16:UERS:PORT P5 P7 P8 [:SENSE] :EVM:DLINK:PROF:QAM16:UERS:PORT?
Example:	EVM:DLIN:PROF:QAM16:UERS:PORT P5 EVM:DLIN:PROF:QAM16:UERS:PORT?
Notes:	Changes to this parameter will not be applied until Update Changes command is sent. See section 3.11.7.16.22 RB Parameter Manager (Downlink) for more details.
Dependencies:	Enabled when Detection is Auto, and UE-RS Active is On
Preset:	P5
State Saved:	Saved in instrument state.
Range:	P5 P7 P8
Initial S/W Revision:	A.10.00
Help Map ID:	0

Auto Detect UE-RS Port for 64QAM

Specifies on which logical antenna port UE-RS is transmitted for the 64QAM modulation when Detection is Auto.

Key Path:	Meas Setup, Chan Profile Setup, Edit User Mapping
Mode:	LTETDD
Remote Command:	[:SENSE] :EVM:DLINK:PROF:QAM64:UERS:PORT P5 P7 P8 [:SENSE] :EVM:DLINK:PROF:QAM64:UERS:PORT?
Example:	EVM:DLIN:PROF:QAM64:UERS:PORT P5 EVM:DLIN:PROF:QAM64:UERS:PORT?
Notes:	Changes to this parameter will not be applied until Update Changes command is sent. See section 3.11.7.16.22 RB Parameter Manager (Downlink) for more details.
Dependencies:	Enabled when Detection is Auto, and UE-RS Active is On
Preset:	P5
State Saved:	Saved in instrument state.
Range:	P5 P7 P8
Initial S/W Revision:	A.10.00

Help Map ID:	0
--------------	---

UE-RS n_{SCID}

Specifies downlink user's scrambling identity value n_{SCID} when Detection is Manual.

Key Path:	Meas Setup, Chan Profile Setup, Edit User Mapping
Mode:	LTETDD
Remote Command:	[:SENSE] :EVM:DLINK:PROFile:USER<n>:UERS:SCID <integer> [:SENSE] :EVM:DLINK:PROFile:USER<n>:UERS:SCID?
Example:	EVM:DLIN:PROF:USER1:UERS:SCID 0 EVM:DLIN:PROF:USER1:UERS:SCID?
Notes:	Changes to this parameter will not be applied until Update Changes command is sent. See section 3.11.7.16.22 RB Parameter Manager (Downlink) for more details.
Dependencies:	The range of sub op code <n> values is determined by the number of Users the user has configured. If the user attempts to remotely set or query a sub op code that is out of range, this will result in an error message. Available when Detection is Manual and UE-RS Active is On and UE-RS Port is not Port5.
Preset:	0
State Saved:	Saved in instrument state.
Min:	0
Max:	1
Initial S/W Revision:	A.10.00
Help Map ID:	40769

Auto Detect UE-RS n_{SCID} for QPSK

Specifies scrambling identity value n_{SCID} for the QPSK modulation when Detection is Auto.

Key Path:	Meas Setup, Chan Profile Setup, Edit User Mapping
Mode:	LTETDD
Remote Command:	[:SENSe] :EVM:DLINK:PROFile:QPSK:UERS:SCID <integer> [:SENSe] :EVM:DLINK:PROFile:QPSK:UERS:SCID?
Example:	EVM:DLIN:PROF:QPSK:UERS:SCID 0 EVM:DLIN:PROF:QPSK:UERS:SCID?

Notes:	Changes to this parameter will not be applied until Update Changes command is sent. See section 3.11.7.16.22 RB Parameter Manager (Downlink) for more details.
Dependencies:	Available when Detection is Auto, UE-RS Active is On, and UE-RS Port is not Port5.
Preset:	0
State Saved:	Saved in instrument state.
Min:	0
Max:	1
Initial S/W Revision:	A.10.00
Help Map ID:	0

Auto Detect UE-RS nSCID for 16QAM

Specifies scrambling identity value n_{SCID} for the 16QAM modulation when Detection is Auto.

Key Path:	Meas Setup, Chan Profile Setup, Edit User Mapping
Mode:	LTETDD
Remote Command:	[:SENSE] :EVM:DLINK:PROFile:QAM16:UERS:SCID <integer> [:SENSE] :EVM:DLINK:PROFile:QAM16:UERS:SCID?
Example:	EVM:DLIN:PROF:QAM16:UERS:SCID 0 EVM:DLIN:PROF:QAM16:UERS:SCID?
Notes:	Changes to this parameter will not be applied until Update Changes command is sent. See section 3.11.7.16.22 RB Parameter Manager (Downlink) for more details.
Dependencies:	Available when Detection is Auto, UE-RS Active is On, and UE-RS Port is not Port5.
Preset:	0
State Saved:	Saved in instrument state.
Min:	0
Max:	1
Initial S/W Revision:	A.10.00
Help Map ID:	0

Auto Detect UE-RS nSCID for 64QAM

Specifies scrambling identity value n_{SCID} for the 64QAM modulation when Detection is Auto.

Key Path:	Meas Setup, Chan Profile Setup, Edit User Mapping
Mode:	LTETDD
Remote Command:	[:SENSE] :EVM:DLINK:PROFile:QAM64:UERS:SCID <integer> [:SENSE] :EVM:DLINK:PROFile:QAM64:UERS:SCID?
Example:	EVM:DLIN:PROF:QAM64:UERS:SCID 0 EVM:DLIN:PROF:QAM64:UERS:SCID?
Notes:	Changes to this parameter will not be applied until Update Changes command is sent. See section 3.11.7.16.22 RB Parameter Manager (Downlink) for more details.
Dependencies:	Available when Detection is Auto, UE-RS Active is On, and UE-RS Port is not Port5.
Preset:	0
State Saved:	Saved in instrument state.
Min:	0
Max:	1
Initial S/W Revision:	A.10.00
Help Map ID:	0

Downlink Allocation Parameters

Sets downlink allocation parameters.

Key Path:	Meas Setup, Chan Profile Setup, Edit User Mapping
Help Map ID:	29378

Allocation RB Start

Sets the Resource Block start boundary of the selected Allocation.

Key Path:	Meas Setup, Chan Profile Setup, Edit User Mapping, RB Start
Mode:	LTE, LTETDD
Remote Command:	[:SENSE] :EVM:DLINK:PROFile:USER<n>:PDSCh:RBALloc<m>:RB:START <integer> [:SENSE] :EVM:DLINK:PROFile:USER<n>:PDSCh:RBALloc<m>:RB:START?

Example:	EVM:DLIN:PROF:USER1:PDSC:RBAL1:RB:STAR 0 EVM:DLIN:PROF:USER1:PDSC:RBAL1:RB:STAR?
Notes:	Changes to this parameter will not be applied until Update Changes command is sent. See “RB Parameter Manager (Downlink)” on page 915 section for more details.
Dependencies:	The range of sub op code <n> values is determined by the number of Users the user has configured. The range of sub op code <m> values is determined by the number of Allocations the user has configured. Max value for n=50. Max Value for m=250. If the user attempts to remotely set or query a sub op code that is out of range, this will result in an error message.
Couplings:	If the user attempts to set a RB Start value greater than the RB End value, both values are set to the RB Start value or clipped to the min or max value if the entered value is out of range
Preset:	0
State Saved:	Saved in instrument state.
Min:	0
Max:	5 - Bandwidth 1.4 MHz 14 - Bandwidth 3 MHz 24 - Bandwidth 5 MHz 49 - Bandwidth 10 MHz 74 - Bandwidth 15 MHz 99 - Bandwidth 20 MHz
Backwards Compatibility SCPI:	[[:SENSE]:EVM:DLINK:PROFile:USER<n>:PDSCh:ALLocation<m>:RB:STARt (Max value for n=50 and m=50)
Initial S/W Revision:	Prior to A.02.00
Modified at S/W Revision:	A.03.00, A.06.00
Help Map ID:	29168

Allocation RB End

Sets the Resource Block stop boundary of the selected Allocation.

Key Path:	Meas Setup, Chan Profile Setup, Edit User Mapping, RB End
Mode:	LTE, LTETDD
Remote Command:	[[:SENSE]:EVM:DLINK:PROFile:USER<n>:PDSCh:RBALloc<m>:RB:END <integer> [[:SENSE]:EVM:DLINK:PROFile:USER<n>:PDSCh:RBALloc<m>:RB:END?

LTE Modulation Analysis Measurement
Meas Setup (Measurement Setup)

Example:	EVM:DLIN:PROF:USER1:PDSC:RBAL1:RB:END 0 EVM:DLIN:PROF:USER1:PDSC:RBAL1:RB:END?
Notes:	Changes to this parameter will not be applied until Update Changes command is sent. See “RB Parameter Manager (Downlink)” on page 915 section for more details.
Dependencies:	The range of sub op code <n> values is determined by the number of Users the user has configured. The range of sub op code <m> values is determined by the number of Allocations the user has configured. If the user attempts to remotely set or query a sub op code that is out of range, this will result in an error message.
Couplings:	If the user attempts to set a RB End value less than the RB Start value, both values are set to the RB End value or clipped to the min or max value if the entered value is out of range
Preset:	0
State Saved:	Saved in instrument state.
Min:	0
Max:	5 - Bandwidth 1.4 MHz 14 - Bandwidth 3 MHz 24 - Bandwidth 5 MHz 49 - Bandwidth 10 MHz 74 - Bandwidth 15 MHz 99 - Bandwidth 20 MHz
Backwards Compatibility SCPI:	[[:SENSe]:EVM:DLINK:PROFile:USER<n>:PDSC:ALLocation<m>:RB:END (Max value for n=50 and m=50)
Initial S/W Revision:	Prior to A.02.00
Modified at S/W Revision:	A.03.00, A.06.00
Help Map ID:	29169

Allocation Slot Start

Sets the Slot start boundary of the selected Allocation.

Key Path:	Meas Setup, Chan Profile Setup, Edit User Mapping, Slot Start
Mode:	LTE, LTETDD
Remote Command:	[[:SENSe]:EVM:DLINK:PROFile:USER<n>:PDSC:RBALloc<m>:SLOT:START <integer> [[:SENSe]:EVM:DLINK:PROFile:USER<n>:PDSC:RBALloc<m>:SLOT:START?

Example:	EVM:DLIN:PROF:USER1:PDSC:RBAL1:SLOT:STAR 0 EVM:DLIN:PROF:USER1:PDSC:RBAL1:SLOT:STAR?
Notes:	Changes to this parameter will not be applied until Update Changes command is sent. See “RB Parameter Manager (Downlink)” on page 915 section for more details.
Dependencies:	The range of sub op code <n> values is determined by the number of Users the user has configured. The range of sub op code <m> values is determined by the number of Allocations the user has configured. Max value for n=50. Max Value for m=250. If the user attempts to remotely set or query a sub op code that is out of range, this will result in an error message.
Couplings:	If the user attempts to set a Slot Start value greater than the Slot End value, both values are set to the Slot Start value or clipped to the min or max value if the entered value is out of range
Preset:	0
State Saved:	Saved in instrument state.
Min:	0
Max:	19
Backwards Compatibility SCPI:	[:SENSe]:EVM:DLINk:PROFile:USER<n>:PDSCh:ALLoc<m>:SLOT:STARt (Max value for n=50 and m=50)
Initial S/W Revision:	Prior to A.02.00
Modified at S/W Revision:	A.03.00, A.06.00
Help Map ID:	29170

Allocation Slot End

Sets the Slot end boundary of the selected Allocation.

Key Path:	Meas Setup, Chan Profile Setup, Edit User Mapping, Slot End
Mode:	LTE, LTETDD
Remote Command:	[:SENSe]:EVM:DLINk:PROFile:USER<n>:PDSCh:RBALloc<m>:SLOT:END <integer> [:SENSe]:EVM:DLINk:PROFile:USER<n>:PDSCh:RBALloc<m>:SLOT:END?
Example:	EVM:DLIN:PROF:USER1:PDSC:RBAL1:SLOT:END 1 EVM:DLIN:PROF:USER1:PDSC:RBAL1:SLOT:END?
Notes:	Changes to this parameter will not be applied until Update Changes command is sent. See “RB Parameter Manager (Downlink)” on page 915 section for more details.

LTE Modulation Analysis Measurement
Meas Setup (Measurement Setup)

Dependencies:	The range of sub op code <n> values is determined by the number of Users the user has configured. The range of sub op code <m> values is determined by the number of Allocations the user has configured. If the user attempts to remotely set or query a sub op code that is out of range, this will result in an error message.
Couplings:	If the user attempts to set a Slot End value less than the Slot Start value, both values are set to the Slot End value or clipped to the min or max value if the entered value is out of range
Preset:	0
State Saved:	Saved in instrument state.
Min:	0
Max:	19
Backwards Compatibility SCPI:	[:SENSE]:EVM:DLINK:PROFile:USER<n>:PDSCh:ALlocation<m>:SLOT:END (Max value for n=50 and m=50)
Initial S/W Revision:	Prior to A.02.00
Modified at S/W Revision:	A.03.00, A.06.00
Help Map ID:	29171

Allocation EPRE

Sets the EPRE value for the selected Allocation.

Key Path:	Meas Setup, Chan Profile Setup, Edit User Mapping
Mode:	LTE, LTETDD
Remote Command:	[:SENSe] :EVM:DLINK:PROFile:USER<n>:PDSCh:RBALloc<m>:EPRE <rel_ampl> [:SENSe] :EVM:DLINK:PROFile:USER<n>:PDSCh:RBALloc<m>:EPRE?
Example:	EVM:DLIN:PROF:USER1:PDSC:RBAL1:EPRE 0 EVM:DLIN:PROF:USER1:PDSC:RBAL1:EPRE?
Notes:	Changes to this parameter will not be applied until Update Changes command is sent. See Section “RB Parameter Manager (Downlink)” on page 915, “RB Parameter Manager (Downlink)” on page 915 section for more details.

Dependencies:	<p>The range of sub op code <n> values is determined by the number of Users the user has configured. The range of sub op code <m> values is determined by the number of Allocations the user has configured.</p> <p>Max value for n=50. Max Value for m=250.</p> <p>If the user attempts to remotely set or query a sub op code that is out of range, this will result in an error message.</p> <p>Enabled when Detection is Manual, Use “Per Antenna” EPRE is ON and EPRE Couple is OFF.</p>
Preset:	0 dB
State Saved:	Saved in instrument state.
Min:	-100 dB
Max:	100 dB
Initial S/W Revision:	A.11.00
Help Map ID:	40956

Allocation Mod Type for Codeword 0

Selects the Modulation Type for the selected Allocation.

Key Path:	Meas Setup, Chan Profile Setup, Edit User Mapping, Mod Type
Mode:	LTE, TLTETDD
Remote Command:	<pre>[:SENSe] :EVM:DLINk:PROFile:USER<n>:PDSC:RBALloc<m>:MOD ulation:TYPE QPSK QAM16 QAM64</pre> <pre>[:SENSe] :EVM:DLINk:PROFile:USER<n>:PDSC:RBALloc<m>:MOD ulation:TYPE?</pre>
Example:	<pre>EVM:DLIN:PROF:USER1:PDSC:RBAL1:MOD:TYPE QPSK</pre> <pre>EVM:DLIN:PROF:USER1:PDSC:RBAL1:MOD:TYPE?</pre>
Notes:	Changes to this parameter will not be applied until Update Changes command is sent. See “RB Parameter Manager (Downlink)” on page 915 section for more details.
Dependencies:	<p>The range of sub op code <n> values is determined by the number of Users the user has configured. The range of sub op code <m> values is determined by the number of Allocations the user has configured.</p> <p>Max value for n=50. Max Value for m=250.</p> <p>If the user attempts to remotely set or query a sub op code that is out of range, this will result in an error message.</p> <p>Enabled when Mod Type Couple is OFF and Codeword 0 Enable is ON.</p>
Preset:	QPSK
State Saved:	Saved in instrument state.

LTE Modulation Analysis Measurement
Meas Setup (Measurement Setup)

Range:	QPSK 16QAM 64QAM
Backwards Compatibility SCPI:	[:SENSe]:EVM:DLINK:PROFile:USER<n>:PDSCh:ALLocation<m>:MODulation:TYPE QPSK QAM16 QAM64 (Max value for n=50 and m=50)
Initial S/W Revision:	Prior to A.02.00
Modified at S/W Revision:	A.03.00, A.06.00
Help Map ID:	29163

Allocation Mod Type for Codeword 1

Selects the Modulation Type of Codeword 1 for the selected Allocation.

Key Path:	Meas Setup, Chan Profile Setup, Edit User Mapping, Mod Type
Mode:	LTE, LTETDD
Remote Command:	[:SENSe]:EVM:DLINK:PROFile:USER<n>:PDSCh:RBALloc<m>:CWONe:MODulation:TYPE QPSK QAM16 QAM64 [:SENSe]:EVM:DLINK:PROFile:USER<n>:PDSCh:RBALloc<m>:CWONe:MODulation:TYPE?
Example:	EVM:DLIN:PROF:USER1:PDSC:RBAL1:CWON:MOD:TYPE QPSK EVM:DLIN:PROF:USER1:PDSC:RBAL1:CWON:MOD:TYPE?
Notes:	Changes to this parameter will not be applied until Update Changes command is sent. See “RB Parameter Manager (Downlink)” on page 915 section for more details.
Dependencies:	Always grayed out since this instrument supports only one RF input.
Preset:	QPSK
State Saved:	Saved in instrument state.
Range:	QPSK 16QAM 64QAM
Backwards Compatibility SCPI:	[:SENSe]:EVM:DLINK:PROFile:USER<n>:PDSCh:ALLocation<m>:CWONe:MODulation:TYPE QPSK QAM16 QAM64 (Max value for n=50 and m=50)
Initial S/W Revision:	A.03.00, A.06.00
Help Map ID:	40786

QPSK

Selects QPSK for the Modulation Type of the selected Allocation.

Key Path:	Meas Setup, Chan Profile Setup, Edit User Mapping, Mod Type
Mode:	LTE, LTETDD
Initial S/W Revision:	Prior to A.02.00

Modified at S/W Revision:	A.03.00
Help Map ID:	29164

16QAM

Selects 16QAM for the Modulation Type of the selected Allocation.

Key Path:	Meas Setup, Chan Profile Setup, Edit User Mapping, Mod Type
Mode:	LTE, LTETDD
Initial S/W Revision:	Prior to A.02.00
Modified at S/W Revision:	A.03.00
Help Map ID:	29358

64QAM

Selects 64QAM for the Modulation Type of the selected Allocation.

Key Path:	Meas Setup, Chan Profile Setup, Edit User Mapping, Mod Type
Mode:	LTE, LTETDD
Initial S/W Revision:	Prior to A.02.00
Modified at S/W Revision:	A.03.00
Help Map ID:	29166

Allocation Power Boost for Codeword 0

Sets the Power Boost value for the selected Allocation.

Key Path:	Meas Setup, Chan Profile Setup, Edit User Mapping
Mode:	LTE, LTETDD
Remote Command:	[:SENSE] :EVM:DLINK:PROfile:USER<n>:PDSC:RBALloc<m>:PWR Boost <rel_ampl> [:SENSE] :EVM:DLINK:PROfile:USER<n>:PDSC:RBALloc<m>:PWR Boost?
Example:	EVM:DLIN:PROF:USER1:PDSC:RBAL1:PWRB 0 EVM:DLIN:PROF:USER1:PDSC:RBAL1:PWRB?
Notes:	Changes to this parameter will not be applied until Update Changes command is sent. See “RB Parameter Manager (Downlink)” on page 915 section for more details.

LTE Modulation Analysis Measurement
Meas Setup (Measurement Setup)

Dependencies:	The range of sub op code <n> values is determined by the number of Users the user has configured. The range of sub op code <m> values is determined by the number of Allocations the user has configured. Max value for n=50. Max Value for m=250. If the user attempts to remotely set or query a sub op code that is out of range, this will result in an error message. Enabled when Detection is Manual, Use "Per-antenna" EPRE is OFF, Codeword 0 Enable is ON and Power Boost Couple is OFF.
Preset:	0 dB
State Saved:	Saved in instrument state.
Min:	-100 dB
Max:	100 dB
Backwards Compatibility SCPI:	[[:SENSE]:EVM:DLINK:PROFile:USER<n>:PDSCh:ALlocation<m>:PWRBoost (Max value for n=50 and m=50)
Initial S/W Revision:	Prior to A.02.00
Modified at S/W Revision:	A.03.00, A.04.20, A.06.00
Help Map ID:	29167

Allocation Power Boost for Codeword 1

Sets the Power Boost value of Codeword 1 for the selected Allocation.

Key Path:	Meas Setup, Chan Profile Setup, Edit User Mapping
Mode:	LTE, LTETDD
Remote Command:	[[:SENSE]:EVM:DLINK:PROFile:USER<n>:PDSCh:RBALloc<m>:CWO Ne:PWRBoost <rel_ampl> [[:SENSE]:EVM:DLINK:PROFile:USER<n>:PDSCh:RBALloc<m>:CWO Ne:PWRBoost?
Example:	EVM:DLIN:PROF:USER1:PDSC:RBAL1:CWON:PWRB 0 EVM:DLIN:PROF:USER1:PDSC:RBAL1:CWON:PWRB?
Notes:	Changes to this parameter will not be applied until Update Changes command is sent. See “RB Parameter Manager (Downlink)” on page 915 section for more details.
Dependencies:	Always grayed out since this instrument supports only one RF input.
Preset:	0 dB
State Saved:	Saved in instrument state.
Min:	-100 dB
Max:	100 dB

Backwards Compatibility SCPI:	[[:SENSe]:EVM:DLINK:PROFile:USER<n>:PDSC:ALLocation<m>:CWO Ne:PWRBoost (Max value for n=50 and m=50)
Initial S/W Revision:	A.03.00
Modified at S/W Revision:	A.04.20, A.06.00
Help Map ID:	40787

Allocation Frame Index

Specifies the Frame Index for the selected Allocation.

Key Path:	Meas Setup, Chan Profile Setup, Edit User Mapping, Frame Index
Mode:	LTETDD
Remote Command:	[[:SENSe]:EVM:DLINK:PROFile:USER<n>:PDSC:RBALloc<m>:FIN Dex F0 F1 [:SENSe]:EVM:DLINK:PROFile:USER<n>:PDSC:RBALloc<m>:FIN Dex?
Example:	EVM:DLIN:PROF:USER1:PDSC:RBAL1:FIND F0 EVM:DLIN:PROF:USER1:PDSC:RBAL1:FIND?
Notes:	Changes to this parameter will not be applied until Update Changes command is sent. See “RB Parameter Manager (Downlink)” on page 915 section for more details.
Dependencies:	The range of sub op code <n> values is determined by the number of Users the user has configured. The range of sub op code <m> values is determined by the number of Allocations the user has configured. Max value for n=50. Max Value for m=250. If the user attempts to remotely set or query a sub op code that is out of range, this will result in an error message. Enabled only for the LTE TDD mode. Enabled when Detection is Manual, Multi –Frame Analysis is ON, and Frame Index Couple is OFF.
Preset:	F0
State Saved:	Saved in instrument state.
Range:	F0 F1
Backwards Compatibility SCPI:	[[:SENSe]:EVM:DLINK:PROFile:USER<n>:PDSC:ALLocation<m>:FINDe x F0 F1 (Max value for n=50 and m=50)
Initial S/W Revision:	Prior to A.02.00
Modified at S/W Revision:	A.03.00, A.06.00
Help Map ID:	40788

PDSCH Common Mod Type

Selects the Modulation Type for all the Allocations when Mod Type Couple is On.

Key Path:	Meas Setup, Chan Profile Setup, Edit User Mapping, Mod Type
Mode:	LTE, LTETDD
Remote Command:	[:SENSE] :EVM:DLINK:PROFile:USER<n>:PDSCh:MODulation:TYPE QPSK QAM16 QAM64 [:SENSE] :EVM:DLINK:PROFile:USER<n>:PDSCh:MODulation:TYPE?
Example:	EVM:DLIN:PROF:USER1:PDSC:MOD:TYPE QPSK EVM:DLIN:PROF:USER1:PDSC:MOD:TYPE?
Notes:	Changes to this parameter will not be applied until Update Changes command is sent. See “RB Parameter Manager (Downlink)” on page 915 section for more details.
Dependencies:	The range of sub op code <n> values is determined by the number of Users the user has configured. Max value for n= 50 If the user attempts to remotely set or query a sub op code that is out of range, this will result in an error message. Enabled when Detection is Manual, Codeword 0 Enable is ON and Mod Type Couple is ON.
Preset:	QPSK
State Saved:	Saved in instrument state.
Range:	QPSK 16QAM 64QAM
Initial S/W Revision:	Prior to A.02.00
Modified at S/W Revision:	A.03.00
Help Map ID:	29202

Common Mod Type for Codeword 1

Selects the Modulation Type for Codeword 1 for all the Allocations when Mod Type Couple is On.

Key Path:	Meas Setup, Chan Profile Setup, Edit User Mapping, Mod Type
Mode:	LTE, LTETDD
Remote Command:	[:SENSE] :EVM:DLINK:PROFile:USER<n>:PDSCh:CWONe:MODulation:TYPE QPSK QAM16 QAM64 [:SENSE] :EVM:DLINK:PROFile:USER<n>:PDSCh:CWONe:MODulation:TYPE?
Example:	EVM:DLIN:PROF:USER1:PDSC:CWON:MOD:TYPE QPSK EVM:DLIN:PROF:USER1:PDSC:CWON:MOD:TYPE?

Notes:	Changes to this parameter will not be applied until Update Changes command is sent. See “ RB Parameter Manager (Downlink) ” on page 915 section for more details.
Dependencies:	Always grayed out since this instrument supports only one RF input.
Preset:	QPSK
State Saved:	Saved in instrument state.
Range:	QPSK 16QAM 64QAM
Initial S/W Revision:	A.03.00
Help Map ID:	0

QPSK

Selects QPSK for the Modulation Type for all the Allocations when Mod Type Couple is On.

Key Path:	Meas Setup, Chan Profile Setup, Edit User Mapping, Mod Type
Mode:	LTE, LTETDD
Initial S/W Revision:	Prior to A.02.00
Modified at S/W Revision:	A.03.00
Help Map ID:	29356

16QAM

Selects 16QAM for the Modulation Type for all the Allocations when Mod Type Couple is On.

Key Path:	Meas Setup, Chan Profile Setup, Edit User Mapping, Mod Type
Mode:	LTE, LTETDD
Initial S/W Revision:	Prior to A.02.00
Modified at S/W Revision:	A.03.00
Help Map ID:	29165

64QAM

Selects 64QAM for the Modulation Type for all the Allocations when Mod Type Couple is On.

Key Path:	Meas Setup, Chan Profile Setup, Edit User Mapping, Mod Type
Mode:	LTE, LTETDD
Initial S/W Revision:	Prior to A.02.00
Modified at S/W Revision:	A.03.00
Help Map ID:	29357

LTE Modulation Analysis Measurement
Meas Setup (Measurement Setup)

Mod Type Couple

Determines whether or not all the Allocations will use the Common Mod Type value.

Key Path:	Meas Setup, Chan Profile Setup, Edit User Mapping, Mod Type
Mode:	LTE, LTETDD
Remote Command:	[:SENSe] :EVM:DLINK:PROFile:USER<n>:PDSCh:MODulation:TYPE:COUPle OFF ON 0 1 [:SENSe] :EVM:DLINK:PROFile:USER<n>:PDSCh:MODulation:TYPE:COUPle?
Example:	EVM:DLIN:PROF:USER1:PDSC:MOD:TYPE:COUP ON EVM:DLIN:PROF:USER1:PDSC:MOD:TYPE:COUP?
Notes:	Changes to this parameter will not be applied until Update Changes command is sent. See “RB Parameter Manager (Downlink)” on page 915 section for more details.
Dependencies:	The range of sub op code <n> values is determined by the number of Users the user has configured. Max value for n=50. If the user attempts to remotely set or query a sub op code that is out of range, this will result in an error message. Enabled when Detection is Manual and Codeword 0 Enable is ON.
Preset:	ON
State Saved:	Saved in instrument state.
Initial S/W Revision:	Prior to A.02.00
Modified at S/W Revision:	A.03.00
Help Map ID:	29203

Mod Type Couple for Codeword 1

Determines whether or not all the Allocations will use the Common Mod Type value for Codeword 1.

Key Path:	Meas Setup, Chan Profile Setup, Edit User Mapping, Mod Type
Mode:	LTE, LTETDD
Remote Command:	[:SENSe] :EVM:DLINK:PROFile:USER<n>:PDSCh:CWONe:MODulation:TYPE:COUPle OFF ON 0 1 [:SENSe] :EVM:DLINK:PROFile:USER<n>:PDSCh:CWONe:MODulation:TYPE:COUPle?
Example:	EVM:DLIN:PROF:USER1:PDSC:CWON:MOD:TYPE:COUP ON EVM:DLIN:PROF:USER1:PDSC:CWON:MOD:TYPE:COUP?

Notes:	Changes to this parameter will not be applied until Update Changes command is sent. See “RB Parameter Manager (Downlink)” on page 915 section for more details.
Dependencies:	Always grayed out since this instrument supports only one RF input.
Preset:	ON
State Saved:	Saved in instrument state.
Initial S/W Revision:	A.03.00
Help Map ID:	0

PDSCH Common Power Boost

See [Edit User Mapping \(Downlink\)@29198](#).

Key Path:	Meas Setup, Chan Profile Setup, Edit User Mapping
Help Map ID:	29379

Common EPRE

Sets the EPRE value for all the Allocations when EPRE Couple is On.

The average power per antenna port is relative to the 0 dB level of the RS power when its value is 0 dB.

Key Path:	Meas Setup, Chan Profile Setup, Edit User Mapping
Mode:	LTE, LTETDD
Remote Command:	[:SENSE] :EVM:DLINK:PROfile:USER<n>:PDSch:EPRE <rel_ampl> [:SENSE] :EVM:DLINK:PROfile:USER<n>:PDSch:EPRE?
Example:	EVM:DLIN:PROF:USER1:PDSC:EPRE 0 EVM:DLIN:PROF:USER1:PDSC:EPRE?
Notes:	Changes to this parameter will not be applied until Update Changes command is sent. See Section “RB Parameter Manager (Downlink)” on page 915, “RB Parameter Manager (Downlink)” on page 915 section for more details.
Dependencies:	The range of sub op code <n> values is determined by the number of Users the user has configured Max value for n=50. If the user attempts to remotely set or query a sub op code that is out of range, this will result in an error message. Enabled when Detection is Manual, EPRE Couple is ON, and Use “Per Antenna” EPRE is On.
Preset:	0 dB
State Saved:	Saved in instrument state.

LTE Modulation Analysis Measurement
Meas Setup (Measurement Setup)

Min:	-100 dB
Max:	100 dB
Initial S/W Revision:	A.11.00
Help Map ID:	40957

Auto Detect PDSCH QPSK for EPRE

Sets the EPRE value for PDSCH QPSK Mod Type when Detection is Auto and Use “Per Antenna” EPRE is On.

Key Path:	Meas Setup, Chan Profile Setup, Edit User Mapping, tab
Mode:	LTE, LTETDD
Remote Command:	[:SENSe] :EVM:DLINk:PROFile:AUTO:PDSC:h:QPSK:EPRE <rel_ampl> [:SENSe] :EVM:DLINk:PROFile:AUTO:PDSC:h:QPSK:EPRE?
Example:	EVM:DLIN:PROF:AUTO:PDSC:QPSK:EPRE 0 EVM:DLIN:PROF:AUTO:PDSC:QPSK:EPRE?
Notes:	Changes to this parameter will not be applied until Update Changes command is sent. See Section “ RB Parameter Manager (Downlink) ” on page 915, “ RB Parameter Manager (Downlink) ” on page 915 section for more details.
Dependencies:	Enabled when Detection is Auto, and Use “Per Antenna” EPRE is On.
Preset:	0
State Saved:	Saved in instrument state.
Min:	-100
Max:	100
Initial S/W Revision:	A.11.00
Help Map ID:	0

Auto Detect PDSCH 16QAM for EPRE

Sets the EPRE value for PDSCH 16QAM Mod Type when Detection is Auto, and Use “Per Antenna” EPRE is On.

Key Path:	Meas Setup, Chan Profile Setup, Edit User Mapping, tab
Mode:	LTE, LTETDD
Remote Command:	[:SENSe] :EVM:DLINk:PROFile:AUTO:PDSC:h:QAM16:EPRE <rel_ampl> [:SENSe] :EVM:DLINk:PROFile:AUTO:PDSC:h:QAM16:EPRE?
Example:	EVM:DLIN:PROF:AUTO:PDSC:QAM16:EPRE 0 EVM:DLIN:PROF:AUTO:PDSC:QAM16:EPRE?

Notes:	Changes to this parameter will not be applied until Update Changes command is sent. See Section “ RB Parameter Manager (Downlink) ” on page 915, “ RB Parameter Manager (Downlink) ” on page 915 section for more details.
Dependencies:	Enabled when Detection is Auto, and Use “Per Antenna” EPRE is On.
Preset:	0
State Saved:	Saved in instrument state.
Min:	-100
Max:	100
Initial S/W Revision:	A.11.00
Help Map ID:	0

Auto Detect PDSCH 64QAM for EPRE

Sets the EPRE value for PDSCH 64QAM Mod Type when Detection is Auto, and Use “Per Antenna” EPRE is On.

Key Path:	Meas Setup, Chan Profile Setup, Edit User Mapping, tab
Mode:	LTE, LTETDD
Remote Command:	[:SENSE] :EVM:DLINK:PROF:le:AUTO:PDSC:h:QAM64 :EPRE <rel_ampl> [:SENSE] :EVM:DLINK:PROF:le:AUTO:PDSC:h:QAM64 :EPRE?
Example:	EVM:DLIN:PROF:AUTO:PDSC:QAM64:EPRE 0 EVM:DLIN:PROF:AUTO:PDSC:QAM64:EPRE?
Notes:	Changes to this parameter will not be applied until Update Changes command is sent. See Section “ RB Parameter Manager (Downlink) ” on page 915, “ RB Parameter Manager (Downlink) ” on page 915 section for more details.
Dependencies:	Enabled when Detection is Auto Auto , and Use “Per Antenna” EPRE is On.
Preset:	0
State Saved:	Saved in instrument state.
Min:	-100
Max:	100
Initial S/W Revision:	A.11.00
Help Map ID:	0

Common Power Boost for Codeword 0

Sets the Power Boost value for all the Allocations when Power Boost Couple is On.

Power Boost value specifies the average power for the codeword symbols.

The average power of the codeword modulation symbols (d(q)(i)) is relative to the 0 dB level determined by the RS

LTE Modulation Analysis Measurement
Meas Setup (Measurement Setup)

power level.

Key Path:	Meas Setup, Chan Profile Setup, Edit User Mapping, Power Boost
Mode:	LTE, LTETDD
Remote Command:	[:SENSe] :EVM:DLINk:PROFile:USER<n>:PDSCh:PWRBoost <rel_ampl> [:SENSe] :EVM:DLINk:PROFile:USER<n>:PDSCh:PWRBoost?
Example:	EVM:DLIN:PROF:USER1:PDSC:PWRB 0 EVM:DLIN:PROF:USER1:PDSC:PWRB?
Notes:	Changes to this parameter will not be applied until Update Changes command is sent. See “RB Parameter Manager (Downlink)” on page 915 section for more details.
Dependencies:	The range of sub op code <n> values is determined by the number of Users the user has configured Max value for n=50. If the user attempts to remotely set or query a sub op code that is out of range, this will result in an error message. Enabled when Detection is Manual, Use "Per-antenna" EPRE is OFF, Power Boost Couple is ON, and Codeword 0 Enable is ON.
Preset:	0 dB
State Saved:	Saved in instrument state.
Min:	-100 dB
Max:	100 dB
Initial S/W Revision:	Prior to A.02.00
Modified at S/W Revision:	A.03.00, A.04.20
Help Map ID:	29204

Auto Detect PDSCH QPSK Power Boost

Sets the Power Boost value for PDSCH QPSK Mod Type when Detection is Auto.

Key Path:	Meas Setup, Chan Profile Setup, Edit User Mapping, tab
Mode:	LTE, LTETDD
Remote Command:	[:SENSe] :EVM:DLINk:PROFile:AUTO:PDSCh:QPSK:PWRBoost <rel_ampl> [:SENSe] :EVM:DLINk:PROFile:AUTO:PDSCh:QPSK:PWRBoost?
Example:	EVM:DLIN:PROF:AUTO:PDSC:QPSK:PWRB 0 EVM:DLIN:PROF:AUTO:PDSC:QPSK:PWRB?

Notes:	Changes to this parameter will not be applied until Update Changes command is sent. See “RB Parameter Manager (Downlink)” on page 915 section for more details.
Dependencies:	Enabled when Detection is Auto, Use "Per-antenna" EPRE is OFF and Auto Detect Codeword 0 for QPSK QAM16 QAM64 is ON.
Preset:	0
State Saved:	Saved in instrument state.
Min:	-100
Max:	100
Initial S/W Revision:	A.03.00, A.04.20
Help Map ID:	0

Auto Detect PDSCH 16QAM Power Boost

Sets the Power Boost value for PDSCH 16QAM Mod Type when Detection is Auto.

Key Path:	Meas Setup, Chan Profile Setup, Edit User Mapping, tab
Mode:	LTE, LTETDD
Remote Command:	[:SENSE] :EVM:DLINK:PROFile:AUTO:PDSC:h:QAM16:PWRBoost <rel_ampl> [:SENSE] :EVM:DLINK:PROFile:AUTO:PDSC:h:QAM16:PWRBoost?
Example:	EVM:DLIN:PROF:AUTO:PDSC:QAM16:PWRB 0 EVM:DLIN:PROF:AUTO:PDSC:QAM16:PWRB?
Notes:	Changes to this parameter will not be applied until Update Changes command is sent. See “RB Parameter Manager (Downlink)” on page 915 section for more details.
Dependencies:	Enabled when Detection is Auto, Use "Per-antenna" EPRE is OFF and Auto Detect Codeword 0 for QPSK QAM16 QAM64 is ON.
Preset:	0
State Saved:	Saved in instrument state.
Min:	-100
Max:	100
Initial S/W Revision:	A.03.00, A.04.20
Help Map ID:	0

Auto Detect PDSCH 64QAM Power Boost

Sets the Power Boost value for PDSCH 64QAM Mod Type when Detection is Auto.

Key Path:	Meas Setup, Chan Profile Setup, Edit User Mapping, tab
Mode:	LTE, LTETDD
Remote Command:	[:SENSe] :EVM:DLINk:PROFile:AUTO:PDSC:h:QAM64:PWRBoost <rel_ampl> [:SENSe] :EVM:DLINk:PROFile:AUTO:PDSC:h:QAM64:PWRBoost?
Example:	EVM:DLIN:PROF:AUTO:PDSC:QAM64:PWRB 0 EVM:DLIN:PROF:AUTO:PDSC:QAM64:PWRB?
Notes:	Changes to this parameter will not be applied until Update Changes command is sent. See “RB Parameter Manager (Downlink)” on page 915 section for more details.
Dependencies:	Enabled when Detection is Auto, Use "Per-antenna" EPRE is OFF and Auto Detect Codeword 0 for QPSK QAM16 QAM64 is ON.
Preset:	0
State Saved:	Saved in instrument state.
Min:	-100
Max:	100
Initial S/W Revision:	A.03.00, A.04.20
Help Map ID:	0

Common Power Boost for Codeword 1

Sets the Power Boost value for Codeword 1 for all the Allocations when Power Boost Couple is On.

Key Path:	Meas Setup, Chan Profile Setup, Edit User Mapping, Power Boost
Mode:	LTE, LTETDD
Remote Command:	[:SENSe] :EVM:DLINk:PROFile:USER<n>:PDSC:h:CWONe:PWRBoost <rel_ampl> [:SENSe] :EVM:DLINk:PROFile:USER<n>:PDSC:h:CWONe:PWRBoost? ?
Example:	EVM:DLIN:PROF:USER1:PDSC:CWON:PWRB 0 EVM:DLIN:PROF:USER1:PDSC:CWON:PWRB?
Notes:	Changes to this parameter will not be applied until Update Changes command is sent. See “RB Parameter Manager (Downlink)” on page 915 section for more details.
Dependencies:	Always grayed out since this instrument supports only one RF input.

Preset:	0 dB
State Saved:	Saved in instrument state.
Min:	-100 dB
Max:	100 dB
Initial S/W Revision:	A.03.00, A.04.20
Help Map ID:	40767

Auto Detect PDSCH QPSK Power Boost for Codeword 1

Sets the Power Boost value for PDSCH QPSK Mod Type for Codeword 1 when Detection is Auto.

Key Path:	Meas Setup, Chan Profile Setup, Edit User Mapping, tab
Mode:	LTE, LTETDD
Remote Command:	[:SENSe] :EVM:DLINk:PROFile:AUTO:PDSC:h:QPSK:CWONe:PWRBoo st <rel_ampl> [:SENSe] :EVM:DLINk:PROFile:AUTO:PDSC:h:QPSK:CWONe:PWRBoo st?
Example:	EVM:DLIN:PROF:AUTO:PDSC:QPSK:CWON:PWRB 0 EVM:DLIN:PROF:AUTO:PDSC:QPSK:CWON:PWRB?
Notes:	Changes to this parameter will not be applied until Update Changes command is sent. See “RB Parameter Manager (Downlink)” on page 915 section for more details.
Dependencies:	Always grayed out since this instrument supports only one RF input.
Preset:	0
State Saved:	Saved in instrument state.
Min:	-100
Max:	100
Initial S/W Revision:	A.03.00, A.04.20
Help Map ID:	0

Auto Detect PDSCH 16QAM Power Boost for Codeword 1

Sets the Power Boost value for PDSCH 16QAM Mod Type for Codeword 1 when Detection is Auto.

Key Path:	Meas Setup, Chan Profile Setup, Edit User Mapping, tab
Mode:	LTE, LTETDD

LTE Modulation Analysis Measurement
Meas Setup (Measurement Setup)

Remote Command:	[:SENSe] :EVM:DLINk:PROFile:AUTO:PDSC:h:QAM16:CWONe:PWRBo ost <rel_amp1> [:SENSe] :EVM:DLINk:PROFile:AUTO:PDSC:h:QAM16:CWONe:PWRBo ost?
Example:	EVM:DLIN:PROF:AUTO:PDSC:QAM16:CWON:PWRB 0 EVM:DLIN:PROF:AUTO:PDSC:QAM16:CWON:PWRB?
Notes:	Changes to this parameter will not be applied until Update Changes command is sent. See “RB Parameter Manager (Downlink)” on page 915 section for more details.
Dependencies:	Always grayed out since this instrument supports only one RF input.
Preset:	0
State Saved:	Saved in instrument state.
Min:	-100
Max:	100
Initial S/W Revision:	A.03.00, A.04.20
Help Map ID:	0

Auto Detect PDSCH 64QAM Power Boost for Codeword 1

Sets the Power Boost value for PDSCH 64QAM Mod Type for Codeword 1 when Detection is Auto.

Key Path:	Meas Setup, Chan Profile Setup, Edit User Mapping, tab
Mode:	LTE, LTETDD
Remote Command:	[:SENSe] :EVM:DLINk:PROFile:AUTO:PDSC:h:QAM64:CWONe:PWRBo ost <rel_amp1> [:SENSe] :EVM:DLINk:PROFile:AUTO:PDSC:h:QAM64:CWONe:PWRBo ost?
Example:	EVM:DLIN:PROF:AUTO:PDSC:QAM64:CWON:PWRB 0 EVM:DLIN:PROF:AUTO:PDSC:QAM64:CWON:PWRB?
Notes:	Changes to this parameter will not be applied until Update Changes command is sent. See “RB Parameter Manager (Downlink)” on page 915 section for more details.
Dependencies:	Always grayed out since this instrument supports only one RF input.
Preset:	0
State Saved:	Saved in instrument state.
Min:	-100
Max:	100

Initial S/W Revision:	A.03.00, A.04.20
Help Map ID:	0

Decoded EPRE

Sets the EPRE value for the specified user.

Key Path:	Meas Setup, Chan Profile Setup, Edit User Mapping, EPRE
Mode:	LTE, LTETDD
Remote Command:	[:SENSE] :EVM:DLINK:PROFile:USER<n>:DECoded:PDSCh:EPRE <rel_ampl> [:SENSE] :EVM:DLINK:PROFile:USER<n>:DECoded:PDSCh:EPRE?
Example:	EVM:DLIN:PROF:USER1:DEC:PDSCh:EPRE 0 EVM:DLIN:PROF:USER1:DEC:PDSCh:EPRE?
Notes:	Changes to this parameter will not be applied until Update Changes command is sent. See Section “RB Parameter Manager (Downlink)” on page 915 , “RB Parameter Manager (Downlink)” on page 915 section for more details.
Dependencies:	The range of sub op code <n> values is determined by the number of Users the user has configured Max value for n=50. If the user attempts to remotely set or query a sub op code that is out of range, this will result in an error message. Available when all the following conditions are met. Direction is Downlink. Detection is Auto. RB Auto Detect Mode is Decoded PDCCH. Use “Per Antenna” EPRE is On. Auto-detect Power Levels is Off.
Preset:	0 dB
State Saved:	Saved in instrument state.
Min:	-100 dB
Max:	100 dB
Initial S/W Revision:	A.11.00
Help Map ID:	40958

Decoded User Power Boost for Codeword 0

Sets the Power Boost value for the specified user.

Key Path:	Meas Setup, Chan Profile Setup, Edit User Mapping, Power Boost
-----------	---

LTE Modulation Analysis Measurement
Meas Setup (Measurement Setup)

Mode:	LTE, LTETDD
Remote Command:	[:SENSe] :EVM:DLINK:PROFile:USER<n>:DECoded:PDSC:CWZero :PWRBoost <rel_ampl> [:SENSe] :EVM:DLINK:PROFile:USER<n>:DECoded:PDSC:CWZero :PWRBoost?
Example:	EVM:DLIN:PROF:USER1:DEC:PDSC:CWZ:PWRB 0 EVM:DLIN:PROF:USER1:DEC:PDSC:CWZ:PWRB?
Notes:	Changes to this parameter will not be applied until Update Changes command is sent. See “RB Parameter Manager (Downlink)” on page 915 section for more details.
Dependencies:	The range of sub op code <n> values is determined by the number of Users the user has configured Max value for n=50. If the user attempts to remotely set or query a sub op code that is out of range, this will result in an error message. Available when all the following conditions are met. Direction is Downlink. Detection is Auto. RB Auto Detect Mode is Decoded PDCCH. Auto-detect Power Levels is OFF. Use "Pre-antenna" EPRE is OFF. Codeword 0 Enable for Decoded User is ON.
Preset:	0 dB
State Saved:	Saved in instrument state.
Min:	-100 dB
Max:	100 dB
Initial S/W Revision:	A.06.00
Help Map ID:	29219

Decoded User Power Boost for Codeword 1

Sets the Power Boost value for the specified user.

Key Path:	Meas Setup, Chan Profile Setup, Edit User Mapping, Power Boost
Mode:	LTE, LTETDD
Remote Command:	[:SENSe] :EVM:DLINK:PROFile:USER<n>:DECoded:PDSC:CWONE :PWRBoost <rel_ampl> [:SENSe] :EVM:DLINK:PROFile:USER<n>:DECoded:PDSC:CWONE :PWRBoost?

Example:	EVM:DLIN:PROF:USER1:DEC:PDSC:CWON:PWRB 0
Notes:	Changes to this parameter will not be applied until Update Changes command is sent. See “RB Parameter Manager (Downlink)” on page 915 section for more details.
Dependencies:	<p>The range of sub op code <n> values is determined by the number of Users the user has configured Max value for n=50.</p> <p>If the user attempts to remotely set or query a sub op code that is out of range, this will result in an error message.</p> <p>Available when all the following conditions are met.</p> <p>Direction is Downlink.</p> <p>Detection is Auto.</p> <p>RB Auto Detect Mode is Decoded PDCCH.</p> <p>Auto-detect Power Levels is OFF.</p> <p>Use "Pre-antenna" EPRE is OFF.</p> <p>Codeword 1 Enable for Decoded User is ON.</p>
Preset:	0 dB
State Saved:	Saved in instrument state.
Min:	-100 dB
Max:	100 dB
Initial S/W Revision:	A.06.00
Help Map ID:	29220

Power Boost Couple

Determines whether or not all the Allocations will use the Common Power Boost value.

Key Path:	Meas Setup, Chan Profile Setup, Edit User Mapping, Power Boost
Mode:	LTE, LTETDD
Remote Command:	<pre>[:SENSE] :EVM:DLINK:PROFile:USER<n>:PDSC:h:PWRBoost:COUPL e OFF ON 0 1 [:SENSE] :EVM:DLINK:PROFile:USER<n>:PDSC:h:PWRBoost:COUPL e?</pre>
Example:	<p>EVM:DLIN:PROF:USER1:PDSC:PWRB:COUP 0</p> <p>EVM:DLIN:PROF:USER1:PDSC:PWRB:COUP?</p>
Notes:	Changes to this parameter will not be applied until Update Changes command is sent. See “RB Parameter Manager (Downlink)” on page 915 section for more details.

LTE Modulation Analysis Measurement
Meas Setup (Measurement Setup)

Dependencies:	The range of sub op code <n> values is determined by the number of Users the user has configured. Max value for n=50. If the user attempts to remotely set or query a sub op code that is out of range, this will result in an error message. Enabled when Detection is Manual, Use "Per-antenna" EPRE is OFF and Codeword 0 Enable is ON.
Preset:	ON
State Saved:	Saved in instrument state.
Initial S/W Revision:	Prior to A.02.00
Modified at S/W Revision:	A.03.00
Help Map ID:	29205

Couple for EPRE

Determines whether or not all the Allocations will use the EPRE value.

Key Path:	Meas Setup, Chan Profile Setup, Edit User Mapping
Mode:	LTE, LTETDD
Remote Command:	[:SENSE] :EVM:DLINK:PROF:USER<n>:PDSCh:EPRE:COUPLE OFF ON 0 1 [:SENSE]:EVM:DLINK:PROF:USER<n>:PDSCh:EPRE:COUPLE?
Example:	EVM:DLIN:PROF:USER1:PDSCh:EPRE:COUP 0 EVM:DLIN:PROF:USER1:PDSCh:EPRE:COUP?
Notes:	Changes to this parameter will not be applied until Update Changes command is sent. See Section “RB Parameter Manager (Downlink)” on page 915 , “RB Parameter Manager (Downlink)” on page 915 section for more details.
Dependencies:	The range of sub op code <n> values is determined by the number of Users the user has configured. Max value for n=50. If the user attempts to remotely set or query a sub op code that is out of range, this will result in an error message. Enabled when Use “Per Antenna” EPRE is On and Detection is Manual.
Preset:	ON
State Saved:	Saved in instrument state.
Initial S/W Revision:	A.11.00
Help Map ID:	40959

Power Boost Couple for Codeword 1

Determines whether or not all the Allocations will use the Common Power Boost value for Codeword 1.

Key Path:	Meas Setup, Chan Profile Setup, Edit User Mapping, Power Boost
Mode:	LTE, LTETDD
Remote Command:	[:SENSE] :EVM:DLINK:PROFile:USER<n>:PDSCh:CWONe:PWRBoost :COUPle OFF ON 0 1 [:SENSE] :EVM:DLINK:PROFile:USER<n>:PDSCh:CWONe:PWRBoost :COUPle?
Example:	EVM:DLIN:PROF:USER1:PDSC:CWON:PWRB:COUP 0 EVM:DLIN:PROF:USER1:PDSC:CWON:PWRB:COUP?
Notes:	Changes to this parameter will not be applied until Update Changes command is sent. See “RB Parameter Manager (Downlink)” on page 915 section for more details.
Dependencies:	Always grayed out since this instrument supports only one RF input.
Preset:	ON
State Saved:	Saved in instrument state.
Initial S/W Revision:	A.03.00
Help Map ID:	40774

Codeword

Enables Codeword 0 and Codeword 1.

Key Path:	Meas Setup, Chan Profile Setup, Edit User Mapping
Help Map ID:	40873

Codeword 0 Enable

Enables parameters for Codeword 0 and includes Codeword 0 in the analysis when Detection is Manual.

Key Path:	Meas Setup, Chan Profile Setup, Edit User Mapping
Mode:	LTE, LTETDD
Remote Command:	[:SENSE] :EVM:DLINK:PROFile:USER1 50:PDSCh:CWZero:ENABLE ON OFF 0 1 [:SENSE] :EVM:DLINK:PROFile:USER1 50:PDSCh:CWZero:ENABLE ?
Example:	EVM:DLIN:PROF:USER1:PDSC:CWZ:ENAB ON EVM:DLIN:PROF:USER1:PDSC:CWZ:ENAB?

LTE Modulation Analysis Measurement
Meas Setup (Measurement Setup)

Notes:	Changes to this parameter will not be applied until Update Changes command is sent. See “ RB Parameter Manager (Downlink) ” on page 915 section for more details.
Dependencies:	Enabled when Detection is Manual.
Preset:	ON
State Saved:	Saved in instrument state.
Initial S/W Revision:	A.03.00
Help Map ID:	40775

Auto Detect Codeword 0 Enable for QPSK

Enables parameters for Codeword 0 for QPSK modulation when Detection is Auto.

Key Path:	Meas Setup, Chan Profile Setup, Edit User Mapping
Mode:	LTE, LTETDD
Remote Command:	[:SENSe] :EVM:DLINk:PROFile:AUTO:PDSCh:QPSK:CWZero:ENABLe ON OFF 0 1 [:SENSe] :EVM:DLINk:PROFile:AUTO:PDSCh:QPSK:CWZero:ENABLe?
Example:	EVM:DLIN:PROF:AUTO:PDSCh:QPSK:CWZ:ENAB ON EVM:DLIN:PROF:AUTO:PDSCh:QPSK:CWZ:ENAB?
Notes:	Changes to this parameter will not be applied until Update Changes command is sent. See “ RB Parameter Manager (Downlink) ” on page 915 section for more details.
Dependencies:	Enabled when Detection is Auto.
Preset:	ON
State Saved:	Saved in instrument state.
Initial S/W Revision:	A.03.00
Help Map ID:	0

Auto Detect Codeword 0 Enable for 16QAM

Enables parameters for Codeword 0 for 16QAM modulation when Detection is Auto.

Key Path:	Meas Setup, Chan Profile Setup, Edit User Mapping
Mode:	LTE, LTETDD
Remote Command:	[:SENSe] :EVM:DLINk:PROFile:AUTO:PDSCh:QAM16:CWZero:ENABLe ON OFF 0 1 [:SENSe] :EVM:DLINk:PROFile:AUTO:PDSCh:QAM16:CWZero:ENABLe?

Example:	EVM:DLIN:PROF:AUTO:PDSC:QAM16:CWZ:ENAB ON EVM:DLIN:PROF:AUTO:PDSC:QAM16:CWZ:ENAB?
Notes:	Changes to this parameter will not be applied until Update Changes command is sent. See “RB Parameter Manager (Downlink)” on page 915 section for more details.
Dependencies:	Enabled when Detection is Auto.
Preset:	ON
State Saved:	Saved in instrument state.
Initial S/W Revision:	A.03.00
Help Map ID:	0

Auto Detect Codeword 0 Enable for 64QAM

Enables parameters for Codeword 0 for 64QAM modulation when Detection is Auto.

Key Path:	Meas Setup, Chan Profile Setup, Edit User Mapping
Mode:	LTE, LTETDD
Remote Command:	[:SENSe] :EVM:DLINk:PROFile:AUTO:PDSC:QAM64:CWZero:ENABle ON OFF 0 1 [:SENSe] :EVM:DLINk:PROFile:AUTO:PDSC:QAM64:CWZero:ENABle?
Example:	EVM:DLIN:PROF:AUTO:PDSC:QAM64:CWZ:ENAB ON EVM:DLIN:PROF:AUTO:PDSC:QAM64:CWZ:ENAB?
Notes:	Changes to this parameter will not be applied until Update Changes command is sent. See “RB Parameter Manager (Downlink)” on page 915 section for more details.
Dependencies:	Enabled when Detection is Auto.
Preset:	ON
State Saved:	Saved in instrument state.
Initial S/W Revision:	A.03.00
Help Map ID:	0

Codeword 1 Enable

Enables parameters for Codeword 1 and includes Codeword 1 in the analysis when Detection is Manual.

Key Path:	Meas Setup, Chan Profile Setup, Edit User Mapping
Mode:	LTE, LTETDD

LTE Modulation Analysis Measurement
Meas Setup (Measurement Setup)

Remote Command:	[:SENSE] :EVM:DLINK:PROF:USER1 50 :PDSCh: CWONe: ENABLe ON OFF 0 1 [:SENSE] :EVM:DLINK:PROF:USER1 50 :PDSCh: CWONe: ENABLe?
Example:	EVM:DLIN:PROF:USER1:PDSC:CWON ON
Notes:	Changes to this parameter will not be applied until Update Changes command is sent. See “ RB Parameter Manager (Downlink) ” on page 915 section for more details.
Dependencies:	Always grayed out since this instrument supports only one RF input.
Preset:	ON
State Saved:	Saved in instrument state.
Initial S/W Revision:	A.03.00
Help Map ID:	40779

Auto Detect Codeword 1 Enable for QPSK

Enables parameters for Codeword 1 for QPSK modulation when Detection is Auto.

Key Path:	Meas Setup, Chan Profile Setup, Edit User Mapping
Mode:	LTE, LTETDD
Remote Command:	[:SENSE] :EVM:DLINK:PROF:AUTO: PDSCh: QPSK: CWONe: ENABLe ON OFF 0 1 [:SENSE] :EVM:DLINK:PROF:AUTO: PDSCh: QPSK: CWONe: ENABLe ?
Example:	EVM:DLIN:PROF:AUTO:PDSC:QPSK:CWON:ENAB ON EVM:DLIN:PROF:AUTO:PDSC:QPSK:CWON:ENAB?
Notes:	Changes to this parameter will not be applied until Update Changes command is sent. See “ RB Parameter Manager (Downlink) ” on page 915 section for more details.
Dependencies:	Always grayed out since this instrument supports only one RF input.
Preset:	ON
State Saved:	Saved in instrument state.
Initial S/W Revision:	A.03.00
Help Map ID:	0

Auto Detect Codeword 1 Enable for 16QAM

Enables parameters for Codeword 1 for 16QAM modulation when Detection is Auto.

Key Path:	Meas Setup, Chan Profile Setup, Edit User Mapping
-----------	--

Mode:	LTE, LTETDD
Remote Command:	[:SENSe] :EVM:DLINk:PROFile:AUTO:PDSC:h:QAM16:CWONe:ENABLe ON OFF 0 1 [:SENSe] :EVM:DLINk:PROFile:AUTO:PDSC:h:QAM16:CWONe:ENABLe?
Example:	EVM:DLIN:PROF:AUTO:PDSC:QAM16:CWON:ENAB ON EVM:DLIN:PROF:AUTO:PDSC:QAM16:CWON:ENAB?
Notes:	Changes to this parameter will not be applied until Update Changes command is sent. See “RB Parameter Manager (Downlink)” on page 915 section for more details.
Dependencies:	Always grayed out since this instrument supports only one RF input.
Preset:	ON
State Saved:	Saved in instrument state.
Initial S/W Revision:	A.03.00
Help Map ID:	0

Auto Detect Codeword 1 Enable for 64QAM

Enables parameters for Codeword 1 for 64QAM modulation when Detection is Auto.

Key Path:	Meas Setup, Chan Profile Setup, Edit User Mapping
Mode:	LTE, LTETDD
Remote Command:	[:SENSe] :EVM:DLINk:PROFile:AUTO:PDSC:h:QAM64:CWONe:ENABLe ON OFF 0 1 [:SENSe] :EVM:DLINk:PROFile:AUTO:PDSC:h:QAM64:CWONe:ENABLe?
Example:	EVM:DLIN:PROF:AUTO:PDSC:QAM64:CWON:ENAB ON EVM:DLIN:PROF:AUTO:PDSC:QAM64:CWON:ENAB?
Notes:	Changes to this parameter will not be applied until Update Changes command is sent. See “RB Parameter Manager (Downlink)” on page 915 section for more details.
Dependencies:	Always grayed out since this instrument supports only one RF input.
Preset:	ON
State Saved:	Saved in instrument state.
Initial S/W Revision:	A.03.00
Help Map ID:	0

LTE Modulation Analysis Measurement
Meas Setup (Measurement Setup)

Codeword 0 Enable for Decoded User

Enables parameters for Codeword 0 and includes Codeword 0 in the analysis.

Key Path:	Meas Setup, Chan Profile Setup, Edit User Mapping
Mode:	LTE, LTETDD
Remote Command:	[:SENSe] :EVM:DLINK:PROFile:USER<n>:DECoded:PDSC:CWZero :ENABle ON OFF 0 1 [:SENSe] :EVM:DLINK:PROFile:USER<n>:DECoded:PDSC:CWZero :ENABle?
Example:	EVM:DLIN:PROF:USER1:DEC:PDSC:CWZ:ENAB ON EVM:DLIN:PROF:USER1:DEC:PDSC:CWZ:ENAB?
Notes:	Changes to this parameter will not be applied until Update Changes command is sent. See “RB Parameter Manager (Downlink)” on page 915 section for more details.
Dependencies:	Available when Detection is Auto, RB Auto Detect Mode is Decoded PDCCH and Auto Detect Power Levels is Off.
Preset:	ON
State Saved:	Saved in instrument state.
Range:	On Off
Initial S/W Revision:	A.06.00
Help Map ID:	29239

Codeword 1 Enable for Decoded User

Enables parameters for Codeword 1 and includes Codeword 1 in the analysis.

Key Path:	Meas Setup, Chan Profile Setup, Edit User Mapping
Mode:	LTE, LTETDD
Remote Command:	[:SENSe] :EVM:DLINK:PROFile:USER<n>:DECoded:PDSC:CWONE : ENABle ON OFF 0 1 [:SENSe] :EVM:DLINK:PROFile:USER<n>:DECoded:PDSC:CWONE : ENABle?
Example:	EVM:DLIN:PROF:USER1:DEC:PDSC:CWON:ENAB ON EVM:DLIN:PROF:USER1:DEC:PDSC:CWON:ENAB?
Notes:	Changes to this parameter will not be applied until Update Changes command is sent. See “RB Parameter Manager (Downlink)” on page 915 section for more details.
Dependencies:	Available when Detection is Auto, RB Auto Detect Mode is Decoded PDCCH, and Auto-detect Power Levels is Off.

Preset:	ON
State Saved:	Saved in instrument state.
Range:	On Off
Initial S/W Revision:	A.06.00
Help Map ID:	29240

Common Frame Index

Select the Frame Index for all the Allocations when Frame Index Couple is On.

Key Path:	Meas Setup, Chan Profile Setup, Edit User Mapping, Frame Index
Mode:	LTETDD
Remote Command:	[:SENSE] :EVM:DLINK:PROfile:USER<n>:PDSch:FINDex F0 F1 [:SENSE] :EVM:DLINK:PROfile:USER<n>:PDSch:FINDex?
Example:	EVM:DLIN:PROF:USER1:PDSC:FIND F0 EVM:DLIN:PROF:USER1:PDSC:FIND?
Notes:	Changes to this parameter will not be applied until Update Changes command is sent. See “RB Parameter Manager (Downlink)” on page 915 section for more details.
Dependencies:	The range of sub op code <n> values is determined by the number of Users the user has configured. Max value for n= 50 If the user attempts to remotely set or query a sub op code that is out of range, this will result in an error message. Enabled when all the following conditions are met. Detection is Manual. Multi-Frame Analysis is ON. Frame Index Couple is ON.
Preset:	F0
State Saved:	Saved in instrument state.
Range:	F0 F1
Initial S/W Revision:	Prior to A.02.00
Modified at S/W Revision:	A.03.00
Help Map ID:	40783

LTE Modulation Analysis Measurement
Meas Setup (Measurement Setup)

Frame 0

Selects Frame 0 for the Frame Index for all the Allocations when Frame Index Couple is On.

Key Path:	Meas Setup, Chan Profile Setup, Edit User Mapping, Frame Index
Mode:	LTETDD
Initial S/W Revision:	Prior to A.02.00
Modified at S/W Revision:	A.03.00
Help Map ID:	40784

Frame 1

Selects Frame 1 for the Frame Index for all the Allocations when Frame Index Couple is On.

Key Path:	Meas Setup, Chan Profile Setup, Edit User Mapping, Frame Index
Mode:	LTETDD
Initial S/W Revision:	Prior to A.02.00
Modified at S/W Revision:	A.03.00
Help Map ID:	40785

Frame Index Couple

Sets all the Allocations to use the Common Frame Index value.

Key Path:	Meas Setup, Chan Profile Setup, Edit User Mapping, Frame Index
Mode:	LTETDD
Remote Command:	[:SENSE] :EVM:DLINK:PROF:USER<n>:PDSch:FINDEX:COUPLE OFF ON 0 1 [:SENSE] :EVM:DLINK:PROF:USER<n>:PDSch:FINDEX:COUPLE?
Example:	EVM:DLIN:PROF:USER1:PDSC:FIND:COUP ON EVM:DLIN:PROF:USER1:PDSC:FIND:COUP?
Notes:	Changes to this parameter will not be applied until Update Changes command is sent. See “RB Parameter Manager (Downlink)” on page 915 section for more details.
Dependencies:	The range of sub op code <n> values is determined by the number of Users the user has configured. Max value for n=50. If the user attempts to remotely set or query a sub op code that is out of range, this will result in an error message. Enabled when the Mode is LTE TDD, Detection is Manual, and Multi-Frame Analysis is ON.
Preset:	ON

State Saved:	Saved in instrument state.
Initial S/W Revision:	Prior to A.02.00
Modified at S/W Revision:	A.03.00
Help Map ID:	40857

Add User

Adds a new User and the new entry becomes the selected User. The new User will contain as default one Allocation that has the associated parameters set to the default values.

Key Path:	Meas Setup, Chan Profile Setup, Edit User Mapping, PDSCH
Mode:	LTE, LTETDD
Remote Command:	[:SENSe] :EVM:DLINk:PROFile:ADD:USER
Example:	EVM:DLIN:PROF:ADD:USER
Notes:	Changes to this parameter will not be applied until Update Changes command is sent. See “RB Parameter Manager (Downlink)” on page 915 section for more details.
Dependencies:	The new User will be added at the end of the currently defined Users. Disabled once the number of Users reaches to 50, the max number.
Initial S/W Revision:	Prior to A.02.00
Modified at S/W Revision:	A.03.00
Help Map ID:	29157

Delete User

Deletes the current selected User.

Key Path:	Meas Setup, Chan Profile Setup, Edit User Mapping, PDSCH
Mode:	LTE, LTETDD
Remote Command:	[:SENSe] :EVM:DLINk:PROFile:USER<n>:DELeTe
Example:	EVM:DLIN:PROF:USER1:DEL
Notes:	Changes to this parameter will not be applied until Update Changes command is sent. See “RB Parameter Manager (Downlink)” on page 915 section for more details.
Dependencies:	Disabled when there is only one User. The range of sub op code <n> values is determined by the number of Users the user has configured. If the user attempts to remotely delete a sub op code that is out of range, this will result in an error message.
Initial S/W Revision:	Prior to A.02.00

LTE Modulation Analysis Measurement
Meas Setup (Measurement Setup)

Modified at S/W Revision:	A.03.00
Help Map ID:	29158

Precoding Parameters

Sets up precoding parameters for PDSCH.

Key Path:	Meas Setup, Chan Profile Setup, Edit User Mapping
Help Map ID:	40874

Precoding

Selects the Precoding method for each User when Detection is Manual.

This parameter specifies the type of MIMO precoding performed on the current user's data. The possible choices are Off, Transmit Diversity (TxDiv) and Spatial Multiplexing (SpMux).

- OFF - Off
- TXDiversity - Tx Diversity
- SMULTiplex - Spatial Multiplexing

When SpMux is selected, the parameters Number of Layers, Number of Codewords, CDD, and Codebook Index must also be specified.

NOTE RB Auto Detection can detect allocations of either SpMux or TxDiv, but not both. When Detection is Auto, this parameter determines which type of Precoding the demodulator looks for.

Key Path:	Meas Setup, Chan Profile Setup, Edit User Mapping
Mode:	LTE, LTETDD
Remote Command:	[:SENSe] :EVM:DLINk:PROFile:USER1 50 :PDSCh:PRECoding OFF TXDiversity SMULTiplex [:SENSe] :EVM:DLINk:PROFile:USER1 50 :PDSCh:PRECoding?
Example:	EVM:DLIN:PROF:USER1:PDSC:PREC TXD EVM:DLIN:PROF:USER1:PDSC:PREC?
Notes:	Changes to this parameter will not be applied until Update Changes command is sent. See “RB Parameter Manager (Downlink)” on page 915 section for more details.
Dependencies:	Enabled when Detection is Manual and Number of Tx Antenna is set to more than 1.
Preset:	TXDiversity
State Saved:	Saved in instrument state.
Range:	Off Tx Diversity Spatial Multiplexing

Initial S/W Revision:	A.03.00
Modified at S/W Revision:	A.10.00
Help Map ID:	40789

Auto Detect Precoding

Selects the Precoding method when Detection is Auto.

Key Path:	Meas Setup, Chan Profile Setup, Edit User Mapping
Mode:	LTE, LTETDD
Remote Command:	[:SENSe] :EVM:DLINk:PROFile:AUTO:PDSC:PRECoding OFF TXDiversity SMULtiplex [:SENSe] :EVM:DLINk:PROFile:AUTO:PDSC:PRECoding?
Example:	EVM:DLIN:PROF:AUTO:PDSC:PREC TXD EVM:DLIN:PROF:AUTO:PDSC:PREC?
Notes:	Changes to this parameter will not be applied until Update Changes command is sent. See “RB Parameter Manager (Downlink)” on page 915 section for more details.
Dependencies:	Enabled when Detection is Auto, Detection Mode is Power Based, and Number of Tx Antenna is set to more than 1.
Preset:	TXDiversity
State Saved:	Saved in instrument state.
Range:	Off Tx Diversity Spatial Multiplexing
Initial S/W Revision:	A.03.00
Modified at S/W Revision:	A.10.00
Help Map ID:	0

Number of Layers

Sets the number of layers when Detection is Manual.

Key Path:	Meas Setup, Channel Profile Setup, Edit User Mapping
Mode:	LTE, LTETDD
Remote Command:	[:SENSe] :EVM:DLINk:PROFile:USER1 50:PDSC:NLAYers <integer> [:SENSe] :EVM:DLINk:PROFile:USER1 50:PDSC:NLAYers?
Example:	EVM:DLIN:PROF:USER1:PDSC:NLAY 1 EVM:DLIN:PROF:USER1:PDSC:NLAY?

LTE Modulation Analysis Measurement
Meas Setup (Measurement Setup)

Notes:	Changes to this parameter will not be applied until Update Changes command is sent. See “RB Parameter Manager (Downlink)” on page 915 section for more details. Always 1 since this instrument supports only one RF input.
Dependencies:	Enabled only when Detection is Manual, Number of Tx Antenna is more than 1 and Precoding is set to Spatial Multiplexing.
Couplings:	Coupled with Number of Tx Antenna, Precoding.
Preset:	1
State Saved:	Saved in instrument state.
Min:	1
Max:	4
Initial S/W Revision:	A.03.00
Help Map ID:	40791

Auto Detect Number of Layers

Sets the number of layers when Detection is Auto.

Key Path:	Meas Setup, Channel Profile Setup, Edit User Mapping
Mode:	LTE, LTETDD
Remote Command:	[:SENSE] :EVM:DLINK:PROFile:AUTO:PDSCh:NLAYers <integer> [:SENSE] :EVM:DLINK:PROFile:AUTO:PDSCh:NLAYers?
Example:	EVM:DLIN:PROF:AUTO:PDSCh:NLAY 1 EVM:DLIN:PROF:AUTO:PDSCh:NLAY?
Notes:	Changes to this parameter will not be applied until Update Changes command is sent. See “RB Parameter Manager (Downlink)” on page 915 section for more details. Always 1 since this instrument supports only one RF input.
Dependencies:	Enabled only when Detection is Auto, Number of Tx Antenna is more than 1 and Auto Detect Precoding is set to Spatial Multiplexing.
Couplings:	Coupled with Number of Tx Antenna, Precoding
Preset:	1
State Saved:	Saved in instrument state.
Min:	1
Max:	4
Initial S/W Revision:	A.03.00

Help Map ID:	0
--------------	---

Number of Codewords

Sets the number of codewords when Detection is Manual.

Key Path:	Meas Setup, Channel Profile Setup, Edit User Mapping
Mode:	LTE, LTETDD
Remote Command:	[:SENSe] :EVM:DLINk:PROFile:USER1 50 :PDSCh:NCODewords <integer> [:SENSe] :EVM:DLINk:PROFile:USER1 50 :PDSCh:NCODewords?
Example:	EVM:DLIN:PROF:USER1:PDSC:NCOD 1 EVM:DLIN:PROF:USER1:PDSC:NCOD?
Notes:	Changes to this parameter will not be applied until Update Changes command is sent. See “RB Parameter Manager (Downlink)” on page 915 section for more details.
Dependencies:	Always grayed out since this instrument supports only one RF input.
Couplings:	Coupled with Precoding.
Preset:	1
State Saved:	Saved in instrument state.
Min:	1
Max:	2
Initial S/W Revision:	A.03.00
Help Map ID:	40793

Auto Detect Number of Codewords

Sets the number of codewords when Detection is Auto.

Key Path:	Meas Setup, Channel Profile Setup, Edit User Mapping
Mode:	LTE, LTETDD
Remote Command:	[:SENSe] :EVM:DLINk:PROFile:AUTO: PDSCh:NCODewords <integer> [:SENSe] :EVM:DLINk:PROFile:AUTO: PDSCh:NCODewords?
Example:	EVM:DLIN:PROF:AUTO:PDSC:NCOD 1 EVM:DLIN:PROF:AUTO:PDSC:NCOD?
Notes:	Changes to this parameter will not be applied until Update Changes command is sent. See “RB Parameter Manager (Downlink)” on page 915 section for more details.

LTE Modulation Analysis Measurement
Meas Setup (Measurement Setup)

Dependencies:	Always grayed out since this instrument supports only one RF input.
Couplings:	Coupled with Precoding
Preset:	1
State Saved:	Saved in instrument state.
Min:	1
Max:	2
Initial S/W Revision:	A.03.00
Help Map ID:	0

Precoding CDD

Sets whether precoding will be done without cyclic delay diversity (CDD) or with large delay CDD for spatial multiplexing when Detection is Manual.

Key Path:	Meas Setup, Channel Profile Setup, Edit User Mapping
Mode:	LTE, LTETDD
Remote Command:	[:SENSe] :EVM:DLINk:PROFile:USER1 50 :PDSC: CDD WOCDD LDCDD [:SENSe] :EVM:DLINk:PROFile:USER1 50 :PDSC: CDD?
Example:	EVM:DLIN:PROF:USER1:PDSC:CDD WOCDD EVM:DLIN:PROF:USER1:PDSC:CDD?
Notes:	Changes to this parameter will not be applied until Update Changes command is sent. See “RB Parameter Manager (Downlink)” on page 915 section for more details.
Dependencies:	Always grayed out since this instrument supports only one RF input.
Preset:	WOCDD
State Saved:	Saved in instrument state.
Range:	Without CDD Large Delay CDD
Initial S/W Revision:	A.03.00
Help Map ID:	40795

Auto Detect Precoding CDD

Determines whether precoding will be done without cyclic delay diversity (CDD) or with large delay CDD for spatial multiplexing when Detection is Auto.

Key Path:	Meas Setup, Channel Profile Setup, Edit User Mapping
Mode:	LTE, LTETDD

Remote Command:	[:SENSE] :EVM:DLINK:PROFile:AUTO:PDSC:h:CDD WOCDD LDCDD [:SENSE] :EVM:DLINK:PROFile:AUTO:PDSC:h:CDD?
Example:	EVM:DLIN:PROFile:AUTO:PDSC:CDD WOCDD EVM:DLIN:PROFile:AUTO:PDSC:CDD?
Notes:	Changes to this parameter will not be applied until Update Changes command is sent. See “RB Parameter Manager (Downlink)” on page 915 section for more details.
Dependencies:	Always grayed out since this instrument supports only one RF input.
Preset:	WOCDD
State Saved:	Saved in instrument state.
Range:	Without CDD Large Delay CDD
Initial S/W Revision:	A.03.00
Help Map ID:	0

Codebook Index

Sets the Codebook Index number for spatial multiplexing precoding when Detection is Manual.

Key Path:	Meas Setup, Channel Profile Setup, Edit User Mapping
Mode:	LTE, LTETDD
Remote Command:	[:SENSE] :EVM:DLINK:PROFile:USER1 50:PDSC:h:CBIndex <integer> [:SENSE] :EVM:DLINK:PROFile:USER1 50:PDSC:h:CBIndex?
Example:	EVM:DLIN:PROF:USER1:PDSC:CBIN 1 EVM:DLIN:PROF:USER1:PDSC:CBIN?
Notes:	Changes to this parameter will not be applied until Update Changes command is sent. See “RB Parameter Manager (Downlink)” on page 915 section for more details.
Dependencies:	Max value of this parameter depends on Number of Tx Antenna. When Number of Tx Antenna is set to 2, Max value is 3. When Number of Tx Antenna is set to 4, Max value is 15. Enabled only when Detection is Manual, Number of Tx Antenna is set to more than 1, and Precoding is set to Spatial Multiplexing.
Couplings:	Coupled with Number of Tx Antenna
Preset:	0
State Saved:	Saved in instrument state.
Min:	0

LTE Modulation Analysis Measurement
Meas Setup (Measurement Setup)

Max:	3 - when Number of Tx Antenna is set to 2 15 - when Number of Tx Antenna is set to 4
Initial S/W Revision:	A.03.00
Help Map ID:	40797

Auto Detect Codebook Index

Sets the Codebook Index number for spatial multiplexing precoding when Detection is Auto.

Key Path:	Meas Setup, Channel Profile Setup, Edit User Mapping
Mode:	LTE, LTETDD
Remote Command:	[:SENSE] :EVM:DLINK:PROFile:AUTO:PDSC:CBINdex <integer> [:SENSE] :EVM:DLINK:PROFile:AUTO:PDSC:CBINdex?
Example:	EVM:DLIN:PROF:AUTO:PDSC:CBIN 1 EVM:DLIN:PROF:AUTO:PDSC:CBIN?
Notes:	Changes to this parameter will not be applied until Update Changes command is sent. See “RB Parameter Manager (Downlink)” on page 915 section for more details.
Dependencies:	Max value of this parameter depends on Number of Tx Antenna. When Number of Tx Antenna is set to 2, Max value is 3. When Number of Tx Antenna is set to 4, Max value is 15. Enabled only when Detection is Auto, Precoding is set to Spatial Multiplexing and Number of Tx Antenna is set to more than 1.
Couplings:	Coupled with Number of Tx Antenna
Preset:	0
State Saved:	Saved in instrument state.
Min:	0
Max:	3 - when Number of Tx Antenna is set to 2 15 - when Number of Tx Antenna is set to 4
Initial S/W Revision:	A.03.00
Help Map ID:	0

OK/Cancel

Displays a menu that enables the changes to the parameters on the dialog to be applied or cancelled.

Mode:	LTE, LTETDD
Initial S/W Revision:	Prior to A.02.00

Modified at S/W Revision:	A.03.00
Help Map ID:	29195

OK

Applies all changes made to the parameters on the dialog then exits the dialog.

Mode:	LTE, LTETDD
Initial S/W Revision:	Prior to A.02.00
Modified at S/W Revision:	A.03.00
Help Map ID:	29196

Cancel

Cancels all changes made to the parameters on the dialog then exits the dialog.

Mode:	LTE, LTETDD
Initial S/W Revision:	Prior to A.02.00
Modified at S/W Revision:	A.03.00
Help Map ID:	29197

RB Parameter Manager (Downlink)

Reduces the time it takes to configure channel profile related parameters with SCPI commands.

The SCPI command parameters shown below are managed in this scheme.

Note that changes to the parameters are not applied until the Update Changes command is sent. See [“Update Changes \(Downlink\)” on page 918](#) section for more details.

[[:SENSe]:EVM:DLINK:PROFile:ADD:USER
[[:SENSe]:EVM:DLINK:PROFile:AUTO:PDSCh:CBIndex
[[:SENSe]:EVM:DLINK:PROFile:AUTO:PDSCh:CDD
[[:SENSe]:EVM:DLINK:PROFile:AUTO:PDSCh:NCODewords
[[:SENSe]:EVM:DLINK:PROFile:AUTO:PDSCh:NLAYers
[[:SENSe]:EVM:DLINK:PROFile:AUTO:PDSCh:PRECoding
[[:SENSe]:EVM:DLINK:PROFile:AUTO:PDSCh:QAM16:CWONe:ENABLE
[[:SENSe]:EVM:DLINK:PROFile:AUTO:PDSCh:QAM16:CWONe:PWRBoost
[[:SENSe]:EVM:DLINK:PROFile:AUTO:PDSCh:QAM16:CWZero:ENABLE
[[:SENSe]:EVM:DLINK:PROFile:AUTO:PDSCh:QAM16:PWRBoost
[[:SENSe]:EVM:DLINK:PROFile:AUTO:PDSCh:QAM64:CWONe:ENABLE

LTE Modulation Analysis Measurement
Meas Setup (Measurement Setup)

[[:SENSe]:EVM:DLINK:PROFile:AUTO:PDSC:h:QAM64:CWONe:PWRBoost
[[:SENSe]:EVM:DLINK:PROFile:AUTO:PDSC:h:QAM64:CWZero:ENABle
[[:SENSe]:EVM:DLINK:PROFile:AUTO:PDSC:h:QAM64:PWRBoost
[[:SENSe]:EVM:DLINK:PROFile:AUTO:PDSC:h:QPSK:CWONe:ENABle
[[:SENSe]:EVM:DLINK:PROFile:AUTO:PDSC:h:QPSK:CWONe:PWRBoost
[[:SENSe]:EVM:DLINK:PROFile:AUTO:PDSC:h:QPSK:CWZero:ENABle
[[:SENSe]:EVM:DLINK:PROFile:AUTO:PDSC:h:QPSK:PWRBoost
[[:SENSe]:EVM:DLINK:PROFile:EPRE:PA NTenna
[[:SENSe]:EVM:DLINK:PROFile:USER1 50:PDSC:h:RBALloc1 250:EPRE
[[:SENSe]:EVM:DLINK:PROFile:USER1 50:PDSC:h:EPRE:COUPle
[[:SENSe]:EVM:DLINK:PROFile:USER1 50:PDSC:h:EPRE
[[:SENSe]:EVM:DLINK:PROFile:AUTO:PDSC:h:QPSK:EPRE
[[:SENSe]:EVM:DLINK:PROFile:AUTO:PDSC:h:QAM16:EPRE
[[:SENSe]:EVM:DLINK:PROFile:AUTO:PDSC:h:QAM64:EPRE
[[:SENSe]:EVM:DLINK:PROFile:USER1 50:DECoded:PDSC:h:EPRE
[[:SENSe]:EVM:DLINK:PROFile:PBCH:PWRBoost
[[:SENSe]:EVM:DLINK:PROFile:PCFich:PWRBoost
[[:SENSe]:EVM:DLINK:PROFile:PDCC:h:ALLocation:AUTO:DETect
[[:SENSe]:EVM:DLINK:PROFile:PDCC:h:ALLocation:CONStant
[[:SENSe]:EVM:DLINK:PROFile:PDCC:h:ALLocation:SUBFrame(0:9):SYMBols
[[:SENSe]:EVM:DLINK:PROFile:PDCC:h:PWRBoost
[[:SENSe]:EVM:DLINK:PROFile:PDCC:h:PWRBoost:STEP <rel_ampl>
[[:SENSe]:EVM:DLINK:PROFile:PHIC:h:ALLocation:RATIo
[[:SENSe]:EVM:DLINK:PROFile:PHIC:h:DESPread
[[:SENSe]:EVM:DLINK:PROFile:PHIC:h:DURation
[[:SENSe]:EVM:DLINK:PROFile:PHIC:h:PWRBoost
[[:SENSe]:EVM:DLINK:PROFile:PHIC:h:PWRBoost:STEP
[[:SENSe]:EVM:DLINK:PROFile:PSS:PWRBoost
[[:SENSe]:EVM:DLINK:PROFile:RS:PWRBoost
[[:SENSe]:EVM:DLINK:PROFile:SSS:PWRBoost
[[:SENSe]:EVM:DLINK:PROFile:PRS:ACTive
[[:SENSe]:EVM:DLINK:PROFile:PRS:PWRBoost

[[:SENSe]:EVM:DLINK:PROFile:PRS:INDex
[[:SENSe]:EVM:DLINK:PROFile:PRS:SUBFrame:NUMBer
[[:SENSe]:EVM:DLINK:PROFile:MBSFn:ACTive
[[:SENSe]:EVM:DLINK:PROFile:MBSFn:AID
[[:SENSe]:EVM:DLINK:PROFile:MBSFn:NMRLength
[[:SENSe]:EVM:DLINK:PROFile:MBSFn:PWRBoost
[[:SENSe]:EVM:DLINK:PROFile:MBSFn:SUBFrame(1:4,6:9): ACTive
[[:SENSe]:EVM:DLINK:PROFile:AUTO:PMCH:PWRBoost
[[:SENSe]:EVM:DLINK:PROFile:PMCH:SUBFrame(1:4,6:9):ACTive
[[:SENSe]:EVM:DLINK:PROFile:PMCH:SUBFrame(1:4,6:9):PWRBoost
[[:SENSe]:EVM:DLINK:PROFile:PMCH:SUBFrame(1:4,6:9):MODulation:TYPE
[[:SENSe]:EVM:DLINK:PROFile:USER(1:50):DECoded:PDSCh:CWZero:PWRBoost
[[:SENSe]:EVM:DLINK:PROFile:USER(1:50):DECoded:PDSCh:CWONe:ENABLE
[[:SENSe]:EVM:DLINK:PROFile:USER(1:50):DECoded:PDSCh:CWONe:PWRBoost
[[:SENSe]:EVM:DLINK:PROFile:USER(1:50):DELete
[[:SENSe]:EVM:DLINK:PROFile:USER(1:50):PDSCh:ADD:ALLocation
[[:SENSe]:EVM:DLINK:PROFile:USER(1:50):PDSCh:RBALloc(1:50):CWONe:MODulation:TYPE
[[:SENSe]:EVM:DLINK:PROFile:USER(1:50):PDSCh:RBALloc(1:50):CWONe:PWRBoost
[[:SENSe]:EVM:DLINK:PROFile:USER(1:50):PDSCh:RBALloc(1:50):DELete
[[:SENSe]:EVM:DLINK:PROFile:USER(1:50):PDSCh:RBALloc(1:50):MODulation:TYPE
[[:SENSe]:EVM:DLINK:PROFile:USER(1:50):PDSCh:RBALloc(1:50):PWRBoost
[[:SENSe]:EVM:DLINK:PROFile:USER(1:50):PDSCh:RBALloc(1:50):RB:END
[[:SENSe]:EVM:DLINK:PROFile:USER(1:50):PDSCh:RBALloc(1:50):RB:STARt
[[:SENSe]:EVM:DLINK:PROFile:USER(1:50):PDSCh:RBALloc(1:50):SLOT:END
[[:SENSe]:EVM:DLINK:PROFile:USER(1:50):PDSCh:RBALloc(1:50):SLOT:STARt
[[:SENSe]:EVM:DLINK:PROFile:USER(1:50):PDSCh:CBINdex
[[:SENSe]:EVM:DLINK:PROFile:USER(1:50):PDSCh:CDD
[[:SENSe]:EVM:DLINK:PROFile:USER(1:50):PDSCh:CWONe:ENABLE
[[:SENSe]:EVM:DLINK:PROFile:USER(1:50):PDSCh:CWONe:MODulation:TYPE
[[:SENSe]:EVM:DLINK:PROFile:USER(1:50):PDSCh:CWONe:MODulation:TYPE:COUPle
[[:SENSe]:EVM:DLINK:PROFile:USER(1:50):PDSCh:CWONe:PWRBoost
[[:SENSe]:EVM:DLINK:PROFile:USER(1:50):PDSCh:CWONe:PWRBoost:COUPle

LTE Modulation Analysis Measurement
Meas Setup (Measurement Setup)

[[:SENSe]:EVM:DLINK:PROFile:USER(1:50):PDSCh:CWZero:ENABle
[[:SENSe]:EVM:DLINK:PROFile:USER(1:50):PDSCh:MODulation:TYPE
[[:SENSe]:EVM:DLINK:PROFile:USER(1:50):PDSCh:MODulation:TYPE:COUple
[[:SENSe]:EVM:DLINK:PROFile:USER(1:50):PDSCh:NCODewords
[[:SENSe]:EVM:DLINK:PROFile:USER(1:50):PDSCh:NLAYers
[[:SENSe]:EVM:DLINK:PROFile:USER(1:50):PDSCh:PRECoding
[[:SENSe]:EVM:DLINK:PROFile:USER(1:50):PDSCh:PWRBoost
[[:SENSe]:EVM:DLINK:PROFile:USER(1:50):PDSCh:PWRBoost:COUple
[[:SENSe]:EVM:DLINK:PROFile:USER(1:50):RNTI
[[:SENSe]:EVM:DLINK:PROFile:USER(1:50):UERS:ACTive
[[:SENSe]:EVM:DLINK:PROFile:USER(1:50):UERS:PWRBoost

This feature supports following operations:

- “[Update Changes \(Downlink\)](#)” on page 918 command, which applies pending changes to parameters.
- “[Ignore Changes \(Downlink\)](#)” on page 919 command, which discards pending changes to parameters.
- “[Clear Changes \(Downlink\)](#)” on page 919 command, which clears all existing RB mapping information for downlink.

The Update Changes and Ignore Changes commands behave similarly to the OK and Cancel buttons on user interface dialogs, respectively.

For example, to clear existing RB mapping information and configure one user with one allocation with RB End set to 49, send the following sequence in order. Note that the Clear Changes command is not required just after mode preset since there is no RB mapping information by default.

```
[[:SENSe]:EVM:DLINK:PROFile:CLEAR
[:SENSe]:EVM:DLINK:PROFile:ADD:USER
[:SENSe]:EVM:DLINK:PROFile:USER1:PDSCh:ADD:ALlocation
[:SENSe]:EVM:DLINK:PROFile:USER1:PDSCh:RBALloc1:RB:END 49
[:SENSe]:EVM:DLINK:PROFile:UPDate
```

Update Changes (Downlink)

SCPI Only. This command updates changes sent after last UPDate or preset.

Mode:	LTE, LTETDD
Remote Command:	[[:SENSe]:EVM:DLINK:PROFile:UPDate
Example:	EVM:DLIN:PROF:UPD

Initial S/W Revision:	A.03.00
Help Map ID:	0

Clear Changes (Downlink)

SCPI Only. This command clears allocated resource blocks and deletes all Users.

Mode:	LTE, LTETDD
Remote Command:	[:SENSe] :EVM:DLINk:PROFile:CLEar
Example:	EVM:DLIN:PROF:CLE
Initial S/W Revision:	A.03.00
Help Map ID:	0

Ignore Changes (Downlink)

SCPI Only. This command ignores (clears) changes which are not updated.

Mode:	LTE, LTETDD
Remote Command:	[:SENSe] :EVM:DLINk:PROFile:IGNore
Example:	EVM:DLIN:PROF:IGN
Initial S/W Revision:	A.03.00
Help Map ID:	0

Count Number of Users (Downlink)

SCPI Only. This command returns the number of added users.

Mode:	LTE, LTETDD
Remote Command:	[:SENSe] :EVM:DLINk:PROFile:COUNt?
Example:	EVM:DLIN:PROF:COUN?
Initial S/W Revision:	A.03.00
Help Map ID:	0

Count Number of PDSCH Allocations (Downlink)

SCPI Only. This command returns the number of added PDSCH allocations.

Mode:	LTE, LTETDD
Remote Command:	[:SENSe] :EVM:DLINk:PROFile:USER<n>:PDSCh:COUNt?
Example:	EVM:DLIN:PROF:USER2:PDSC:COUN?

LTE Modulation Analysis Measurement
Meas Setup (Measurement Setup)

Dependencies:	The range of sub op code <n> values is determined by the number of Users the user has configured. If the user attempts to remotely set or query a sub op code that is out of range, this will result in an error message.
Initial S/W Revision:	A.03.00
Help Map ID:	0

Copy Auto -> Manual

Copies all autodetected allocations into the Resource Block Editor.

For downlink, when Copy Auto -> Manual is pressed, each autodetected modulation group will be assigned to a user. When RB Auto Detect Mode is set to Power Based, User_01 will contain resource blocks with QPSK; User_02 will contain resource blocks with 16QAM; and User_03 will contain resource blocks with 64QAM.

When RB Auto Detect Mode is set to Decode PDCCH, the user allocations will be copied into the LTE Allocation Editor as manual allocations.

For uplink, when Copy Auto -> Manual is pressed, User_01, which contains all autodetected channels, will be copied into the LTE Allocation Editor.

This key is useful when you have two signals with identical allocations, where one has a fairly good SNR, but the other has a low SNR. In this case, RB Auto Detect may detect the allocations for the noisy signal incorrectly. To work around this, you can recall the clean signal, autodetect allocations, and press Copy Auto -> Manual. Then you can recall the noisy signal and don't need to rely on auto detection.

Note that existing manual user mappings will be overwritten when you press this button.

Key Path:	Meas Setup, Chan Profile Setup
Mode:	LTE, LTETDD
Remote Command:	[:SENSE] :EVM:PROFile:COpy[:IMMediate]
Example:	EVM:PROF:COpy
Notes:	Available when Detection is Auto.
Initial S/W Revision:	A.06.00
Help Map ID:	29241

Chan Profile Setup (Uplink)

Displays a menu of commonly used channel profile setup parameters when Direction is set to Uplink.

Key Path:	Meas Setup
Mode:	LTE, LTETDD
Initial S/W Revision:	Prior to A.02.00

Modified at S/W Revision:	A.03.00
Help Map ID:	29152

Detection

See [Detection@29131@i](#).

Key Path:	Meas Setup, Chan Profile Setup
Help Map ID:	Use 29131

Auto Detect Power Levels

Selects whether or not power levels are auto detected when Direction is Uplink.

When this parameter is set to on, the LTE demodulator will detect the relative uplink channel power levels for PUCCH, PUSCH, SRS and PRACH. When this parameter is set to off, the power levels for uplink channels will need to be specified.

Key Path:	Meas Setup, Chan Profile Setup
Mode:	LTE, LTETDD
Remote Command:	[:SENSE] :EVM:ULINK:PROFile:AUTO[:DETect]:POWER OFF ON 0 1 [:SENSE] :EVM:ULINK:PROFile:AUTO[:DETect]:POWER?
Example:	EVM:ULIN:PROF:AUTO:POW ON EVM:ULIN:PROF:AUTO:POW?
Dependencies:	Available when Direction is Uplink and Detection is Auto.
Preset:	OFF
State Saved:	Saved in instrument state.
Range:	On Off
Initial S/W Revision:	A.10.00
Help Map ID:	40770

Include Non Allocation

Includes inactive signals in the results.

Please refer to [“Include Non Allocation” on page 801](#) for more details.

Key Path:	Meas Setup, Chan Profile Setup
Mode:	LTE, LTETDD

LTE Modulation Analysis Measurement
Meas Setup (Measurement Setup)

Help Map ID:	29359
--------------	-------

Composite Include (Uplink)

Displays a menu that enables inclusion or exclusion of all channels.

Key Path:	Meas Setup, Chan Profile Setup
Mode:	LTE, LTETDD
Initial S/W Revision:	Prior to A.02.00
Modified at S/W Revision:	A.03.00
Help Map ID:	29207

Include All

Turns On all Uplink channels.

Key Path:	Meas Setup, Chan Profile Setup, Composite Include
Mode:	LTE, LTETDD
Remote Command:	[:SENSe] :EVM:ULINK:PROF:INCLude:ALL
Example:	EVM:ULIN:PROF:INCL:ALL
Initial S/W Revision:	Prior to A.02.00
Modified at S/W Revision:	A.03.00
Help Map ID:	29208

Exclude All

Turns Off all Uplink channels.

Key Path:	Meas Setup, Chan Profile Setup, Composite Include
Mode:	LTE, LTETDD
Remote Command:	[:SENSe] :EVM:ULINK:PROF:EXCLude:ALL
Example:	EVM:ULIN:PROF:EXCLude:ALL

Couplings:	Turns Off the following parameters if its state is On. Include PUSCH Include PUSCH DMRS Include PUCCH Include PUCCH DMRS Include PRACH Include S-RS Include Non Allocation
Initial S/W Revision:	Prior to A.02.00
Modified at S/W Revision:	A.03.00
Help Map ID:	29209

Include Users (Uplink)

Displays a menu that enables you to determine which Uplink channels should be included in the results.

When Include is selected, the channel is displayed on applicable traces and also used in the process of Error Summary calculations. When Exclude is selected, only the Frame Summary trace will display information about this user's channel.

Key Path:	Meas Setup, Chan Profile Setup, Include Users
Mode:	LTE, LTETDD
Couplings:	The Users shown on this softpanel are dependant on the number of Users defined. This menu will only display User1 when Detection is Auto. When Detection is Man, it will display all the defined Users
Initial S/W Revision:	Prior to A.02.00
Modified at S/W Revision:	A.03.00
Help Map ID:	29210

User

Indexes the currently defined Users.

Key Path:	Meas Setup, Chan Profile Setup, Include Users
Mode:	LTE, LTETDD
Dependencies:	Enabled when Detection is Manual.
Couplings:	Max value determined by the number of Uplink Users the user has configured
Preset:	0

LTE Modulation Analysis Measurement
Meas Setup (Measurement Setup)

State Saved:	Saved in instrument state.
Min:	1
Max:	Determined by the number of Uplink Users the user has configured
Initial S/W Revision:	Prior to A.02.00
Modified at S/W Revision:	A.03.00
Help Map ID:	29211

Include PUSCH

Includes PUSCH in the results.

Key Path:	Meas Setup, Chan Profile Setup, Include Users
Mode:	LTE, LTETDD
Remote Command:	[:SENSE] :EVM:ULINK:PROF:USER<n>:PUSCh INCLude EXCLude [:SENSE] :EVM:ULINK:PROF:USER<n>:PUSCh?
Example:	EVM:ULIN:PROF:USER1:PUSC INCL EVM:ULIN:PROF:USER1:PUSC?
Dependencies:	The range of sub op code <n> values is determined by the number of Users the user has configured. If the user attempts to remotely set or query a sub op code that is out of range, this will result in an error message. Disabled when Detection is Auto, PUSCH Active is OFF or no slot is added. Only one user can be included at the same time.
Couplings:	This parameter is set to Exclude when Uplink Exclude All is selected. When this parameter is set to Include, PUSCH of the other users and PRACH of all users are set to Exclude.
Preset:	EXCLude
State Saved:	Saved in instrument state.
Range:	Include Exclude
Initial S/W Revision:	Prior to A.02.00
Modified at S/W Revision:	A.03.00
Help Map ID:	29212

Include Auto Detect PUSCH

Includes Auto Detected PUSCH in the results.

Key Path:	Meas Setup, Chan Profile Setup, Include Users
-----------	--

Mode:	LTE, LTETDD
Remote Command:	[:SENSe] :EVM:ULINk:PROFile:AUTO:PUSCh INCLude EXCLude [:SENSe] :EVM:ULINk:PROFile:AUTO:PUSCh?
Example:	EVM:ULIN:PROF:AUTO:PUSC INCL EVM:ULIN:PROF:AUTO:PUSC?
Dependencies:	Enabled when Detection is Auto and Auto Detect PUSCH Active is ON.
Couplings:	This parameter is set to Exclude when Uplink Exclude All is selected. When this parameter is set to Include, Auto Detect PRACH is set to Exclude.
Preset:	INCLude
State Saved:	Saved in instrument state.
Range:	Include Exclude
Initial S/W Revision:	Prior to A.02.00
Modified at S/W Revision:	A.03.00
Help Map ID:	0

Include PUSCH DMRS

Includes PUSCH DMRS in the results.

Key Path:	Meas Setup, Chan Profile Setup, Include Users
Mode:	LTE, LTETDD
Remote Command:	[:SENSe] :EVM:ULINk:PROFile:USER<n>:PUSCh:DMRS INCLude EXCLude [:SENSe] :EVM:ULINk:PROFile:USER<n>:PUSCh:DMRS?
Example:	EVM:ULIN:PROF:USER1:PUSC:DMRS INCL EVM:ULIN:PROF:USER1:PUSC:DMRS?
Dependencies:	The range of sub op code <n> values is determined by the number of Users the user has configured. If the user attempts to remotely set or query a sub op code that is out of range, this will result in an error message. Enabled when Detection is Manual. Only one user can be included at the same time.
Couplings:	This parameter is set to Exclude when Uplink Exclude All is selected. When this parameter is set to Include, PUSCH DMRS of the other users and PRACH of all users are set to Exclude.
Preset:	EXCLude
State Saved:	Saved in instrument state.

LTE Modulation Analysis Measurement
Meas Setup (Measurement Setup)

Range:	Include Exclude
Initial S/W Revision:	Prior to A.02.00
Modified at S/W Revision:	A.03.00
Help Map ID:	29213

Include Auto Detect PUSCH DMRS

Includes Auto Detected PUSCH DMRS in the results.

Key Path:	Meas Setup, Chan Profile Setup, Include Users
Mode:	LTE, LTETDD
Remote Command:	[:SENSe] :EVM:ULINk:PROFile:AUTO:PUSCh:DMRS INCLude EXCLude [:SENSe] :EVM:ULINk:PROFile:AUTO:PUSCh:DMRS?
Example:	EVM:ULIN:PROF:AUTO:PUSC:DMRS INCL EVM:ULIN:PROF:AUTO:PUSC:DMRS?
Dependencies:	Enabled when Detection is Auto.
Couplings:	This parameter is set to Exclude when Uplink Exclude All is selected. When this parameter is set to Include, Auto Detect PRACH is set to Exclude.
Preset:	INCLude
State Saved:	Saved in instrument state.
Range:	Include Exclude
Initial S/W Revision:	Prior to A.02.00
Modified at S/W Revision:	A.03.00
Help Map ID:	0

Include PUCCH

Includes PUCCH in the results.

Key Path:	Meas Setup, Chan Profile Setup, Include Users
Mode:	LTE, LTETDD
Remote Command:	[:SENSe] :EVM:ULINk:PROFile:USER<n>:PUCCh INCLude EXCLude [:SENSe] :EVM:ULINk:PROFile:USER<n>:PUCCh?
Example:	EVM:ULIN:PROF:USER1:PUCCh INCL EVM:ULIN:PROF:USER1:PUCCh?

Dependencies:	The range of sub op code <n> values is determined by the number of Users the user has configured. If the user attempts to remotely set or query a sub op code that is out of range, this will result in an error message. Enabled when PUCCH Active is ON, one or more slots are added, and Detection is Manual. Only one user can be included at the same time.
Couplings:	This parameter is set to Exclude when Uplink Exclude All is selected. When this parameter is set to Include, PUCCH of another user, PUSCH, PRACH and S-RS are set to Exclude.
Preset:	EXCLude
State Saved:	Saved in instrument state.
Range:	Include Exclude
Initial S/W Revision:	Prior to A.02.00
Modified at S/W Revision:	A.03.00
Help Map ID:	29214

Include Auto Detect PUCCH

Includes Auto Detected PUCCH in the results.

Key Path:	Meas Setup, Chan Profile Setup, Include Users
Mode:	LTE, LTETDD
Remote Command:	[:SENSe] :EVM:ULINk:PROFile:AUTO:PUCCh INCLude EXCLude [:SENSe] :EVM:ULINk:PROFile:AUTO:PUCCh?
Example:	EVM:ULIN:PROF:AUTO:PUCCL INCL EVM:ULIN:PROF:AUTO:PUCCL?
Dependencies:	Enabled when Detection is Auto and Auto Detect PUCCH Active is ON.
Couplings:	This parameter is set to Exclude when Uplink Exclude All is selected. When this parameter is set to Include, Auto Detect PRACH is set to Exclude.
Preset:	EXCLude
State Saved:	Saved in instrument state.
Range:	Include Exclude
Initial S/W Revision:	Prior to A.02.00
Modified at S/W Revision:	A.03.00
Help Map ID:	0

Include PUCCH DMRS

Includes PUCCH DMRS in the results.

Key Path:	Meas Setup, Chan Profile Setup, Include Users
Mode:	LTE, LTETDD
Remote Command:	[:SENSe] :EVM:ULINK:PROFile:USER<n>:PUCCh:DMRS INCLude EXCLude [:SENSe] :EVM:ULINK:PROFile:USER<n>:PUCCh:DMRS?
Example:	EVM:ULIN:PROF:USER1:PUCCh:DMRS INCL EVM:ULIN:PROF:USER1:PUCCh:DMRS?
Dependencies:	The range of sub op code <n> values is determined by the number of Users the user has configured. If the user attempts to remotely set or query a sub op code that is out of range, this will result in an error message. Enabled when Detection is Manual. Only one user can be included at the same time.
Couplings:	This parameter is set to Exclude when Uplink Exclude All is selected. When this parameter is set to Include, PUCCH DMRS of the other users and PRACH of all users are set to Exclude.
Preset:	EXCLude
State Saved:	Saved in instrument state.
Range:	Include Exclude
Initial S/W Revision:	Prior to A.02.00
Modified at S/W Revision:	A.03.00
Help Map ID:	29215

Include Auto Detect PUCCH DMRS

Includes Auto Detected PUSCH DMRS in the results.

Key Path:	Meas Setup, Chan Profile Setup, Include Users
Mode:	LTE, LTETDD
Remote Command:	[:SENSe] :EVM:ULINK:PROFile:AUTO:PUCCh:DMRS INCLude EXCLude [:SENSe] :EVM:ULINK:PROFile:AUTO:PUCCh:DMRS?
Example:	EVM:ULIN:PROF:AUTO:PUCCh:DMRS INCL EVM:ULIN:PROF:AUTO:PUCCh:DMRS?
Dependencies:	Enabled when Detection is Auto.

Couplings:	This parameter is set to Exclude when Uplink Exclude All is selected. When this parameter is set to Include, Auto Detect PRACH is set to Exclude.
Preset:	EXCLude
State Saved:	Saved in instrument state.
Range:	Include Exclude
Initial S/W Revision:	Prior to A.02.00
Modified at S/W Revision:	A.03.00
Help Map ID:	0

Include PRACH

Includes PRACH in the results.

Key Path:	Meas Setup, Chan Profile Setup, Include Users
Mode:	LTE, LTETDD
Remote Command:	[:SENSE] :EVM:ULINK:PROFile:USER<n>:PRACH INCLude EXCLude [:SENSE] :EVM:ULINK:PROFile:USER<n>:PRACH?
Example:	EVM:ULIN:PROF:USER1:PRAC INCL EVM:ULIN:PROF:USER1:PRAC?
Dependencies:	The range of sub op code <n> values is determined by the number of Users the user has configured. If the user attempts to remotely set or query a sub op code that is out of range, this will result in an error message. Enabled when Direction is Manual and PRACH Active is ON.
Couplings:	This parameter is set to Exclude when Uplink Exclude All is selected. When this parameter is set to Include, PUSCH, PUCCH and S-RS are set to Exclude.
Preset:	EXCLude
State Saved:	Saved in instrument state.
Range:	Include Exclude
Initial S/W Revision:	A.03.00
Help Map ID:	40799

Include Auto Detect PRACH

Includes Auto Detected PRACH in the results.

Key Path:	Meas Setup, Chan Profile Setup, Include Users
Mode:	LTE, LTETDD
Remote Command:	[:SENSe] :EVM:ULINk:PROFile:AUTO:PRACH INCLude EXCLude [:SENSe] :EVM:ULINk:PROFile:AUTO:PRACH?
Example:	EVM:ULIN:PROF:AUTO:PRAC INCL EVM:ULIN:PROF:AUTO:PRAC?
Dependencies:	Enabled when Detection is Auto and Auto Detect PRACH Active is ON.
Couplings:	This parameter is set to Exclude when Uplink Exclude All is selected. When this parameter is set to Include, Auto Detect PUCCH, Auto Detect PUSCH and Auto Detect S-RS are set to Exclude.
Preset:	EXCLude
State Saved:	Saved in instrument state.
Range:	Include Exclude
Initial S/W Revision:	A.03.00
Help Map ID:	0

Include S-RS

Includes S-RS in the results.

Key Path:	Meas Setup, Chan Profile Setup, Include Users
Mode:	LTE, LTETDD
Remote Command:	[:SENSe] :EVM:ULINk:PROFile:USER<n>:SRS INCLude EXCLude [:SENSe] :EVM:ULINk:PROFile:USER<n>:SRS?
Example:	EVM:ULIN:PROF:USER1:SRS INCL EVM:ULIN:PROF:USER1:SRS?
Dependencies:	The range of sub op code <n> values is determined by the number of Users the user has configured. If the user attempts to remotely set or query a sub op code that is out of range, this will result in an error message. Enabled when Detection is Manual and S-RS Active is ON.
Couplings:	This parameter is set to Exclude when Uplink Exclude All is selected. When this parameter is set to Include, PRACH is set to Exclude.
Preset:	EXCLude

State Saved:	Saved in instrument state.
Range:	Include Exclude
Initial S/W Revision:	A.03.00
Help Map ID:	40801

Include Auto Detect S-RS

Includes Auto Detected S-RS in the results.

Key Path:	Meas Setup, Chan Profile Setup, Include Users
Mode:	LTE, LTETDD
Remote Command:	[:SENSe] :EVM:ULINk:PROFile:AUTO:SRS INCLude EXCLude [:SENSe] :EVM:ULINk:PROFile:AUTO:SRS?
Example:	EVM:ULIN:PROF:AUTO:SRS INCL EVM:ULIN:PROF:AUTO:SRS?
Dependencies:	Enabled when Detection is Auto and Auto Detect S-RS Active is ON.
Couplings:	This parameter is set to Exclude when Uplink Exclude All is selected. When this parameter is set to Include, Auto Detect PRACH is set to Exclude.
Preset:	EXCLude
State Saved:	Saved in instrument state.
Range:	Include Exclude
Initial S/W Revision:	A.03.00
Help Map ID:	0

Edit User Mapping (Uplink)

Displays the LTE Allocation Editor that enables you to edit the Downlink channel parameters. When a parameter is selected, the corresponding softkeys will appear.

- Use **Tab** key to select a parameter field to edit. The rotary knob can be also used to select a parameter field as it has two functions: value adjustment (default) and field navigation. Use **Enter** key to toggle the function.
- In order to apply or discard changes, select OK button or Cancel button on the editor to show the corresponding softkeys and press either of them. These softkeys also appear by pressing **Cancel (Esc)** key when the active function is disabled.

NOTE

If Help is open when you select this key, the dialog and menu does not appear. Close Help by pressing **Cancel (Esc)**, then select this key. After the menu has changed, press the green **Help** key to see Help for the dialog and keys. Close Help

LTE Modulation Analysis Measurement
Meas Setup (Measurement Setup)

when you are ready to edit the parameters.

Key Path:	Meas Setup, Chan Profile Setup, More
Mode:	LTE, LTETDD
Initial S/W Revision:	Prior to A.02.00
Modified at S/W Revision:	A.03.00, A.06.00
Help Map ID:	29216

This table lists all the parameters available to set up uplink user PUSCH, PUCCH, PRACH and S-RS user Parameters.

Parameter	Description
Detection	<p>When enabled, the demodulator can autodetect PUSCH, PUCCH, PRACH or S-RS when a sync slot is specified. A unique sync slot is necessary for determining the frame boundary, but not for successful demodulation.</p> <p>To specify a unique sync slot for PUSCH, make sure the PUSCH tab is active, then specify the Channel Parameters and Per-slot parameters for the sync slot.</p> <p>To specify a unique slot for PUCCH, make sure the PUCCH tab is active, then specify the Sync Slot number and the Per-subframe parameters for the PUCCH sync slot.</p> <p>To specify a unique slot for S-RS, make sure the S-RS tab is active, then specify the Sync Slot number for the S-RS sync.</p>
Auto Detect Power Levels	Selects whether or not power levels are auto detected. Enabled only when Detection is Auto.
Cell ID	Sets the uplink user's physical-layer Cell ID.
RNTI	Sets the uplink user's radio network temporary identifier.
Frame Number	Sets uplink user's System Frame Number.
Group Hopping	Determines whether group hopping is enabled. This parameter is available to be set only if DMRS Parameters is selected. Enabling group hopping disables sequence hopping.
Seq Hopping	Determines whether sequence hopping is enabled. This parameter is available to be set only if DMRS Parameters is selected. Enabling sequence hopping disables group hopping.
Include PUSCH	When selected, PUSCH for the selected user is displayed on appropriate traces. When cleared, only the “Frame Summary” on page 1157 trace will display information about this user's PUSCH channel.
Include PUCCH	When selected, PUCCH for the selected user is displayed on appropriate traces. When cleared, only the “Frame Summary” on page 1157 trace will display information about this user's PUCCH channel.
Include PRACH	When selected, PRACH for the selected user is displayed on appropriate traces. When cleared, only the “Frame Summary” on page 1157 trace will display information about this user's PRACH.

Include S-RS	When selected, S-RS for the selected user is displayed on appropriate traces. When cleared, only the “Frame Summary” on page 1157 trace will display information about this user's S-RS.
Add	Adds a user allocation.
Delete	Deletes the selected user allocation.
PUSCH Channel Parameters	
DMRS Parameters	Selecting this parameter causes DMRS Group, DMRS Seq, and DMRS Cyclic Shift to be set automatically using the following three parameters.
$n_{\text{DMRS}}(1)$	Specifies the value of $n_{\text{DMRS}}(1)$ used by the selected user mapping.
$n_{\text{DMRS}}(2)$	Specifies the value of $n_{\text{DMRS}}(2)$ used by the selected user mapping.
ΔSS	Specifies the value of ΔSS used by the selected user mapping.
Frequency Hopping	Sets the frequency hopping or disables frequency hopping. This key is used in combination with Frequency Hopping Mode.
Frequency Hopping Mode	Sets the frequency hopping. This key is used in combination with Frequency Hopping.
Hopping Offset	Specifies the value of Hopping Offset ($N_{\text{RB}}^{\text{HO}}$). Hopping Offset is the offset used for PUSCH frequency hopping, expressed in number of resource blocks (set by higher layer). (3GPP TS 36.211 V8.5.0 5.3.4)
Number of Sub-bands	Specifies the value of number of sub-bands (N_{sb}). (3GPP TS 36.211 V8.5.0 5.3.4)
PUSCH Per-Slot Parameters	
Couple	Selecting the checkbox next to a parameter will couple that parameter across all RB allocation groups for a user.
RB Start	Specifies the RB start boundary.
RB End	Specifies the RB end boundary.
Mod Type	Modulation type: QPSK, QAM16, or QAM64.
Power (dB)	Sets the PUCCH average power level relative to the 0 dB point set by the PUCCH DMRS Power.
DMRS Group (u)	Specifies the DMRS Group (u) for a slot.
DMRS Seq (v)	Specifies the DMRS Sequence (v) for a slot.
DMRS Cyclic Shift	Specifies the DMRS Cyclic Shift for a slot.

LTE Modulation Analysis Measurement
Meas Setup (Measurement Setup)

DMRS Power (dB)	Specifies the value to set DMRS Power equal to for a slot. PUSCH power is set relative to the 0 dB point determined by this parameter. For example, setting DMRS Power = 2 dB and PUSCH Power = 0.1 dB means that the demodulator will expect PUSCH average power level to be 1.9 dB below the average DMRS power level.
CUR_TX_NB	CUURRENT_TX_NB specifies whether or not allocation is mirrored.
Add	Adds a slot allocation.
Delete	Deletes the selected slot allocation.
Slot Up	Moves the selected slot allocation up in time (increasing slot number) to the closest available slot allocation for a user.
Slot Down	Moves the selected slot allocation down in time (decreasing slot number) to the closest available slot allocation for a user.
PUCCH Channel Parameters	
DMRS Parameters	Selecting this parameter causes DMRS Group, DMRS Seq, and DMRS Cyclic Shift of PUCCH to be set automatically using the following six parameters.
$N_{RB}(2)$	Specifies the value of $N_{RB}(2)$ used by the selected user mapping, $N_{RB}(2)$ indicates the bandwidth reserved for PUCCH 2/2a/2b, expressed in multiples of $N_{SC}RB$.
$N_{CS}(1)$	Specifies the value of $N_{CS}(1)$ used by the selected user mapping, $N_{CS}(1)$ indicates the number of cyclic shifts used for PUCCH formats 1/1a/1b in a resource block with a mix of formats 1/1a/1b and 2/2a/2b.
$n_{PUCCH}(2)$	Specifies the value of $n_{PUCCH}(2)$ used by the selected user mapping, $n_{PUCCH}(2)$ indicates the resource index for PUCCH formats 2/2a/2b
$shift^{PUCCH}$	Specifies the value of $shift^{PUCCH}$ used by the selected user mapping
Format/ $n_{PUCCH}^{(1)}$	Enables auto detection of PUCCH Format and $n_{PUCCH}(1)$ for all subframes. This is useful when the format and/or $n_{PUCCH}(1)$ value is different for each subframe.
PUCCH Per-Subframe Parameters	

First RB	<p>Sets the RB index of the selected user's PUCCH allocation for this slot. The next or previous (see Notes below) slot's PUCCH allocation will automatically be set according to the LTE standard (mirrored in frequency).</p> <p>For example, in a 5 MHz LTE signal (25 RBs), when Slot 0 contains a PUCCH allocation at RB 0, Slot 1 will be set to have a PUCCH allocation at RB 24.</p> <p>Notes</p> <p>A user can only have one RB allocated to PUCCH per slot.</p> <p>When Auto Detection is selected and Sync Slot is odd, this parameter sets the RB index for the second slot in a PUCCH subframe, causing the previous (instead of the next) slot to contain a mirrored PUCCH allocation for the current user.</p>
Format	Sets the PUCCH type. Supported types are Type1, Type 1a, Type 1b, Type 2, Type 2a, Type 2b, Type 1 Short, Type 1a Short, Type 1b Short.
Cyclic Shift	Sets PUCCH cyclic shift.
OS	Sets the Orthogonal Sequence index for PUCCH.
Power (dB)	Sets the PUCCH average power level relative to the 0 dB point set by the PUCCH DMRS Power.
DMRS Group (u)	Sets the group number for the PUCCH demodulation reference signal (DMRS).
DMRS Power (dB)	<p>Sets the power level for the PUCCH demodulation reference signal (DMRS) during the selected subframe. PUCCH Power is set relative to the 0 dB point determined by this parameter.</p> <p>For example, setting DMRS Power = 2 dB and PUCCH Power = 0.1 dB means that the demodulator will expect PUCCH average power level to be 1.9 dB below the average DMRS power level.</p>
$n_{\text{PUCCH}}(1)$	Specifies the value of $n_{\text{PUCCH}}(1)$ used by the selected user mapping, $n_{\text{PUCCH}}(1)$ indicates the resource index for PUCCH formats 1/1a/1b
Add	Adds a subframe allocation.
Delete	Deletes the selected subframe allocation.
Subframe Up	Moves the selected subframe allocation up in time (increasing subframe number) to the closest available subframe allocation for a user.
Subframe Down	Moves the selected subframe allocation down in time (decreasing subframe number) to the closest available subframe allocation for a user.
PRACH Channel Parameters (3GPP TS 36.211 5.7)	
Resource Block Offset	Sets offset for first physical resource block occupied by PRACH resource considered ($n_{\text{PRB}}^{\text{RA}}$).
Configuration Index	Sets PRACH Configuration Index to give frame structure.

LTE Modulation Analysis Measurement
Meas Setup (Measurement Setup)

Logical Root Seq Index	Sets Logical Root Sequence Index to give root Zadoff-Chu sequence order.
Cyclic Shift Set	Sets Unrestricted or Restricted to give N_{CS} (Number of Cyclic Shifts) for PRACH preamble sequence generation. Value of N_{CS} will be determined by this selection and N_{CS} Configuration.
N_{CS} Configuration	Sets a value to give N_{CS} (Number of Cyclic Shifts) PRACH preamble sequence generation. Value of N_{CS} will be determined by this value and Cyclic Shift Set.
Preamble Index	Sets a value to give cyclic shift for PRACH preamble sequence generation.
Sync Resource (TDD only)	For a specific combination of PRACH configuration index and UL/DL configuration, there will be one or multiple random access resources for UE to use, this parameter sets the index of corresponding random access resource used as synchronization reference for measurement algorithm. 3GPP TS 36.211 V8.5.0 5.7 listed the random access preamble mapping in Table 5.7.1–4.
Power	Sets the PRACH average power level relative to the 0 dB point set by the PRACH Power.
S-RS Channel Parameters (3GPP TS 36.211 5.5.3)	
Cyclic Shift	Sets n_{SRS}^{CS} value to get Cyclic Shift alpha.
BW Config	Sets S-RS Bandwidth Configuration (C_{SRS}).
BW	Sets S-RS Bandwidth (B_{SRS}).
Tx Comb	Sets Transmission Comb (k_{TC}) of S-RS.
Hopping BW	Sets S-RS Hopping Bandwidth.
Freq Domain Position	Sets S-RS Frequency Domain Position (n_{RRC}).
Subframe Config	Sets S-RS Subframe Configuration.
Power	Sets the S-RS average power level relative to the 0 dB point set by the S-RS Power.
MaxUpPTS	Enables you to give the value of $srsMaxUpPts$ to indicate whether or not $m_{SRS,0}$ reconfiguration is enabled for UpPTS
Config Index	Sets S-RS Configuration Index (I_{SRS}). (3GPP TS 36.213 V8.5.0 8.2 Table 8.2–1~2)

Detection

See [Detection@29131@i](#).

Key Path:	Meas Setup, Chan Profile Setup, Edit User Mapping
Help Map ID:	Use 29131

Auto Detect Power Levels (Uplink)

See [Auto Detect Power Levels@40770@i](#).

Add User

Adds a new User and the new entry becomes the selected User. The new User will have all parameters of its channels set to the default values.

Key Path:	Meas Setup, Chan Profile Setup, Edit User Mapping, Users
Mode:	LTE, LTETDD
Remote Command:	[:SENSE] :EVM:ULINK:PROFile:ADD:USER
Example:	EVM:ULIN:PROF:ADD:USER
Notes:	Changes to this parameter will not be applied until Update Changes command is sent. See “ RB Parameter Manager (Uplink) ” on page 1073 section for more details.
Dependencies:	The new User will be added at the end of the currently defined Users. Disabled once the number of Slots reaches to 50, the max number.
Initial S/W Revision:	Prior to A.02.00
Modified at S/W Revision:	A.03.00
Help Map ID:	29217

Delete User

Deletes the current selected User.

Key Path:	Meas Setup, Chan Profile Setup, Edit User Mapping, User
Mode:	LTE, LTETDD
Remote Command:	[:SENSE] :EVM:ULINK:PROFile:USER<n>:DELeTe
Example:	EVM:ULIN:PROF:USER1:DEL
Notes:	Once a User is deleted, subsequent Users will be renumbered to keep User numbering sequential
Notes:	Changes to this parameter will not be applied until Update Changes command is sent. See “ RB Parameter Manager (Uplink) ” on page 1073 section for more details.

LTE Modulation Analysis Measurement
Meas Setup (Measurement Setup)

Dependencies:	The range of sub op code (n) values is determined by the number of Users the user has configured. If the user attempts to remotely delete a sub op code that is out of range, this will result in an error message. Disabled when there is only one User.
Initial S/W Revision:	Prior to A.02.00
Modified at S/W Revision:	A.03.00
Help Map ID:	29360

Cell ID

Sets uplink user's physical-layer Cell ID when Detection is Man.

Key Path:	Meas Setup, Chan Profile Setup, Edit User Mapping
Mode:	LTE, LTETDD
Remote Command:	[:SENSe] :EVM:ULINk:PROFile:USER<n>:CID <integer> [:SENSe] :EVM:ULINk:PROFile:USER<n>:CID?
Example:	EVM:ULIN:PROF:USER1:CID 1 EVM:ULIN:PROF:USER1:CID?
Notes:	Changes to this parameter will not be applied until Update Changes command is sent. See " RB Parameter Manager (Uplink) " on page 1073 section for more details.
Dependencies:	The range of sub op code <n> values is determined by the number of Users the user has configured. If the user attempts to remotely set or query a sub op code that is out of range, this will result in an error message Enabled when Detection is Manual.
Preset:	0
State Saved:	Saved in instrument state.
Min:	0
Max:	503
Initial S/W Revision:	Prior to A.02.00
Modified at S/W Revision:	A.03.00
Help Map ID:	29221

Auto Detect Cell ID

Sets uplink user's physical-layer Cell ID when Detection is Auto.

Key Path:	Meas Setup, Chan Profile Setup, Edit User Mapping, Cell ID
Mode:	LTE, LTETDD

Remote Command:	[:SENSe] :EVM:ULINk:PROFile:AUTO:CID <integer> [:SENSe] :EVM:ULINk:PROFile:AUTO:CID?
Example:	EVM:ULIN:PROF:AUTO:CID 1 EVM:ULIN:PROF:AUTO:CID?
Notes:	Changes to this parameter will not be applied until Update Changes command is sent. See “RB Parameter Manager (Uplink)” on page 1073 section for more details.
Dependencies:	Enabled when Detection is Auto.
Preset:	0
State Saved:	Saved in instrument state.
Min:	0
Max:	503
Initial S/W Revision:	Prior to A.02.00
Modified at S/W Revision:	A.03.00
Help Map ID:	0

RNTI

Sets uplink user's radio network temporary identifier.

Key Path:	Meas Setup, Chan Profile Setup, Edit User Mapping
Mode:	LTE, LTETDD
Remote Command:	[:SENSe] :EVM:ULINk:PROFile:USER<n>:RNTI <integer> [:SENSe] :EVM:ULINk:PROFile:USER<n>:RNTI?
Example:	EVM:ULIN:PROF:USER1:RNTI 1 EVM:ULIN:PROF:USER1:RNTI?
Notes:	Changes to this parameter will not be applied until Update Changes command is sent. See “RB Parameter Manager (Uplink)” on page 1073 section for more details.
Dependencies:	The range of sub op code <n> values is determined by the number of Users the user has configured. If the user attempts to remotely set or query a sub op code that is out of range, this will result in an error message. Available when Direction is Uplink and Detection is Manual.
Preset:	0
State Saved:	Saved in instrument state.
Min:	0
Max:	65535

LTE Modulation Analysis Measurement
Meas Setup (Measurement Setup)

Initial S/W Revision:	A.06.00
Help Map ID:	29242

Auto Detect RNTI

Sets uplink user's radio network temporary identifier.

Key Path:	Meas Setup, Chan Profile Setup, Edit User Mapping
Mode:	LTE, LTETDD
Remote Command:	[:SENSE] :EVM:ULINK:PROFile:AUTO:RNTI <integer> [:SENSE] :EVM:ULINK:PROFile:AUTO:RNTI?
Example:	EVM:ULIN:PROF:AUTO:RNTI 1 EVM:ULIN:PROF:AUTO:RNTI?
Notes:	Changes to this parameter will not be applied until Update Changes command is sent. See “RB Parameter Manager (Uplink)” on page 1073 section for more details.
Dependencies:	Available when Direction is Uplink and Detection is Auto.
Preset:	0
State Saved:	Saved in instrument state.
Min:	0
Max:	65535
Initial S/W Revision:	A.06.00
Help Map ID:	0

System Frame Number

Sets uplink user's System Frame Number when Detection is Man.

Key Path:	Meas Setup, Chan Profile Setup, Edit User Mapping
Mode:	LTE, LTETDD
Remote Command:	[:SENSE] :EVM:ULINK:PROFile:USER<n>:SFNumber <integer> [:SENSE] :EVM:ULINK:PROFile:USER<n>:SFNumber?
Example:	EVM:ULIN:PROF:USER1:SFN 0 EVM:ULIN:PROF:USER1:SFN?
Notes:	Changes to this parameter will not be applied until Update Changes command is sent. See “RB Parameter Manager (Uplink)” on page 1073 section for more details.

Dependencies:	The range of sub op code <n> values is determined by the number of Users the user has configured. If the user attempts to remotely set or query a sub op code that is out of range, this will result in an error message. Enabled when Detection is Manual.
Preset:	0
State Saved:	Saved in instrument state.
Min:	0
Max:	1023
Initial S/W Revision:	A.03.00
Help Map ID:	29081

Auto Detect System Frame Number

Sets uplink user's System Frame Number when Detection is Auto.

Key Path:	Meas Setup, Chan Profile Setup, Edit User Mapping
Mode:	LTE, LTETDD
Remote Command:	[:SENSe] :EVM:ULINk:PROfile:AUTO:SFNumber <integer> [:SENSe] :EVM:ULINk:PROfile:AUTO:SFNumber?
Example:	EVM:ULIN:PROF:AUTO:SFN 0 EVM:ULIN:PROF:AUTO:SFN?
Notes:	Changes to this parameter will not be applied until Update Changes command is sent. See “ RB Parameter Manager (Uplink) ” on page 1073 section for more details.
Dependencies:	Enabled when Detection is Auto.
Preset:	0
State Saved:	Saved in instrument state.
Min:	0
Max:	1023
Initial S/W Revision:	A.03.00
Help Map ID:	0

Group Hopping

Determines if Group Hopping is enabled when Detection is Manual.

Key Path:	Meas Setup, Chan Profile Setup, Edit User Mapping, Group Hopping
Mode:	LTE, LTETDD

LTE Modulation Analysis Measurement
Meas Setup (Measurement Setup)

Remote Command:	[:SENSe] :EVM:ULINk:PROFfile:USER<n>:HOPPing:GROup OFF ON 0 1 [:SENSe] :EVM:ULINk:PROFfile:USER<n>:HOPPing:GROup?
Example:	EVM:ULIN:PROF:USER1:HOPP:GRO OFF EVM:ULIN:PROF:USER1:HOPP:GRO?
Notes:	Changes to this parameter will not be applied until Update Changes command is sent. See “RB Parameter Manager (Uplink)” on page 1073 section for more details.
Dependencies:	Enabled when Detection is Manual.
Couplings:	Enabling Group Hopping disables Sequence Hopping.
Preset:	OFF
State Saved:	Saved in instrument state.
Initial S/W Revision:	Prior to A.02.00
Modified at S/W Revision:	A.03.00
Help Map ID:	29222

Auto Detect Group Hopping

Determines if Group Hopping is enabled when Detection is Auto.

Key Path:	Meas Setup, Chan Profile Setup, Edit User Mapping, Group Hopping
Mode:	LTE, LTETDD
Remote Command:	[:SENSe] :EVM:ULINk:PROFfile:AUTO:HOPPing:GROup OFF ON 0 1 [:SENSe] :EVM:ULINk:PROFfile:AUTO:HOPPing:GROup?
Example:	EVM:ULIN:PROF:AUTO:HOPP:GRO OFF EVM:ULIN:PROF:USER1:HOPP:GRO?
Notes:	Changes to this parameter will not be applied until Update Changes command is sent. See “RB Parameter Manager (Uplink)” on page 1073 section for more details.
Dependencies:	Enabled when Detection is Auto
Couplings:	Enabling Group Hopping disables Sequence Hopping.
Preset:	OFF
State Saved:	Saved in instrument state.
Initial S/W Revision:	Prior to A.02.00
Modified at S/W Revision:	A.03.00
Help Map ID:	0

Seq Hopping

Determines if Seq Hopping is enabled when Detection is Manual.

Key Path:	Meas Setup, Chan Profile Setup, Edit User Mapping, Seq Hopping
Mode:	LTE, LTETDD
Remote Command:	[:SENSe] :EVM:ULINk:PROFile:USER<n>:HOPPing:SEQuence OFF ON 0 1 [:SENSe] :EVM:ULINk:PROFile:USER<n>:HOPPing:SEQuence?
Example:	EVM:ULIN:PROF:USER1:HOPP:SEQ OFF EVM:ULIN:PROF:USER1:HOPP:SEQ?
Notes:	Changes to this parameter will not be applied until Update Changes command is sent. See “RB Parameter Manager (Uplink)” on page 1073 section for more details.
Dependencies:	The range of sub op code <n> values is determined by the number of Users the user has configured. Enabled when Detection is Manual.
Couplings:	Enabling Sequence Hopping disables Group Hopping.
Preset:	OFF
State Saved:	Saved in instrument state.
Initial S/W Revision:	Prior to A.02.00
Modified at S/W Revision:	A.03.00
Help Map ID:	29223

Auto Detect Seq Hopping

Determines if Seq Hopping is enabled when Detection is Auto.

Key Path:	Meas Setup, Chan Profile Setup, Edit User Mapping, Seq Hopping
Mode:	LTE, LTETDD
Remote Command:	[:SENSe] :EVM:ULINk:PROFile:AUTO:HOPPing:SEQuence OFF ON 0 1 [:SENSe] :EVM:ULINk:PROFile:AUTO:HOPPing:SEQuence?
Example:	EVM:ULIN:PROF:AUTO:HOPP:SEQ OFF EVM:ULIN:PROF:AUTO:HOPP:SEQ?
Notes:	Changes to this parameter will not be applied until Update Changes command is sent. See “RB Parameter Manager (Uplink)” on page 1073 section for more details.
Dependencies:	Enabled when Detection is Auto.

LTE Modulation Analysis Measurement
Meas Setup (Measurement Setup)

Couplings:	Enabling Sequence Hopping disables Group Hopping.
Preset:	OFF
State Saved:	Saved in instrument state.
Initial S/W Revision:	Prior to A.02.00
Modified at S/W Revision:	A.03.00
Help Map ID:	0

Include PUSCH

Refer to sections [“Include PUSCH ” on page 924](#) and [“Include Auto Detect PUSCH ” on page 924](#).

Mode:	LTE, LTETDD
Initial S/W Revision:	Prior to A.02.00
Modified at S/W Revision:	A.03.00
Help Map ID:	0

Include PUCCH

Refer to sections [“Include PUCCH ” on page 926](#) and [“Include Auto Detect PUCCH ” on page 927](#).

Mode:	LTE, LTETDD
Initial S/W Revision:	Prior to A.02.00
Modified at S/W Revision:	A.03.00
Help Map ID:	Use 29214

Include PRACH

Refer to section [“Include PRACH” on page 929](#) and [“Include Auto Detect PRACH” on page 930](#).

Mode:	LTE, LTETDD
Initial S/W Revision:	A.03.00
Help Map ID:	Use 40799

Include S-RS

Refer to section [“Include S-RS” on page 930](#) and [“Include Auto Detect S-RS” on page 931](#).

Mode:	LTE, LTETDD
Initial S/W Revision:	A.03.00
Help Map ID:	Use 40801

PUSCH Parameters

Displays a menu that enables you to select PUSCH parameters for signals.

Key Path:	Meas Setup, Chan Profile Setup, Edit User Mapping, PUSCH Parameters
Mode:	LTE, LTETDD
Initial S/W Revision:	Prior to A.02.00
Modified at S/W Revision:	A.03.00
Help Map ID:	30770

PUSCH Active

Selects whether or not PUSCH exists in the input signal when Detection is Manual.

Key Path:	Meas Setup, Chan Profile Setup, Edit User Mapping
Mode:	LTE, LTETDD
Remote Command:	[:SENSE] :EVM:ULINK:PROFile:USER1 50:PUSCh:ACTive OFF ON 0 1 [:SENSE] :EVM:ULINK:PROFile:USER1 50:PUSCh:ACTive?
Example:	EVM:ULIN:PROF:USER1:PUSC:ACT OFF EVM:ULIN:PROF:USER1:PUSC:ACT?
Notes:	Changes to this parameter will not be applied until Update Changes command is sent. See “RB Parameter Manager (Uplink)” on page 1073 section for more details.
Dependencies:	Enabled when Detection is Manual. All softkeys for PUSCH parameters are grayed out when this parameter is set to OFF.
Preset:	OFF
State Saved:	Saved in instrument state.
Initial S/W Revision:	A.03.00
Help Map ID:	40803

Auto Detect PUSCH Active

Selects whether or not PUSCH exists in the input signal when Detection is Auto.

Key Path:	Meas Setup, Chan Profile Setup, Edit User Mapping
Mode:	LTE, LTETDD
Remote Command:	[:SENSE] :EVM:ULINK:PROFile:AUTO:PUSCh:ACTive OFF ON 0 1 [:SENSE] :EVM:ULINK:PROFile:AUTO:PUSCh:ACTive?

LTE Modulation Analysis Measurement
Meas Setup (Measurement Setup)

Example:	EVM:ULIN:PROF:AUTO:PUSC:ACT OFF EVM:ULIN:PROF:AUTO:PUSC:ACT?
Notes:	Changes to this parameter will not be applied until Update Changes command is sent. See “RB Parameter Manager (Uplink)” on page 1073 section for more details.
Dependencies:	Enabled when Detection is Auto.
Preset:	ON
State Saved:	Saved in instrument state.
Initial S/W Revision:	A.03.00
Help Map ID:	0

DMRS Params

Determines if all DMRS parameters are common to all Slots or if they are to be defined on a per Slot basis when Detection is Manual.

Enabling this parameter causes DMRS Group, DMRS Seq, and DMRS Cyclic Shift to be set automatically using $n_{DMRS}(1)$, $n_{DMRS}(2)$ and ΔSS .

Key Path:	Meas Setup, Chan Profile Setup, Edit User Mapping, PUSCH, DMRS Params
Mode:	LTE, LTETDD
Remote Command:	[:SENSE] :EVM:ULINK:PROF:USER<n>:PUSCh:DMRS:PARams OFF ON 0 1 [:SENSE] :EVM:ULINK:PROF:USER<n>:PUSCh:DMRS:PARams?
Example:	EVM:ULIN:PROF:USER1:PUSC:DMRS:PAR OFF EVM:ULIN:PROF:USER1:PUSC:DMRS:PAR?
Notes:	Changes to this parameter will not be applied until Update Changes command is sent. See “RB Parameter Manager (Uplink)” on page 1073 section for more details.
Dependencies:	The range of sub op code <n> values is determined by the number of Users the user has configured. If the user attempts to remotely set or query a sub op code that is out of range, this will result in an error message. When this parameter is on, $n_{DMRS}(1)$, $n_{DMRS}(2)$ and SS are enabled and DMRS Group (u), DMRS Seq (v) and DMRS Cyclic Shift are disabled. When this parameter is off, $n_{DMRS}(1)$, $n_{DMRS}(2)$ and SS are disabled and DMRS Group (u), DMRS Seq (v) and DMRS Cyclic Shift are enabled.
Preset:	ON
State Saved:	Saved in instrument state.

Initial S/W Revision:	Prior to A.02.00
Modified at S/W Revision:	A.03.00
Help Map ID:	30772

Auto Detect DMRS Params

Determines if all DMRS parameters to be used are common to all Slots or if they are to be defined on a per Slot basis when Detection is Auto.

Key Path:	Meas Setup, Chan Profile Setup, Edit User Mapping, PUSCH, DMRS Params
Mode:	LTE, LTETDD
Remote Command:	[:SENSE] :EVM:ULINK:PROFile:AUTO:PUSCh:DMRS:PARams OFF ON 0 1 [:SENSE] :EVM:ULINK:PROFile:AUTO:PUSCh:DMRS:PARams?
Example:	EVM:ULIN:PROF:AUTO:PUSC:DMRS:PAR OFF EVM:ULIN:PROF:AUTO:PUSC:DMRS:PAR?
Notes:	Changes to this parameter will not be applied until Update Changes command is sent. See “RB Parameter Manager (Uplink)” on page 1073 section for more details.
Dependencies:	When this parameter is on n DMRS (1), n DMRS (2) and SS are enabled and DMRS Group (u), DMRS Seq (v) and DMRS Cyclic Shift are disabled. When this parameter is off, n DMRS (1), n DMRS (2) and SS are disabled and DMRS Group (u), DMRS Seq (v) and DMRS Cyclic Shift are enabled.
Preset:	ON
State Saved:	Saved in instrument state.
Initial S/W Revision:	Prior to A.02.00
Modified at S/W Revision:	A.03.00
Help Map ID:	0

n DMRS (1)

Sets the value of $n_{DMRS}(1)$ used by the selected user mapping when Detection is Manual.

Key Path:	Meas Setup, Chan Profile Setup, Edit User Mapping, PUSCH, n DMRS (1)
Mode:	LTE, LTETDD
Remote Command:	[:SENSE] :EVM:ULINK:PROFile:USER<n>:PUSCh:DMRS:ONE <integer> [:SENSE] :EVM:ULINK:PROFile:USER<n>:PUSCh:DMRS:ONE?

LTE Modulation Analysis Measurement
Meas Setup (Measurement Setup)

Example:	EVM:ULIN:PROF:USER1:PUSC:DMRS:ONE 1 EVM:ULIN:PROF:USER1:PUSC:DMRS:ONE?
Notes:	Changes to this parameter will not be applied until Update Changes command is sent. See “RB Parameter Manager (Uplink)” on page 1073 section for more details.
Dependencies:	The range of sub op code <n> values is determined by the number of Users the user has configured. Max value for n = 50. If the user attempts to remotely set or query a sub op code that is out of range, this will result in an error message. Enabled when Detection is Manual, DMRS Params is On, and PUSCH Active is ON.
Preset:	0
State Saved:	Saved in instrument state.
Min:	0
Max:	10
Initial S/W Revision:	Prior to A.02.00
Modified at S/W Revision:	A.03.00
Help Map ID:	29224

Auto Detect n DMRS (1)

Sets the value of $n_{DMRS}(1)$ used by the selected user mapping when Detection is Auto.

Key Path:	Meas Setup, Chan Profile Setup, Edit User Mapping, PUSCH, n DMRS (1)
Mode:	LTE, LTETDD
Remote Command:	[:SENSe] :EVM:ULINk:PROFile:AUTO:PUSCh:DMRS:ONE <integer> [:SENSe] :EVM:ULINk:PROFile:AUTO:PUSCh:DMRS:ONE?
Example:	EVM:ULIN:PROF:AUTO:PUSC:DMRS:ONE 1 EVM:ULIN:PROF:AUTO:PUSC:DMRS:ONE?
Notes:	Changes to this parameter will not be applied until Update Changes command is sent. See “RB Parameter Manager (Uplink)” on page 1073 section for more details.
Dependencies:	If the user attempts to remotely set or query a sub op code that is out of range, this will result in an error message. Enabled when Detection is Auto, Auto Detect DMRS Params is On, and Auto Detect PUSCH Active is ON.
Preset:	0

State Saved:	Saved in instrument state.
Min:	0
Max:	10
Initial S/W Revision:	Prior to A.02.00
Modified at S/W Revision:	A.03.00
Help Map ID:	0

n DMRS (2)

Sets the value of $n_{DMRS}(2)$ used by the selected user mapping when Detection is Manual.

Key Path:	Meas Setup, Chan Profile Setup, Edit User Mapping, PUSCH, n DMRS (2)
Mode:	LTE, LTETDD
Remote Command:	[:SENSe] :EVM:ULINk:PROFile:USER<n>:PUSCh:DMRS:TWO <integer> [:SENSe] :EVM:ULINk:PROFile:USER<n>:PUSCh:DMRS:TWO?
Example:	EVM:ULIN:PROF:USER1:PUSC:DMRS:TWO 1 EVM:ULIN:PROF:USER1:PUSC:DMRS:TWO?
Notes:	Changes to this parameter will not be applied until Update Changes command is sent. See “RB Parameter Manager (Uplink)” on page 1073 section for more details.
Dependencies:	The range of sub op code <n> values is determined by the number of Users the user has configured. Max value for n = 50. If the user attempts to remotely set or query a sub op code that is out of range, this will result in an error message. Enabled when Detection is Manual, DMRS Params is On, and PUSCH Active is ON.
Preset:	0
State Saved:	Saved in instrument state.
Min:	0
Max:	10
Initial S/W Revision:	Prior to A.02.00
Modified at S/W Revision:	A.03.00
Help Map ID:	30773

LTE Modulation Analysis Measurement
Meas Setup (Measurement Setup)

Auto Detect n DMRS (2)

Sets the value of $n_{DMRS(2)}$ used by the selected user mapping when Detection is Auto.

Key Path:	Meas Setup, Chan Profile Setup, Edit User Mapping, PUSCH, n DMRS (2)
Mode:	LTE, LTETDD
Remote Command:	[:SENSe] :EVM:ULINk:PROFile:AUTO:PUSCh:DMRS:TWO <integer> [:SENSe] :EVM:ULINk:PROFile:AUTO:PUSCh:DMRS:TWO?
Example:	EVM:ULIN:PROF:AUTO:PUSC:DMRS:TWO 1 EVM:ULIN:PROF:AUTO:PUSC:DMRS:TWO?
Notes:	Changes to this parameter will not be applied until Update Changes command is sent. See “RB Parameter Manager (Uplink)” on page 1073 section for more details.
Dependencies:	If the user attempts to remotely set or query a sub op code that is out of range, this will result in an error message. Enabled when Detection is Auto and Auto Detect DMRS Params is On, and Auto Detect PUSCH Active is ON.
Preset:	0
State Saved:	Saved in instrument state.
Min:	0
Max:	10
Initial S/W Revision:	Prior to A.02.00
Modified at S/W Revision:	A.03.00
Help Map ID:	0

DSS (Delta SS)

Sets the value of Delta SS used by the selected user mapping when Detection is Manual.

Key Path:	Meas Setup, Chan Profile Setup, Edit User Mapping, PUSCH, ΔSS
Mode:	LTE, LTETDD
Remote Command:	[:SENSe] :EVM:ULINk:PROFile:USER<n>:PUSCh:DSS <integer> [:SENSe] :EVM:ULINk:PROFile:USER<n>:PUSCh:DSS?
Example:	EVM:ULIN:PROF:USER1:PUSC:DSS 1 EVM:ULIN:PROF:USER1:PUSC:DSS?
Notes:	Changes to this parameter will not be applied until Update Changes command is sent. See “RB Parameter Manager (Uplink)” on page 1073 section for more details.

Dependencies:	The range of sub op code <n> values is determined by the number of Users the user has configured. Max value for n = 50. If the user attempts to remotely set or query a sub op code that is out of range, this will result in an error message. Enabled when Detection is Manual, DMRS Params is On, and PUSCH Active is ON.
Preset:	0
State Saved:	Saved in instrument state.
Min:	0
Max:	29
Initial S/W Revision:	Prior to A.02.00
Modified at S/W Revision:	A.03.00
Help Map ID:	30774

Auto Detect Δ SS (Delta SS)

Sets the value of Delta SS used by the selected user mapping when Detection is Auto.

Key Path:	Meas Setup, Chan Profile Setup, Edit User Mapping, PUSCH, ΔSS
Mode:	LTE, LTETDD
Remote Command:	[:SENSE] :EVM:ULINK:PROfile:AUTO:PUSCh:DSS <integer> [:SENSE] :EVM:ULINK:PROfile:AUTO:PUSCh:DSS?
Example:	EVM:ULIN:PROF:AUTO:PUSC:DSS 1 EVM:ULIN:PROF:AUTO:PUSC:DSS?
Notes:	Changes to this parameter will not be applied until Update Changes command is sent. See “RB Parameter Manager (Uplink)” on page 1073 section for more details.
Dependencies:	If the user attempts to remotely set or query a sub op code that is out of range, this will result in an error message. Enabled when Detection is Auto, Auto Detect DMRS Params is On, and Auto Detect PUSCH Active is ON.
Preset:	0
State Saved:	Saved in instrument state.
Min:	0
Max:	29
Initial S/W Revision:	Prior to A.02.00
Modified at S/W Revision:	A.03.00

Help Map ID:	0
--------------	---

Frequency Hopping

Selects the frequency hopping type or disables frequency hopping. (3GPP TS 36.211 5.3.4)

The following table shows the combination and its corresponding Freq Hopping selection.

Note that “Type 1, +1/4” and “Type 1, -1/4” are available only when Bandwidth is set to more than or equal to 10MHz.

		Frequency Hopping				
		Off	Type1, +1/4	Type 1, -1/4	Type 1, +1/2	Type 2
Frequency Hopping Mode	Intra- SF	OF F	T1ISF00	T1ISF01	T1ISF10	T2ISF
	Intra/Inter-S F	OF F	T1IISF00	T1IISF01	T1IISF10	T2IISF

Frequency Hopping SCPI Command

Key Path:	SCPI Only
Mode:	LTE, LTETDD
Remote Command:	[:SENSe] :EVM:ULINk:PROFile:USER<n>:PUSCh: FHOPping OFF T1ISF00 T1IISF00 T1ISF01 T1IISF01 T1ISF10 T1IISF10 T2ISF T2IISF [:SENSe] :EVM:ULINk:PROFile:USER<n>:PUSCh:FHOPping?
Example:	EVM:ULIN:PROF:USER1:PUSC:FHOP OFF EVM:ULIN:PROF:USER1:PUSC:FHOP?
Notes:	Changes to this parameter will not be applied until Update Changes command is sent. See “RB Parameter Manager (Uplink)” on page 1073 for more details.
Dependencies:	The range of sub op code <n> values is determined by the number of Users the user has configured. If the user attempts to remotely set or query a sub op code that is out of range, this will result in an error message. Available when Detection is Manual.
Preset:	OFF
State Saved:	Saved in instrument state.
Initial S/W Revision:	A.03.00
Modified at S/W Revision:	A.06.00
Help Map ID:	40807

Auto Detect Frequency Hopping SCPI Command

Selects the frequency hopping type or disables frequency hopping when Detection is Auto. (3GPP TS 36.211 5.3.4)

Key Path:	SCPI only
Mode:	LTE, LTETDD
Remote Command:	[:SENSe] :EVM:ULINk:PROFile:AUTO:PUSCh:FHOPping OFF T1ISF00 T1IISF00 T1ISF01 T1IISF01 T1ISF10 T1IISF10 T2ISF T2IISF [:SENSe] :EVM:ULINk:PROFile:AUTO:PUSCh:FHOPping?
Example:	EVM:ULIN:PROF:AUTO:PUSC:FHOP T2IISF EVM:ULIN:PROF:AUTO:PUSC:FHOP?
Notes:	Changes to this parameter will not be applied until Update Changes command is sent. See “RB Parameter Manager (Uplink)” on page 1073 section for more details.

LTE Modulation Analysis Measurement
Meas Setup (Measurement Setup)

Dependencies:	Available when Detection is Auto and Auto Detect PUSCH Active is ON.
Preset:	OFF
State Saved:	Saved in instrument state.
Range:	Off Type1 InterSF00 Type1 IntraInterSF00 Type1InterSF01 Type1IntraInterSF01 Type1 InterSF10 Type1IntraInterSF10 Type2InterSF Type2 IntraInterSF
Initial S/W Revision:	A.03.00
Modified at S/W Revision:	A.06.00
Help Map ID:	0

Frequency Hopping

Selects frequency hopping or disables frequency hopping. (3GPP TS 36.211 V8.5.0 5.3.4)

Key Path:	Meas Setup, Chan Profile Setup, Edit User Mapping
Mode:	LTE, LTETDD
Notes:	Changes to this parameter will not be applied until Update Changes command is sent. See “RB Parameter Manager (Uplink)” on page 1073 section for more details.
Dependencies:	Available when PUSCH Active is ON. “Type 1, +1/4” and “Type 1, -1/4” are enabled only when Bandwidth is set to more than or equal to 10MHz.
Preset:	OFF
State Saved:	Saved in instrument state.
Range:	OFF Type 1, +1/4 Type 1, -1/4 Type 1, +1/2 Type 2
Initial S/W Revision:	A.03.00
Modified at S/W Revision:	A.06.00
Help Map ID:	0

Frequency Hopping Mode

Selects the frequency hopping mode. (3GPP TS 36.211 V8.5.0 5.3.4)

Key Path:	Meas Setup, Chan Profile Setup, Edit User Mapping
Mode:	LTE, LTETDD
Notes:	Changes to this parameter will not be applied until the Update Changes command is sent. See “RB Parameter Manager (Uplink)” on page 1073 section for more details.
Dependencies:	Available when PUSCH Active is ON.

Preset:	OFF
State Saved:	Saved in instrument state.
Range:	Inter-SF Intra/Inter-SF
Initial S/W Revision:	A.03.00
Modified at S/W Revision:	A.06.00
Help Map ID:	0

Hopping Offset (NRBHO)

Sets the value of Hopping Offset (N_{RB}^{HO}) when Detection is Manual. Hopping Offset is the offset used for PUSCH frequency hopping, expressed in number of resource blocks. (3GPP TS 36.211 V8.5.0 5.3.4).

Key Path:	Meas Setup, Chan Profile Setup, Edit User Mapping, PUSCH
Mode:	LTE, LTETDD
Remote Command:	[:SENSE] :EVM:ULINK:PROFile:USER<n>:PUSCh:NRBHo:<integer> > [:SENSE] :EVM:ULINK:PROFile:USER<n>:PUSCh:NRBHo?
Example:	EVM:ULIN:PROF:USER1:PUSC:NRBH 1 EVM:ULIN:PROF:USER1:PUSC:NRBH?
Notes:	Changes to this parameter will not be applied until Update Changes command is sent. See “RB Parameter Manager (Uplink)” on page 1073 section for more details.
Dependencies:	The range of sub op code <n> values is determined by the number of Users the user has configured. If the user attempts to remotely set or query a sub op code that is out of range, this will result in an error message. Enabled when Detection is Manual, Frequency Hopping is not OFF, and PUSCH Active is ON.
Couplings:	Hopping Offset should always be less than or equal to the total RB number of the selected Bandwidth.
Preset:	0
State Saved:	Saved in instrument state.
Min:	0

LTE Modulation Analysis Measurement
Meas Setup (Measurement Setup)

Max:	6 - Bandwidth 1.4 MHz 15 - Bandwidth 3 MHz 25 - Bandwidth 5 MHz 50 - Bandwidth 10 MHz 75 - Bandwidth 15 MHz 100 - Bandwidth 20 MHz
Initial S/W Revision:	A.03.00
Modified at S/W Revision:	A.06.00
Help Map ID:	40814

Auto Detect Hopping Offset (NRBHO)

Sets the value of Hopping Offset (N_{RB}^{HO}) when Detection is Auto. Hopping Offset is the offset used for PUSCH frequency hopping, expressed in number of resource blocks. (3GPP TS 36.211 V8.5.0 5.3.4).

Key Path:	Meas Setup, Chan Profile Setup, Edit User Mapping, PUSCH
Mode:	LTE, LTETDD
Remote Command:	[:SENSE] :EVM:ULINk:PROFile:AUTO:PUSCh:NRBHo <integer> [:SENSE] :EVM:ULINk:PROFile:AUTO:PUSCh:NRBHo?
Example:	EVM:ULIN:PROF:AUTO:PUSC:NRBH 1 EVM:ULIN:PROF:AUTO:PUSC:NRBH?
Notes:	Changes to this parameter will not be applied until Update Changes command is sent. See “RB Parameter Manager (Uplink)” on page 1073 section for more details.
Dependencies:	Enabled when Detection is Auto, Auto Detect Frequency Hopping is not OFF, and Auto Detect PUSCH Active is ON.
Couplings:	Hopping Offset should always be less than or equal to the total RB number of the selected Bandwidth.
Preset:	0
State Saved:	Saved in instrument state.
Min:	0
Max:	6 - Bandwidth 1.4 MHz 15 - Bandwidth 3 MHz 25 - Bandwidth 5 MHz 50 - Bandwidth 10 MHz 75 - Bandwidth 15 MHz 100 - Bandwidth 20 MHz

Initial S/W Revision:	A.03.00
Modified at S/W Revision:	A.06.00
Help Map ID:	0

Number of sub-bands (Nsb)

Sets the number of sub-bands (N_{sb}) when Detection is Manual. (3GPP TS 36.211 V8.5.0 5.3.4).

Key Path:	Meas Setup, Chan Profile Setup, Edit User Mapping, PUSCH
Mode:	LTE, LTETDD
Remote Command:	[:SENSe] :EVM:ULINk:PROFile:USER<n>:PUSCh:NSB <integer> [:SENSe] :EVM:ULINk:PROFile:USER<n>:PUSCh:NSB?
Example:	EVM:ULIN:PROF:USER1:PUSC:NSB 1 EVM:ULIN:PROF:USER1:PUSC:NSB?
Notes:	Changes to this parameter will not be applied until Update Changes command is sent. See “RB Parameter Manager (Uplink)” on page 1073 section for more details.
Dependencies:	The range of sub op code <n> values is determined by the number of Users the user has configured. If the user attempts to remotely set or query a sub op code that is out of range, this will result in an error message. Enabled when Detection is Manual, Frequency Hopping is set to either Type2InterSF or Type2InterIntraSF, and PUSCH Active is ON.
Couplings:	Nsb should always be less than or equal to the total RB number of the selected Bandwidth.
Preset:	1
State Saved:	Saved in instrument state.
Min:	1
Max:	4
Initial S/W Revision:	A.03.00
Modified at S/W Revision:	A.06.00, A.10.00
Help Map ID:	40815

Auto Detect Number of Sub-bands (Nsb)

Sets the Number of Sub-bands (N_{sb}) when Detection is Auto. (3GPP TS 36.211 V8.5.0 5.3.4).

Key Path:	Meas Setup, Chan Profile Setup, Edit User Mapping, PUSCH
Mode:	LTE, LTETDD
Remote Command:	[:SENSe] :EVM:ULINk:PROFile:AUTO:PUSCh:NSB <integer> [:SENSe] :EVM:ULINk:PROFile:AUTO:PUSCh:NSB?
Example:	EVM:ULIN:PROF:AUTO:PUSC:NSB 1 EVM:ULIN:PROF:AUTO:PUSC:NSB?
Notes:	Changes to this parameter will not be applied until Update Changes command is sent. See “ RB Parameter Manager (Uplink) ” on page 1073 section for more details.
Dependencies:	Enabled when Detection is Auto, Auto Detect Frequency Hopping is set to either Type2InterSF or Type2InterIntraSF, and Auto Detect PUSCH Active is ON.
Couplings:	Nsb should always be less than or equal to the total RB number of the selected Bandwidth.
Preset:	1
State Saved:	Saved in instrument state.
Min:	1
Max:	4
Initial S/W Revision:	A.03.00
Modified at S/W Revision:	A.06.00, A.10.00
Help Map ID:	0

PUSCH Sync Slot

Sets the Sync Slot for all PUSCH Slots when Detection is Manual.

Sync Slot specifies the index of the slot to use for initial synchronization when PUSCH is selected as the Sync Type. The demodulator searches for the slot with the characteristics specified in Per-slot Parameters and the slot that matches the Per-slot Parameters with the highest correlation will be assigned the slot number given in the Sync Slot parameter.

When Sync Slot is set to Auto, the demod algorithm may automatically determine the best time slot to synchronize to. This approach simplifies parameter entry and provides easier setup. However, the complexity of the algorithm makes it rather slow and prone to errors in the presence of noise.

Key Path:	Meas Setup, Chan Profile Setup, Edit User Mapping
Mode:	LTE, LTETDD

Remote Command:	<pre>[:SENSe] :EVM:ULINk:PROFile:USER<n>:PUSCh:SSLot:<integer> [:SENSe] :EVM:ULINk:PROFile:USER<n>:PUSCh:SSLot? [:SENSe] :EVM:ULINk:PROFile:USER<n>:PUSCh:SSLot:AUTO OFF ON 0 1 [:SENSe] :EVM:ULINk:PROFile:USER<n>:PUSCh:SSLot:AUTO?</pre>
Example:	<pre>EVM:ULIN:PROF:USER1:PUSC:SSL 1 EVM:ULIN:PROF:USER1:PUSC:SSL? EVM:ULIN:PROF:USER1:PUSC:SSL:AUTO 1 EVM:ULIN:PROF:USER1:PUSC:SSL:AUTO?</pre>
Notes:	Changes to this parameter will not be applied until Update Changes command is sent. See “RB Parameter Manager (Uplink)” on page 1073 section for more details.
Dependencies:	<p>The range of sub op code <n> values is determined by the number of Users the user has configured. Max value for n=50.</p> <p>If the user attempts to remotely set or query a sub op code that is out of range, this will result in an error message.</p> <p>PUSCH Sync Slot is enabled when PUSCH Active is ON, Detection is Manual and PUSCH Sync Slot Auto is OFF.</p> <p>PUSCH Sync Slot Auto is enabled when PUSCH Active is ON and Detection is Manual</p>
Preset:	0 ON
State Saved:	Saved in instrument state.
Min:	0
Max:	19
Initial S/W Revision:	Prior to A.02.00
Modified at S/W Revision:	A.03.00
Help Map ID:	30771

Auto Detect PUSCH Sync Slot

Sets the Sync Slot for all PUSCH Slots when Detection is Auto.

Key Path:	Meas Setup, Chan Profile Setup, Edit User Mapping
Mode:	LTE, LTETDD

LTE Modulation Analysis Measurement
Meas Setup (Measurement Setup)

Remote Command:	[:SENSe]:EVM:ULINk:PROFile:AUTO:PUSCh:SSLot <integer> [:SENSe]:EVM:ULINk:PROFile:AUTO:PUSCh:SSLot? [:SENSe]:EVM:ULINk:PROFile:AUTO:PUSCh:SSLot:AUTO OFF ON 0 1 [:SENSe]:EVM:ULINk:PROFile:AUTO:PUSCh:SSLot:AUTO?
Example:	EVM:ULIN:PROF:AUTO:PUSC:SSL 1 EVM:ULIN:PROF:AUTO:PUSC:SSL? EVM:ULIN:PROF:AUTO:PUSC:SSL:AUTO 1 EVM:ULIN:PROF:AUTO:PUSC:SSL:AUTO?
Notes:	Changes to this parameter will not be applied until Update Changes command is sent. See “ RB Parameter Manager (Uplink) ” on page 1073 section for more details.
Dependencies:	Auto Detect PUSCH Sync Slot is enabled when Auto Detect PUSCH Active is ON, Detection is Auto and Auto Detect PUSCH Sync Slot Auto is OFF. Auto Detect PUSCH Sync Slot Auto is enabled when Auto Detect PUSCH Active is ON and Detection is Auto.
Preset:	0 ON
State Saved:	Saved in instrument state.
Min:	0
Max:	19
Initial S/W Revision:	Prior to A.02.00
Modified at S/W Revision:	A.03.00
Help Map ID:	0

PUSCH Couple

Selecting the checkbox next to a parameter in the PUSCH Per-slot Parameters area will couple that parameter across all RB allocation.

Key Path:	Meas Setup, Chan Profile Setup, Edit User Mapping
Help Map ID:	40875

Common RB Start

Specifies the RB start boundary when Couple is On.

Key Path:	Meas Setup, Chan Profile Setup, Edit User Mapping, PUSCH
Help Map ID:	40876

RB Start

Sets the Start Resource Block for all the PUSCH Slots when RB Start Couple is On and when Detection is Manual.

Key Path:	Meas Setup, Chan Profile Setup, Edit User Mapping, PUSCH, RB Start
Mode:	LTE, LTETDD
Remote Command:	[:SENSe] :EVM:ULINk:PROFile:USER<n>:PUSCh:RB:STARt <integer> [:SENSe] :EVM:ULINk:PROFile:USER<n>:PUSCh:RB:STARt?
Example:	EVM:ULIN:PROF:USER1:PUSC:RB:STAR 0 EVM:ULIN:PROF:USER1:PUSC:RB:STAR?
Notes:	Changes to this parameter will not be applied until Update Changes command is sent. See “RB Parameter Manager (Uplink)” on page 1073 section for more details.
Dependencies:	The range of sub op code <n> values is determined by the number of Users the user has configured. Max value for n = 50. If the user attempts to remotely set or query a sub op code that is out of range, this will result in an error message. Enabled when Detection is Manual, RB Start Couple is ON, and PUSCH Active is ON.
Couplings:	If the user attempts to set a RB Start value greater than the RB Stop value, both values will be set to the RB Start value or clipped to the min or max value if the entered value is out of range
Preset:	0
State Saved:	Saved in instrument state.
Min:	0
Max:	5 – Bandwidth 1.4 MHz 14 – Bandwidth 3 MHz 24 – Bandwidth 5 MHz 49 – Bandwidth 10 MHz 74 – Bandwidth 15 MHz 99 – Bandwidth 20 MHz
Initial S/W Revision:	Prior to A.02.00
Modified at S/W Revision:	A.03.00
Help Map ID:	29225

LTE Modulation Analysis Measurement
Meas Setup (Measurement Setup)

Auto Detect RB Start

Sets the Start Resource Block for all the PUSCH Slots when Detection is Auto.

Key Path:	Meas Setup, Chan Profile Setup, Edit User Mapping, PUSCH, RB Start
Mode:	LTE, LTETDD
Remote Command:	[:SENSE] :EVM:ULINK:PROF:Auto:PUSCh:RB:START <integer> [:SENSE] :EVM:ULINK:PROF:Auto:PUSCh:RB:START?
Example:	EVM:ULIN:PROF:Auto:PUSC:RB:STAR 0 EVM:ULIN:PROF:Auto:PUSC:RB:STAR?
Notes:	Changes to this parameter will not be applied until Update Changes command is sent. See “RB Parameter Manager (Uplink)” on page 1073 section for more details.
Dependencies:	Enabled when Detection is Auto and Auto Detect PUSCH Auto Sync Slot is OFF, and Auto Detect PUSCH Active is ON.
Couplings:	If the user attempts to set a RB Start value greater than the RB Stop value, both values will be set to the RB Start value or clipped to the min or max value if the entered value is out of range
Preset:	0
State Saved:	Saved in instrument state.
Min:	0
Max:	5 – Bandwidth 1.4 MHz 14 – Bandwidth 3 MHz 24 – Bandwidth 5 MHz 49 – Bandwidth 10 MHz 74 – Bandwidth 15 MHz 99 – Bandwidth 20 MHz
Initial S/W Revision:	Prior to A.02.00
Modified at S/W Revision:	A.03.00
Help Map ID:	0

RB Start Couple

Determines whether or not all the PUSCH Slots will use the Common RB Start value.

Key Path:	Meas Setup, Chan Profile Setup, Edit User Mapping, PUSCH, Couple Power Boost
Mode:	LTE, LTETDD

Remote Command:	[:SENSE] :EVM:ULINk:PROFile:USER<n>:PUSCh:RB:STARt:COUPl e OFF ON 0 1 [:SENSe] :EVM:ULINk:PROFile:USER<n>:PUSCh:RB:STARt:COUPl e?
Example:	EVM:ULIN:PROF:USER1:PUSC:RB:STAR:COUP ON EVM:ULIN:PROF:USER1:PUSC:RB:STAR:COUP?
Notes:	Changes to this parameter will not be applied until Update Changes command is sent. See “RB Parameter Manager (Uplink)” on page 1073 section for more details.
Dependencies:	The range of sub op code <n> values is determined by the number of Users the user has configured. Max value for n = 50. If the user attempts to remotely set or query a sub op code that is out of range, this will result in an error message. Enabled when Detection is Manual, and PUSCH Active is ON.
Preset:	ON
State Saved:	Saved in instrument state.
Initial S/W Revision:	Prior to A.02.00
Modified at S/W Revision:	A.03.00
Help Map ID:	29226

Common RB End

Specifies the RB end boundary.

Key Path:	Meas Setup, Chan Profile Setup, Edit User Mapping, PUSCH
Help Map ID:	40877

RB End

Sets the End Resource Block for all the PUSCH Slots when RB End Couple is On and when Detection is Manual.

Key Path:	Meas Setup, Chan Profile Setup, Edit User Mapping, PUSCH, RB End
Mode:	LTE, LTETDD
Remote Command:	[:SENSE] :EVM:ULINk:PROFile:USER<n>:PUSCh:RB:END <integer> [:SENSe] :EVM:ULINk:PROFile:USER<n>:PUSCh:RB:END?
Example:	EVM:ULIN:PROF:USER1:PUSC:RB:END 0 EVM:ULIN:PROF:USER1:PUSC:RB:END?

LTE Modulation Analysis Measurement
Meas Setup (Measurement Setup)

Notes:	Changes to this parameter will not be applied until Update Changes command is sent. See “ RB Parameter Manager (Uplink) ” on page 1073 section for more details.
Dependencies:	The range of sub op code <n> values is determined by the number of Users the user has configured. Max value for n = 50. If the user attempts to remotely set or query a sub op code that is out of range, this will result in an error message. Enabled when Detection is Manual, RB End Couple is ON, and PUSCH Active is ON.
Couplings:	If the user attempts to set a RB End value less than the RB Start value, both values will be set to the RB End value or clipped to the min or max value if the entered value is out of range
Preset:	0
State Saved:	Saved in instrument state.
Min:	0
Max:	5 – Bandwidth 1.4 MHz 14 – Bandwidth 3 MHz 24 – Bandwidth 5 MHz 49 – Bandwidth 10 MHz 74 – Bandwidth 15 MHz 99 – Bandwidth 20 MHz
Initial S/W Revision:	Prior to A.02.00
Modified at S/W Revision:	A.03.00
Help Map ID:	29227

Auto Detect RB End

Sets the End Resource Block for all the PUSCH Slots when Detection is Auto.

Key Path:	Meas Setup, Chan Profile Setup, Edit User Mapping, PUSCH, RB End
Mode:	LTE, LTETDD
Remote Command:	[:SENSE] :EVM:ULINK:PROFfile:AUTO:PUSCh:RB:END <integer> [:SENSe] :EVM:ULINK:PROFfile:AUTO:PUSCh:RB:END?
Example:	EVM:ULIN:PROF:AUTO:PUSC:RB:END 0 EVM:ULIN:PROF:AUTO:PUSC:RB:END?
Notes:	Changes to this parameter will not be applied until Update Changes command is sent. See “ RB Parameter Manager (Uplink) ” on page 1073 section for more details.

Dependencies:	Enabled when Detection is Auto, Auto Detect PUSCH Auto Sync Slot is OFF, and Auto Detect PUSCH Active is ON.
Couplings:	If the user attempts to set a RB End value less than the RB Start value, both values will be set to the RB End value or clipped to the min or max value if the entered value is out of range
Preset:	0
State Saved:	Saved in instrument state.
Min:	0
Max:	5 – Bandwidth 1.4 MHz 14 – Bandwidth 3 MHz 24 – Bandwidth 5 MHz 49 – Bandwidth 10 MHz 74 – Bandwidth 15 MHz 99 – Bandwidth 20 MHz
Initial S/W Revision:	Prior to A.02.00
Modified at S/W Revision:	A.03.00
Help Map ID:	0

RB End Couple

Determines whether or not all the PUSCH Slots will use the Common RB Start value.

Key Path:	Meas Setup, Chan Profile Setup, Edit User Mapping, PUSCH, Couple Power Boost
Mode:	LTE, LTETDD
Remote Command:	[:SENSE] :EVM:ULINK:PROfile:USER<n>:PUSCh:RB:END:COUple OFF ON 0 1 [:SENSe] :EVM:ULINK:PROfile:USER<n>:PUSCh:RB:END:COUple?
Example:	EVM:ULIN:PROF:USER1:PUSC:RB:END:COUP ON EVM:ULIN:PROF:USER1:PUSC:RB:END:COUP?
Notes:	Changes to this parameter will not be applied until Update Changes command is sent. See “RB Parameter Manager (Uplink)” on page 1073 section for more details.
Dependencies:	The range of sub op code <n> values is determined by the number of Users the user has configured. Max value for n = 50. If the user attempts to remotely set or query a sub op code that is out of range, this will result in an error message. Enabled when Detection is Manual, and PUSCH Active is ON.

LTE Modulation Analysis Measurement
Meas Setup (Measurement Setup)

Preset:	ON
State Saved:	Saved in instrument state.
Initial S/W Revision:	Prior to A.02.00
Modified at S/W Revision:	A.03.00
Help Map ID:	29228

Common Mod Type

Selects the Modulation Type for all the PUSCH Slots when Mod Type Couple is On and Detection is Manual.

Key Path:	Meas Setup, Chan Profile Setup, Edit User Mapping, PUSCH, Mod Type
Mode:	LTE, LTETDD
Remote Command:	[:SENSe] :EVM:ULINk:PROFile:USER<n>:PUSCh:MODulation:TYPE QPSK QAM16 QAM64 [:SENSe] :EVM:ULINk:PROFile:USER<n>:PUSCh:MODulation:TYPE?
Example:	EVM:ULIN:PROF:USER1:PUSC:MOD:TYPE QPSK EVM:ULIN:PROF:USER1:PUSC:MOD:TYPE?
Notes:	Changes to this parameter will not be applied until Update Changes command is sent. See “RB Parameter Manager (Uplink)” on page 1073 section for more details.
Dependencies:	The range of sub op code <n> values is determined by the number of Users the user has configured. Max value for n=50. If the user attempts to remotely set or query a sub op code that is out of range, this will result in an error message. Enabled when Mod Type Couple is On, Detection is Manual, and PUSCH Active is ON.
Preset:	QPSK
State Saved:	Saved in instrument state.
Range:	QPSK 16QAM 64QAM
Initial S/W Revision:	Prior to A.02.00
Modified at S/W Revision:	A.03.00
Help Map ID:	29291

Auto Detect Mod Type

Selects the Modulation Type for all the PUSCH Slots when Detection is Auto.

Key Path:	Meas Setup, Chan Profile Setup, Edit User Mapping, PUSCH, Mod Type
-----------	---

Mode:	LTE, LTETDD
Remote Command:	[:SENSe] :EVM:ULINk:PROFile:AUTO:PUSCh:MODulation:TYPE QPSK QAM16 QAM64 [:SENSe] :EVM:ULINk:PROFile:AUTO:PUSCh:MODulation:TYPE?
Example:	EVM:ULIN:PROF:AUTO:PUSC:MOD:TYPE QPSK EVM:ULIN:PROF:AUTO:PUSC:MOD:TYPE?
Notes:	Changes to this parameter will not be applied until Update Changes command is sent. See “RB Parameter Manager (Uplink)” on page 1073 section for more details.
Dependencies:	Always grayed out.
Preset:	QPSK
State Saved:	Saved in instrument state.
Range:	QPSK 16QAM 64QAM
Initial S/W Revision:	Prior to A.02.00
Modified at S/W Revision:	A.03.00
Help Map ID:	0

QPSK

Selects QPSK for the Modulation Type for all the PUSCH Slots when Mod Type Couple is On.

Key Path:	Meas Setup, Chan Profile Setup, Edit User Mapping, PUSCH, Mod Type
Mode:	LTE, LTETDD
Initial S/W Revision:	Prior to A.02.00
Modified at S/W Revision:	A.03.00
Help Map ID:	29292

16QAM

Selects 16QAM for the Modulation Type for all the PUSCH Slots when Mod Type Couple is On.

Key Path:	Meas Setup, Chan Profile Setup, Edit User Mapping, PUSCH, Couple Mod Type
Mode:	LTE, LTETDD
Initial S/W Revision:	Prior to A.02.00
Modified at S/W Revision:	A.03.00
Help Map ID:	30829

LTE Modulation Analysis Measurement
Meas Setup (Measurement Setup)

64QAM

Selects 64QAM for the Modulation Type for all the PUSCH Slots when Mod Type Couple is On.

Key Path:	Meas Setup, Chan Profile Setup, Edit User Mapping, PUSCH, Couple Mod Type
Mode:	LTE, LTETDD
Initial S/W Revision:	Prior to A.02.00
Modified at S/W Revision:	A.03.00
Help Map ID:	29294

Mod Type Couple

Determines whether or not all the PUSCH Slots will use the Common Mod Type value.

Key Path:	Meas Setup, Chan Profile Setup, Edit User Mapping, PUSCH, Couple Mod Type
Mode:	LTE, LTETDD
Remote Command:	[:SENSE] :EVM:ULINK:PROFile:USER<n>:PUSCh:MODulation:TYPE:COUPlE OFF ON 0 1 [:SENSE] :EVM:ULINK:PROFile:USER<n>:PUSCh:MODulation:TYPE:COUPlE?
Example:	EVM:ULIN:PROF:USER1:PUSC:MOD:TYPE:COUP ON EVM:ULIN:PROF:USER1:PUSC:MOD:TYPE:COUP?
Notes:	Changes to this parameter will not be applied until Update Changes command is sent. See “RB Parameter Manager (Uplink)” on page 1073 section for more details.
Dependencies:	The range of sub op code <n> values is determined by the number of Users the user has configured. Max value for n = 50. If the user attempts to remotely set or query a sub op code that is out of range, this will result in an error message. Enabled when Detection is Manual and PUSCH Active is ON.
Preset:	ON
State Saved:	Saved in instrument state.
Initial S/W Revision:	Prior to A.02.00
Modified at S/W Revision:	A.03.00
Help Map ID:	29295

Common Power Boost

Sets the PUSCH average power level relative to the 0 dB set by the PUSCH DMRS Power.

Key Path:	Meas Setup, Chan Profile Setup, Edit User Mapping, PUSCH
Help Map ID:	40878

Power Boost

Sets the Power Boost value for all the PUSCH Slots when Power Boost Couple is On and Detection is Manual.

Power Boost sets the PUSCH average power level relative to the 0 dB point set by the PUSCH DMRS Power.

Key Path:	Meas Setup, Chan Profile Setup, Edit User Mapping, PUSCH, Couple Power
Mode:	LTE, LTETDD
Remote Command:	[:SENSE] :EVM:ULINK:PROfile:USER<n>:PUSCh:PWRBoost <rel_ampl> [:SENSE] :EVM:ULINK:PROfile:USER<n>:PUSCh:PWRBoost?
Example:	EVM:ULIN:PROF:USER1:PUSC:PWRB 0 EVM:ULIN:PROF:USER1:PUSC:PWRB?
Notes:	Changes to this parameter will not be applied until Update Changes command is sent. See “RB Parameter Manager (Uplink)” on page 1073 section for more details.
Dependencies:	The range of sub op code <n> values is determined by the number of Users the user has configured. Max value for n = 50. If the user attempts to remotely set or query a sub op code that is out of range, this will result in an error message. Enabled when Detection is Manual, Power Boost Couple is On, and PUSCH Active is ON.
Preset:	0 dB
State Saved:	Saved in instrument state.
Min:	-100 dB
Max:	100 dB
Initial S/W Revision:	Prior to A.02.00
Modified at S/W Revision:	A.03.00, A.04.20
Help Map ID:	40879

LTE Modulation Analysis Measurement
Meas Setup (Measurement Setup)

Auto Detect Power Boost

Sets the Power Boost value for all the PUSCH Slots when Detection is Auto.

Key Path:	Meas Setup, Chan Profile Setup, Edit User Mapping, PUSCH,Couple Power
Mode:	LTE, LTETDD
Remote Command:	[:SENSe] :EVM:ULINk:PROFile:AUTO:PUSCh:PWRBoost <rel_amp1> [:SENSe] :EVM:ULINk:PROFile:AUTO:PUSCh:PWRBoost?
Example:	EVM:ULIN:PROF:AUTO:PUSC:PWRB 0 EVM:ULIN:PROF:AUTO:PUSC:PWRB?
Notes:	Changes to this parameter will not be applied until Update Changes command is sent. See “RB Parameter Manager (Uplink)” on page 1073 section for more details.
Dependencies:	Enabled when Detection is Auto and Auto Detect PUSCH Active is ON.
Preset:	0 dB
State Saved:	Saved in instrument state.
Min:	-100 dB
Max:	100 dB
Initial S/W Revision:	Prior to A.02.00
Modified at S/W Revision:	A.03.00, A.04.20
Help Map ID:	0

Power Boost Couple

Determines whether or not all the PUSCH Slots will use the Common Power Boost value.

Key Path:	Meas Setup, Chan Profile Setup, Edit User Mapping, PUSCH,Couple Power
Mode:	LTE, LTETDD
Remote Command:	[:SENSe] :EVM:ULINk:PROFile:USER<n>:PUSCh:PWRBoost :COUPl e OFF ON 0 1 [:SENSe] :EVM:ULINk:PROFile:USER<n>:PUSCh:PWRBoost :COUPl e
Example:	EVM:ULIN:PROF:USER1:PUSC:PWRB:COUP ON EVM:ULIN:PROF:USER1:PUSC:PWRB:COUP?
Notes:	Changes to this parameter will not be applied until Update Changes command is sent. See “RB Parameter Manager (Uplink)” on page 1073 section for more details.

Dependencies:	The range of sub op code <n> values is determined by the number of Users the user has configured. Max value for n = 50. If the user attempts to remotely set or query a sub op code that is out of range, this will result in an error message. Enabled when Detection is Manual.
Preset:	ON
State Saved:	Saved in instrument state.
Initial S/W Revision:	Prior to A.02.00
Modified at S/W Revision:	A.03.00
Help Map ID:	29297

Common DMRS Group

Specifies the DMRS Group for a slot.

Key Path:	Meas Setup, Chan Profile Setup, Edit User Mapping, PUSCH
Help Map ID:	40880

DMRS Group

Sets the DMRS Group for all the PUSCH Slots when DMRS Group Couple is On and when Detection is Manual.

Key Path:	Meas Setup, Chan Profile Setup, Edit User Mapping, PUSCH, DMRS Group
Mode:	LTE, LTETDD
Remote Command:	[:SENSE] :EVM:ULINk:PROFile:USER<n>:PUSCh:DMRS:GROup <integer> [:SENSE] :EVM:ULINk:PROFile:USER<n>:PUSCh:DMRS:GROup?
Example:	EVM:ULIN:PROF:USER1:PUSC:DMRS:GRO 1 EVM:ULIN:PROF:USER1:PUSC:DMRS:GRO?
Notes:	Changes to this parameter will not be applied until Update Changes command is sent. See “RB Parameter Manager (Uplink)” on page 1073 section for more details.
Dependencies:	The range of sub op code <n> values is determined by the number of Users the user has configured. Max value for n = 50.If the user attempts to remotely set or query a sub op code that is out of range, this will result in an error message. Enabled when Detection is Manual, DMRS Params is Off, DMRS Group Couple is On, and PUSCH Active is ON.
Preset:	0
State Saved:	Saved in instrument state.

LTE Modulation Analysis Measurement
Meas Setup (Measurement Setup)

Min:	0
Max:	29
Initial S/W Revision:	Prior to A.02.00
Modified at S/W Revision:	A.03.00
Help Map ID:	29229

Auto Detect DMRS Group

Sets the DMRS Group for all the PUSCH Slots when Detection is Auto.

Key Path:	Meas Setup, Chan Profile Setup, Edit User Mapping, PUSCH, DMRS Group
Mode:	LTE, LTETDD
Remote Command:	[:SENSe] :EVM:ULINk:PROFile:AUTO:PUSCh:DMRS:GROup <integer> [:SENSe] :EVM:ULINk:PROFile:AUTO:PUSCh:DMRS:GROup?
Example:	EVM:ULIN:PROF:AUTO:PUSC:DMRS:GRO 1 EVM:ULIN:PROF:AUTO:PUSC:DMRS:GRO?
Notes:	Changes to this parameter will not be applied until Update Changes command is sent. See “RB Parameter Manager (Uplink)” on page 1073 section for more details.
Dependencies:	Enabled when Detection is Auto, Auto Detect DMRS Params is Off, and Auto Detect PUSCH Active is ON.
Preset:	0
State Saved:	Saved in instrument state.
Min:	0
Max:	29
Initial S/W Revision:	Prior to A.02.00
Modified at S/W Revision:	A.03.00
Help Map ID:	0

DMRS Group Couple

Determines whether or not all the PUSCH Slots will use the Common DMRS Group value.

Key Path:	Meas Setup, Chan Profile Setup, Edit User Mapping, PUSCH,DMRS Group
Mode:	LTE, LTETDD

Remote Command:	[:SENSE] :EVM:ULINK:PROFile:USER<n>:PUSCh:DMRS:GROup:COUPle OFF ON 0 1 [:SENSE] :EVM:ULINK:PROFile:USER<n>:PUSCh:DMRS:GROup:COUPle?
Example:	EVM:ULIN:PROF:USER1:PUSC:DMRS:GRO:COUP ON EVM:ULIN:PROF:USER1:PUSC:DMRS:GRO:COUP?
Notes:	Changes to this parameter will not be applied until Update Changes command is sent. See “RB Parameter Manager (Uplink)” on page 1073 section for more details.
Dependencies:	The range of sub op code <n> values is determined by the number of Users the user has configured. Max value for n = 50. If the user attempts to remotely set or query a sub op code that is out of range, this will result in an error message. Enabled when Detection is Manual, DMRS Params is Off, PUSCH Active is ON, and PUSCH Active is ON.
Preset:	ON
State Saved:	Saved in instrument state.
Initial S/W Revision:	Prior to A.02.00
Modified at S/W Revision:	A.03.00
Help Map ID:	29230

Common DMRS Sequence

Specifies the DMRS Sequence for a slot.

Key Path:	Meas Setup, Chan Profile Setup, Edit User Mapping, PUSCH
Help Map ID:	40881

DMRS Sequence

Sets the DMRS Sequence (v) for all the PUSCH Slots when DMRS Sequence Couple is On and when Detection is Manual. DMRS Sequence or v, is the sequence number within the group and can take on values from 0 to $\text{floor}(N_{ZC}^{RS}/30)-1$, where N_{ZC}^{RS} is the largest prime number less than M_{SC}^{RS}

Key Path:	Meas Setup, Chan Profile Setup, Edit User Mapping, PUSCH, DMRS Seq
Mode:	LTE, LTETDD
Remote Command:	[:SENSE] :EVM:ULINK:PROFile:USER<n>:PUSCh:DMRS:SEQuence <integer> [:SENSE] :EVM:ULINK:PROFile:USER<n>:PUSCh:DMRS:SEQuence?
Example:	EVM:ULIN:PROF:USER1:PUSC:DMRS:SEQ 1 EVM:ULIN:PROF:USER1:PUSC:DMRS:SEQ?

LTE Modulation Analysis Measurement
Meas Setup (Measurement Setup)

Notes:	Changes to this parameter will not be applied until Update Changes command is sent. See “RB Parameter Manager (Uplink)” on page 1073 section for more details.
Dependencies:	The range of sub op code <n> values is determined by the number of Users the user has configured. Max value for n = 50. If the user attempts to remotely set or query a sub op code that is out of range, this will result in an error message. Enabled when Detection is Manual, DMRS Params is Off, DMRS Sequence Couple is On, and PUSCH Active is ON.
Preset:	0
State Saved:	Saved in instrument state.
Min:	0
Max:	1
Initial S/W Revision:	Prior to A.02.00
Modified at S/W Revision:	A.03.00
Help Map ID:	29231

Auto Detect DMRS Sequence

Sets the DMRS Sequence (v) for all the PUSCH Slots when Detection is Auto. DMRS Sequence or v, is the sequence number within the group and can take on values from 0 to $\text{floor}(N_{ZC}^{RS}/30)-1$, where N_{ZC}^{RS} is the largest prime number less than M_{SC}^{RS}

Key Path:	Meas Setup, Chan Profile Setup, Edit User Mapping, PUSCH,DMRS Seq
Mode:	LTE, LTETDD
Remote Command:	[:SENSe] :EVM:ULINk:PROFile:AUTO:PUSCh:DMRS:SEQuence <integer> [:SENSe] :EVM:ULINk:PROFile:AUTO:PUSCh:DMRS:SEQuence?
Example:	EVM:ULIN:PROF:AUTO:PUSC:DMRS:SEQ 1 EVM:ULIN:PROF:AUTO:PUSC:DMRS:SEQ?
Notes:	Changes to this parameter will not be applied until Update Changes command is sent. See “RB Parameter Manager (Uplink)” on page 1073 section for more details.
Dependencies:	Enabled when Detection is Auto, Auto Detect DMRS Params is Off, and Auto Detect PUSCH Active is ON.
Preset:	0
State Saved:	Saved in instrument state.
Min:	0

Max:	$\text{floor}(N_{ZC}^{RS}/30)-1$ (can be restricted based on bandwidth)
Initial S/W Revision:	Prior to A.02.00
Modified at S/W Revision:	A.03.00
Help Map ID:	0

DMRS Sequence Couple

Determines whether or not all the PUSCH Slots will use the Common DMRS Sequence value.

Key Path:	Meas Setup, Chan Profile Setup, Edit User Mapping, PUSCH, DMRS Seq
Mode:	LTE, LTETDD
Remote Command:	[:SENSe] :EVM:ULINk:PROfile:USER<n>:PUSCh:DMRS:SEQuence: COUPle OFF ON 0 1 [:SENSe] :EVM:ULINk:PROfile:USER<n>:PUSCh:DMRS:SEQuence: COUPle?
Example:	EVM:ULIN:PROF:USER1:PUSC:DMRS:SEQ:COUP ON EVM:ULIN:PROF:USER1:PUSC:DMRS:SEQ:COUP?
Notes:	Changes to this parameter will not be applied until Update Changes command is sent. See “RB Parameter Manager (Uplink)” on page 1073 section for more details.
Dependencies:	The range of sub op code <n> values is determined by the number of Users the user has configured. Max value for n = 50.If the user attempts to remotely set or query a sub op code that is out of range, this will result in an error message. Enabled when Detection is Manual, DMRS Params is OFF, and PUSCH Active is ON.
Preset:	ON
State Saved:	Saved in instrument state.
Initial S/W Revision:	Prior to A.02.00
Modified at S/W Revision:	A.03.00
Help Map ID:	29235

Common DMRS Cyclic Shift

Specifies the DMRS Cyclic Shift for a slot.

Key Path:	Meas Setup, Chan Profile Setup, Edit User Mapping, PUSCH
Help Map ID:	40882

LTE Modulation Analysis Measurement
Meas Setup (Measurement Setup)

DMRS Cyclic Shift

Sets the DMRS Cyclic Shift for all the PUSCH Slots when DMRS Cyclic Shift Couple is On and Detection is Manual.

Key Path:	Meas Setup, Chan Profile Setup, Edit User Mapping, PUSCH, DMRS Cyclic Shift Couple
Mode:	LTE, LTETDD
Remote Command:	[:SENSe] :EVM:ULINk:PROFile:USER<n>:PUSCh:DMRS:CSHift <integer> [:SENSe] :EVM:ULINk:PROFile:USER<n>:PUSCh:DMRS:CSHift?
Example:	EVM:ULIN:PROF:USER1:PUSC:DMRS:CSH 1 EVM:ULIN:PROF:USER1:PUSC:DMRS:CSH?
Notes:	Changes to this parameter will not be applied until Update Changes command is sent. See “RB Parameter Manager (Uplink)” on page 1073 section for more details.
Dependencies:	The range of sub op code <n> values is determined by the number of Users the user has configured. Max value for n = 50. If the user attempts to remotely set or query a sub op code that is out of range, this will result in an error message. Enabled when Detection is Manual, DMRS Params is Off, and DMRS Cyclic Shift Couple is On
Preset:	0
State Saved:	Saved in instrument state.
Min:	0
Max:	11
Initial S/W Revision:	Prior to A.02.00
Modified at S/W Revision:	A.03.00
Help Map ID:	29289

Auto Detect DMRS Cyclic Shift

Sets the DMRS Cyclic Shift for all the PUSCH Slots when Detection is Auto.

Key Path:	Meas Setup, Chan Profile Setup, Edit User Mapping, PUSCH,DMRS Cyclic Shift Couple
Mode:	LTE, LTETDD
Remote Command:	[:SENSe] :EVM:ULINk:PROFile:AUTO:PUSCh:DMRS:CSHift <integer> [:SENSe] :EVM:ULINk:PROFile:AUTO:PUSCh:DMRS:CSHift?

Example:	EVM:ULIN:PROF:AUTO:PUSC:DMRS:CSH 1 EVM:ULIN:PROF:AUTO:PUSC:DMRS:CSH?
Notes:	Changes to this parameter will not be applied until Update Changes command is sent. See “RB Parameter Manager (Uplink)” on page 1073 section for more details.
Dependencies:	Enabled when Detection is Auto and Auto Detect DMRS Params is Off.
Preset:	0
State Saved:	Saved in instrument state.
Min:	0
Max:	11
Initial S/W Revision:	Prior to A.02.00
Modified at S/W Revision:	A.03.00
Help Map ID:	0

DMRS Cyclic Shift Couple

Determines whether or not all the PUSCH Slots will use the Common DMRS Cyclic Shift value.

Key Path:	Meas Setup, Chan Profile Setup, Edit User Mapping, PUSCH,DMRS Cyclic Shift Couple
Mode:	LTE, LTETDD
Remote Command:	[:SENSE] :EVM:ULINK:PROF:USER<n>:PUSCh:DMRS:CSHift:COUPlE OFF ON 0 1 [:SENSE] :EVM:ULINK:PROF:USER<n>:PUSCh:DMRS:CSHift:COUPlE?
Example:	EVM:ULIN:PROF:USER1:PUSC:DMRS:CSH:COUP ON EVM:ULIN:PROF:USER1:PUSC:DMRS:CSH:COUP?
Notes:	Changes to this parameter will not be applied until Update Changes command is sent. See “RB Parameter Manager (Uplink)” on page 1073 section for more details.
Dependencies:	The range of sub op code <n> values is determined by the number of Users the user has configured. Max value for n = 50.If the user attempts to remotely set or query a sub op code that is out of range, this will result in an error message. Enabled when Detection is Manual, DMRS Params is Off, and PUSCH Active is ON.
Preset:	ON
State Saved:	Saved in instrument state.
Initial S/W Revision:	Prior to A.02.00

LTE Modulation Analysis Measurement
Meas Setup (Measurement Setup)

Modified at S/W Revision:	A.03.00
Help Map ID:	29290

Common DMRS Power Boost

Specifies the value to set DMRS power equal to for a slot.

Key Path:	Meas Setup, Chan Profile Setup, Edit User Mapping, PUSCH
Help Map ID:	40883

DMRS Power Boost

Sets the DMRS Power Boost value for all the PUSCH Slots when DMRS Power Boost Couple is On and Detection is Manual.

NOTE All channel and signal powers are relative to the power of the channel/signal chosen for synchronization.

For example, when PUSCH DMRS is chosen for synchronization, setting PUSCH DMRS Power = 2 dB and PUSCH Power = 0.1 dB means that the demodulator will expect PUSCH average power level to be 1.9 dB below the average DMRS power level.

Key Path:	Meas Setup, Chan Profile Setup, Edit User Mapping, PUSCH, Couple DMRS Power
Mode:	LTE, LTETDD
Remote Command:	[:SENSE] :EVM:ULINK:PROFile:USER<n>:PUSCh:DMRS:PWRBoost <rel_ampl> [:SENSE] :EVM:ULINK:PROFile:USER<n>:PUSCh:DMRS:PWRBoost?
Example:	EVM:ULIN:PROF:USER1:PUSC:DMRS:PWRB 0 EVM:ULIN:PROF:USER1:PUSC:DMRS:PWRB?
Notes:	Changes to this parameter will not be applied until Update Changes command is sent. See “RB Parameter Manager (Uplink)” on page 1073 section for more details.
Dependencies:	The range of sub op code <n> values is determined by the number of Users the user has configured. Max value for n = 50. If the user attempts to remotely set or query a sub op code that is out of range, this will result in an error message. Enabled when Detection is Manual, DMRS Power Boost Couple is ON, and PUSCH Active is ON.
Preset:	0 dB
State Saved:	Saved in instrument state.
Min:	-100 dB

Max:	100 dB
Initial S/W Revision:	Prior to A.02.00
Modified at S/W Revision:	A.03.00
Modified at S/W Revision:	A.04.20
Help Map ID:	30775

Auto Detect DMRS Power Boost

Sets the DMRS Power Boost value for all the PUSCH Slots when Detection is Auto.

Key Path:	Meas Setup, Chan Profile Setup, Edit User Mapping, PUSCH,Couple DMRS Power
Mode:	LTE, LTETDD
Remote Command:	[:SENSe] :EVM:ULINk:PROfile:AUTO:PUSCh:DMRS:PWRBoost <rel_ampl> [:SENSe] :EVM:ULINk:PROfile:AUTO:PUSCh:DMRS:PWRBoost?
Example:	EVM:ULIN:PROF:AUTO:PUSC:DMRS:PWRB 0 EVM:ULIN:PROF:AUTO:PUSC:DMRS:PWRB?
Notes:	Changes to this parameter will not be applied until Update Changes command is sent. See “ RB Parameter Manager (Uplink) ” on page 1073 section for more details.
Dependencies:	Enabled when Detection is Auto and Auto Detect PUSCH Active is ON.
Preset:	0 dB
State Saved:	Saved in instrument state.
Min:	-100 dB
Max:	100 dB
Initial S/W Revision:	Prior to A.02.00
Modified at S/W Revision:	A.03.00
Modified at S/W Revision:	A.04.20
Help Map ID:	0

DMRS Power Boost Couple

Determines whether or not all the PUSCH Slots will use the Common DMRS Power Boost value.

Key Path:	Meas Setup, Chan Profile Setup, Edit User Mapping, PUSCH,Couple DMRS Power
Mode:	LTE, LTETDD

LTE Modulation Analysis Measurement
Meas Setup (Measurement Setup)

Remote Command:	[:SENSe] :EVM:ULINk:PROFile:USER<n>:PUSCh:DMRS:PWRBoost:COUPle OFF ON 0 1 [:SENSe] :EVM:ULINk:PROFile:USER<n>:PUSCh:DMRS:PWRBoost:COUPle
Example:	EVM:ULIN:PROF:USER1:PUSC:DMRS:PWRB:COUP ON EVM:ULIN:PROF:USER1:PUSC:DMRS:PWRB:COUP?
Notes:	Changes to this parameter will not be applied until Update Changes command is sent. See “RB Parameter Manager (Uplink)” on page 1073 section for more details.
Dependencies:	The range of sub op code <n> values is determined by the number of Users the user has configured. Max value for n = 50. If the user attempts to remotely set or query a sub op code that is out of range, this will result in an error message. Enabled when Detection is Manual and PUSCH Active is ON.
Preset:	ON
State Saved:	Saved in instrument state.
Initial S/W Revision:	Prior to A.02.00
Modified at S/W Revision:	A.03.00
Help Map ID:	30776

Common CURRENT_TX_NB

Specifies whether or not allocation is mirrored.

Key Path:	Meas Setup, Chan Profile Setup, Edit User Mapping, PUSCH
Help Map ID:	40884

Common CURRENT_TX_NB

Selects CURRENT_TX_NB when Detection is Manual.

CUURRENT_TX_NB specifies whether or not allocation is mirrored.

Key Path:	Meas Setup, Chan Profile Setup, Edit User Mapping
Mode:	LTE, LTETDD
Remote Command:	[:SENSe] :EVM:ULINk:PROFile:USER1 50:PUSCh:CTNB EVEN ODD [:SENSe] :EVM:ULINk:PROFile:USER1 50:PUSCh:CTNB?
Remote Command:	[:SENSe] :EVM:ULINk:PROFile:USER<n>:PUSCh:CTNB EVEN ODD [:SENSe] :EVM:ULINk:PROFile:USER<n>:PUSCh:CTNB?

Example:	EVM:ULIN:PROF:USER1:PUSC:CTNB EVEN EVM:ULIN:PROF:USER1:PUSC:CTNB?
Notes:	Changes to this parameter will not be applied until Update Changes command is sent. See “RB Parameter Manager (Uplink)” on page 1073 section for more details.
Dependencies:	Enabled when Detection is Manual, PUSCH Active is ON, and CURRENT_TX_NB Couple is ON. Disabled when Intra/Inter-SF hopping is selected for Frequency Hopping Mode.
Preset:	EVEN
State Saved:	Saved in instrument state.
Range:	Even Odd
Initial S/W Revision:	A.03.00
Help Map ID:	40804

CURRENT_TX_NB Couple

Determines whether or not all the PUSCH Slots will use the Common CURRENT_TX_NB value.

Key Path:	Meas Setup, Chan Profile Setup, Edit User Mapping
Mode:	LTE, LTETDD
Remote Command:	[:SENSE] :EVM:ULINk:PROfile:USER<n> :PUSCh:CTNB:COUPle OFF ON 0 1 [:SENSE] :EVM:ULINk:PROfile:USER<n> :PUSCh:CTNB:COUPle?
Example:	EVM:ULIN:PROF:USER1:PUSC:CTNB:COUP OFF EVM:ULIN:PROF:USER1:PUSC:CTNB:COUP?
Notes:	Changes to this parameter is applied until Update Changes command is sent. See “RB Parameter Manager (Uplink)” on page 1073 section for more details.
Dependencies:	Enabled when Detection is Manual and PUSCH Active is ON.
Preset:	ON
State Saved:	Saved in instrument state.
Initial S/W Revision:	A.03.00
Help Map ID:	40805

PUSCH Slots Parameters

Sets all RB allocation for each slot.

Key Path:	Meas Setup, Chan Profile Setup, Edit User Mapping, PUSCH
-----------	---

Help Map ID:	40885
--------------	-------

Slot RB Start

Sets the Start Resource Block for the selected PUSCH Slot.

Key Path:	Meas Setup, Chan Profile Setup, Edit User Mapping, PUSCH, RB Start
Mode:	LTE, LTETDD
Remote Command:	[:SENSE] :EVM:ULINK:PROFile:USER<n>:PUSCh:SLOT<m>:RB:STARt <integer> [:SENSE] :EVM:ULINK:PROFile:USER<n>:PUSCh:SLOT<m>:RB:STARt?
Example:	EVM:ULIN:PROF:USER1:PUSC:SLOT0:RB:STAR 0 EVM:ULIN:PROF:USER1:PUSC:SLOT0:RB:STAR?
Notes:	The index <m> in the above SCPI command is the allocation index, not the slot position. See the “Add PUSCH Slot” on page 991 command for an explanation of the difference. Changes to this parameter will not be applied until Update Changes command is sent. See “RB Parameter Manager (Uplink)” on page 1073 section for more details.
Dependencies:	The range of sub op code <n> values is determined by the number of Users the user has configured. The range of sub op code <m> values is determined by the number of Slots the user has configured. . Max value for n=50. The range of sub op code <m> values is 0 – 19. If the user attempts to remotely set or query a sub op code that is out of range, this will result in an error message. Enabled when RB Start Couple is OFF and PUSCH Active is ON.
Couplings:	If the user attempts to set a RB Start value greater than the RB End value, both values will be set to the RB Start value or clipped to the min or max value if the entered value is out of range. Max value is dependent on Bandwidth.
Preset:	0
State Saved:	Saved in instrument state.
Min:	0
Max:	5 – Bandwidth 1.4 MHz 14 – Bandwidth 3 MHz 24 – Bandwidth 5 MHz 49 – Bandwidth 10 MHz 74 – Bandwidth 15 MHz 99 – Bandwidth 20 MHz

Initial S/W Revision:	Prior to A.02.00
Modified at S/W Revision:	A.03.00
Help Map ID:	29300

Slot RB End

Sets the Stop Resource Block for the selected PUSCH Slot.

Key Path:	Meas Setup, Chan Profile Setup, Edit User Mapping, PUSCH, RB End
Mode:	LTE, LTETDD
Remote Command:	[:SENSe] :EVM:ULINK:PROFile:USER<n>:PUSCh:SLOT<m>:RB:END <integer> [:SENSe] :EVM:ULINK:PROFile:USER<n>:PUSCh:SLOT<m>:RB:END ?
Example:	EVM:ULIN:PROF:USER1:PUSC:SLOT0:RB:END 0 EVM:ULIN:PROF:USER1:PUSC:SLOT0:RB:END?
Notes:	The index <m> in the above SCPI command is the allocation index, not the slot position. See the “Add PUSCH Slot” on page 991 command for an explanation of the difference. Changes to this parameter will not be applied until Update Changes command is sent. See “RB Parameter Manager (Uplink)” on page 1073 section for more details.
Dependencies:	The range of sub op code <n> values is determined by the number of Users the user has configured. The range of sub op code <m> values is determined by the number of Slots the user has configured. . Max value for n = 50. The range of sub op code <m> values is 0 – 19. If the user attempts to remotely set or query a sub op code that is out of range, this will result in an error message. Enabled when RB End Couple is OFF and PUSCH Active is ON.
Couplings:	If the user attempts to set a RB End value less than the RB Start value, both values will be set to the RB End value or clipped to the min or max value if the entered value is out of range. Max value is dependent on Bandwidth.
Preset:	0
State Saved:	Saved in instrument state.
Min:	0

LTE Modulation Analysis Measurement
Meas Setup (Measurement Setup)

Max:	5 – Bandwidth 1.4 MHz 14 – Bandwidth 3 MHz 24 – Bandwidth 5 MHz 49 – Bandwidth 10 MHz 74 – Bandwidth 15 MHz 99 – Bandwidth 20 MHz
Initial S/W Revision:	Prior to A.02.00
Modified at S/W Revision:	A.03.00
Help Map ID:	29301

Slot Mod Type

Selects the Modulation Type for the selected PUSCH Slot.

Key Path:	Meas Setup, Chan Profile Setup, Edit User Mapping, PUSCH, Mod Type
Mode:	LTE, LTETDD
Remote Command:	[:SENSE] :EVM:ULINK:PROFile:USER<n>:PUSCh:SLOT<m>:MODula tion:TYPE QPSK QAM16 QAM64 [:SENSE] :EVM:ULINK:PROFile:USER<n>:PUSCh:SLOT<m>:MODula tion:TYPE?
Example:	EVM:ULIN:PROF:USER1:PUSC:SLOT0:MOD:TYPE QPSK EVM:ULIN:PROF:USER1:PUSC:SLOT0:MOD:TYPE?
Notes:	The index <m> in the above SCPI command is the allocation index, not the slot position. See the “Add PUSCH Slot” on page 991 command for an explanation of the difference. Changes to this parameter will not be applied until Update Changes command is sent. See “RB Parameter Manager (Uplink)” on page 1073 section for more details.
Dependencies:	The range of sub op code <n> values is determined by the number of Users the user has configured. The range of sub op code <m> values is determined by the number of Slots the user has configured. . Max value for n = 50. The range of sub op code <m> values is 0 – 19. If the user attempts to remotely set or query a sub op code that is out of range, this will result in an error message. Enabled when Mod Type Couple is OFF and PUSCH Active is ON.
Preset:	QPSK
State Saved:	Saved in instrument state.
Range:	QPSK 16QAM 64QAM
Initial S/W Revision:	Prior to A.02.00

Modified at S/W Revision:	A.03.00
Help Map ID:	29302

QPSK

Selects QPSK for the Modulation Type of the selected PUSCH Slot.

Key Path:	Meas Setup, Chan Profile Setup, Edit User Mapping, PUSCH, Mod Type
Mode:	LTE, LTETDD
Initial S/W Revision:	Prior to A.02.00
Modified at S/W Revision:	A.03.00
Help Map ID:	Use 29164

16QAM

Selects 16QAM for the Modulation Type of the selected PUSCH Slot.

Key Path:	Meas Setup, Chan Profile Setup, Edit User Mapping, PUSCH, Mod Type
Mode:	LTE, LTETDD
Initial S/W Revision:	Prior to A.02.00
Modified at S/W Revision:	A.03.00
Help Map ID:	Use 29165

64QAM

Selects 64QAM for the Modulation Type of the selected PUSCH Slot.

Key Path:	Meas Setup, Chan Profile Setup, Edit User Mapping, PUSCH, Mod Type
Mode:	LTE, LTETDD
Initial S/W Revision:	Prior to A.02.00
Modified at S/W Revision:	A.03.00
Help Map ID:	29361

Slot Power Boost

Sets the Power Boost value for the selected PUSCH Slot.

Key Path:	Meas Setup, Chan Profile Setup, Edit User Mapping, PUSCH, Power Boost
Mode:	LTE, LTETDD

LTE Modulation Analysis Measurement
Meas Setup (Measurement Setup)

Remote Command:	[:SENSe] :EVM:ULINk:PROFile:USER<n>:PUSCh:SLOT<m>:PWRBoo st <rel_amp1> [:SENSe] :EVM:ULINk:PROFile:USER<n>:PUSCh:SLOT<m>:PWRBoo st?
Example:	EVM:ULIN:PROF:USER1:PUSC:SLOT0:PWRB 0 EVM:ULIN:PROF:USER1:PUSC:SLOT0:PWRB?
Notes:	The index <m> in the above SCPI command is the allocation index, not the slot position. See the “Add PUCCH Slot” on page 1037PUCCH Slot command for an explanation of the difference. Changes to this parameter will not be applied until Update Changes command is sent. See “RB Parameter Manager (Uplink)” on page 1073 section for more details.
Dependencies:	The range of sub op code <n> values is determined by the number of Users the user has configured. The range of sub op code <m> values is determined by the number of Slots the user has configured. . Max value for n = 50. The range of sub op code <m> values is 0 – 19. If the user attempts to remotely set or query a sub op code that is out of range, this will result in an error message. Enabled when Power Boost Couple is OFF and PUSCH Active is ON.
Preset:	0 dB
State Saved:	Saved in instrument state.
Min:	-100 dB
Max:	100 dB
Initial S/W Revision:	Prior to A.02.00
Modified at S/W Revision:	A.03.00
Modified at S/W Revision:	A.04.20
Help Map ID:	29306

Slot DMRS Group

Specifies the DMRS Group for the selected PUSCH Slot.

Key Path:	Meas Setup, Chan Profile Setup, Edit User Mapping, PUSCH,DMRS Group
Mode:	LTE, LTETDD
Remote Command:	[:SENSe] :EVM:ULINk:PROFile:USER<n>:PUSCh:SLOT<m>:DMRS:G ROup <integer> [:SENSe] :EVM:ULINk:PROFile:USER<n>:PUSCh:SLOT<m>:DMRS:G ROup?

Example:	EVM:ULIN:PROF:USER1:PUSC:SLOT0:DMRS:GRO 1 EVM:ULIN:PROF:USER1:PUSC:SLOT0:DMRS:GRO?
Notes:	The index <m> in the above SCPI command is the allocation index, not the slot position. See the “Add PUSCH Slot” on page 991 command for an explanation of the difference. Changes to this parameter will not be applied until Update Changes command is sent. See “RB Parameter Manager (Uplink)” on page 1073 section for more details.
Dependencies:	The range of sub op code <n> values is determined by the number of Users the user has configured. The range of sub op code <m> values is determined by the number of Slots the user has configured. . Max value for n = 50. The range of sub op code <m> values is 0 – 19.If the user attempts to remotely set or query a sub op code that is out of range, this will result in an error message. Enabled when DMRS Params is OFF, DMRS Group Couple is OFF, and PUSCH Active is ON.
Preset:	0
State Saved:	Saved in instrument state.
Min:	0
Max:	29
Initial S/W Revision:	Prior to A.02.00
Modified at S/W Revision:	A.03.00
Help Map ID:	29303

Slot DMRS Sequence

Specifies the DMRS Sequence (v) for the selected PUSCH. DMRS Sequence or v, is the sequence number within the group and can take on values from 0 to $\text{floor}(N_{ZC}^{RS}/30)-1$, where N_{ZC}^{RS} is the largest prime number less than M_{SC}^{RS}

Key Path:	Meas Setup, Chan Profile Setup, Edit User Mapping, PUSCH,DMRS Seq
Mode:	LTE, LTETDD
Remote Command:	[:SENSe] :EVM:ULINk:PROfile:USER<n>:PUSCh:SLOT<m>:DMRS:SEquence <integer> [:SENSe] :EVM:ULINk:PROfile:USER<n>:PUSCh:SLOT<m>:DMRS:SEquence?
Example:	EVM:ULIN:PROF:USER1:PUSC:SLOT0:DMRS:SEQ 1 EVM:ULIN:PROF:USER1:PUSC:SLOT0:DMRS:SEQ?

LTE Modulation Analysis Measurement
Meas Setup (Measurement Setup)

Notes:	<p>The index <m> in the above SCPI command is the allocation index, not the slot position. See the “Add PUSCH Slot” on page 991 command for an explanation of the difference.</p> <p>Changes to this parameter will not be applied until Update Changes command is sent. See “RB Parameter Manager (Uplink)” on page 1073 section for more details.</p>
Dependencies:	<p>The range of sub op code <n> values is determined by the number of Users the user has configured. The range of sub op code <m> values is determined by the number of Slots the user has configured. . Max value for n = 50. The range of sub op code <m> values is 0 – 19.</p> <p>If the user attempts to remotely set or query a sub op code that is out of range, this will result in an error message.</p> <p>Enabled when DMRS Params is OFF, DMRS Sequence Couple is OFF and PUSCH Active is ON.</p>
Preset:	0
State Saved:	Saved in instrument state.
Min:	0
Max:	$\text{floor}(N_{ZC}^{RS}/30)-1$ (can be restricted based on bandwidth)
Initial S/W Revision:	Prior to A.02.00
Modified at S/W Revision:	A.03.00
Help Map ID:	29304

Slot DMRS Cyclic Shift

Specifies the DMRS Cyclic Shift for the selected PUSCH Slot.

Key Path:	Meas Setup, Chan Profile Setup, Edit User Mapping, PUSCH,DMRS Cyclic Shift
Mode:	LTE, LTETDD
Remote Command:	<pre>[:SENSe] :EVM:ULINk:PROFile:USER<n>:PUSCh:SLOT<m>:DMRS:C SHift <integer></pre> <pre>[:SENSe] :EVM:ULINk:PROFile:USER<n>:PUSCh:SLOT<m>:DMRS:C SHift?</pre>
Example:	<pre>EVM:ULIN:PROF:USER1:PUSC:SLOT0:DMRS:CSH 1</pre> <pre>EVM:ULIN:PROF:USER1:PUSC:SLOT0:DMRS:CSH?</pre>
Notes:	<p>The index <m> in the above SCPI command is the allocation index, not the slot position. See the “Add PUSCH Slot” on page 991 command for an explanation of the difference.</p> <p>Changes to this parameter will not be applied until Update Changes command is sent. See “RB Parameter Manager (Uplink)” on page 1073 section for more details.</p>

Dependencies:	<p>The range of sub op code <n> values is determined by the number of Users the user has configured. The range of sub op code <m> values is determined by the number of Slots the user has configured. . Max value for n = 50. The range of sub op code <m> values is 0 – 19.</p> <p>If the user attempts to remotely set or query a sub op code that is out of range, this will result in an error message.</p> <p>Enabled when DMRS Params is OFF, DMRS Cyclic Shift Couple is OFF, and PUSCH Active is ON.</p>
Preset:	0
State Saved:	Saved in instrument state.
Min:	0
Max:	11
Initial S/W Revision:	Prior to A.02.00
Modified at S/W Revision:	A.03.00
Help Map ID:	29305

Slot DMRS Power Boost

Sets the DMRS Power Boost value for the selected PUSCH Slot.

Key Path:	Meas Setup, Chan Profile Setup, Edit User Mapping, PUSCH, DMRS Power Boost
Mode:	LTE, LTETDD
Remote Command:	<pre>[:SENSE] :EVM:ULINk:PROfile:USER<n>:PUSCh:SLOT<m>:DMRS:PWRBoost <rel_ampl></pre> <pre>[:SENSE] :EVM:ULINk:PROfile:USER<n>:PUSCh:SLOT<m>:DMRS:PWRBoost?</pre>
Example:	<pre>EVM:ULIN:PROF:USER1:PUSC:SLOT0:DMRS:PWRB 0</pre> <pre>EVM:ULIN:PROF:USER1:PUSC:SLOT0:DMRS:PWRB?</pre>
Notes:	<p>The index <m> in the above SCPI command is the allocation index, not the slot position. See the “Add PUSCH Slot” on page 991 command for an explanation of the difference.</p> <p>Changes to this parameter will not be applied until Update Changes command is sent. See “RB Parameter Manager (Uplink)” on page 1073 section for more details.</p>

LTE Modulation Analysis Measurement
Meas Setup (Measurement Setup)

Dependencies:	The range of sub op code <n> values is determined by the number of Users the user has configured. The range of sub op code <m> values is determined by the number of Slots the user has configured. . Max value for n = 50. The range of sub op code <m> values is 0 – 19. If the user attempts to remotely set or query a sub op code that is out of range, this will result in an error message. Enabled when DMRS Power Boost Couple is OFF and PUSCH Active is ON.
Preset:	0 dB
State Saved:	Saved in instrument state.
Min:	-100 dB
Max:	100 dB
Initial S/W Revision:	Prior to A.02.00
Modified at S/W Revision:	A.03.00
Modified at S/W Revision:	A.04.20
Help Map ID:	30779

Slot CURRENT_TX_NB

Sets the CURRENT_TX_NB for the selected PUSCH Slot.

Key Path:	Meas Setup, Chan Profile Setup, Edit User Mapping
Mode:	LTE, LTETDD
Remote Command:	[:SENSe] :EVM:ULINk:PROFile:USER<n>:PUSCh:SLOT<m>:CTNB OFF ON 0 1 [:SENSe] :EVM:ULINk:PROFile:USER<n>:PUSCh:SLOT<m>:CTNB?
Example:	EVM:ULIN:PROF:USER1:PUSC:SLOT0:CTNB OFF EVM:ULIN:PROF:USER1:PUSC:SLOT0:CTNB?
Notes:	The range of sub op code <n> values is determined by the number of Users the user has configured. The range of sub op code <m> values is determined by the number of Slots the user has configured. . Max value for n = 50. The range of sub op code <m> values is 0 – 19. Changes to this parameter will not be applied until Update Changes command is sent. See “RB Parameter Manager (Uplink)” on page 1073 section for more details.
Dependencies:	Enabled when Detection is Manual, Current TX NB Couple is OFF, and PUSCH Active is ON. Disabled when Intra/Inter-SF hopping is selected for Frequency Hopping Mode.
Preset:	EVEN

State Saved:	Saved in instrument state.
Range:	Even Odd
Initial S/W Revision:	A.03.00
Help Map ID:	40886

Add PUSCH Slot

Adds a new allocation in the slot position specified, if available. The new allocation will have its parameters set to the default values. It is put into a collection of allocations in ascending order of slot position. The SCPI commands that follow are used to set slot allocation parameters, such as RB start and end. They all contain the mnemonic SLOT<m>, where <m> is an index into the collection of allocations. The index ranges from 0 to a maximum of 19. Do not confuse the allocation index with the slot position.

To avoid confusion, you should make PUSCH allocations in ascending order of slot position.

For example, if you wished to add 4 allocations for User1 at slot positions 2, 4, 7, and 10, use the following commands in order:

```
EVM:ULIN:PROF:USER1:PUSC:ADD:SLOT 2
```

```
EVM:ULIN:PROF:USER1:PUSC:ADD:SLOT 4
```

```
EVM:ULIN:PROF:USER1:PUSC:ADD:SLOT 7
```

```
EVM:ULIN:PROF:USER1:PUSC:ADD:SLOT 10
```

You now have four allocations. Allocation 0 is at slot position 2, allocation 1 at slot position 4, allocation 2 at slot position 7, and allocation 3 at slot position 10. The allocations are referenced as SLOT0, SLOT1, SLOT2, and SLOT3 in the commands that follow. For example, if you want to verify the slot position of the third allocation, send the query:

```
EVM:ULIN:PROF:USER1:PUSC:SLOT2:POS?
```

This will return 7 for the example above.

Note that if you delete an allocation, the indices of the allocations above it reduce by 1. To continue the previous example, if you send the command:

```
EVM:ULIN:PROF:USER1:PUSC:SLOT1:DEL
```

This removes the allocation at slot position 4. The allocations at slot positions 7 and 10 are now referenced as SLOT1 and SLOT2, whereas before they were referenced as SLOT2 and SLOT3.

Key Path:	Meas Setup, Chan Profile Setup, Edit User Mapping, PUSCH, Slot
Mode:	LTE, LTETDD
Remote Command:	[:SENSe] :EVM:ULINk:PROFfile:USER<n>:PUSCh:ADD:SLOT <integer>
Example:	EVM:ULIN:PROF:USER1:PUSC:ADD:SLOT 0

LTE Modulation Analysis Measurement
Meas Setup (Measurement Setup)

Notes:	<p>The softkey for this parameter is an Immediate Action key. The value that is passed in by the SCPI command enables the user to position the allocation at a particular slot.</p> <p>Changes to this parameter will not be applied until Update Changes command is sent. See “RB Parameter Manager (Uplink)” on page 1073 section for more details.</p>
Dependencies:	<p>The range of sub op code <n> values is determined by the number of Users the user has configured.</p> <p>If the user attempts to add a Slot to a User and the slot is already allocated, an error message will be generated.</p> <p>Disabled once the number of Slots reaches to 20, the max number.</p>
Preset:	0
State Saved:	Saved in instrument state.
Min:	0
Max:	19
Initial S/W Revision:	Prior to A.02.00
Modified at S/W Revision:	A.03.00
Help Map ID:	29298

Delete PUSCH Slot

Deletes the currently selected slot allocation.

Key Path:	Meas Setup, Chan Profile Setup, Edit User Mapping, PUSCH, Slot
Mode:	LTE, LTETDD
Remote Command:	[:SENSE] :EVM:ULINK:PROFfile:USER<n>:PUSCh:SLOT<m>:DELeTe
Example:	EVM:ULIN:PROF:USER1:PUSC:SLOT1:DEL
Notes:	<p>The index <m> in the above SCPI command is the allocation index, not the slot position. See the “Add PUSCH Slot” on page 991 command for an explanation of the difference.</p> <p>Changes to this parameter will not be applied until Update Changes command is sent. See “RB Parameter Manager (Uplink)” on page 1073 section for more details.</p>
Dependencies:	<p>Disabled when there is only one Slot.</p> <p>The range of sub op code <n> values is determined by the number of Users the user has configured. The range of sub op code <m> values is determined by the number of Slots the user has configured. . Max value for n=50. The range of sub op code <m> values is 0 – 19.</p> <p>If the user attempts to delete a Slot that does not exist, an error message will be generated.</p>

Initial S/W Revision:	Prior to A.02.00
Modified at S/W Revision:	A.03.00
Help Map ID:	29299

Move Up

Moves the currently selected Slot up.

See also “Slot Position” on page 993 query

Key Path:	Meas Setup, Chan Profile Setup, Edit User Mapping, PUSCH, Slot
Mode:	LTE, LTETDD
Dependencies:	Disabled when there are no Slots defined or if the slot is at Slot19.
Initial S/W Revision:	Prior to A.02.00
Modified at S/W Revision:	A.03.00
Help Map ID:	30778

Move Down

Moves the currently selected Slot down .

See also “Slot Position” on page 993 query

Key Path:	Meas Setup, Chan Profile Setup, Edit User Mapping, PUSCH, Slot
Mode:	LTE, LTETDD
Dependencies:	Disabled when there are no Slots defined or if the slot is at Slot0.
Initial S/W Revision:	Prior to A.02.00
Modified at S/W Revision:	A.03.00
Help Map ID:	30777

Slot Position

Queries the PUSCH slot start position.

Key Path:	SCPI Only
Mode:	LTE, LTETDD
Remote Command:	[:SENSE] :EVM:ULINK:PROFile:USER<n>:PUSCh:SLOT<m>:POSiti on?
Example:	EVM:ULIN:PROF:USER1:PUSC:SLOT0:POS?
Notes:	The index <m> in the above SCPI command is the allocation index, not the slot position. See the “Add PUSCH Slot” on page 991 command for an explanation of the difference.

LTE Modulation Analysis Measurement
Meas Setup (Measurement Setup)

Dependencies:	The range of sub op code <n> values is determined by the number of Users the user has configured. The range of sub op code <m> values is determined by the number of Slots the user has configured. Max value for n = 50. The range of sub op code <m> values is 0 – 19.
Preset:	0
State Saved:	Saved in instrument state.
Min:	0
Max:	19
Initial S/W Revision:	Prior to A.02.00
Modified at S/W Revision:	A.03.00
Help Map ID:	0

PUCCH Parameters

Displays a menu that enables you to select PUCCH parameters for signals.

Key Path:	Meas Setup, Chan Profile Setup, Edit User Mapping, PUCCH Parameters
Mode:	LTE, LTETDD
Initial S/W Revision:	Prior to A.02.00
Modified at S/W Revision:	A.03.00
Help Map ID:	29110

PUCCH Active

Selects whether or not PUCCH exists in the input signal when Detection is Manual.

Key Path:	Meas Setup, Chan Profile Setup, Edit User Mapping
Mode:	LTE, LTETDD
Remote Command:	[:SENSe] :EVM:ULINk:PROFile:USER1 50:PUCCh:ACTive OFF ON 0 1 [:SENSe] :EVM:ULINk:PROFile:USER1 50:PUCCh:ACTive?
Example:	EVM:ULIN:PROF:USER1:PUCCh:ACT OFF EVM:ULIN:PROF:USER1:PUCCh:ACT?
Notes:	Changes to this parameter will not be applied until Update Changes command is sent. See “RB Parameter Manager (Uplink)” on page 1073 section for more details.
Dependencies:	Enabled when Detection is Manual. All soft keys for PUCCH parameter are grayed out when this parameter is OFF.

Preset:	OFF
State Saved:	Saved in instrument state.
Initial S/W Revision:	A.03.00
Help Map ID:	40822

Auto Detect PUCCH Active

Selects whether or not PUCCH exists in the input signal when Detection is Auto.

Key Path:	Meas Setup, Chan Profile Setup, Edit User Mapping
Mode:	LTE, LTETDD
Remote Command:	[:SENSE] :EVM:ULINK:PROfile:AUTO:PUCCh:ACTive OFF ON 0 1 [:SENSE] :EVM:ULINK:PROfile:AUTO:PUCCh:ACTive?
Example:	EVM:ULIN:PROF:AUTO:PUCCh:ACT OFF EVM:ULIN:PROF:AUTO:PUCCh:ACT?
Notes:	Changes to this parameter will not be applied until Update Changes command is sent. See “RB Parameter Manager (Uplink)” on page 1073 section for more details.
Dependencies:	Enabled when Detection is Auto.
Preset:	OFF
State Saved:	Saved in instrument state.
Initial S/W Revision:	A.03.00
Help Map ID:	0

DMRS Params

Determines if all DMRS parameters to be used are common to all Slots or if they are to be defined on a per Slot basis when Detection is Manual.

Enabling this parameter sets PUCCH Per-slot Parameters First RB, Cyclic Shift, OS, and DMRS Group (u) to be automatically calculated given the parameters $N_{RB}^{(2)}$, $N_{CS}^{(1)}$, $n_{PUCCH}^{(1)}$, $n_{PUCCH}^{(2)}$, D_{shift}^{PUCCH} parameters that are defined in 3GPP TS 36.211.

Key Path:	Meas Setup, Chan Profile Setup, Edit User Mapping, PUCCH, DMRS Params
Mode:	LTE, LTETDD
Remote Command:	[:SENSE] :EVM:ULINK:PROfile:USER<n>:PUCCh:DMRS:PARams OFF ON 0 1 [:SENSE] :EVM:ULINK:PROfile:USER<n>:PUCCh:DMRS:PARams?

LTE Modulation Analysis Measurement
Meas Setup (Measurement Setup)

Example:	EVM:ULIN:PROF:USER1:PUCCH:DMRS:PAR OFF EVM:ULIN:PROF:USER1:PUCCH:DMRS:PAR?
Notes:	Changes to this parameter will not be applied until Update Changes command is sent. See “RB Parameter Manager (Uplink)” on page 1073 section for more details.
Dependencies:	The range of sub op code <n> values is determined by the number of Users the user has configured. If the user attempts to remotely set or query a sub op code that is out of range, this will result in an error message. When this parameter is on, $N_{RB}(2)$, $N_{CS}(1)$, $n_{PUCCH}(1)$, $n_{PUCCH}(2)$, and PUCCH Shift are enabled and First RB, Cyclic Shift, OS and DMRS Group (u) are disabled. Enabled when Detection is Manual and PUCCH Active is ON.
Preset:	ON
State Saved:	Saved in instrument state.
Initial S/W Revision:	A.03.00
Help Map ID:	40816

Auto Detect DMRS Params

Determines if all DMRS parameters are common to all Slots for PUCCH or if they are to be defined on a per Slot basis when Detection is Auto.

Key Path:	Meas Setup, Chan Profile Setup, Edit User Mapping, PUCCH, DMRS Params
Mode:	LTE, LTETDD
Remote Command:	[:SENSe] :EVM:ULINK:PROF:Auto:PUCCh:DMRS:PARams OFF ON 0 1 [:SENSe] :EVM:ULINK:PROF:Auto:PUCCh:DMRS:PARams?
Example:	EVM:ULIN:PROF:AUTO:PUCCH:DMRS:PAR OFF EVM:ULIN:PROF:AUTO:PUCCH:DMRS:PAR?
Notes:	Changes to this parameter will not be applied until Update Changes command is sent. See “RB Parameter Manager (Uplink)” on page 1073 section for more details.
Dependencies:	When this parameter is on, $N_{RB}(2)$, $N_{CS}(1)$, $n_{PUCCH}(1)$, $n_{PUCCH}(2)$, and PUCCH Shift are enabled and First RB, Cyclic Shift, OS and DMRS Group (u) are disabled. Enabled when Detection is AUTO and Auto Detect PUCCH Active is ON.
Preset:	ON

State Saved:	Saved in instrument state.
Initial S/W Revision:	A.03.00
Help Map ID:	0

N RB (2)

Sets the $N_{RB}(2)$ for all PUCCH Slots when Detection is Manual.

$N_{RB}(2)$ specifies the number of resource blocks per slot that are available for PUCCH type 2/2a/2b transmissions.

Key Path:	Meas Setup, Chan Profile Setup, Edit User Mapping, PUCCH, N RB (2)
Mode:	LTE, LTETDD
Remote Command:	[:SENSe] :EVM:ULINk:PROFile:USER<n>:PUCCh:NRB:TWO <integer> [:SENSe] :EVM:ULINk:PROFile:USER<n>:PUCCh:NRB:TWO?
Example:	EVM:ULIN:PROF:USER1:PUCCh:NRB:TWO 1 EVM:ULIN:PROF:USER1:PUCCh:NRB:TWO?
Notes:	Changes to this parameter will not be applied until Update Changes command is sent. See “RB Parameter Manager (Uplink)” on page 1073 section for more details.
Dependencies:	The range of sub op code <n> values is determined by the number of Users the user has configured. If the user attempts to remotely set or query a sub op code that is out of range, this will result in an error message. Enabled when Detection is Manual, DMRS Params is On, and PUCCH Active is ON.
Couplings:	$N_{RB}(2)$ should always be less than the total RB number of selected Bandwidth Selection.
Preset:	0
State Saved:	Saved in instrument state.
Min:	0
Max:	5 – Bandwidth 1.4 MHz 14 – Bandwidth 3 MHz 24 – Bandwidth 5 MHz 49 – Bandwidth 10 MHz 74 – Bandwidth 15 MHz 99 – Bandwidth 20 MHz
Initial S/W Revision:	A.03.00

Help Map ID:	40817
--------------	-------

Auto Detect N RB (2)

Sets the $N_{RB}(2)$ for all PUCCH Slots when Detection is Auto.

Key Path:	Meas Setup, Chan Profile Setup, Edit User Mapping, PUCCH, N RB (2)
Mode:	LTE, LTETDD
Remote Command:	[:SENSe] :EVM:ULINk:PROFile:AUTO:PUCCh:NRB:TWO <integer> [:SENSe] :EVM:ULINk:PROFile:AUTO:PUCCh:NRB:TWO?
Example:	EVM:ULIN:PROF:AUTO:PUCCh:NRB:TWO 1 EVM:ULIN:PROF:AUTO:PUCCh:NRB:TWO?
Notes:	Changes to this parameter will not be applied until Update Changes command is sent. See “RB Parameter Manager (Uplink)” on page 1073 section for more details.
Dependencies:	If the user attempts to remotely set or query a sub op code that is out of range, this will result in an error message. Enabled when Detection is Auto, Auto Detect PUCCH DMRS Params is On, and Auto Detect PUCCH Active is ON.
Couplings:	$N_{RB}(2)$ should always be less than the total RB number of selected Bandwidth Selection.
Preset:	0
State Saved:	Saved in instrument state.
Min:	0
Max:	5 – Bandwidth 1.4 MHz 14 – Bandwidth 3 MHz 24 – Bandwidth 5 MHz 49 – Bandwidth 10 MHz 74 – Bandwidth 15 MHz 99 – Bandwidth 20 MHz
Initial S/W Revision:	A.03.00
Help Map ID:	0

N CS (1)

Sets the $N_{CS}(1)$ for all PUCCH Slots when Detection is Manual.

$N_{CS}(1)$ specifies the number of cyclic shifts used for PUCCH formats 1/1a/1b in a resource block with a mix of

formats 1/1a/1b and 2/2a/2b.

Key Path:	Meas Setup, Chan Profile Setup, Edit User Mapping, PUCCH, N CS (1)
Mode:	LTE, LTETDD
Remote Command:	[:SENSE] :EVM:ULINK:PROFile:USER<n>:PUCCh:NCS:ONE <integer> [:SENSE] :EVM:ULINK:PROFile:USER<n>:PUCCh:NCS:ONE?
Example:	EVM:ULIN:PROF:USER1:PUCCh:NCS:ONE 1 EVM:ULIN:PROF:USER1:PUCCh:NCS:ONE?
Notes:	Changes to this parameter will not be applied until Update Changes command is sent. See “RB Parameter Manager (Uplink)” on page 1073 section for more details.
Dependencies:	The range of sub op code <n> values is determined by the number of Users the user has configured. If the user attempts to remotely set or query a sub op code that is out of range, this will result in an error message. Enabled when Detection is Manual, DMRS Params is On, and PUCCH Active is ON.
Preset:	0
State Saved:	Saved in instrument state.
Min:	0
Max:	7
Initial S/W Revision:	A.03.00
Help Map ID:	40818

Auto Detect N CS (1)

Sets the $N_{CS}(1)$ for all PUCCH Slots when Detection is Auto.

Key Path:	Meas Setup, Chan Profile Setup, Edit User Mapping, PUCCH, N CS (1)
Mode:	LTE, LTETDD
Remote Command:	[:SENSE] :EVM:ULINK:PROFile:AUTO:PUCCh:NCS:ONE <integer> [:SENSE] :EVM:ULINK:PROFile:AUTO:PUCCh:NCS:ONE?
Example:	EVM:ULIN:PROF:AUTO:PUCCh:NCS:ONE 1 EVM:ULIN:PROF:AUTO:PUCCh:NCS:ONE?
Notes:	Changes to this parameter will not be applied until Update Changes command is sent. See “RB Parameter Manager (Uplink)” on page 1073 section for more details.

LTE Modulation Analysis Measurement
Meas Setup (Measurement Setup)

Dependencies:	If the user attempts to remotely set or query a sub op code that is out of range, this will result in an error message. Enabled when Detection is Auto, Auto Detect PUCCH DMRS Params is On, and Auto Detect PUCCH Active is ON.
Preset:	0
State Saved:	Saved in instrument state.
Min:	0
Max:	7
Initial S/W Revision:	A.03.00
Help Map ID:	0

N PUCCH (2)

Sets the $N_{PUCCH(2)}$ for all PUCCH Slots when Detection is Manual.

Key Path:	Meas Setup, Chan Profile Setup, Edit User Mapping, PUCCH, N PUCCH (2)
Mode:	LTE, LTETDD
Remote Command:	[:SENSe] :EVM:ULINk:PROFile:USER<n>:PUCCh:N:TWO <integer> [:SENSe] :EVM:ULINk:PROFile:USER<n>:PUCCh:N:TWO?
Example:	EVM:ULIN:PROF:USER1:PUCCh:N:TWO 1 EVM:ULIN:PROF:USER1:PUCCh:N:TWO?
Notes:	Changes to this parameter will not be applied until Update Changes command is sent. See “RB Parameter Manager (Uplink)” on page 1073 section for more details.
Dependencies:	The range of sub op code <n> values is determined by the number of Users the user has configured. If the user attempts to remotely set or query a sub op code that is out of range, this will result in an error message. Enabled when Detection is Manual, DMRS Params is On, and PUCCH Active is ON.
Couplings:	$N_{PUCCH(2)}$ should always be less than the total available subcarrier number of current bandwidth selection.
Preset:	0
State Saved:	Saved in instrument state.
Min:	0

Max:	$N_{\text{PUCCH}}^{(2)} < N_{\text{RB}}^{(2)} N_{\text{sc}}^{\text{RB}} + \left\lceil \frac{N_{\text{cs}}^{(1)}}{8} \right\rceil \cdot (N_{\text{sc}}^{\text{RB}} - N_{\text{cs}}^{(1)} - 2)$
Initial S/W Revision:	A.03.00
Help Map ID:	40820

Auto Detect N PUCCH (2)

Sets the $N_{\text{PUCCH}}^{(2)}$ for all PUCCH Slots when Detection is Auto.

Key Path:	Meas Setup, Chan Profile Setup, Edit User Mapping, PUCCH, N PUCCH (2)
Mode:	LTE, LTETDD
Remote Command:	[:SENSE] :EVM:ULINK:PROfile:AUTO:PUCCh:N:TWO <integer> [:SENSE] :EVM:ULINK:PROfile:AUTO:PUCCh:N:TWO?
Example:	EVM:ULIN:PROF:AUTO:PUCCh:N:TWO 1 EVM:ULIN:PROF:AUTO:PUCCh:N:TWO?
Notes:	Changes to this parameter will not be applied until Update Changes command is sent. See “RB Parameter Manager (Uplink)” on page 1073 section for more details.
Dependencies:	If the user attempts to remotely set or query a sub op code that is out of range, this will result in an error message. Enabled when Detection is Auto, Auto Detect PUCCH DMRS Params is On, and Auto Detect PUCCH Active is ON.
Couplings:	$N_{\text{PUCCH}}^{(2)}$ should always be less than the total available subcarrier number of current bandwidth selection.
Preset:	0
State Saved:	Saved in instrument state.
Min:	0
Max:	$N_{\text{PUCCH}}^{(2)} < N_{\text{RB}}^{(2)} N_{\text{sc}}^{\text{RB}} + \left\lceil \frac{N_{\text{cs}}^{(1)}}{8} \right\rceil \cdot (N_{\text{sc}}^{\text{RB}} - N_{\text{cs}}^{(1)} - 2)$
Initial S/W Revision:	A.03.00
Help Map ID:	0

LTE Modulation Analysis Measurement
Meas Setup (Measurement Setup)

PUCCH Shift

Sets the PUCCH Shift for all PUCCH Slots when Detection is Manual.

Key Path:	Meas Setup, Chan Profile Setup, Edit User Mapping, PUCCH, PUCCH Shift
Mode:	LTE, LTETDD
Remote Command:	[:SENSe] :EVM:ULINK:PROFile:USER<n>:PUCCh:SHIFt <integer> [:SENSe] :EVM:ULINK:PROFile:USER<n>:PUCCh:SHIFt?
Example:	EVM:ULIN:PROF:USER1:PUCCh:SHIF 1 EVM:ULIN:PROF:USER1:PUCCh:SHIF?
Notes:	Changes to this parameter will not be applied until Update Changes command is sent. See “RB Parameter Manager (Uplink)” on page 1073 section for more details.
Dependencies:	The range of sub op code <n> values is determined by the number of Users the user has configured. If the user attempts to remotely set or query a sub op code that is out of range, this will result in an error message. Enabled when Detection is Manual and PUCCH DMRS Params is On.
Preset:	1
State Saved:	Saved in instrument state.
Min:	1
Max:	3
Initial S/W Revision:	A.03.00
Help Map ID:	40821

Auto Detect PUCCH Shift

Sets the PUCCH Shift for all PUCCH Slots when Detection is Auto.

Key Path:	Meas Setup, Chan Profile Setup, Edit User Mapping, PUCCH, PUCCH Shift
Mode:	LTE, LTETDD
Remote Command:	[:SENSe] :EVM:ULINK:PROFile:AUTO:PUCCh:SHIFt <integer> [:SENSe] :EVM:ULINK:PROFile:AUTO:PUCCh:SHIFt?
Example:	EVM:ULIN:PROF:AUTO:PUCCh:SHIF 1 EVM:ULIN:PROF:AUTO:PUCCh:SHIF?

Notes:	Changes to this parameter will not be applied until Update Changes command is sent. See “RB Parameter Manager (Uplink)” on page 1073 section for more details.
Dependencies:	Enabled when Detection is Auto and Auto Detect PUCCH DMRS Params is On.
Preset:	1
State Saved:	Saved in instrument state.
Min:	1
Max:	3
Initial S/W Revision:	A.03.00
Help Map ID:	0

PUCCH Sync Slot

Sets the Sync Slot for all PUCCH Slots when Detection is Manual.

Sync Slot specifies the index of the slot to use for initial synchronization. The demodulator searches for the slot with the characteristics specified in Per-slot Parameters and the slot that matches the Per-slot Parameters with the highest correlation will be assigned the slot number given in the Sync Slot parameter.

When Sync Slot is set to Auto, the demod algorithm may automatically determine the best time slot to synchronise to. This approach simplifies parameter entry and provides easier setup. However, the complexity of the algorithm makes it rather slow and prone to errors in the presence of noise.

Key Path:	Meas Setup, Chan Profile Setup, Edit User Mapping
Mode:	LTE, LTETDD
Remote Command:	[:SENSe]:EVM:ULINk:PROFile:USER<n>:PUCCh:SSLot <integer> [:SENSe]:EVM:ULINk:PROFile:USER<n>:PUCCh:SSLot? [:SENSe]:EVM:ULINk:PROFile:USER<n>:PUCCh:SSLot:AUTO OFF ON 0 1 [:SENSe]:EVM:ULINk:PROFile:USER<n>:PUCCh:SSLot:AUTO?
Example:	EVM:ULIN:PROF:USER1:PUCCh:SSL 1 EVM:ULIN:PROF:USER1:PUCCh:SSL? EVM:ULIN:PROF:USER1:PUCCh:SSL:AUTO 1 EVM:ULIN:PROF:USER1:PUCCh:SSL:AUTO?
Notes:	Changes to this parameter will not be applied until Update Changes command is sent. See “RB Parameter Manager (Uplink)” on page 1073 section for more details.

LTE Modulation Analysis Measurement
Meas Setup (Measurement Setup)

Dependencies:	<p>The range of sub op code <n> values is determined by the number of Users the user has configured. Max value for n=50.</p> <p>If the user attempts to remotely set or query a sub op code that is out of range, this will result in an error message.</p> <p>PUCCH Sync Slot is enabled when Detection is Manual, PUCCH Active is ON, and PUCCH Sync Slot Auto is OFF.</p> <p>PUCCH Sync Slot Auto is enabled when Detection is Manual and PUCCH Active is ON.</p>
Preset:	0 ON
State Saved:	Saved in instrument state.
Min:	0
Max:	19
Initial S/W Revision:	Prior to A.02.00
Modified at S/W Revision:	A.03.00
Help Map ID:	30781

Auto Detect PUCCH Sync Slot

Sets the Sync Slot for all PUCCH Slots when Detection is Auto.

Key Path:	Meas Setup, Chan Profile Setup, Edit User Mapping
Mode:	LTE, LTETDD
Remote Command:	<pre>[:SENSe] :EVM:ULINk:PROFile:AUTO:PUCCh:SSLot <integer> [:SENSe] :EVM:ULINk:PROFile:AUTO:PUCCh:SSLot? [:SENSe] :EVM:ULINk:PROFile:AUTO:PUCCh:SSLot:AUTO OFF ON 0 1 [:SENSe] :EVM:ULINk:PROFile:AUTO:PUCCh:SSLot:AUTO?</pre>
Example:	<pre>EVM:ULIN:PROF:AUTO:PUCCh:SSL 1 EVM:ULIN:PROF:AUTO:PUCCh:SSL? EVM:ULIN:PROF:AUTO:PUCCh:SSL:AUTO 1 EVM:ULIN:PROF:AUTO:PUCCh:SSL:AUTO?</pre>
Notes:	Changes to this parameter will not be applied until Update Changes command is sent. See section 3.11.8.5.22 RB Parameter Manager (Uplink) for more details.

Dependencies:	Auto Detect PUCCH Sync Slot is enabled when Detection is Auto, Auto Detect PUCCH Active is ON, and Auto Detect PUCCH Sync Slot Auto is OFF. Auto Detect PUCCH Sync Slot Auto is enabled when Detection is Auto and Auto Detect PUCCH Active is ON, and “Auto-detect Format/nPUCCH(1)” on page 1005 nPUCCH(1) is Man.
Preset:	0 OFF
State Saved:	Saved in instrument state.
Min:	0
Max:	19
Initial S/W Revision:	Prior to A.02.00
Modified at S/W Revision:	A.03.00, A.10.00
Help Map ID:	0

Auto-detect Format/nPUCCH(1)

Enables auto detection of PUCCH Format and $n_{\text{PUCCH}}^{(1)}$ for all subframes. This is useful when the format and/or $n_{\text{PUCCH}}^{(1)}$ value is different for each subframe. When this parameter is set to Manual, if Detection is Auto, PUCCH parameters are auto detected, but PUCCH Format and $n_{\text{PUCCH}}^{(1)}$ are expected to be constant for the entire frame. When this parameter is set to AutoDet, the Auto Detect PUCCH Auto Sync setting will be ignored. When Sync Type is set to PUCCH DMRS, you must define a sync slot by setting the Per-Slot Parameters for the sync slot as well as setting the index using the Sync Slot parameter.

Key Path:	Meas Setup, Chan Profile Setup, Edit User Mapping
Mode:	LTE, LTETDD
Remote Command:	[:SENSE] :EVM:ULINK:PROFile:AUTO:PUCCh:FNPucch:AUTO OFF ON 0 1 [:SENSE] :EVM:ULINK:PROFile:AUTO:PUCCh:FNPucch:AUTO?
Example:	EVM:ULIN:PROF:AUTO:PUCC:FNP:AUTO 1 EVM:ULIN:PROF:AUTO:PUCC:FNP:AUTO?
Notes:	Changes to this parameter will not be applied until Update Changes command is sent. See section 3.11.8.5.22 RB Parameter Manager (Uplink) for more details.
Dependencies:	Enabled when Detection is Auto and Auto Detect PUCCH Active is ON.
Preset:	ON
State Saved:	Saved in instrument state.
Range:	AutoDet Man

LTE Modulation Analysis Measurement
Meas Setup (Measurement Setup)

Initial S/W Revision:	A.10.00
Help Map ID:	40771

PUCCH Couple

Selecting the checkbox next to a parameter in the PUCCH Per-slot Parameters area will couple that parameter across all RB allocation.

Key Path:	Meas Setup, Chan Profile Setup, Edit User Mapping, PUCCH
Help Map ID:	40887

Common First RB

Sets the RB index of the selected user's PUCCH allocation for this slot.

Key Path:	Meas Setup, Chan Profile Setup, Edit User Mapping, PUCCH
Help Map ID:	40888

First RB

Sets the First Resource Block for all the PUCCH Slots when First RB Couple is On and when Detection is Manual.

This value sets the RB index of the selected user's PUCCH allocation for this slot. The next or previous (see Notes below) slot's PUCCH allocation will automatically be set according to the LTE standard (mirrored in frequency).

For example, in a 5 MHz LTE signal (25 RBs), when Slot 0 contains a PUCCH allocation at RB 0, Slot 1 will be set to have a PUCCH allocation at RB 24.

NOTE A user can only have one RB allocated to PUCCH per slot.

 When Detection is Auto and Sync Slot is odd, this parameter sets the RB index for the second slot in a PUCCH subframe, causing the previous (instead of the next) slot to contain a mirrored PUCCH allocation for the current user.

See also: [“Auto Detect First RB” on page 1007](#)

Key Path:	Meas Setup, Chan Profile Setup, Edit User Mapping, PUCCH, First RB
Mode:	LTE, LTETDD
Remote Command:	[:SENSe] :EVM:ULINk:PROFile:USER<n>:PUCCh:RB <integer> [:SENSe] :EVM:ULINk:PROFile:USER<n>:PUCCh:RB?
Example:	EVM:ULIN:PROF:USER1:PUCCh:RB 0 EVM:ULIN:PROF:USER1:PUCCh:RB?
Notes:	Changes to this parameter will not be applied until Update Changes command is sent. See “RB Parameter Manager (Uplink)” on page 1073 section for more details.

Dependencies:	The range of sub op code <n> values is determined by the number of Users the user has configured. Max value for n = 50. If the user attempts to remotely set or query a sub op code that is out of range, this will result in an error message. Enabled when Detection is Manual, First RB Couple is ON, DMRS Params is OFF, and PUCCH Active is ON.
Couplings:	Max value dependent on Bandwidth.
Preset:	0
State Saved:	Saved in instrument state.
Min:	0
Max:	5 – Bandwidth 1.4 MHz 14 – Bandwidth 3 MHz 24 – Bandwidth 5 MHz 49 – Bandwidth 10 MHz 74 – Bandwidth 15 MHz 99 – Bandwidth 20 MHz
Initial S/W Revision:	Prior to A.02.00
Modified at S/W Revision:	A.03.00
Help Map ID:	29313

Auto Detect First RB

Sets the First Resource Block for all the PUCCH Slots when Detection is Auto.

Key Path:	Meas Setup, Chan Profile Setup, Edit User Mapping, PUCCH, First RB
Mode:	LTE, LTETDD
Remote Command:	[:SENSe] :EVM:ULINk:PROFile:AUTO:PUCCh:RB <integer> [:SENSe] :EVM:ULINk:PROFile:AUTO:PUCCh:RB?
Example:	EVM:ULIN:PROF:AUTO:PUC:RB 0 EVM:ULIN:PROF:AUTO:PUC:RB?
Notes:	Changes to this parameter will not be applied until Update Changes command is sent. See “RB Parameter Manager (Uplink)” on page 1073 section for more details.
Dependencies:	Enabled when Detection is Auto, First RB Couple is ON, Auto Detect DMRS Params is OFF, and Auto Detect PUCCH Active is ON.
Preset:	0
State Saved:	Saved in instrument state.

LTE Modulation Analysis Measurement
Meas Setup (Measurement Setup)

Min:	0
Max:	5 – Bandwidth 1.4 MHz 14 – Bandwidth 3 MHz 24 – Bandwidth 5 MHz 49 – Bandwidth 10 MHz 74 – Bandwidth 15 MHz 99 – Bandwidth 20 MHz
Initial S/W Revision:	Prior to A.02.00
Modified at S/W Revision:	A.03.00
Help Map ID:	0

First RB Couple

Determines whether or not all the PUCCH Slots will use the Common First RB value.

Key Path:	Meas Setup, Chan Profile Setup, Edit User Mapping, PUCCH, Couple First RB
Mode:	LTE, LTETDD
Remote Command:	[:SENSe] :EVM:ULINk:PROFile:USER<n>:PUCCh:RB:COUPle OFF ON 0 1 [:SENSe] :EVM:ULINk:PROFile:USER<n>:PUCCh:RB:COUPle?
Example:	EVM:ULIN:PROF:USER1:PUCC:RB:COUP ON EVM:ULIN:PROF:USER1:PUCC:RB:COUP?
Notes:	Changes to this parameter will not be applied until Update Changes command is sent. See “RB Parameter Manager (Uplink)” on page 1073 section for more details.
Dependencies:	The range of sub op code <n> values is determined by the number of Users the user has configured. Max value for n = 50. If the user attempts to remotely set or query a sub op code that is out of range, this will result in an error message. Enabled when Detection is Manual, DMRS Params is OFF, and PUCCH Active is ON.
Preset:	ON
State Saved:	Saved in instrument state.
Initial S/W Revision:	Prior to A.02.00
Modified at S/W Revision:	A.03.00
Help Map ID:	29314

Common Format

Selects the PUCCH Format type for all the PUCCH Slots when Format Couple is On.

Key Path:	Meas Setup, Chan Profile Setup, Edit User Mapping, PUCCH, Format
Mode:	LTE, LTETDD
Remote Command:	[:SENSe] :EVM:ULINk:PROFile:USER<n>:PUCCh:FORMat T1 T1A T1B T2 T2A T2B T1S T1AS T1BS [:SENSe] :EVM:ULINk:PROFile:USER<n>:PUCCh:FORMat?
Example:	EVM:ULIN:PROF:USER1:PUCC:FORM T1 EVM:ULIN:PROF:USER1:PUCC:FORM?
Notes:	Changes to this parameter will not be applied until Update Changes command is sent. See “RB Parameter Manager (Uplink)” on page 1073 section for more details.
Dependencies:	The range of sub op code <n> values is determined by the number of Users the user has configured. Max value for n = 50. If the user attempts to remotely set or query a sub op code that is out of range, this will result in an error message. Enabled when Detection is Manual and Format Couple is ON, and PUCCH Active is ON.
Preset:	T1
State Saved:	Saved in instrument state.
Range:	Type 1 Type 1a Type 1b Type 2 Type 2a Type 2b Type 1 Short Type 1a Short Type 1b Short
Initial S/W Revision:	Prior to A.02.00
Modified at S/W Revision:	A.03.00
Help Map ID:	29323

Auto Detect Format

Selects the PUCCH Format type for all the PUCCH Slots when Detection is Auto.

Key Path:	Meas Setup, Chan Profile Setup, Edit User Mapping, PUCCH, Format
Mode:	LTE, LTETDD
Remote Command:	[:SENSe] :EVM:ULINk:PROFile:AUTO:PUCCh:FORMat T1 T1A T1B T2 T2A T2B T1S T1AS T1BS [:SENSe] :EVM:ULINk:PROFile:AUTO:PUCCh:FORMat?
Example:	EVM:ULIN:PROF:AUTO:PUCC:FORM T1 EVM:ULIN:PROF:AUTO:PUCC:FORM?

LTE Modulation Analysis Measurement
Meas Setup (Measurement Setup)

Notes:	Changes to this parameter will not be applied until Update Changes command is sent. See “RB Parameter Manager (Uplink)” on page 1073 section for more details.
Dependencies:	Enabled when Detection is Auto and Auto Detect PUCCH Active is ON.
Preset:	T1
State Saved:	Saved in instrument state.
Range:	Type 1 Type 1a Type 1b Type 2 Type 2a Type 2b Type 1 Short Type 1a Short Type 1b Short
Initial S/W Revision:	Prior to A.02.00
Modified at S/W Revision:	A.03.00
Help Map ID:	0

Type 1

Selects Type 1 for the Format type for all the PUCCH Slots when Format Couple is On.

Key Path:	Meas Setup, Chan Profile Setup, Edit User Mapping, PUCCH, Format
Mode:	LTE, LTETDD
Initial S/W Revision:	Prior to A.02.00
Modified at S/W Revision:	A.03.00
Help Map ID:	40889

Type 1a

Selects Type 1a for the Format type for all the PUCCH Slots when Format Couple is On.

Key Path:	Meas Setup, Chan Profile Setup, Edit User Mapping, PUCCH, Format
Mode:	LTE, LTETDD
Initial S/W Revision:	Prior to A.02.00
Modified at S/W Revision:	A.03.00
Help Map ID:	40890

Type 1b

Selects Type 1b for the Format type for all the PUCCH Slots when Format Couple is On and when Detection is Manual.

Key Path:	Meas Setup, Chan Profile Setup, Edit User Mapping, PUCCH, Format
Mode:	LTE, LTETDD
Initial S/W Revision:	Prior to A.02.00

Modified at S/W Revision:	A.03.00
Help Map ID:	40891

Type 2

Selects Type 2 for the Format type for all the PUCCH Slots when Format Couple is On.

Key Path:	Meas Setup, Chan Profile Setup, Edit User Mapping, PUCCH, Format
Mode:	LTE, LTETDD
Initial S/W Revision:	Prior to A.02.00
Modified at S/W Revision:	A.03.00
Help Map ID:	40892

Type 2a

Selects Type 2a for the Format type for all the PUCCH Slots when Format Couple is On.

Key Path:	Meas Setup, Chan Profile Setup, Edit User Mapping, PUCCH, Format
Mode:	LTE, LTETDD
Initial S/W Revision:	Prior to A.02.00
Modified at S/W Revision:	A.03.00
Help Map ID:	40893

Type 2b

Selects Type 2b for the Format type for all the PUCCH Slots when Format Couple is On.

Key Path:	Meas Setup, Chan Profile Setup, Edit User Mapping, PUCCH, Format
Mode:	LTE, LTETDD
Initial S/W Revision:	Prior to A.02.00
Modified at S/W Revision:	A.03.00
Help Map ID:	40894

Type 1 Short

Selects Type 1 Short for the Format type for all the PUCCH Slots when Format Couple is On.

Key Path:	Meas Setup, Chan Profile Setup, Edit User Mapping, PUCCH, Format
Mode:	LTETDD
Initial S/W Revision:	A.03.00
Help Map ID:	40895

LTE Modulation Analysis Measurement
Meas Setup (Measurement Setup)

Type 1a Short

Selects Type 1a Short for the Format type for all the PUCCH Slots when Format Couple is On.

Key Path:	Meas Setup, Chan Profile Setup, Edit User Mapping, PUCCH, Format
Mode:	LTETDD
Initial S/W Revision:	A.03.00
Help Map ID:	40896

Type 1b Short

Selects Type 1b Short for the Format type for all the PUCCH Slots when Format Couple is On.

Key Path:	Meas Setup, Chan Profile Setup, Edit User Mapping, PUCCH, Format
Mode:	LTETDD
Initial S/W Revision:	A.03.00
Help Map ID:	40897

Common Format Couple

Determines whether or not all the PUCCH Slots will use the Common Format value.

Key Path:	Meas Setup, Chan Profile Setup, Edit User Mapping, PUCCH, Format
Mode:	LTE, LTETDD
Remote Command:	[:SENSE] :EVM:ULINK:PROFile:USER<n>:PUCCh:FORMat:COUPlE OFF ON 0 1 [:SENSE] :EVM:ULINK:PROFile:USER<n>:PUCCh:FORMat:COUPlE?
Example:	EVM:ULIN:PROF:USER1:PUCCh:FORM:COUP ON EVM:ULIN:PROF:USER1:PUCCh:FORM:COUP?
Notes:	Changes to this parameter will not be applied until Update Changes command is sent. See “RB Parameter Manager (Uplink)” on page 1073 section for more details.
Dependencies:	The range of sub op code <n> values is determined by the number of Users the user has configured. Max value for n = 50. If the user attempts to remotely set or query a sub op code that is out of range, this will result in an error message. Enabled when Detection is Manual and PUCCH Active is ON.
Preset:	ON
State Saved:	Saved in instrument state.
Initial S/W Revision:	Prior to A.02.00
Modified at S/W Revision:	A.03.00

Help Map ID:	29330
--------------	-------

Common Cyclic Shift

Sets PUCCH cyclic shift.

Key Path:	Meas Setup, Chan Profile Setup, Edit User Mapping, PUCCH
Help Map ID:	40898

Common Cyclic Shift

Sets the Cyclic Shift for all the PUCCH Slots when Cyclic Shift Couple is On and Auto Detect is Off.

Key Path:	Meas Setup, Chan Profile Setup, Edit User Mapping, PUCCH, Cyclic Shift
Mode:	LTE, LTETDD
Remote Command:	[:SENSe] :EVM:ULINk:PROFile:USER<n>:PUCCh:CSHift <integer> [:SENSe] :EVM:ULINk:PROFile:USER<n>:PUCCh:CSHift?
Example:	EVM:ULIN:PROF:USER1:PUCCh:CSH 1 EVM:ULIN:PROF:USER1:PUCCh:CSH
Notes:	Changes to this parameter will not be applied until Update Changes command is sent. See “RB Parameter Manager (Uplink)” on page 1073 section for more details.
Dependencies:	The range of sub op code <n> values is determined by the number of Users the user has configured. Max value for n = 50. If the user attempts to remotely set or query a sub op code that is out of range, this will result in an error message. Enabled when Detection is Manual, Cyclic Shift Couple is ON, DMRS Params is OFF, and PUCCH Active is ON.
Preset:	0
State Saved:	Saved in instrument state.
Min:	0
Max:	11
Initial S/W Revision:	Prior to A.02.00
Modified at S/W Revision:	A.03.00
Help Map ID:	30782

LTE Modulation Analysis Measurement
Meas Setup (Measurement Setup)

Auto Detect Cyclic Shift

Sets the Cyclic Shift for all the PUCCH Slots when Detection is Auto.

Key Path:	Meas Setup, Chan Profile Setup, Edit User Mapping, PUCCH, Cyclic Shift
Mode:	LTE, LTETDD
Remote Command:	[:SENSE] :EVM:ULINK:PROFile:AUTO:PUCCh:CSHift <integer> [:SENSE] :EVM:ULINK:PROFile:AUTO:PUCCh:CSHift?
Example:	EVM:ULIN:PROF:AUTO:PUCc:CSH 1 EVM:ULIN:PROF:AUTO:PUCc:CSH?
Notes:	Changes to this parameter will not be applied until Update Changes command is sent. See “RB Parameter Manager (Uplink)” on page 1073 section for more details. Enabled when Detection is Auto, Auto Detect DMRS Params is OFF and Auto Detect PUCCH Active is ON.
Preset:	0
State Saved:	Saved in instrument state.
Min:	0
Max:	11
Initial S/W Revision:	Prior to A.02.00
Modified at S/W Revision:	A.03.00
Help Map ID:	0

Cyclic Shift Couple

Determines whether or not all the PUCCH Slots will use the Common Cyclic Shift value.

Key Path:	Meas Setup, Chan Profile Setup, Edit User Mapping, PUCCH, Cyclic Shift
Mode:	LTE, LTETDD
Remote Command:	[:SENSE] :EVM:ULINK:PROFile:USER<n>:PUCCh:CSHift:COUPle OFF ON 0 1 [:SENSE] :EVM:ULINK:PROFile:USER<n>:PUCCh:CSHift:COUPle?
Example:	EVM:ULIN:PROF:USER1:PUCc:CSH:COUP ON EVM:ULIN:PROF:USER1:PUCc:CSH:COUP?
Notes:	Changes to this parameter will not be applied until Update Changes command is sent. See “RB Parameter Manager (Uplink)” on page 1073 section for more details.

Dependencies:	<p>The range of sub op code <n> values is determined by the number of Users the user has configured. Max value for n = 50.</p> <p>If the user attempts to remotely set or query a sub op code that is out of range, this will result in an error message.</p> <p>Enabled when Detection is Manual, DMRS Params is OFF, and PUCCH Active is ON.</p>
Preset:	ON
State Saved:	Saved in instrument state.
Initial S/W Revision:	Prior to A.02.00
Modified at S/W Revision:	A.03.00
Help Map ID:	30783

Common OS

Sets the Orthogonal Sequence index for all the PUCCH Slots when OS Couple is On and Detection is Auto.

Key Path:	Meas Setup, Chan Profile Setup, Edit User Mapping, PUCCH, OS
Mode:	LTE, LTETDD
Remote Command:	<pre>[:SENSe] :EVM:ULINK:PROFile:USER<n>:PUCCh:OS INDex0 INDex1 INDex2 [:SENSe] :EVM:ULINK:PROFile:USER<n>:PUCCh:OS?</pre>
Example:	<pre>EVM:ULIN:PROF:USER1:PUCCh:OS IND0 EVM:ULIN:PROF:USER1:PUCCh:OS?</pre>
Notes:	Changes to this parameter will not be applied until Update Changes command is sent. See “RB Parameter Manager (Uplink)” on page 1073 section for more details.
Dependencies:	<p>The range of sub op code <n> values is determined by the number of Users the user has configured. Max value for n = 50.</p> <p>If the user attempts to remotely set or query a sub op code that is out of range, this will result in an error message.</p> <p>Enabled when all the following conditions are met.</p> <p>Detection is Manual, DMRS Params is OFF, OS Couple is ON, PUCCH Active is ON, and Format is not Type2, Type 2a, Type 2b.</p>
Preset:	IND0
State Saved:	Saved in instrument state.

LTE Modulation Analysis Measurement
Meas Setup (Measurement Setup)

Range:	Index 0 Index1 Index2
Initial S/W Revision:	Prior to A.02.00
Modified at S/W Revision:	A.03.00
Help Map ID:	29321

Auto Detect OS

Sets the Orthogonal Sequence index for all the PUCCH Slots when Detection is Auto.

Key Path:	Meas Setup, Chan Profile Setup, Edit User Mapping, PUCCH, OS
Mode:	LTE, LTETDD
Remote Command:	[:SENSe] :EVM:ULINk:PROFile:AUTO:PUCCh:OS INDeX0 INDeX1 INDeX2 [:SENSe] :EVM:ULINk:PROFile:AUTO:PUCCh:OS?
Example:	EVM:ULIN:PROF:AUTO:PUCc:OS IND0 EVM:ULIN:PROF:AUTO:PUCc:OS?
Notes:	Changes to this parameter will not be applied until Update Changes command is sent. See “RB Parameter Manager (Uplink)” on page 1073 section for more details.
Dependencies:	Enabled when all the following conditions are met. Detection is Auto, Auto Detect DMRS Params is OFF, Auto Detect PUCCH Active is ON, and Auto Detect Format is not Type2, Type 2a, Type 2b.
Preset:	IND0
State Saved:	Saved in instrument state.
Range:	Index 0 Index1 Index2
Initial S/W Revision:	Prior to A.02.00
Modified at S/W Revision:	A.03.00
Help Map ID:	0

Index0

Selects Index0 for the OS for all the PUCCH Slots when OS Couple is On.

Key Path:	Meas Setup, Chan Profile Setup, Edit User Mapping, PUCCH, OS
Mode:	LTE, LTETDD
Initial S/W Revision:	Prior to A.02.00

Modified at S/W Revision:	A.03.00
Help Map ID:	30784

Index1

Selects Index1 for the OS for all the PUCCH Slots when OS Couple is On.

Key Path:	Meas Setup, Chan Profile Setup, Edit User Mapping, PUCCH, OS
Mode:	LTE, LTETDD
Initial S/W Revision:	Prior to A.02.00
Modified at S/W Revision:	A.03.00
Help Map ID:	30849

Index2

Selects Index2 for the OS for all the PUCCH Slots when OS Couple is On.

Key Path:	Meas Setup, Chan Profile Setup, Edit User Mapping, PUCCH, OS
Mode:	LTE, LTETDD
Initial S/W Revision:	Prior to A.02.00
Modified at S/W Revision:	A.03.00
Help Map ID:	30786

OS Couple

Determines whether or not all the PUCCH Slots will use the Common OS value.

Key Path:	Meas Setup, Chan Profile Setup, Edit User Mapping, PUCCH, OS
Mode:	LTE, LTETDD
Remote Command:	[:SENSE] :EVM:ULINK:PROF:USER<n>:PUCCh:OS:COUPle OFF ON 0 1 [:SENSe]:EVM:ULINK:PROF:USER<n>:PUCCh:OS:COUPle?
Example:	EVM:ULIN:PROF:USER1:PUCc:OS:COUP ON EVM:ULIN:PROF:USER1:PUCc:OS:COUP?
Notes:	Changes to this parameter will not be applied until Update Changes command is sent. See “RB Parameter Manager (Uplink)” on page 1073 section for more details.

LTE Modulation Analysis Measurement
Meas Setup (Measurement Setup)

Dependencies:	The range of sub op code <n> values is determined by the number of Users the user has configured. Max value for n = 50. If the user attempts to remotely set or query a sub op code that is out of range, this will result in an error message. Enabled when Detection is Manual, DMRS Params is OFF, and PUCCH Active is ON. .
Preset:	ON
State Saved:	Saved in instrument state.
Initial S/W Revision:	Prior to A.02.00
Modified at S/W Revision:	A.03.00
Help Map ID:	29322

Common Power

Sets the PUCCH average power level relative to the 0 dB point set by the PUCCH DMRS Power.

Key Path:	Meas Setup, Chan Profile Setup, Edit User Mapping, PUCCH
Help Map ID:	40900

Common Power Boost

Sets the Power Boost value for all the PUCCH Slots when Power Boost Couple is On and Auto Detect is Off.

Power Boost specifies the average PUCCH DMRS power for a slot.

NOTE All channel and signal powers are relative to the 0 dB level determined by the power of the channel/signal chosen for synchronization.

Key Path:	Meas Setup, Chan Profile Setup, Edit User Mapping, PUCCH, Couple Power Boost
Mode:	LTE, LTETDD
Remote Command:	[:SENSe] :EVM:ULINk:PROFile:USER<n>:PUCCh:PWRBoost <rel_ampl> [:SENSe] :EVM:ULINk:PROFile:USER<n>:PUCCh:PWRBoost?
Example:	EVM:ULIN:PROF:USER1:PUCCh:PWRB 0 EVM:ULIN:PROF:USER1:PUCCh:PWRB?
Notes:	Changes to this parameter will not be applied until Update Changes command is sent. See “RB Parameter Manager (Uplink)” on page 1073 section for more details.

Dependencies:	The range of sub op code <n> values is determined by the number of Users the user has configured. Max value for n = 50. If the user attempts to remotely set or query a sub op code that is out of range, this will result in an error message. Enabled when Power Boost Couple is On, Detection is Manual, and PUCCH Active is ON.
Preset:	0 dB
State Saved:	Saved in instrument state.
Min:	-100 dB
Max:	100 dB
Initial S/W Revision:	Prior to A.02.00
Modified at S/W Revision:	A.03.00, A.04.20
Help Map ID:	29331

Auto Detect Power Boost

Sets the Power Boost value for all the PUCCH Slots when Detection is Auto.

Key Path:	Meas Setup, Chan Profile Setup, Edit User Mapping, PUCCH, Couple Power Boost
Mode:	LTE, LTETDD
Remote Command:	[:SENSE] :EVM:ULINK:PROfile:AUTO:PUCCh:PWRBoost <rel_ampl> [:SENSE] :EVM:ULINK:PROfile:AUTO:PUCCh:PWRBoost?
Example:	EVM:ULIN:PROF:AUTO:PUCCh:PWRB 0 EVM:ULIN:PROF:AUTO:PUCCh:PWRB?
Notes:	Changes to this parameter will not be applied until Update Changes command is sent. See “RB Parameter Manager (Uplink)” on page 1073 section for more details.
Dependencies:	Enabled when Detection is Auto and Auto Detect PUCCH Active is ON.
Preset:	0 dB
State Saved:	Saved in instrument state.
Min:	-100 dB
Max:	100 dB
Initial S/W Revision:	Prior to A.02.00
Modified at S/W Revision:	A.03.00, A.04.20
Help Map ID:	0

LTE Modulation Analysis Measurement
Meas Setup (Measurement Setup)

Power Boost Couple

Determines whether or not all the PUCCH Slots will use the Common Power Boost value.

Key Path:	Meas Setup, Chan Profile Setup, Edit User Mapping, PUCCH, Power Boost
Mode:	LTE, LTETDD
Remote Command:	[:SENSe] :EVM:ULINk:PROFile:USER<n>:PUCCh:PWRBoost:COUPl e OFF ON 0 1 [:SENSe] :EVM:ULINk:PROFile:USER<n>:PUCCh:PWRBoost:COUPl e?
Example:	EVM:ULIN:PROF:USER1:PUCC:PWRB:COUP ON EVM:ULIN:PROF:USER1:PUCC:PWRB:COUP?
Notes:	Changes to this parameter will not be applied until Update Changes command is sent. See “RB Parameter Manager (Uplink)” on page 1073 section for more details.
Dependencies:	The range of sub op code <n> values is determined by the number of Users the user has configured. Max value for n = 50. If the user attempts to remotely set or query a sub op code that is out of range, this will result in an error message. Enabled when Detection is Manual, and PUCCH Active is ON.
Preset:	ON
State Saved:	Saved in instrument state.
Initial S/W Revision:	Prior to A.02.00
Modified at S/W Revision:	A.03.00
Help Map ID:	29332

Common DMRS Group

Sets the group number for the PUCCH demodulation reference signal (DMRS) when DMRS Group Couple is On and Detection is Manual.

Key Path:	Meas Setup, Chan Profile Setup, Edit User Mapping, PUCCH, DMRS Group
Mode:	LTE, LTETDD
Remote Command:	[:SENSe] :EVM:ULINk:PROFile:USER<n>:PUCCh:DMRS:GROUp <integer> [:SENSe] :EVM:ULINk:PROFile:USER<n>:PUCCh:DMRS:GROUp?
Example:	EVM:ULIN:PROF:USER1:PUCC:DMRS:GRO 1 EVM:ULIN:PROF:USER1:PUCC:DMRS:GRO?

Notes:	Changes to this parameter will not be applied until Update Changes command is sent. See “RB Parameter Manager (Uplink)” on page 1073 section for more details.
Dependencies:	The range of sub op code <n> values is determined by the number of Users the user has configured. Max value for n = 50. If the user attempts to remotely set or query a sub op code that is out of range, this will result in an error message. Enabled when Detection is Manual, DMRS Group Couple is ON, DMRS Params is OFF, and PUCCH Active is ON.
Preset:	0
State Saved:	Saved in instrument state.
Min:	0
Max:	29
Initial S/W Revision:	Prior to A.02.00
Modified at S/W Revision:	A.03.00
Help Map ID:	29317

Auto Detect DMRS Group

Sets the group number for the PUCCH demodulation reference signal (DMRS) when Detection is Auto.

Key Path:	Meas Setup, Chan Profile Setup, Edit User Mapping, PUCCH, DMRS Group
Mode:	LTE, LTETDD
Remote Command:	[:SENSe] :EVM:ULINk:PROFile:AUTO:PUCCh:DMRS:GROup <integer> [:SENSe] :EVM:ULINk:PROFile:AUTO:PUCCh:DMRS:GROup?
Example:	EVM:ULIN:PROF:AUTO:PUCCh:DMRS:GRO 1 EVM:ULIN:PROF:AUTO:PUCCh:DMRS:GRO?
Notes:	Changes to this parameter will not be applied until Update Changes command is sent. See “RB Parameter Manager (Uplink)” on page 1073 section for more details.
Dependencies:	Enabled when Detection is Auto, Auto Detect DMRS Params is OFF, and Auto Detect PUCCH Active is ON.
Preset:	0
State Saved:	Saved in instrument state.
Min:	0
Max:	29

LTE Modulation Analysis Measurement
Meas Setup (Measurement Setup)

Initial S/W Revision:	Prior to A.02.00
Modified at S/W Revision:	A.03.00
Help Map ID:	0

DMRS Group Couple

Determines whether or not all the PUCCH Slots will use the DMRS Group All value.

Key Path:	Meas Setup, Chan Profile Setup, Edit User Mapping, PUCCH,DMRS Group
Mode:	LTE, LTETDD
Remote Command:	[:SENSe] :EVM:ULINk:PROFile:USER<n>:PUCCh:DMRS:GROup:COUPle OFF ON 0 1 [:SENSe] :EVM:ULINk:PROFile:USER<n>:PUCCh:DMRS:GROup:COUPle?
Example:	EVM:ULIN:PROF:USER1:PUCC:DMRS:GRO:COUP ON EVM:ULIN:PROF:USER1:PUCC:DMRS:GRO:COUP?
Notes:	Changes to this parameter will not be applied until Update Changes command is sent. See “RB Parameter Manager (Uplink)” on page 1073 section for more details.
Dependencies:	The range of sub op code <n> values is determined by the number of Users the user has configured. Max value for n = 50. If the user attempts to remotely set or query a sub op code that is out of range, this will result in an error message. Enabled when Detection is Manual, DMRS Params is OFF and PUCCH Active is ON.
Preset:	ON
State Saved:	Saved in instrument state.
Initial S/W Revision:	Prior to A.02.00
Modified at S/W Revision:	A.03.00
Help Map ID:	29318

Common DMRS Power

Sets the power level for the PUCCH demodulation reference signal (DMRS) during the selected subframe.

Key Path:	Meas Setup, Chan Profile Setup, Edit User Mapping, PUCCH
Help Map ID:	40901

Common DMRS Power Boost

Sets the DMRS Power Boost value for all the PUCCH Slots when DMRS Power Boost Couple is On and Detection

is Manual.

This value sets the power level for the PUCCH demodulation reference signal (DMRS) of the selected subframe. PUCCH Power is set relative to the 0 dB point determined by this parameter.

For example, setting DMRS Power = 2 dB and PUCCH Power = 0.1 dB means that the demodulator will expect PUCCH average power level to be 1.9 dB below the average DMRS power level.

Key Path:	Meas Setup, Chan Profile Setup, Edit User Mapping, PUCCH, Couple DMRS Power Boost
Mode:	LTE, LTETDD
Remote Command:	[:SENSE] :EVM:ULINk:PROFile:USER<n>:PUCCh:DMRS:PWRBoost <rel_ampl> [:SENSE] :EVM:ULINk:PROFile:USER<n>:PUCCh:DMRS:PWRBoost?
Example:	EVM:ULIN:PROF:USER1:PUCc:PWRB 0 EVM:ULIN:PROF:USER1:PUCc:PWRB?
Notes:	Changes to this parameter will not be applied until Update Changes command is sent. See “RB Parameter Manager (Uplink)” on page 1073 section for more details.
Dependencies:	The range of sub op code <n> values is determined by the number of Users the user has configured. Max value for n = 50. If the user attempts to remotely set or query a sub op code that is out of range, this will result in an error message. Enabled when DMRS Power Boost Couple is On, Detection is Manual, and PUCCH Active is ON.
Preset:	0 dB
State Saved:	Saved in instrument state.
Min:	-100 dB
Max:	100 dB
Initial S/W Revision:	Prior to A.02.00
Modified at S/W Revision:	A.03.00
Modified at S/W Revision:	A.04.20
Help Map ID:	30787

Auto Detect DMRS Power Boost

Sets the DMRS Power Boost value for all the PUCCH Slots when Detection is Auto.

Key Path:	Meas Setup, Chan Profile Setup, Edit User Mapping, PUCCH, Couple DMRS Power Boost
Mode:	LTE, LTETDD

LTE Modulation Analysis Measurement
Meas Setup (Measurement Setup)

Remote Command:	[:SENSe] :EVM:ULINk:PROFile:AUTO:PUCCh:DMRS:PWRBoost <rel_amp1> [:SENSe] :EVM:ULINk:PROFile:AUTO:PUCCh:DMRS:PWRBoost?
Example:	EVM:ULIN:PROF:AUTO:PUC:PW RB 0 EVM:ULIN:PROF:AUTO:PUC:PW RB?
Notes:	Changes to this parameter will not be applied until Update Changes command is sent. See “RB Parameter Manager (Uplink)” on page 1073 section for more details.
Dependencies:	Enabled when Detection is Auto and Auto Detect PUCCH Active is ON.
Preset:	0 dB
State Saved:	Saved in instrument state.
Min:	-100 dB
Max:	100 dB
Initial S/W Revision:	Prior to A.02.00
Modified at S/W Revision:	A.03.00, A.04.20
Help Map ID:	0

DMRS Power Boost Couple

Determines whether or not all the PUCCH Slots will use the Common DMRS Power Boost value.

Key Path:	Meas Setup, Chan Profile Setup, Edit User Mapping, PUCCH, DMRS Power Boost
Mode:	LTE, LTETDD
Remote Command:	[:SENSe] :EVM:ULINk:PROFile:USER<n>:PUCCh:DMRS:PWRBoost:COUPle OFF ON 0 1 [:SENSe] :EVM:ULINk:PROFile:USER<n>:PUCCh:DMRS:PWRBoost:COUPle?
Example:	EVM:ULIN:PROF:USER1:PUC:DMRS:PW RB:COUP ON EVM:ULIN:PROF:USER1:PUC:DMRS:PW RB:COUP?
Notes:	Changes to this parameter will not be applied until Update Changes command is sent. See “RB Parameter Manager (Uplink)” on page 1073 section for more details.
Dependencies:	The range of sub op code <n> values is determined by the number of Users the user has configured. Max value for n = 50. If the user attempts to remotely set or query a sub op code that is out of range, this will result in an error message. Enabled when Detection is Manual and PUCCH Active is ON.
Preset:	ON

State Saved:	Saved in instrument state.
Initial S/W Revision:	Prior to A.02.00
Modified at S/W Revision:	A.03.00
Help Map ID:	30788

Common N PUCCH (1)

Key Path:	Meas Setup, Chan Profile Setup, Edit User Mapping, PUCCH
Help Map ID:	40902

Common N PUCCH (1)

Sets the $n_{\text{PUCCH}}(1)$ for all PUCCH Slots when Detection is Manual.

Key Path:	Meas Setup, Chan Profile Setup, Edit User Mapping, PUCCH, N PUCCH (1)
Mode:	LTE, LTETDD
Remote Command:	[:SENSE] :EVM:ULINK:PROfile:USER<n>:PUCCh:N:ONE <integer> [:SENSE] :EVM:ULINK:PROfile:USER<n>:PUCCh:N:ONE?
Example:	EVM:ULIN:PROF:USER1:PUCCh:N:ONE 1 EVM:ULIN:PROF:USER1:PUCCh:N:ONE?
Notes:	Changes to this parameter will not be applied until Update Changes command is sent. See “RB Parameter Manager (Uplink)” on page 1073 section for more details.
Dependencies:	The range of sub op code <n> values is determined by the number of Users the user has configured. If the user attempts to remotely set or query a sub op code that is out of range, this will result in an error message. Enabled when Detection is Manual, DMRS Params is On, and PUCCH Active is ON.
Couplings:	$n_{\text{PUCCH}}(1)$ should always be less than the total available subcarrier number of current bandwidth selection.
Preset:	0
State Saved:	Saved in instrument state.
Min:	0
Max:	1199
Initial S/W Revision:	A.03.00
Modified at S/W Revision:	A.06.00

Help Map ID:	40819
--------------	-------

Auto Detect N PUCCH (1)

Sets the $n_{PUCCH}(1)$ for all PUCCH Slots when Detection is Auto.

Key Path:	Meas Setup, Chan Profile Setup, Edit User Mapping, PUCCH, N PUCCH (1)
Mode:	LTE, LTETDD
Remote Command:	[:SENSe] :EVM:ULINK:PROFile:AUTO:PUCCh:N:ONE <integer> [:SENSe] :EVM:ULINK:PROFile:AUTO:PUCCh:N:ONE?
Example:	EVM:ULIN:PROF:AUTO:PUCCh:N:ONE 1 EVM:ULIN:PROF:AUTO:PUCCh:N:ONE?
Notes:	Changes to this parameter will not be applied until Update Changes command is sent. See “RB Parameter Manager (Uplink)” on page 1073 section for more details.
Dependencies:	If the user attempts to remotely set or query a sub op code that is out of range, this will result in an error message. Enabled when Detection is Auto, Auto Detect PUCCH DMRS Params is On, and Auto Detect PUCCH Active is ON.
Couplings:	$n_{PUCCH}(1)$ should always be less than the total available subcarrier number of current bandwidth selection.
Preset:	0
State Saved:	Saved in instrument state.
Min:	0
Max:	1199
Initial S/W Revision:	A.03.00
Modified at S/W Revision:	A.06.00
Help Map ID:	0

N PUCCH (1) Couple

Determines whether or not all the PUCCH Slots will use the Common N PUCCH (1) value.

Key Path:	Meas Setup, Chan Profile Setup, Edit User Mapping, PUCCH
Mode:	LTE, LTETDD
Remote Command:	[:SENSe] :EVM:ULINK:PROFile:USER<n>:PUCCh:N:ONE:COUPlE OFF ON 0 1 [:SENSe] :EVM:ULINK:PROFile:USER<n>:PUCCh:N:ONE:COUPlE?

Example:	EVM:ULIN:PROF:USER1:PUC: N:ONE:COUP ON EVM:ULIN:PROF:USER1:PUC: N:ONE:COUP?
Notes:	Changes to this parameter will not be applied until Update Changes command is sent. See RB Parameter Manager (Uplink) section for more details.
Dependencies:	The range of sub op code <n> values is determined by the number of Users the user has configured. Max value for n = 50. If the user attempts to remotely set or query a sub op code that is out of range, this will result in an error message. Enabled when Detection is Manual, PUCCH Active is ON and PUCCH DMRS Params is ON.
Preset:	ON
State Saved:	Saved in instrument state.
Initial S/W Revision:	A.06.00
Help Map ID:	29247

PUCCH Slot Parameters

Sets all RB allocation for each slot.

Key Path:	Meas Setup, Chan Profile Setup, Edit User Mapping, PUCCH
Help Map ID:	40903

Slot First RB

Sets the First Resource Block for the selected PUCCH slot allocation. Note that you can only set the first RB on even numbered slot allocations. The RB for the paired odd allocations are automatically set according to the constraints set by the LTE standard.

Key Path:	Meas Setup, Chan Profile Setup, Edit User Mapping, PUCCH, RB
Mode:	LTE, LTETDD
Remote Command:	[:SENSe] :EVM:ULINk:PROFile:USER<n>:PUCCh:SLOT<m>:RB <integer> [:SENSe] :EVM:ULINk:PROFile:USER<n>:PUCCh:SLOT<m>:RB?
Example:	EVM:ULIN:PROF:USER1:PUC: SLO T0:RB 0 EVM:ULIN:PROF:USER1:PUC: SLO T0:RB?
Notes:	The index <m> in the above SCPI command is the allocation index, not the slot position. See the “Add PUCCH Slot” on page 1037 PUCCH Slot command for an explanation of the difference. Changes to this parameter will not be applied until Update Changes command is sent. See “RB Parameter Manager (Uplink)” on page 1073 section for more details.

LTE Modulation Analysis Measurement
Meas Setup (Measurement Setup)

Dependencies:	<p>The range of sub op code <n> values is determined by the number of Users the user has configured. The range of sub op code <m> values is determined by the number of Slots the user has configured. Max value for n= 50. The range of sub op code <m> values is 0 – 19.</p> <p>If the user attempts to set the RB for an odd numbered slot, the command returns an error. However, odd slots may be queried.</p> <p>If the user attempts to remotely set or query a sub op code that is out of range, this will result in an error message.</p> <p>Disabled when the slot is odd indexed.</p> <p>Enabled when First RB Couple is OFF, PUCCH DMRS Params is Off, and PUCCH Active is ON.</p>
Couplings:	Max value dependent on Bandwidth.
Preset:	0
State Saved:	Saved in instrument state.
Min:	0
Max:	<p>5 – Bandwidth 1.4 MHz</p> <p>14 – Bandwidth 3 MHz</p> <p>24 – Bandwidth 5 MHz</p> <p>49 – Bandwidth 10 MHz</p> <p>74 – Bandwidth 15 MHz</p> <p>99 – Bandwidth 20 MHz</p>
Initial S/W Revision:	Prior to A.02.00
Modified at S/W Revision:	A.03.00
Help Map ID:	29335

Slot Format

Selects the PUCCH Format type to be used for the selected PUCCH Slot.

Key Path:	Meas Setup, Chan Profile Setup, Edit User Mapping, PUCCH, Format
Mode:	LTE, LTETDD
Remote Command:	<p>[:SENSe] :EVM:ULINk:PROFile:USER<n>:PUCCh:SLOT<m>:FORMat T1 T1A T1B T2 T2A T2B T1S T1AS T1BS</p> <p>[:SENSe] :EVM:ULINk:PROFile:USER<n>:PUCCh:SLOT<m>:FORMat ?</p>
Example:	<p>EVM:ULIN:PROF:USER1:PUCC:SLOT0:FORMAT T1</p> <p>EVM:ULIN:PROF:USER1:PUCC:SLOT0:FORMAT?</p>

Notes:	<p>The index <m> in the above SCPI command is the allocation index, not the slot position. See the “Add PUCCH Slot” on page 1037 PUCCH Slot command for an explanation of the difference.</p> <p>Changes to this parameter will not be applied until Update Changes command is sent. See “RB Parameter Manager (Uplink)” on page 1073 section for more details.</p>
Dependencies:	<p>The range of sub op code <n> values is determined by the number of Users the user has configured. The range of sub op code <m> values is determined by the number of Slots the user has configured. . Max value for n=50. The range of sub op code <m> values is 0 – 19.</p> <p>If the user attempts to remotely set or query a sub op code that is out of range, this will result in an error message.</p> <p>Enabled when Format Couple is OFF.</p>
Preset:	T1
State Saved:	Saved in instrument state.
Range:	Type 1 Type 1a Type 1b Type 2 Type 2a Type 2b Type 1 Short Type 1a Short Type 1b Short
Initial S/W Revision:	Prior to A.02.00
Modified at S/W Revision:	A.03.00
Help Map ID:	29340

Type 1

Selects Type 1 for the Format type for the selected PUCCH Slot.

Key Path:	Meas Setup, Chan Profile Setup, Edit User Mapping, PUCCH, Format
Mode:	LTE, LTETDD
Initial S/W Revision:	Prior to A.02.00
Modified at S/W Revision:	A.03.00
Help Map ID:	29341

Type 1a

Selects Type 1a for the Format type for the selected PUCCH Slot.

Key Path:	Meas Setup, Chan Profile Setup, Edit User Mapping, PUCCH, Format
Mode:	LTE, LTETDD
Initial S/W Revision:	Prior to A.02.00
Modified at S/W Revision:	A.03.00
Help Map ID:	29342

LTE Modulation Analysis Measurement
Meas Setup (Measurement Setup)

Type 1b

Selects Type 1b for the Format type for the selected PUCCH Slot.

Key Path:	Meas Setup, Chan Profile Setup, Edit User Mapping, PUCCH, Format
Mode:	LTE, LTETDD
Initial S/W Revision:	Prior to A.02.00
Modified at S/W Revision:	A.03.00
Help Map ID:	29343

Type 2

Selects Type 2 for the Format type for the selected PUCCH Slot.

Key Path:	Meas Setup, Chan Profile Setup, Edit User Mapping, PUCCH, Format
Mode:	LTE, LTETDD
Initial S/W Revision:	Prior to A.02.00
Modified at S/W Revision:	A.03.00
Help Map ID:	29344

Type 2a

Selects Type 2a for the Format type for the selected PUCCH Slot.

Key Path:	Meas Setup, Chan Profile Setup, Edit User Mapping, PUCCH, Format
Mode:	LTE, LTETDD
Initial S/W Revision:	Prior to A.02.00
Modified at S/W Revision:	A.03.00
Help Map ID:	29345

Type 2b

Selects Type 2b for the Format type for the selected PUCCH Slot.

Key Path:	Meas Setup, Chan Profile Setup, Edit User Mapping, PUCCH, Format
Mode:	LTE, LTETDD
Initial S/W Revision:	Prior to A.02.00
Modified at S/W Revision:	A.03.00
Help Map ID:	29346

Type 1 Short

Selects Type 1 Short for the Format type for the selected PUCCH Slot.

Key Path:	Meas Setup, Chan Profile Setup, Edit User Mapping, PUCCH, Format
Mode:	LTE, LTETDD
Initial S/W Revision:	A.03.00
Help Map ID:	40823

Type 1a Short

Selects Type 1a Short for the Format type for the selected PUCCH Slot.

Key Path:	Meas Setup, Chan Profile Setup, Edit User Mapping, PUCCH, Format
Mode:	LTE, LTETDD
Initial S/W Revision:	A.03.00
Help Map ID:	40824

Type 1b Short

Selects Type 1b Short for the Format type for the selected PUCCH Slot.

Key Path:	Meas Setup, Chan Profile Setup, Edit User Mapping, PUCCH, Format
Mode:	LTE, LTETDD
Initial S/W Revision:	A.03.00
Help Map ID:	40825

Slot Cyclic Shift

Sets the Cyclic Shift for the selected PUCCH Slot.

Key Path:	Meas Setup, Chan Profile Setup, Edit User Mapping, PUCCH, Cyclic Shift
Mode:	LTE, LTETDD
Remote Command:	[:SENSE] :EVM:ULINk:PROFile:USER<n>:PUCCh:SLOT<m>:CSHift <integer> [:SENSE] :EVM:ULINk:PROFile:USER<n>:PUCCh:SLOT<m>:CSHift ?
Example:	EVM:ULIN:PROF:USER1:PUCC:SLOT0:CSH 1 EVM:ULIN:PROF:USER1:PUCC:SLOT0:CSH?

LTE Modulation Analysis Measurement
Meas Setup (Measurement Setup)

Notes:	<p>The index <m> in the above SCPI command is the allocation index, not the slot position. See the “Add PUCCH Slot” on page 1037PUCCH Slot command for an explanation of the difference.</p> <p>Changes to this parameter will not be applied until Update Changes command is sent. See “RB Parameter Manager (Uplink)” on page 1073 section for more details.</p>
Dependencies:	<p>The range of sub op code <n> values is determined by the number of Users the user has configured. The range of sub op code <m> values is determined by the number of Slots the user has configured. . Max value for n=50. The range of sub op code <m> values is 0 – 19.</p> <p>If the user attempts to remotely set or query a sub op code that is out of range, this will result in an error message.</p> <p>Enabled when Cyclic Shift Couple is OFF, PUCCh DMRS Params is OFF and PUCCH Active is ON</p>
Preset:	0
State Saved:	Saved in instrument state.
Min:	0
Max:	11
Initial S/W Revision:	Prior to A.02.00
Modified at S/W Revision:	A.03.00
Help Map ID:	30791

Slot OS

Sets the Orthogonal Sequence index for the selected PUCCH Slot.

Key Path:	Meas Setup, Chan Profile Setup, Edit User Mapping, PUCCH, OS
Mode:	LTE, LTETDD
Remote Command:	<pre>[:SENSe] :EVM:ULINk:PROFile:USER<n>:PUCCh:SLOT<m>:OS INDeX0 INDeX1 INDeX2</pre> <pre>[:SENSe] :EVM:ULINk:PROFile:USER<n>:PUCCh:SLOT<m>:OS?</pre>
Example:	<pre>EVM:ULIN:PROF:USER1:PUCCh:SLOT0:OS INDeX0</pre> <pre>EVM:ULIN:PROF:USER1:PUCCh:SLOT0:OS?</pre>
Notes:	<p>The index <m> in the above SCPI command is the allocation index, not the slot position. See the “Add PUCCH Slot” on page 1037PUCCH Slot command for an explanation of the difference.</p> <p>Changes to this parameter will not be applied until Update Changes command is sent. See “RB Parameter Manager (Uplink)” on page 1073 section for more details.</p>

Dependencies:	<p>The range of sub op code <n> values is determined by the number of Users the user has configured. Max value for n=50. The range of sub op code <m> values is 0 – 19.</p> <p>If the user attempts to remotely set or query a sub op code that is out of range, this will result in an error message.</p> <p>Enabled when all the following conditions are met.</p> <p>Either Format Couple is ON and Common Format is not Type 2, Type 2a, Type 2b or Format Couple is OFF and Slot Format of the same slot is not Type 2, Type 2a, Type 2b.</p> <p>OS Couple is OFF.</p> <p>and PUCCH Active is ON</p>
Preset:	IND0
State Saved:	Saved in instrument state.
Range:	Index 0 Index 1 Index2
Initial S/W Revision:	Prior to A.02.00
Modified at S/W Revision:	A.03.00
Help Map ID:	29339

Index0

Selects Index0 for the OS for the selected PUCCH Slot.

Key Path:	Meas Setup, Chan Profile Setup, Edit User Mapping, PUCCH, OS
Mode:	LTE, LTETDD
Initial S/W Revision:	Prior to A.02.00
Modified at S/W Revision:	A.03.00
Help Map ID:	30792

Index1

Selects Index1 for the OS for the selected PUCCH Slot.

Key Path:	Meas Setup, Chan Profile Setup, Edit User Mapping, PUCCH, OS
Mode:	LTE, LTETDD
Initial S/W Revision:	Prior to A.02.00
Modified at S/W Revision:	A.03.00
Help Map ID:	30793

LTE Modulation Analysis Measurement
Meas Setup (Measurement Setup)

Index2

Selects Index2 for the OS for the selected PUCCH Slot.

Key Path:	Meas Setup, Chan Profile Setup, Edit User Mapping, PUCCH, OS
Mode:	LTE, LTETDD
Initial S/W Revision:	Prior to A.02.00
Modified at S/W Revision:	A.03.00
Help Map ID:	30794

Slot Power Boost

Sets the Power Boost value for the selected PUCCH Slot.

Key Path:	Meas Setup, Chan Profile Setup, Edit User Mapping, PUCCH, Power Boost
Mode:	LTE, LTETDD
Remote Command:	[:SENSE] :EVM:ULINK:PROFile:USER<n>:PUCCh:SLOT<m>:PWRBoo st <rel_amp1> [:SENSE] :EVM:ULINK:PROFile:USER<n>:PUCCh:SLOT<m>:PWRBoo st?
Example:	EVM:ULIN:PROF:USER1:PUCCh:SLOT0:PWRB 0 EVM:ULIN:PROF:USER1:PUCCh:SLOT0:PWRB?
Notes:	The index <m> in the above SCPI command is the allocation index, not the slot position. See the “Add PUCCH Slot” on page 1037 PUCCH Slot command for an explanation of the difference. Changes to this parameter will not be applied until Update Changes command is sent. See “RB Parameter Manager (Uplink)” on page 1073 section for more details.
Dependencies:	The range of sub op code <n> values is determined by the number of Users the user has configured. The range of sub op code <m> values is determined by the number of Slots the user has configured. . Max value for n=50. The range of sub op code <m> values is 0 – 19. If the user attempts to remotely set or query a sub op code that is out of range, this will result in an error message. Enabled when Power Boost Couple is OFF and PUCCH Active is ON.
Preset:	0 dB
State Saved:	Saved in instrument state.
Min:	-100 dB
Max:	100 dB
Initial S/W Revision:	Prior to A.02.00

Modified at S/W Revision:	A.03.00, A.04.20
Help Map ID:	29347

Slot DMRS Group

Selects the DMRS Group for the selected PUCCH Slot.

Key Path:	Meas Setup, Chan Profile Setup, Edit User Mapping, PUSCH,DMRS Group
Mode:	LTE, LTETDD
Remote Command:	[:SENSe] :EVM:ULINk:PROFile:USER<n>:PUCCh:SLOT<m>:DMRS:GROup <integer> [:SENSe] :EVM:ULINk:PROFile:USER<n>:PUCCh:SLOT<m>:DMRS:GROup?
Example:	EVM:ULIN:PROF:USER1:PUCCh:SLOT0:DMRS:GRO 1 EVM:ULIN:PROF:USER1:PUCCh:SLOT0:DMRS:GRO?
Notes:	The index <m> in the above SCPI command is the allocation index, not the slot position. See the “Add PUCCH Slot” on page 1037 PUCCH Slot command for an explanation of the difference. Changes to this parameter will not be applied until Update Changes command is sent. See “RB Parameter Manager (Uplink)” on page 1073 section for more details.
Dependencies:	The range of sub op code <n> values is determined by the number of Users the user has configured. The range of sub op code <m> values is determined by the number of Slots the user has configured. Max value for n=50. The range of sub op code <m> values is 0 – 19. If the user attempts to remotely set or query a sub op code that is out of range, this will result in an error message. Enabled when DMRS Params is OFF, DMRS Group Couple is OFF and PUCCH Active is ON.
Preset:	0
State Saved:	Saved in instrument state.
Min:	0
Max:	29
Initial S/W Revision:	Prior to A.02.00
Modified at S/W Revision:	A.03.00
Help Map ID:	29337

LTE Modulation Analysis Measurement
Meas Setup (Measurement Setup)

Slot DMRS Power Boost

Sets the DMRS Power Boost value for the selected PUCCH Slot.

Key Path:	Meas Setup, Chan Profile Setup, Edit User Mapping, PUCCH, DMRS Power Boost
Mode:	LTE, LTETDD
Remote Command:	[:SENSe] :EVM:ULINk:PROFile:USER<n>:PUCCh:SLOT<m>:DMRS:PW WRBoost <rel_ampl> [:SENSe] :EVM:ULINk:PROFile:USER<n>:PUCCh:SLOT<m>:DMRS:PW WRBoost?
Example:	EVM:ULIN:PROF:USER1:PUCCh:SLOT0:DMRS:PW 0 EVM:ULIN:PROF:USER1:PUCCh:SLOT0:DMRS:PW?
Notes:	The index <m> in the above SCPI command is the allocation index, not the slot position. See the “Add PUCCH Slot” on page 1037 PUCCH Slot command for an explanation of the difference. Changes to this parameter will not be applied until Update Changes command is sent. See “RB Parameter Manager (Uplink)” on page 1073 section for more details.
Dependencies:	The range of sub op code <n> values is determined by the number of Users the user has configured. The range of sub op code <m> values is determined by the number of Slots the user has configured. . Max value for n=50. The range of sub op code <m> values is 0 – 19. If the user attempts to remotely set or query a sub op code that is out of range, this will result in an error message. Enabled when Power Boost Couple is OFF and PUCCH Active is ON.
Preset:	0 dB
State Saved:	Saved in instrument state.
Min:	-100 dB
Max:	100 dB
Initial S/W Revision:	Prior to A.02.00
Modified at S/W Revision:	A.03.00, A.04.20
Help Map ID:	30795

Slot N PUCCH (1)

Sets the N PUCCH (1) value for the selected PUCCH Slot.

Key Path:	Meas Setup, Chan Profile Setup, Edit User Mapping, PUCCH
Mode:	LTE, LTETDD

Remote Command:	[:SENSe] :EVM:ULINk:PROFile:USER<n>:PUCCh:SLOT<m>:N:ONE <integer> [:SENSe] :EVM:ULINk:PROFile:USER<n>:PUCCh:SLOT<m>:N:ONE?
Example:	EVM:ULIN:PROF:USER1:PUCc:SLOT1:N:ONE 1 EVM:ULIN:PROF:USER1:PUCc:SLOT1:N:ONE?
Notes:	Changes to this parameter will not be applied until Update Changes command is sent. See RB Parameter Manager (Uplink) section for more details.
Dependencies:	The range of sub op code <n> values is determined by the number of Users the user has configured. The range of sub op code <m> values is determined by the number of Slots the user has configured. . Max value for n=50. The range of sub op code <m> values is 0 – 19. If the user attempts to remotely set or query a sub op code that is out of range, this will result in an error message. Enabled when Detection is Manual, PUCCH Active is ON, PUCCH DMRS Params is ON and N PUCCH (1) Couple is OFF.
Couplings:	$n_{PUCCH(1)}$ should be less than the total available subcarrier number of the current bandwidth selection.
Preset:	0
State Saved:	Saved in instrument state.
Min:	0
Max:	1199
Initial S/W Revision:	A.06.00
Help Map ID:	29248

Add PUCCH Slot

Adds a new PUCCH allocation pair. One of the allocations will be in the slot position specified, if available. The other will be in the slot immediately following if the parameter is even, or the slot immediately preceding if the parameter is odd. The new allocations will have their parameters set to default values. They are put into a collection of allocations in ascending order of slot position. The allocation at the even numbered slot gets the lower index. The SCPI commands that follow are used to set slot allocation parameters, such as RB. They all contain the mnemonic SLOT<m>, where <m> is an index into the collection of allocations. The index ranges from 0 to a maximum of 19. Do not confuse the allocation index with the slot position.

To avoid confusion, you should make PUCCH allocations in ascending order of even slot positions.

For example, suppose you sent the following commands in order (and no previous allocations were made):

EVM:ULIN:PROF:USER1:PUCc:ADD:SLOT 0

EVM:ULIN:PROF:USER1:PUCc:ADD:SLOT 8

EVM:ULIN:PROF:USER1:PUCc:ADD:SLOT 10

You now have six allocations. Allocation 0 is at slot position 0, allocation 1 is made automatically at slot position 1, allocations 2 and 3 are at slot positions 8 and 9, and allocations 4 and 5 at slot positions 10 and 11. The allocations are referenced as SLOT0, SLOT1, SLOT2, etc. in the commands that follow. For example, if you want to verify the

LTE Modulation Analysis Measurement
Meas Setup (Measurement Setup)

slot position of the third allocation, send the following query:

EVM:ULIN:PROF:USER1:PUCCH:SLOT2:POS?

This will return 8 for this example, and the following query will return “9”s:

EVM:ULIN:PROF:USER1:PUCCH:SLOT3:POS?

Note that if you delete an allocation, its paired companion is deleted also. It is recommended that you only delete even indices. To continue the previous example, send the following command:

EVM:ULIN:PROF:USER1:PUCCH:SLOT2:DEL

This removes the allocations at slot positions 8 and 9. The allocations at slot positions 10 and 11 are now referenced as SLOT2 and SLOT3, where before they were referenced as SLOT4 and SLOT5.

Key Path:	Meas Setup, Chan Profile Setup, Edit User Mapping, PUCCH, Slot
Mode:	LTE, LTETDD
Remote Command:	[:SENSE] :EVM:ULINK:PROF:USER<n>:PUCCH:ADD:SLOT<integer>
Example:	EVM:ULIN:PROF:USER1:PUCCH:ADD:SLOT 0
Notes:	The softkey for this parameter is an Immediate Action key. The value that is passed in by the SCPI command enables you to specify the slot position. As PUCCH has subframes, adding a slot will add the slot specified, if available, and the second slot in the subframe.
Notes:	Changes to this parameter will not be applied until Update Changes command is sent. See “RB Parameter Manager (Uplink)” on page 1073 section for more details.
Dependencies:	The range of sub op code <n> values is determined by the number of Users the user has configured. If the user attempts to add a Slot to a User and the slot is already allocated an error message will be generated. Disabled once the number of Slots reaches to 20 (max).
Preset:	0
State Saved:	Saved in instrument state.
Min:	0
Max:	19
Initial S/W Revision:	Prior to A.02.00
Modified at S/W Revision:	A.03.00
Help Map ID:	29333

Delete PUCCH Slot

Deletes the currently selected slot allocation and its paired slot allocation.

Key Path:	Meas Setup, Chan Profile Setup, Edit User Mapping, PUCCH, Slot
-----------	---

Mode:	LTE, LTETDD
Remote Command:	[:SENSe] :EVM:ULINk:PROFile:USER<n>:PUCCh:SLOT<m>:DELeTe
Example:	EVM:ULIN:PROF:USER1:PUCc:SLOT0:DEL
Notes:	<p>The index <m> in the above SCPI command is the allocation index, not the slot position. See the “Add PUCCH Slot” on page 1037 PUCCH Slot command for an explanation of the difference.</p> <p>Changes to this parameter will not be applied until Update Changes command is sent. See “RB Parameter Manager (Uplink)” on page 1073 section for more details.</p>
Dependencies:	<p>Disabled when there is only one Slot.</p> <p>The range of sub op code <n> values is determined by the number of Users the user has configured. The range of sub op code <m> values is determined by the number of Slots the user has configured. . Max value for n=50. The range of sub op code <m> values is 0 – 19.</p> <p>If the user attempts to delete a Slot that does not exist, an error message will be generated.</p>
Initial S/W Revision:	Prior to A.02.00
Modified at S/W Revision:	A.03.00
Help Map ID:	29334

Move Up

Moves the currently selected Slot up.

See also [“Slot Position ” on page 1040](#) query

Key Path:	Meas Setup, Chan Profile Setup, Edit User Mapping, PUCCH, Slot
Mode:	LTE, LTETDD
Dependencies:	Disabled when there are no Slots defined or if the slot is at Slot19.
Initial S/W Revision:	Prior to A.02.00
Modified at S/W Revision:	A.03.00
Help Map ID:	30790

Move Down

Moves the currently selected Slot down.

See also [“Slot Position ” on page 1040](#) query.

Key Path:	Meas Setup, Chan Profile Setup, Edit User Mapping, PUCCH, Slot
Mode:	LTE, LTETDD
Dependencies:	Disabled when there are no Slots defined or if the slot is at Slot0.

LTE Modulation Analysis Measurement
Meas Setup (Measurement Setup)

Initial S/W Revision:	Prior to A.02.00
Modified at S/W Revision:	A.03.00
Help Map ID:	30789

Slot Position

Queries the PUCCH slot start position.

Key Path:	SCPI Only
Mode:	LTE, LTETDD
Remote Command:	[:SENSe] :EVM:ULINK:PROFile:USER<n>:PUCCh:SLOT<m>:POSiti on?
Example:	EVM:ULIN:PROF:USER1:PUCCh:SLOT0:POS?
Dependencies:	The range of sub op code <n> values is determined by the number of Users the user has configured. The range of sub op code <m> values is determined by the number of Slots the user has configured. . Max value for n=50. The range of sub op code <m> values is 0 – 19.
Preset:	0
State Saved:	Saved in instrument state.
Min:	0
Max:	19
Initial S/W Revision:	Prior to A.02.00
Modified at S/W Revision:	A.03.00
Help Map ID:	0

PRACH Parameters

Displays a menu that enables you to set PRACH channel parameters for signals.

Key Path:	Meas Setup, Chan Profile Setup, Edit User Mapping, PRACH Parameters
Mode:	LTE, LTETDD
Initial S/W Revision:	Prior to A.02.00
Modified at S/W Revision:	A.03.00
Help Map ID:	29111

PRACH Active

Selects whether or not PRACH exists in the input signal when Detection is Manual.

Key Path:	Meas Setup, Chan Profile Setup, Edit User Mapping
-----------	--

Mode:	LTE, LTETDD
Remote Command:	[:SENSe] :EVM:ULINk:PROFile:USER1 50:PRACH:ACTive OFF ON 0 1 [:SENSe] :EVM:ULINk:PROFile:USER1 50:PRACH:ACTive?
Example:	EVM:ULIN:PROF:USER1:PRAC:ACT OFF EVM:ULIN:PROF:USER1:PRAC:ACT?
Notes:	Changes to this parameter will not be applied until Update Changes command is sent. See “RB Parameter Manager (Uplink)” on page 1073 section for more details.
Dependencies:	Enabled when Detection is Manual. When this parameter is set to OFF, all of soft keys for PRACH parameter are grayed out.
Preset:	OFF
State Saved:	Saved in instrument state.
Initial S/W Revision:	A.03.00
Help Map ID:	40826

Auto Detect PRACH Active

Selects whether or not PRACH exists in the input signal when Detection is Auto.

Key Path:	Meas Setup, Chan Profile Setup, Edit User Mapping
Mode:	LTE, LTETDD
Remote Command:	[:SENSe] :EVM:ULINk:PROFile:AUTO:PRACH:ACTive OFF ON 0 1 [:SENSe] :EVM:ULINk:PROFile:AUTO:PRACH:ACTive?
Example:	EVM:ULIN:PROF:AUTO:PRAC:ACT OFF EVM:ULIN:PROF:AUTO:PRAC:ACT?
Notes:	Changes to this parameter will not be applied until Update Changes command is sent. See “RB Parameter Manager (Uplink)” on page 1073 section for more details.
Dependencies:	Enabled when Detection is Auto.
Preset:	OFF
State Saved:	Saved in instrument state.
Initial S/W Revision:	A.03.00
Help Map ID:	0

LTE Modulation Analysis Measurement
Meas Setup (Measurement Setup)

Resource Block Offset (nRAPRB)

Sets the number of Resource Block that PRACH is offset from 0 in the frequency domain (n_{PRB}^{RA}) when Detection is Manual. (3GPP TS 36.211 V8.5.0 5.7)

For PRACH preamble formats 0–3, this parameter is used to calculate the start location in frequency for the PRACH preamble. This parameter does not affect the start location of format 4 preamble.

Key Path:	Meas Setup, Chan Profile Setup, Edit User Mapping, PRACH Setup
Mode:	LTE, LTETDD
Remote Command:	[:SENSE] :EVM:ULINK:PROF:USER<n>:PRACH:NRAPrb <integer> [:SENSE] :EVM:ULINK:PROF:USER<n>:PRACH:NRAPrb?
Example:	EVM:ULIN:PROF:USER1:PRACH:NRAP 1 EVM:ULIN:PROF:USER1:PRACH:NRAP?
Notes:	Changes to this parameter will not be applied until Update Changes command is sent. See “RB Parameter Manager (Uplink)” on page 1073 section for more details.
Dependencies:	The range of sub op code <n> values is determined by the number of Users the user has configured. If the user attempts to remotely set or query a sub op code that is out of range, this will result in an error message. The maximum value is [number of resource blocks in a slot] – 6. Enabled when Detection is Manual and PRACH Active is ON.
Preset:	0
State Saved:	Saved in instrument state.
Min:	0
Max:	94 - The maximum value is [number of resource blocks in a slot] – 6. [number of resource blocks in a slot] is determined by Bandwidth setting. 0 – Bandwidth 1.4 MHz 9 - Bandwidth 3 MHz 19 - Bandwidth 5 MHz 44 - Bandwidth 10 MHz 69 - Bandwidth 15 MHz 94 - Bandwidth 20 MHz
Initial S/W Revision:	A.03.00
Help Map ID:	40827

Auto Detect Resource Block Offset (nRAPRB)

Sets the number of Resource Block that PRACH is offset from 0 in the frequency domain (n_{PRB}^{RA}) when Detection is Auto. (3GPP TS 36.211 V8.5.0 5.7)

Key Path:	Meas Setup, Chan Profile Setup, Edit User Mapping, PRACH Setup
Mode:	LTE, LTETDD
Remote Command:	[:SENSe] :EVM:ULINk:PROFile:AUTO:PRACH:NRAPrb <integer> [:SENSe] :EVM:ULINk:PROFile:AUTO:PRACH:NRAPrb?
Example:	EVM:ULIN:PROF:AUTO:PRACH:NRAP 1 EVM:ULIN:PROF:AUTO:PRACH:NRAP?
Notes:	Changes to this parameter will not be applied until Update Changes command is sent. See “ RB Parameter Manager (Uplink) ” on page 1073 section for more details.
Dependencies:	Enabled when Detection is Auto and Auto Detect PRACH Active is ON.
Preset:	0
State Saved:	Saved in instrument state.
Min:	0
Max:	94 - The maximum value is [number of resource blocks in a slot] – 6. [number of resource blocks in a slot] is determined by Bandwidth setting. 0 – Bandwidth 1.4 MHz 9 - Bandwidth 3 MHz 19 - Bandwidth 5 MHz 44 - Bandwidth 10 MHz 69 - Bandwidth 15 MHz 94 - Bandwidth 20 MHz
Initial S/W Revision:	A.03.00
Help Map ID:	0

Configuration Index

Sets PRACH Configuration Index to give frame structure when Detection is Manual. (3GPP TS 36.211 V8.5.0 5.7)

This parameter determines the PRACH preamble format and the locations where PRACH can be transmitted in the frame.

This information is given in table 5.7.1–2 for frame type 1 FDD signals and in table 5.7.1–3 for frame type 2 TDD signals in 3GPP TS 36.211.

Key Path:	Meas Setup, Chan Profile Setup, Edit User Mapping, PRACH Setup
-----------	---

LTE Modulation Analysis Measurement
Meas Setup (Measurement Setup)

Mode:	LTE, LTETDD
Remote Command:	[:SENSe] :EVM:ULINK:PROFile:USER<n>:PRACH:CINDeX <integer> [:SENSe] :EVM:ULINK:PROFile:USER<n>:PRACH:CINDeX?
Example:	EVM:ULIN:PROF:USER1:PRACH:CIND 1 EVM:ULIN:PROF:USER1:PRACH:CIND?
Notes:	Changes to this parameter will not be applied until Update Changes command is sent. See “RB Parameter Manager (Uplink)” on page 1073 section for more details.
Dependencies:	The range of sub op code <n> values is determined by the number of Users the user has configured. If the user attempts to remotely set or query a sub op code that is out of range, this will result in an error message. Enabled when Detection is Manual and PRACH Active is ON.
Preset:	0
State Saved:	Saved in instrument state.
Min:	0
Max:	LTE: 63 LTETDD: 57
Initial S/W Revision:	A.03.00
Help Map ID:	40828

Auto Detect Configuration Index

Sets the PRACH Configuration Index to give frame structure when Detection is Auto. (3GPP TS 36.211 V8.5.0 5.7)

Key Path:	Meas Setup, Chan Profile Setup, Edit User Mapping, PRACH Setup
Mode:	LTE, LTETDD
Remote Command:	[:SENSe] :EVM:ULINK:PROFile:AUTO:PRACH:CINDeX <integer> [:SENSe] :EVM:ULINK:PROFile:AUTO:PRACH:CINDeX?
Example:	EVM:ULIN:PROF:AUTO:PRACH:CIND 1 EVM:ULIN:PROF:AUTO:PRACH:CIND?
Notes:	Changes to this parameter will not be applied until Update Changes command is sent. See “RB Parameter Manager (Uplink)” on page 1073 section for more details.
Dependencies:	Enabled when Detection is Auto and Auto Detect PRACH Active is ON.
Preset:	0

State Saved:	Saved in instrument state.
Min:	0
Max:	LTE: 63 LTETDD: 57
Initial S/W Revision:	A.03.00
Help Map ID:	0

Logical Root Seq Index

Sets the Logical Root Seq Index to give root Zadoff-Chu sequence order when Detection is Manual. (3GPP TS 36.211 V8.5.0 5.7)

For preamble formats 0–3, there are 838 total logical indexes. For preamble format 4, there are 138 logical indexes.

The mapping between logical and physical Zadoff-Chu indexes is given in Table 5.7.2–4 for preamble formats 0–3 and in Table 5.7.2–5 for preamble format 4 in TS 36.211.

Key Path:	Meas Setup, Chan Profile Setup, Edit User Mapping, PRACH Setup
Mode:	LTE, LTETDD
Remote Command:	[:SENSE] :EVM:ULINK:PROfile:USER<n>:PRACH:LRSindex <integer> [:SENSE] :EVM:ULINK:PROfile:USER<n>:PRACH:LRSindex?
Example:	EVM:ULIN:PROF:USER1:PRACH:LRS 1 EVM:ULIN:PROF:USER1:PRACH:LRS?
Notes:	Changes to this parameter will not be applied until Update Changes command is sent. See “RB Parameter Manager (Uplink)” on page 1073 section for more details.
Dependencies:	The range of sub op code <n> values is determined by the number of Users the user has configured. If the user attempts to remotely set or query a sub op code that is out of range, this will result in an error message. Enabled when Detection is Manual and PRACH Active is ON.
Preset:	0
State Saved:	Saved in instrument state.
Min:	0
Max:	837
Initial S/W Revision:	A.03.00
Help Map ID:	40829

LTE Modulation Analysis Measurement
Meas Setup (Measurement Setup)

Auto Detect Logical Root Seq Index

Sets Logical Root Seq Index to give root Zadoff-Chu sequence order when Detection is Auto. (3GPP TS 36.211 V8.5.0 5.7)

Key Path:	Meas Setup, Chan Profile Setup, Edit User Mapping, PRACH Setup
Mode:	LTE, LTETDD
Remote Command:	[:SENSe] :EVM:ULINK:PROFile:AUTO:PRACH:LRSindex <integer> [:SENSe] :EVM:ULINK:PROFile:AUTO:PRACH:LRSindex?
Example:	EVM:ULIN:PROF:AUTO:PRACH:LRS 1 EVM:ULIN:PROF:AUTO:PRACH:LRS?
Notes:	Changes to this parameter will not be applied until Update Changes command is sent. See “RB Parameter Manager (Uplink)” on page 1073 section for more details.
Dependencies:	Enabled when Detection is Auto and Auto Detect PRACH Active is ON.
Preset:	0
State Saved:	Saved in instrument state.
Min:	0
Max:	837
Initial S/W Revision:	A.03.00
Help Map ID:	0

Cyclic Shift Set

Sets Cyclic Shift Set to give N_{CS} (Number of Cyclic Shifts) for PRACH preamble sequence generation when Detection is Manual. Value of N_{CS} will be determined by this selection and value of N_{CS} Configuration. (3GPP TS 36.211 V8.5.0 Table 5.7.2–2)

Key Path:	Meas Setup, Chan Profile Setup, Edit User Mapping, PRACH Setup
Mode:	LTE, LTETDD
Remote Command:	[:SENSe] :EVM:ULINK:PROFile:USER<n>:PRACH:CSSet UNRestricted RESTRicted [:SENSe] :EVM:ULINK:PROFile:USER<n>:PRACH:CSSet?
Example:	EVM:ULIN:PROF:USER1:PRAC:CSS UNR EVM:ULIN:PROF:USER1:PRAC:CSS?
Notes:	Changes to this parameter will not be applied until Update Changes command is sent. See “RB Parameter Manager (Uplink)” on page 1073 section for more details.

Dependencies:	The range of sub op code <n> values is determined by the number of Users the user has configured. Enabled when Detection is Manual and PRACH Active is ON.
Preset:	UNRestricted
State Saved:	Saved in instrument state.
Range:	Unrestricted Restricted
Initial S/W Revision:	A.03.00
Help Map ID:	40830

Auto Detect Cyclic Shift Set

Sets Cyclic Shift Set to give N_{CS} (Number of Cyclic Shifts) for PRACH preamble sequence generation when Detection is Auto. Value of N_{CS} will be determined by this selection and value of N_{CS} Configuration. (3GPP TS 36.211 V8.5.0 Table 5.7.2–3)

Key Path:	Meas Setup, Chan Profile Setup, Edit User Mapping, PRACH Setup
Mode:	LTE, LTETDD
Remote Command:	[:SENSe] :EVM:ULINK:PROFile:AUTO:PRACH:CSSet UNRestricted RESTRicted [:SENSe] :EVM:ULINK:PROFile:AUTO:PRACH:CSSet?
Example:	EVM:ULIN:PROF:AUTO:PRAC:CSS UNR EVM:ULIN:PROF:AUTO:PRAC:CSS?
Notes:	Changes to this parameter will not be applied until Update Changes command is sent. See “RB Parameter Manager (Uplink)” on page 1073 section for more details.
Dependencies:	Enabled when Detection is Auto and Auto Detect PRACH Active is ON.
Preset:	UNRestricted
State Saved:	Saved in instrument state.
Range:	Unrestricted Restricted
Initial S/W Revision:	A.03.00
Help Map ID:	0

NCS Configuration

Sets the Cyclic Shift Configuration Number to give N_{CS} (Number of Cyclic Shifts) PRACH preamble sequence generation when Detection is Manual. Value of N_{CS} will be determined by this value and selection of Cyclic Shift Set. (3GPP TS 36.211 V8.5.0 Table 5.7.2–2,3)

Key Path:	Meas Setup, Chan Profile Setup, Edit User Mapping, PRACH Setup
-----------	---

LTE Modulation Analysis Measurement
Meas Setup (Measurement Setup)

Mode:	LTE, LTETDD
Remote Command:	[:SENSe] :EVM:ULINK:PROFile:USER<n>:PRACH:NCSCConfig <integer> [:SENSe] :EVM:ULINK:PROFile:USER<n>:PRACH:NCSCConfig?
Example:	EVM:ULIN:PROF:USER1:PRACH:NCSC 1 EVM:ULIN:PROF:USER1:PRACH:NCSC?
Notes:	Changes to this parameter will not be applied until Update Changes command is sent. See “RB Parameter Manager (Uplink)” on page 1073 section for more details.
Dependencies:	The range of sub op code <n> values is determined by the number of Users the user has configured. If the user attempts to remotely set or query a sub op code that is out of range, this will result in an error message. Enabled when Detection is Manual and PRACH Active is ON.
Preset:	0
State Saved:	Saved in instrument state.
Min:	0
Max:	15
Initial S/W Revision:	A.03.00
Help Map ID:	40831

Auto Detect NCS Configuration

Sets the Cyclic Shift Configuration Number to give N_{CS} (Number of Cyclic Shifts) PRACH preamble sequence generation when Detection is Auto. Value of N_{CS} will be determined by this value and selection of Cyclic Shift Set. (3GPP TS 36.211 V8.5.0 Table 5.7.2–3)

Key Path:	Meas Setup, Chan Profile Setup, Edit User Mapping, PRACH Setup
Mode:	LTE, LTETDD
Remote Command:	[:SENSe] :EVM:ULINK:PROFile:AUTO:PRACH:NCSCConfig <integer> [:SENSe] :EVM:ULINK:PROFile:AUTO:PRACH:NCSCConfig?
Example:	EVM:ULIN:PROF:AUTO:PRACH:NCSC 1 EVM:ULIN:PROF:AUTO:PRACH:NCSC?
Notes:	Changes to this parameter will not be applied until Update Changes command is sent. See “RB Parameter Manager (Uplink)” on page 1073 section for more details.
Dependencies:	Enabled when Detection is Auto and Auto Detect PRACH Active is ON.

Preset:	0
State Saved:	Saved in instrument state.
Min:	0
Max:	15
Initial S/W Revision:	A.03.00
Help Map ID:	0

Preamble Index

Sets the Preamble Index when Detection is Manual. Preamble sequence generation is presented on 3GPP TS 36.211 V8.5.0 – 5.7.2.

Key Path:	Meas Setup, Chan Profile Setup, Edit User Mapping, PRACH Setup
Mode:	LTE, LTETDD
Remote Command:	[:SENSE] :EVM:ULINK:PROfile:USER<n>:PRACH:PINDEX <integer> [:SENSE] :EVM:ULINK:PROfile:USER<n>:PRACH:PINDEX?
Example:	EVM:ULIN:PROF:USER1:PRACH:PIND 1 EVM:ULIN:PROF:USER1:PRACH:PIND?
Notes:	Changes to this parameter will not be applied until Update Changes command is sent. See “RB Parameter Manager (Uplink)” on page 1073 section for more details.
Dependencies:	The range of sub op code <n> values is determined by the number of Users the user has configured. If the user attempts to remotely set or query a sub op code that is out of range, this will result in an error message. Enabled when Detection is Manual and PRACH Active is ON.
Preset:	0
State Saved:	Saved in instrument state.
Min:	0
Max:	63
Initial S/W Revision:	A.03.00
Help Map ID:	40832

Auto Detect Preamble Index

Sets the Preamble Index when Detection is Auto. Preamble sequence generation is presented on 3GPP TS 36.211

LTE Modulation Analysis Measurement
Meas Setup (Measurement Setup)

V8.5.0 – 5.7.2.

Key Path:	Meas Setup, Chan Profile Setup, Edit User Mapping, PRACH Setup
Mode:	LTE, LTETDD
Remote Command:	[:SENSe] :EVM:ULINk:PROFile:AUTO:PRACH:PINDeX <integer> [:SENSe] :EVM:ULINk:PROFile:AUTO:PRACH:PINDeX?
Example:	EVM:ULIN:PROF:AUTO:PRAC:PINd 1 EVM:ULIN:PROF:AUTO:PRAC:PINd?
Notes:	Changes to this parameter will not be applied until Update Changes command is sent. See “ RB Parameter Manager (Uplink) ” on page 1073 section for more details.
Dependencies:	Enabled when Detection is Auto and Auto Detect PRACH Active is ON.
Preset:	0
State Saved:	Saved in instrument state.
Min:	0
Max:	63
Initial S/W Revision:	A.03.00
Help Map ID:	0

PRACH Power Boost

Sets the PRACH Power Boost value when Detection is Manual.

This parameter specifies the average power of PRACH subcarriers.

Key Path:	Meas Setup, Chan Profile Setup, Edit User Mapping, PRACH Setup
Mode:	LTE, LTETDD
Remote Command:	[:SENSe] :EVM:ULINk:PROFile:USER<n>:PRACH:PWRBoost <rel_ampl> [:SENSe] :EVM:ULINk:PROFile:USER<n>:PRACH:PWRBoost?
Example:	EVM:ULIN:PROF:USER1:PRAC:PWRB 1 EVM:ULIN:PROF:USER1:PRAC:PWRB?
Notes:	Changes to this parameter will not be applied until Update Changes command is sent. See “ RB Parameter Manager (Uplink) ” on page 1073 section for more details.

Dependencies:	The range of sub op code <n> values is determined by the number of Users the user has configured. If the user attempts to remotely set or query a sub op code that is out of range, this will result in an error message. Enabled when Detection is Manual and PRACH Active is ON.
Preset:	0
State Saved:	Saved in instrument state.
Min:	-100
Max:	100
Initial S/W Revision:	A.03.00
Modified at S/W Revision:	A.04.20
Help Map ID:	40833

Auto Detect PRACH Power Boost

Sets the PRACH Power Boost value when Detection is Auto.

Key Path:	Meas Setup, Chan Profile Setup, Edit User Mapping, PRACH Setup
Mode:	LTE, LTETDD
Remote Command:	[:SENSE] :EVM:ULINK:PROfile:AUTO:PRACH:PWRBoost <rel_ampl> [:SENSE] :EVM:ULINK:PROfile:AUTO:PRACH:PWRBoost?
Example:	EVM:ULIN:PROF:AUTO:PRACH:PWRB 1 EVM:ULIN:PROF:AUTO:PRACH:PWRB?
Notes:	Changes to this parameter will not be applied until Update Changes command is sent. See “RB Parameter Manager (Uplink)” on page 1073 section for more details.
Dependencies:	Enabled when Detection is Auto and Auto Detect PRACH Active is ON.
Preset:	0
State Saved:	Saved in instrument state.
Min:	-100
Max:	100
Initial S/W Revision:	A.03.00
Modified at S/W Revision:	A.04.20
Help Map ID:	0

LTE Modulation Analysis Measurement
Meas Setup (Measurement Setup)

Sync Resource

Sets the index value for random access resource, which is used as a synchronization reference when Detection is Manual. Random access preamble mapping is presented on 3GPP TS 36.211 V8.5.0 5.7 Table 5.7.1–4.

Key Path:	Meas Setup, Chan Profile Setup, Edit User Mapping, PRACH Setup
Mode:	LTETDD
Remote Command:	[:SENSe] :EVM:ULINk:PROFile:USER<n>:PRACH:SRESsource <integer> [:SENSe] :EVM:ULINk:PROFile:USER<n>:PRACH:SRESsource?
Example:	EVM:ULIN:PROF:USER1:PRAC:SRES 0 EVM:ULIN:PROF:USER1:PRAC:SRES?
Notes:	Max value of this parameter depends on Configuration Index and UL/DL Configuration. Disabled when the combination of Configuration Index and UL/DL Configuration results in the N/A in 3GPP TS 36.211 V8.5.0 5.7 Table 5.7.1–4.
Notes:	Changes to this parameter will not be applied until Update Changes command is sent. See “RB Parameter Manager (Uplink)” on page 1073 section for more details.
Dependencies:	The range of sub op code <n> values is determined by the number of Users the user has configured. If the user attempts to remotely set or query a sub op code that is out of range, this will result in an error message. Enabled when the mode is LTE TDD, Detection is Manual, and PRACH Active is ON.
Preset:	0
State Saved:	Saved in instrument state.
Min:	0
Max:	5
Initial S/W Revision:	A.03.00
Help Map ID:	40834

Auto Detect Sync Resource

Sets the index value for random access resource, which is used as synchronization reference when Detection is Auto. Random access preamble mapping is presented on 3GPP TS 36.211 V8.5.0 5.7 Table 5.7.1–4.

Key Path:	Meas Setup, Chan Profile Setup, Edit User Mapping, PRACH Setup
Mode:	LTETDD

Remote Command:	[:SENSe] :EVM:ULINk:PROFile:AUTO:PRACH:SRESorce <integer> [:SENSe] :EVM:ULINk:PROFile:AUTO:PRACH:SRESorce?
Example:	EVM:ULIN:PROF:AUTO:PRACH:SRES 0 EVM:ULIN:PROF:AUTO:PRACH:SRES?
Notes:	Max value of this parameter depends on Configuration Index and UL/DL Configuration. This parameter is disabled when the combination of Configuration Index and UL/DL Configuration results in the N/A in 3GPP TS 36.211 V8.5.0 5.7 Table5.7.1–4. Changes to this parameter will not be applied until Update Changes command is sent. See “RB Parameter Manager (Uplink)” on page 1073 section for more details.
Dependencies:	Enabled when the mode is LTE TDD, Detection is Auto and Auto Detect PRACH Active is ON.
Preset:	0
State Saved:	Saved in instrument state.
Min:	0
Max:	5
Initial S/W Revision:	A.03.00
Help Map ID:	0

S-RS Parameters

Displays a menu that enables you to set S-RS channel parameters for signals.

Key Path:	Meas Setup, Chan Profile Setup, Edit User Mapping, S-RS Parameters
Mode:	LTE, LTETDD
Initial S/W Revision:	Prior to A.02.00
Modified at S/W Revision:	A.03.00
Help Map ID:	29117

S-RS Active

Selects whether or not S-RS exists in the input signal when Detection is Manual.

Key Path:	Meas Setup, Chan Profile Setup, Edit User Mapping
Mode:	LTE, LTETDD
Remote Command:	[:SENSe] :EVM:ULINk:PROFile:USER1 50:SRS:ACTive OFF ON 0 1 [:SENSe] :EVM:ULINk:PROFile:USER1 50:SRS:ACTive?

LTE Modulation Analysis Measurement
Meas Setup (Measurement Setup)

Example:	EVM:ULIN:PROF:USER1:SRS:ACT OFF EVM:ULIN:PROF:USER1:SRS:ACT?
Notes:	Changes to this parameter will not be applied until Update Changes command is sent. See “RB Parameter Manager (Uplink)” on page 1073 section for more details.
Dependencies:	Enabled when Detection is Manual. When this parameter is set to OFF, all of soft keys for S-RS parameter are grayed out.
Preset:	OFF
State Saved:	Saved in instrument state.
Initial S/W Revision:	A.03.00
Help Map ID:	40835

Auto Detect S-RS Active

Selects whether or not S-RS exists in the input signal when Detection is Auto.

Key Path:	Meas Setup, Chan Profile Setup, Edit User Mapping
Mode:	LTE, LTETDD
Remote Command:	[:SENSe] :EVM:ULINk:PROFile:AUTO:SRS:ACTive OFF ON 0 1 [:SENSe] :EVM:ULINk:PROFile:AUTO:SRS:ACTive?
Example:	EVM:ULIN:PROF:AUTO:SRS:ACT OFF EVM:ULIN:PROF:AUTO:SRS:ACT?
Notes:	Changes to this parameter will not be applied until Update Changes command is sent. See “RB Parameter Manager (Uplink)” on page 1073 section for more details.
Dependencies:	Enabled when Detection is Auto.
Preset:	OFF
State Saved:	Saved in instrument state.
Initial S/W Revision:	A.03.00
Help Map ID:	0

Cyclic Shift (nSRSCS)

Sets S-RS Cyclic Shift when Detection is Manual. This value determines the cyclic shift of R-RS.

Key Path:	Meas Setup, Chan Profile Setup, Edit User Mapping, SRS Setup
Mode:	LTE, LTETDD

Remote Command:	[:SENSE] :EVM:ULINK:PROFile:USER<n>:SRS:CSHift <integer> [:SENSE] :EVM:ULINK:PROFile:USER<n>:SRS:CSHift?
Example:	EVM:ULIN:PROF:USER1:SRS:CSH 1 EVM:ULIN:PROF:USER1:SRS:CSH?
Notes:	Changes to this parameter will not be applied until Update Changes command is sent. See “RB Parameter Manager (Uplink)” on page 1073 section for more details.
Dependencies:	The range of sub op code <n> values is determined by the number of Users the user has configured. If the user attempts to remotely set or query a sub op code that is out of range, this will result in an error message. Enabled when Detection is Manual and S-RS Active is ON.
Preset:	0
State Saved:	Saved in instrument state.
Min:	0
Max:	7
Initial S/W Revision:	A.03.00
Help Map ID:	40836

Auto Detect Cyclic Shift

Sets S-RS Cyclic Shift when Detection is Auto.

Key Path:	Meas Setup, Chan Profile Setup, Edit User Mapping, SRS Setup
Mode:	LTE, LTETDD
Remote Command:	[:SENSE] :EVM:ULINK:PROFile:AUTO:SRS:CSHift <integer> [:SENSE] :EVM:ULINK:PROFile:AUTO:SRS:CSHift?
Example:	EVM:ULIN:PROF:AUTO:SRS:CSH 1 EVM:ULIN:PROF:AUTO:SRS:CSH?
Notes:	Changes to this parameter will not be applied until Update Changes command is sent. See “RB Parameter Manager (Uplink)” on page 1073 section for more details.
Dependencies:	Enabled when Detection is Auto and Auto Detect S-RS Active is ON
Preset:	0
State Saved:	Saved in instrument state.
Min:	0
Max:	7

LTE Modulation Analysis Measurement
Meas Setup (Measurement Setup)

Initial S/W Revision:	A.03.00
Help Map ID:	0

Bandwidth Configuration (CSRS)

Sets S-RS Bandwidth Configuration (C_{SRS}) when Detection is Manual.

This parameter, along with B_{SRS} , determines the values of $m_{SRS,b}$ and N_b from tables 5.5.3.2–1 through 5.5.3.2–4 in TS 36.211.

Key Path:	Meas Setup, Chan Profile Setup, Edit User Mapping, SRS Setup
Mode:	LTE, LTETDD
Remote Command:	[:SENSE] :EVM:ULINK:PROFile:USER<n>:SRS:BConfig <integer> [:SENSe] :EVM:ULINK:PROFile:USER<n>:SRS:BConfig?
Example:	EVM:ULIN:PROF:USER1:SRS:BCON 1 EVM:ULIN:PROF:USER1:SRS:BCON?
Notes:	Changes to this parameter will not be applied until Update Changes command is sent. See “ RB Parameter Manager (Uplink) ” on page 1073 section for more details.
Dependencies:	The range of sub op code <n> values is determined by the number of Users the user has configured. If the user attempts to remotely set or query a sub op code that is out of range, this will result in an error message. Enabled when Detection is Manual and S-RS Active is ON.
Preset:	7
State Saved:	Saved in instrument state.
Min:	0
Max:	7
Initial S/W Revision:	A.03.00
Help Map ID:	40837

Auto Detect Bandwidth Configuration (CSRS)

Sets S-RS Bandwidth Configuration (C_{SRS}) when Detection is Auto.

Key Path:	Meas Setup, Chan Profile Setup, Edit User Mapping, SRS Setup
Mode:	LTE, LTETDD
Remote Command:	[:SENSE] :EVM:ULINK:PROFile:AUTO:SRS:BConfig <integer> [:SENSe] :EVM:ULINK:PROFile:AUTO:SRS:BConfig?

Example:	EVM:ULIN:PROF:AUTO:SRS:BCON 1 EVM:ULIN:PROF:AUTO:SRS:BCON?
Notes:	Changes to this parameter will not be applied until Update Changes command is sent. See “RB Parameter Manager (Uplink)” on page 1073 section for more details.
Dependencies:	Enabled when Detection is Auto and Auto Detect S-RS Active is ON
Preset:	7
State Saved:	Saved in instrument state.
Min:	0
Max:	7
Initial S/W Revision:	A.03.00
Help Map ID:	0

Bandwidth (BSRS)

Sets S-RS Bandwidth (B_{SRS}) when Detection is Manual. This parameter, along with C_{SRS} , determines the values of $m_{SRS,b}$ and N_b from tables 5.5.3.2–1 through 5.5.3.2–4 in TS 36.211.

Key Path:	Meas Setup, Chan Profile Setup, Edit User Mapping, SRS Setup
Mode:	LTE, LTETDD
Remote Command:	[:SENSE] :EVM:ULINK:PROFile:USER<n>:SRS:BWIDth <integer> [:SENSE] :EVM:ULINK:PROFile:USER<n>:SRS:BWIDth?
Example:	EVM:ULIN:PROF:USER1:SRS:BWID 1 EVM:ULIN:PROF:USER1:SRS:BWID?
Notes:	Changes to this parameter will not be applied until Update Changes command is sent. See “RB Parameter Manager (Uplink)” on page 1073 section for more details.
Dependencies:	The range of sub op code <n> values is determined by the number of Users the user has configured. If the user attempts to remotely set or query a sub op code that is out of range, this will result in an error message. Enabled when Detection is Manual, and S-RS Active is ON.
Preset:	0
State Saved:	Saved in instrument state.
Min:	0
Max:	3
Initial S/W Revision:	A.03.00

Help Map ID:	40838
--------------	-------

Auto Detect Bandwidth (BSRS)

Sets S-RS Bandwidth (B_{SRS}) when Detection is Auto.

Key Path:	Meas Setup, Chan Profile Setup, Edit User Mapping, SRS Setup
Mode:	LTE, LTETDD
Remote Command:	[:SENSe] :EVM:ULINk:PROFile:AUTO:SRS:BWIDth <integer> [:SENSe] :EVM:ULINk:PROFile:AUTO:SRS:BWIDth?
Example:	EVM:ULIN:PROF:AUTO:SRS:BWID 1 EVM:ULIN:PROF:AUTO:SRS:BWID?
Notes:	Changes to this parameter will not be applied until Update Changes command is sent. See “RB Parameter Manager (Uplink)” on page 1073 section for more details.
Dependencies:	Enabled when Detection is Auto and Auto Detect S-RS Active is ON
Preset:	0
State Saved:	Saved in instrument state.
Min:	0
Max:	3
Initial S/W Revision:	A.03.00
Help Map ID:	0

Transmission Comb (kTC)

Sets Transmission Comb (k_{TC}) of S-RS when Detection is Manual.

This parameter influences the starting frequency location of S-RS.

Key Path:	Meas Setup, Chan Profile Setup, Edit User Mapping, SRS Setup
Mode:	LTE, LTETDD
Remote Command:	[:SENSe] :EVM:ULINk:PROFile:USER<n>:SRS:TCOMb <integer> [:SENSe] :EVM:ULINk:PROFile:USER<n>:SRS:TCOMb?
Example:	EVM:ULIN:PROF:USER1:SRS:TCOM 1 EVM:ULIN:PROF:USER1:SRS:TCOM?
Notes:	Changes to this parameter will not be applied until Update Changes command is sent. See “RB Parameter Manager (Uplink)” on page 1073 section for more details.

Dependencies:	The range of sub op code <n> values is determined by the number of Users the user has configured. If the user attempts to remotely set or query a sub op code that is out of range, this will result in an error message. Enabled when Detection is Manual and S-RS Active is ON.
Preset:	0
State Saved:	Saved in instrument state.
Min:	0
Max:	1
Initial S/W Revision:	A.03.00
Help Map ID:	40839

Auto Detect Transmission Comb (kTC)

Sets Transmission Comb (k_{TC}) of S-RS when Detection is Auto.

Key Path:	Meas Setup, Chan Profile Setup, Edit User Mapping, SRS Setup
Mode:	LTE, LTETDD
Remote Command:	[:SENSe] :EVM:ULINk:PROFile:AUTO:SRS:TCOMb <integer> [:SENSe] :EVM:ULINk:PROFile:AUTO:SRS:TCOMb?
Example:	EVM:ULIN:PROF:AUTO:SRS:TCOM 1 EVM:ULIN:PROF:AUTO:SRS:TCOM?
Notes:	Changes to this parameter will not be applied until Update Changes command is sent. See “RB Parameter Manager (Uplink)” on page 1073 section for more details.
Dependencies:	Enabled when Detection is Auto and Auto Detect S-RS Active is ON.
Preset:	0
State Saved:	Saved in instrument state.
Min:	0
Max:	1
Initial S/W Revision:	A.03.00
Help Map ID:	0

Hopping Bandwidth (bhop)

Sets S-RS Hopping Bandwidth (b_{hop}) when Detection is Manual.

Key Path:	Meas Setup, Chan Profile Setup, Edit User Mapping, SRS Setup
-----------	---

LTE Modulation Analysis Measurement
Meas Setup (Measurement Setup)

Mode:	LTE, LTETDD
Remote Command:	[:SENSe] :EVM:ULINK:PROFile:USER<n>:SRS:HBWidth <integer> [:SENSe] :EVM:ULINK:PROFile:USER<n>:SRS:HBWidth?
Example:	EVM:ULIN:PROF:USER1:SRS:HBW 1 EVM:ULIN:PROF:USER1:SRS:HBW?
Notes:	Changes to this parameter will not be applied until Update Changes command is sent. See “RB Parameter Manager (Uplink)” on page 1073 section for more details.
Dependencies:	The range of sub op code <n> values is determined by the number of Users the user has configured. If the user attempts to remotely set or query a sub op code that is out of range, this will result in an error message. Enabled when Detection is Manual and S-RS Active is ON
Preset:	3
State Saved:	Saved in instrument state.
Min:	0
Max:	3
Initial S/W Revision:	A.03.00
Modified at S/W Revision:	A.06.00
Help Map ID:	40840

Auto Detect Hopping Bandwidth (bhop)

Sets S-RS Hopping Bandwidth (b_{hop}) when Detection is Auto.

Key Path:	Meas Setup, Chan Profile Setup, Edit User Mapping, SRS Setup
Mode:	LTE, LTETDD
Remote Command:	[:SENSe] :EVM:ULINK:PROFile:AUTO:SRS:HBWidth <integer> [:SENSe] :EVM:ULINK:PROFile:AUTO:SRS:HBWidth?
Example:	EVM:ULIN:PROF:AUTO:SRS:HBW 1 EVM:ULIN:PROF:AUTO:SRS:HBW?
Notes:	Changes to this parameter will not be applied until Update Changes command is sent. See “RB Parameter Manager (Uplink)” on page 1073 section for more details.
Dependencies:	Enabled when Detection is Auto and Auto Detect S-RS Active is ON
Preset:	3

State Saved:	Saved in instrument state.
Min:	0
Max:	3
Initial S/W Revision:	A.03.00
Modified at S/W Revision:	A.06.00
Help Map ID:	0

Frequency Domain Position (nRRC)

Sets the S-RS Frequency Domain Position (n_{RRC}) when Detection is Manual.

Key Path:	Meas Setup, Chan Profile Setup, Edit User Mapping, SRS Setup
Mode:	LTE, LTETDD
Remote Command:	[:SENSe] :EVM:ULINk:PROFile:USER<n>:SRS:FDPosition <integer> [:SENSe] :EVM:ULINk:PROFile:USER<n>:SRS:FDPosition?
Example:	EVM:ULIN:PROF:USER1:SRS:FDP 1 EVM:ULIN:PROF:USER1:SRS:FDP?
Notes:	Changes to this parameter will not be applied until Update Changes command is sent. See “RB Parameter Manager (Uplink)” on page 1073 section for more details.
Dependencies:	The range of sub op code <n> values is determined by the number of Users the user has configured. If the user attempts to remotely set or query a sub op code that is out of range, this will result in an error message. Enabled when Detection is Manual and S-RS Active is ON.
Preset:	0
State Saved:	Saved in instrument state.
Min:	0
Max:	23
Initial S/W Revision:	A.03.00
Modified at S/W Revision:	A.06.00
Help Map ID:	40841

LTE Modulation Analysis Measurement
Meas Setup (Measurement Setup)

Auto Detect Frequency Domain Position (nRRC)

Sets the S-RS Frequency Domain Position (n_{RRC}) when Detection is Auto.

Key Path:	Meas Setup, Chan Profile Setup, Edit User Mapping, SRS Setup
Mode:	LTE, LTETDD
Remote Command:	[:SENSe] :EVM:ULINk:PROFile:AUTO:SRS:FDPosition <integer> [:SENSe] :EVM:ULINk:PROFile:AUTO:SRS:FDPosition?
Example:	EVM:ULIN:PROF:AUTO:SRS:FDP 1 EVM:ULIN:PROF:AUTO:SRS:FDP?
Notes:	Changes to this parameter will not be applied until Update Changes command is sent. See “ RB Parameter Manager (Uplink) ” on page 1073 section for more details.
Dependencies:	Enabled when Detection is Auto and Auto Detect S-RS Active is ON
Preset:	0
State Saved:	Saved in instrument state.
Min:	0
Max:	23
Initial S/W Revision:	A.03.00
Modified at S/W Revision:	A.06.00
Help Map ID:	0

Subframe Configuration

Sets the value for srsSubframeConfiguration in Table 5.5.3.3–1 (FDD) or Table 5.5.3.3–2 (TDD) in TS 36.211 when Detection is Manual.

srsSubframeConfiguration determines T_{SFC} and D_{SFC} .

Key Path:	Meas Setup, Chan Profile Setup, Edit User Mapping, SRS Setup
Mode:	LTE, LTETDD
Remote Command:	[:SENSe] :EVM:ULINk:PROFile:USER<n>:SRS:SFCConfig <integer> [:SENSe] :EVM:ULINk:PROFile:USER<n>:SRS:SFCConfig?
Example:	EVM:ULIN:PROF:USER1:SRS:SFC 1 EVM:ULIN:PROF:USER1:SRS:SFC?
Notes:	Changes to this parameter will not be applied until Update Changes command is sent. See “ RB Parameter Manager (Uplink) ” on page 1073 section for more details.

Dependencies:	The range of sub op code <n> values is determined by the number of Users the user has configured. If the user attempts to remotely set or query a sub op code that is out of range, this will result in an error message. Enabled when Detection is Manual and S-RS Active is ON.
Preset:	0
State Saved:	Saved in instrument state.
Min:	0
Max:	15
Initial S/W Revision:	A.03.00
Help Map ID:	40842

Auto Detect Subframe Configuration

Sets the value for srsSubframeConfiguration in Table 5.5.3.3–1 (FDD) or Table 5.5.3.3–2 (TDD) in TS 36.211 when Detection is Auto.

Key Path:	Meas Setup, Chan Profile Setup, Edit User Mapping, SRS Setup
Mode:	LTE, LTETDD
Remote Command:	[:SENSE] :EVM:ULINk:PROFile:AUTO:SRS:SFCConfig <integer> [:SENSE] :EVM:ULINk:PROFile:AUTO:SRS:SFCConfig?
Example:	EVM:ULIN:PROF:AUTO:SRS:SFC 1 EVM:ULIN:PROF:AUTO:SRS:SFC?
Notes:	Changes to this parameter will not be applied until Update Changes command is sent. See “RB Parameter Manager (Uplink)” on page 1073 section for more details.
Dependencies:	Enabled when Detection is Auto and Auto Detect S-RS Active is ON
Preset:	0
State Saved:	Saved in instrument state.
Min:	0
Max:	15
Initial S/W Revision:	A.03.00
Help Map ID:	0

S-RS Power Boost

Sets S-RS Power Boost value when Detection is Manual.

This value specifies the average power for SRS.

LTE Modulation Analysis Measurement
Meas Setup (Measurement Setup)

NOTE All channel and signal powers are relative to the 0 dB level determined by the power of the channel/signal chosen for synchronization.

Key Path:	Meas Setup, Chan Profile Setup, Edit User Mapping, SRS Setup
Mode:	LTE, LTETDD
Remote Command:	[:SENSe] :EVM:ULINk:PROFile:USER<n>:SRS:PWRBoost <rel_ampl> [:SENSe] :EVM:ULINk:PROFile:USER<n>:SRS:PWRBoost?
Example:	EVM:ULIN:PROF:USER1:SRS:PWRB 1 EVM:ULIN:PROF:USER1:SRS:PWRB?
Notes:	Changes to this parameter will not be applied until Update Changes command is sent. See “ RB Parameter Manager (Uplink) ” on page 1073 section for more details.
Dependencies:	The range of sub op code <n> values is determined by the number of Users the user has configured. If the user attempts to remotely set or query a sub op code that is out of range, this will result in an error message. Enabled when Detection is Manual and S-RS Active is ON.
Preset:	0
State Saved:	Saved in instrument state.
Min:	-100
Max:	100
Initial S/W Revision:	A.03.00
Modified at S/W Revision:	A.04.20
Help Map ID:	40843

Auto Detect S-RS Power Boost

Sets the S-RS Power Boost value when Detection is Auto.

Key Path:	Meas Setup, Chan Profile Setup, Edit User Mapping, SRS Setup
Mode:	LTE, LTETDD
Remote Command:	[:SENSe] :EVM:ULINk:PROFile:AUTO:SRS:PWRBoost <rel_ampl> [:SENSe] :EVM:ULINk:PROFile:AUTO:SRS:PWRBoost?
Example:	EVM:ULIN:PROF:AUTO:SRS:PWRB 1 EVM:ULIN:PROF:AUTO:SRS:PWRB?

Notes:	Changes to this parameter will not be applied until Update Changes command is sent. See “RB Parameter Manager (Uplink)” on page 1073 section for more details.
Dependencies:	Enabled when Detection is Auto and Auto Detect S-RS Active is ON.
Preset:	0
State Saved:	Saved in instrument state.
Min:	-100
Max:	100
Initial S/W Revision:	A.03.00
Modified at S/W Revision:	A.04.20
Help Map ID:	0

Configuration Index (ISRS)

Sets the S-RS Configuration Index (I_{SRS}) when Detection is Manual. (3GPP TS 36.213 V8.5.0 8.2 Table 8.2-1~2)

The S-RS Configuration Index value determines S-RS periodicity and subframe offset configuration from Table 8.2-1 for FDD and Table 8.2-2 for TDD in 3GPP TS 36.213.

Key Path:	Meas Setup, Chan Profile Setup, Edit User Mapping, SRS Setup
Mode:	LTE, LTETDD
Remote Command:	[:SENSE] :EVM:ULINK:PROFile:USER<n>:SRS:CINdEx <integer> [:SENSE] :EVM:ULINK:PROFile:USER<n>:SRS:CINdEx?
Example:	EVM:ULIN:PROF:USER1:SRS:CIND 1 EVM:ULIN:PROF:USER1:SRS:CIND?
Notes:	Changes to this parameter will not be applied until Update Changes command is sent. See “RB Parameter Manager (Uplink)” on page 1073 section for more details.
Dependencies:	The range of sub op code <n> values is determined by the number of Users the user has configured. If the user attempts to remotely set or query a sub op code that is out of range, this will result in an error message. Enabled when Detection is Manual and S-RS Active is ON
Preset:	0
State Saved:	Saved in instrument state.
Min:	0
Max:	1023
Initial S/W Revision:	A.03.00

Help Map ID:	40844
--------------	-------

Auto Detect Configuration Index (ISRS)

Sets the S-RS Configuration Index (I_{SRS}) when Detection is Auto. (3GPP TS 36.213 V8.5.0 8.2 Table 8.2-1~2)

Key Path:	Meas Setup, Chan Profile Setup, Edit User Mapping, SRS Setup
Mode:	LTE, LTETDD
Remote Command:	[:SENSe] :EVM:ULINK:PROFile:AUTO:SRS:CINDeX <integer> [:SENSe] :EVM:ULINK:PROFile:AUTO:SRS:CINDeX?
Example:	EVM:ULIN:PROF:AUTO:SRS:CIND 1 EVM:ULIN:PROF:AUTO:SRS:CIND?
Notes:	Changes to this parameter will not be applied until Update Changes command is sent. See “RB Parameter Manager (Uplink)” on page 1073 section for more details.
Dependencies:	Enabled when Detection is Auto and Auto Detect S-RS Active is ON
Preset:	0
State Saved:	Saved in instrument state.
Min:	0
Max:	1023
Initial S/W Revision:	A.03.00
Help Map ID:	0

S-RS Sync Slot

Sets the S-RS Sync Slot when Detection is Manual.

This value specifies the index of the slot to use for initial synchronization. The demodulator searches for the slot with the characteristics specified in Channel Parameters and the slot that matches the Channel Parameters with the highest correlation will be assigned the slot number given in the Sync Slot parameter.

When Sync Slot is set to Auto, the demod algorithm may automatically determine the best time slot to synchronize to. This approach simplifies parameter entry and provides easier setup. However, the complexity of the algorithm makes it rather slow and prone to errors in the presence of noise.

Key Path:	Meas Setup, Chan Profile Setup, Edit User Mapping
Mode:	LTE, LTETDD

Remote Command:	<pre>[:SENSE] :EVM:ULINK:PROFile:USER<n>:SRS:SSLot <integer> [:SENSE] :EVM:ULINK:PROFile:USER<n>:SRS:SSLot? [:SENSE] :EVM:ULINK:PROFile:USER<n>:SRS:SSLot:AUTO OFF ON 0 1 [:SENSE] :EVM:ULINK:PROFile:USER<n>:SRS:SSLot:AUTO?</pre>
Example:	<pre>EVM:ULIN:PROF:USER1:SRS:SSL 1 EVM:ULIN:PROF:USER1:SRS:SSL? EVM:ULIN:PROF:USER1:SRS:SSL:AUTO 1 EVM:ULIN:PROF:USER1:SRS:SSL:AUTO?</pre>
Notes:	Changes to this parameter will not be applied until Update Changes command is sent. See “RB Parameter Manager (Uplink)” on page 1073 section for more details.
Dependencies:	<p>The range of sub op code <n> values is determined by the number of Users the user has configured. Max value for n=50</p> <p>If the user attempts to remotely set or query a sub op code that is out of range, this will result in an error message.</p> <p>S-RS Sync Slot is enabled when S-RS Active is ON, Detection is Manual and S-RS Sync Slot Auto is OFF.</p> <p>S-RS Sync Slot Auto is enabled when S-RS Active is ON and Detection is Manual</p>
Preset:	1 ON
State Saved:	Saved in instrument state.
Min:	1
Max:	19
Initial S/W Revision:	A.03.00
Help Map ID:	40846

Auto Detect S-RS Sync Slot

Sets the S-RS Sync Slot when Detection is Auto.

Key Path:	Meas Setup, Chan Profile Setup, Edit User Mapping
Mode:	LTE, LTETDD

LTE Modulation Analysis Measurement
Meas Setup (Measurement Setup)

Remote Command:	[:SENSe]:EVM:ULINK:PROFile:AUTO:SRS:SSLot <integer> [:SENSe]:EVM:ULINK:PROFile:AUTO:SRS:SSLot? [:SENSe]:EVM:ULINK:PROFile:AUTO:SRS:SSLot:AUTO OFF ON 0 1 [:SENSe]:EVM:ULINK:PROFile:AUTO:SRS:SSLot:AUTO?
Example:	EVM:ULIN:PROF:AUTO:SRS:SSL 1 EVM:ULIN:PROF:AUTO:SRS:SSL? EVM:ULIN:PROF:AUTO:SRS:SSL:AUTO 1 EVM:ULIN:PROF:AUTO:SRS:SSL:AUTO?
Notes:	Changes to this parameter will not be applied until Update Changes command is sent. See “RB Parameter Manager (Uplink)” on page 1073 section for more details.
Dependencies:	Enabled when Detection is Auto and Auto Detect S-RS Active is ON.
Preset:	1 ON
State Saved:	Saved in instrument state.
Min:	1
Max:	19
Initial S/W Revision:	A.03.00
Help Map ID:	0

Max UpPTS

Sets the value of srsMaxUpPts to indicate whether or not $m_{SRS,0}$ reconfiguration is enabled for UpPTS when Detection is Manual, where $m_{SRS,0}$ is given by Table 5.5.3.2–1 through Table 5.5.3.2–4 for each uplink bandwidth in 3GPP TS36.211 v8.5.0.

Key Path:	Meas Setup, Chan Profile Setup, Edit User Mapping, SRS Setup
Mode:	LTETDD
Remote Command:	[:SENSe]:EVM:ULINK:PROFile:USER<n>:SRS:MUPTs OFF ON 0 1 [:SENSe]:EVM:ULINK:PROFile:USER<n>:SRS:MUPTs?
Example:	EVM:ULIN:PROF:USER1:SRS:MUPT 0 EVM:ULIN:PROF:USER1:SRS:MUPT?
Notes:	Changes to this parameter will not be applied until Update Changes command is sent. See “RB Parameter Manager (Uplink)” on page 1073 section for more details.

Dependencies:	The range of sub op code <n> values is determined by the number of Users the user has configured. Enabled when the mode is LTE TDD, Detection is Manual, and S-RS Active is ON.
Preset:	OFF
State Saved:	Saved in instrument state.
Initial S/W Revision:	A.03.00
Help Map ID:	40845

Key Path:	Meas Setup, Chan Profile Setup, Edit User Mapping, SRS Setup
Mode:	LTETDD
Remote Command:	[:SENSE] :EVM:ULINK:PROfile:AUTO:SRS:MUPTs OFF ON 0 1 [:SENSE] :EVM:ULINK:PROfile:AUTO:SRS:MUPTs?
Example:	EVM:ULIN:PROF:AUTO:SRS:MUPT 0 EVM:ULIN:PROF:AUTO:SRS:MUPT?
Notes:	Changes to this parameter will not be applied until Update Changes command is sent. See “ RB Parameter Manager (Uplink) ” on page 1073 section for more details.
Dependencies:	Enabled when the mode is LTE TDD, Detection is Auto, and Auto Detect S-RS Active is ON.
Preset:	OFF
State Saved:	Saved in instrument state.
Initial S/W Revision:	A.03.00
Help Map ID:	0

S-RS NraS1

Sets the format number for PRACH in subframe1’s UpPTS, which is derived from 3GPP TS 36.211 V8.5.0 5.7 Table5.7.1–4.

Key Path:	Meas Setup, Chan Profile Setup, Edit User Mapping, SRS Setup
Mode:	LTETDD
Remote Command:	[:SENSE] :EVM:ULINK:PROfile:USER<n>:SRS:NRA:SONe <integer> [:SENSE] :EVM:ULINK:PROfile:USER<n>:SRS:NRA:SONe?
Example:	EVM:ULIN:PROF:USER1:SRS:NRA:SON 1 EVM:ULIN:PROF:USER1:SRS:NRA:SON?

LTE Modulation Analysis Measurement
Meas Setup (Measurement Setup)

Notes:	Changes to this parameter will not be applied until Update Changes command is sent. See “RB Parameter Manager (Uplink)” on page 1073 section for more detail.
Dependencies:	The range of sub op code <n> values is determined by the number of Users the user has configured. Max value for n=50 If the user attempts to remotely set or query a sub op code that is out of range, this will result in an error message. Enabled when the mode is LTE TDD, Detection is Manual and S-RS Active is ON.
Preset:	0
State Saved:	Saved in instrument state.
Min:	0
Max:	6
Initial S/W Revision:	A.03.00
Help Map ID:	29096

Auto Detect S-RS NraS1

Sets S-RS NraS1 when Auto Detection is On.

Key Path:	Meas Setup, Chan Profile Setup, Edit User Mapping, SRS Setup
Mode:	LTETDD
Remote Command:	[:SENSE] :EVM:ULINK:PROFile:AUTO:SRS:NRA:SONe <integer> [:SENSE] :EVM:ULINK:PROFile:AUTO:SRS:NRA:SONe?
Example:	EVM:ULIN:PROF:AUTO:SRS:NRA:SON 1 EVM:ULIN:PROF:AUTO:SRS:NRA:SON?
Notes:	Changes to this parameter will not be applied until Update Changes command is sent. See “RB Parameter Manager (Uplink)” on page 1073 section for more detail.
Dependencies:	Enabled when the mode is LTE TDD, Detection is Auto and Auto Detect S-RS Active is ON.
Preset:	0
State Saved:	Saved in instrument state.
Min:	0
Max:	6
Initial S/W Revision:	A.03.00
Help Map ID:	0

S-RS NraS6

Sets the format number for PRACH in subframe6's UpPTS, which is derived from 3GPP TS 36.211 V8.5.0 5.7 Table5.7.1-4.

Key Path:	Meas Setup, Chan Profile Setup, Edit User Mapping, SRS Setup
Mode:	LTETDD
Remote Command:	[:SENSe] :EVM:ULINk:PROFile:USER<n>:SRS:NRA:SSIX <integer> [:SENSe] :EVM:ULINk:PROFile:USER<n>:SRS:NRA:SSIX?
Example:	EVM:ULIN:PROF:USER1:SRS:NRA:SSIX 1 EVM:ULIN:PROF:USER1:SRS:NRA:SSIX?
Notes:	Changes to this parameter will not be applied until Update Changes command is sent. See “RB Parameter Manager (Uplink)” on page 1073 section for more detail.
Dependencies:	The range of sub op code <n> values is determined by the number of Users the user has configured. Max value for n=50 If the user attempts to remotely set or query a sub op code that is out of range, this will result in an error message. Enabled when the mode is LTE TDD, Detection is Manual and S-RS Active is ON.
Preset:	0
State Saved:	Saved in instrument state.
Min:	0
Max:	6
Initial S/W Revision:	A.03.00
Help Map ID:	29099

Auto Detect S-RS NraS6

Sets S-RS NraS6 when Auto Detection is On.

Key Path:	Meas Setup, Chan Profile Setup, Edit User Mapping, SRS Setup
Mode:	LTETDD
Remote Command:	[:SENSe] :EVM:ULINk:PROFile:AUTO:SRS:NRA:SSIX <integer> [:SENSe] :EVM:ULINk:PROFile:AUTO:SRS:NRA:SSIX?
Example:	EVM:ULIN:PROF:AUTO:SRS:NRA:SSIX 1 EVM:ULIN:PROF:AUTO:SRS:NRA:SSIX?

LTE Modulation Analysis Measurement
Meas Setup (Measurement Setup)

Notes:	Changes to this parameter will not be applied until Update Changes command is sent. See “ RB Parameter Manager (Uplink) ” on page 1073 section for more detail.
Dependencies:	Enabled when the mode is LTE TDD, Detection is Auto and Auto Detect S-RS Active is ON.
Preset:	0
State Saved:	Saved in instrument state.
Min:	0
Max:	6
Initial S/W Revision:	A.03.00
Help Map ID:	0

OK/Cancel

Displays a menu that enables changes to the parameters on the dialog to be applied or cancelled.

This menu appears when the Cancel (Esc) hard key is pressed with no active function available.

Mode:	LTE, LTETDD
Initial S/W Revision:	Prior to A.02.00
Modified at S/W Revision:	A.03.00
Help Map ID:	Use 29195

OK

Applies all changes made to the parameters on the dialog then exits the dialog.

Mode:	LTE, LTETDD
Initial S/W Revision:	Prior to A.02.00
Modified at S/W Revision:	A.03.00
Help Map ID:	Use 29196

Cancel

Cancels all changes made to the parameters on the dialog then exits the dialog.

Mode:	LTE, LTETDD
Initial S/W Revision:	Prior to A.02.00
Modified at S/W Revision:	A.03.00
Help Map ID:	Use 29197

RB Parameter Manager (Uplink)

Reduces the time it takes to configure channel profile related parameters with SCPI commands.

The SCPI command parameters shown below are managed in this scheme.

Note that changes to the parameters are not applied until the Update Changes command is sent. See “Update Changes (Uplink)” on page 1079 section for more details.

[:SENSe]:EVM:ULINK:PROFile:ADD:USER
[:SENSe]:EVM:ULINK:PROFile:AUTO:CID
[:SENSe]:EVM:ULINK:PROFile:AUTO:HOPPing:GROup
[:SENSe]:EVM:ULINK:PROFile:AUTO:HOPPing:SEQuence
[:SENSe]:EVM:ULINK:PROFile:AUTO:RNTI
[:SENSe]:EVM:ULINK:PROFile:AUTO:SFNumber
[:SENSe]:EVM:ULINK:PROFile:AUTO:PRACH:ACTive
[:SENSe]:EVM:ULINK:PROFile:AUTO:PRACH:CINdex
[:SENSe]:EVM:ULINK:PROFile:AUTO:PRACH:CSSet
[:SENSe]:EVM:ULINK:PROFile:AUTO:PRACH:PINdex
[:SENSe]:EVM:ULINK:PROFile:AUTO:PRACH:LRsindex
[:SENSe]:EVM:ULINK:PROFile:AUTO:PRACH:NCSConfig
[:SENSe]:EVM:ULINK:PROFile:AUTO:PRACH:NRAPrb
[:SENSe]:EVM:ULINK:PROFile:AUTO:PRACH:PWRBoost
[:SENSe]:EVM:ULINK:PROFile:AUTO:PRACH:SRESource
[:SENSe]:EVM:ULINK:PROFile:AUTO:PUCCh:ACTive
[:SENSe]:EVM:ULINK:PROFile:AUTO:PUCCh:CSHift
[:SENSe]:EVM:ULINK:PROFile:AUTO:PUCCh:DMRS:GROup
[:SENSe]:EVM:ULINK:PROFile:AUTO:PUCCh:DMRS:PARams
[:SENSe]:EVM:ULINK:PROFile:AUTO:PUCCh:DMRS:PWRBoost
[:SENSe]:EVM:ULINK:PROFile:AUTO:PUCCh:FORMat
[:SENSe]:EVM:ULINK:PROFile:AUTO:PUCCh:N:ONE
[:SENSe]:EVM:ULINK:PROFile:AUTO:PUCCh:N:TWO
[:SENSe]:EVM:ULINK:PROFile:AUTO:PUCCh:NCS:ONE
[:SENSe]:EVM:ULINK:PROFile:AUTO:PUCCh:NRB:TWO

LTE Modulation Analysis Measurement
Meas Setup (Measurement Setup)

[:SENSe]:EVM:ULINK:PROFile:AUTO:PUCCh:OS
[:SENSe]:EVM:ULINK:PROFile:AUTO:PUCCh:PWRBoost
[:SENSe]:EVM:ULINK:PROFile:AUTO:PUCCh:RB
[:SENSe]:EVM:ULINK:PROFile:AUTO:PUCCh:SHIFt
[:SENSe]:EVM:ULINK:PROFile:AUTO:PUCCh:SSLot
[:SENSe]:EVM:ULINK:PROFile:AUTO:PUCCh:SSLot:AUTO
[:SENSe]:EVM:ULINK:PROFile:AUTO:PUSCh:ACTive
[:SENSe]:EVM:ULINK:PROFile:AUTO:PUSCh:DMRS:CSHift
[:SENSe]:EVM:ULINK:PROFile:AUTO:PUSCh:DMRS:GROup
[:SENSe]:EVM:ULINK:PROFile:AUTO:PUSCh:DMRS:ONE
[:SENSe]:EVM:ULINK:PROFile:AUTO:PUSCh:DMRS:PARams
[:SENSe]:EVM:ULINK:PROFile:AUTO:PUSCh:DMRS:PWRBoost
[:SENSe]:EVM:ULINK:PROFile:AUTO:PUSCh:DMRS:SEQuence
[:SENSe]:EVM:ULINK:PROFile:AUTO:PUSCh:DMRS:TWO
[:SENSe]:EVM:ULINK:PROFile:AUTO:PUSCh:DSS
[:SENSe]:EVM:ULINK:PROFile:AUTO:PUSCh:FHOPping
[:SENSe]:EVM:ULINK:PROFile:AUTO:PUSCh:MODulation:TYPE
[:SENSe]:EVM:ULINK:PROFile:AUTO:PUSCh:NRBHo
[:SENSe]:EVM:ULINK:PROFile:AUTO:PUSCh:NSB
[:SENSe]:EVM:ULINK:PROFile:AUTO:PUSCh:PWRBoost
[:SENSe]:EVM:ULINK:PROFile:AUTO:PUSCh:RB:END
[:SENSe]:EVM:ULINK:PROFile:AUTO:PUSCh:RB:STARt
[:SENSe]:EVM:ULINK:PROFile:AUTO:PUSCh:SSLot
[:SENSe]:EVM:ULINK:PROFile:AUTO:PUSCh:SSLot:AUTO
[:SENSe]:EVM:ULINK:PROFile:AUTO:SRS:ACTive
[:SENSe]:EVM:ULINK:PROFile:AUTO:SRS:BCONfig
[:SENSe]:EVM:ULINK:PROFile:AUTO:SRS:BWIDth
[:SENSe]:EVM:ULINK:PROFile:AUTO:SRS:CINDeX
[:SENSe]:EVM:ULINK:PROFile:AUTO:SRS:CSHift
[:SENSe]:EVM:ULINK:PROFile:AUTO:SRS:FDPosition

[[:SENSe]:EVM:ULINK:PROFile:AUTO:SRS:HBWidth
[[:SENSe]:EVM:ULINK:PROFile:AUTO:SRS:MUPTs
[[:SENSe]:EVM:ULINK:PROFile:AUTO:SRS:PWRBoost
[[:SENSe]:EVM:ULINK:PROFile:AUTO:SRS:SFConfig
[[:SENSe]:EVM:ULINK:PROFile:AUTO:SRS:SSLot
[[:SENSe]:EVM:ULINK:PROFile:AUTO:SRS:SSLot:AUTO
[[:SENSe]:EVM:ULINK:PROFile:AUTO:SRS:TCOMb
[[:SENSe]:EVM:ULINK:PROFile:USER(1:50):CID
[[:SENSe]:EVM:ULINK:PROFile:USER(1:50):DELete
[[:SENSe]:EVM:ULINK:PROFile:USER(1:50):HOPPing:GROup
[[:SENSe]:EVM:ULINK:PROFile:USER(1:50):HOPPing:SEQuence
[[:SENSe]:EVM:ULINK:PROFile:USER(1:50):RNTI
[[:SENSe]:EVM:ULINK:PROFile:USER(1:50):SFNumber
[[:SENSe]:EVM:ULINK:PROFile:USER(1:50):PRACH:ACTive
[[:SENSe]:EVM:ULINK:PROFile:USER(1:50):PRACH:CINDeX
[[:SENSe]:EVM:ULINK:PROFile:USER(1:50):PRACH:CSSEt
[[:SENSe]:EVM:ULINK:PROFile:USER(1:50):PRACH:PINDeX
[[:SENSe]:EVM:ULINK:PROFile:USER(1:50):PRACH:LRSindex
[[:SENSe]:EVM:ULINK:PROFile:USER(1:50):PRACH:NCSEConfig
[[:SENSe]:EVM:ULINK:PROFile:USER(1:50):PRACH:NRAPrb
[[:SENSe]:EVM:ULINK:PROFile:USER(1:50):PRACH:PWRBoost
[[:SENSe]:EVM:ULINK:PROFile:USER(1:50):PRACH:SRESource
[[:SENSe]:EVM:ULINK:PROFile:USER(1:50):PUCCh:ACTive
[[:SENSe]:EVM:ULINK:PROFile:USER(1:50):PUCCh:ADD:SLOT
[[:SENSe]:EVM:ULINK:PROFile:USER(1:50):PUCCh:CSHift
[[:SENSe]:EVM:ULINK:PROFile:USER(1:50):PUCCh:CSHift:COUple
[[:SENSe]:EVM:ULINK:PROFile:USER(1:50):PUCCh:DMRS:GROup
[[:SENSe]:EVM:ULINK:PROFile:USER(1:50):PUCCh:DMRS:GROup:COUple
[[:SENSe]:EVM:ULINK:PROFile:USER(1:50):PUCCh:DMRS:PARams

LTE Modulation Analysis Measurement
Meas Setup (Measurement Setup)

[[:SENSe]:EVM:ULINK:PROFile:USER(1:50):PUCCh:DMRS:PWRBoost
[[:SENSe]:EVM:ULINK:PROFile:USER(1:50):PUCCh:DMRS:PWRBoost:COUPle
[[:SENSe]:EVM:ULINK:PROFile:USER(1:50):PUCCh:FORMat
[[:SENSe]:EVM:ULINK:PROFile:USER(1:50):PUCCh:FORMat:COUPle
[[:SENSe]:EVM:ULINK:PROFile:USER(1:50):PUCCh:N:ONE
[[:SENSe]:EVM:ULINK:PROFile:USER(1:50):PUCCh:N:TWO
[[:SENSe]:EVM:ULINK:PROFile:USER(1:50):PUCCh:NCS:ONE
[[:SENSe]:EVM:ULINK:PROFile:USER(1:50):PUCCh:NRB:TWO
[[:SENSe]:EVM:ULINK:PROFile:USER(1:50):PUCCh:OS
[[:SENSe]:EVM:ULINK:PROFile:USER(1:50):PUCCh:OS:COUPle
[[:SENSe]:EVM:ULINK:PROFile:USER(1:50):PUCCh:PWRBoost
[[:SENSe]:EVM:ULINK:PROFile:USER(1:50):PUCCh:PWRBoost:COUPle
[[:SENSe]:EVM:ULINK:PROFile:USER(1:50):PUCCh:RB
[[:SENSe]:EVM:ULINK:PROFile:USER(1:50):PUCCh:RB:COUPle
[[:SENSe]:EVM:ULINK:PROFile:USER(1:50):PUCCh:SHIFt
[[:SENSe]:EVM:ULINK:PROFile:USER(1:50):PUCCh:SLOT(0:19):CSHift
[[:SENSe]:EVM:ULINK:PROFile:USER(1:50):PUCCh:SLOT(0:19):DELete
[[:SENSe]:EVM:ULINK:PROFile:USER(1:50):PUCCh:SLOT(0:19):DMRS:GROup
[[:SENSe]:EVM:ULINK:PROFile:USER(1:50):PUCCh:SLOT(0:19):DMRS:PWRBoost
[[:SENSe]:EVM:ULINK:PROFile:USER(1:50):PUCCh:SLOT(0:19):FORMat
[[:SENSe]:EVM:ULINK:PROFile:USER(1:50):PUCCh:SLOT(0:19):OS
[[:SENSe]:EVM:ULINK:PROFile:USER(1:50):PUCCh:SLOT(0:19):PWRBoost
[[:SENSe]:EVM:ULINK:PROFile:USER(1:50):PUCCh:SLOT(0:19):RB
[[:SENSe]:EVM:ULINK:PROFile:USER(1:50):PUCCh:SSLot
[[:SENSe]:EVM:ULINK:PROFile:USER(1:50):PUCCh:SSLot:AUTO
[[:SENSe]:EVM:ULINK:PROFile:USER(1:50):PUSCh:ACTive
[[:SENSe]:EVM:ULINK:PROFile:USER(1:50):PUSCh:ADD:SLOT
[[:SENSe]:EVM:ULINK:PROFile:USER(1:50):PUSCh:CTNB
[[:SENSe]:EVM:ULINK:PROFile:USER(1:50):PUSCh:CTNB:COUPle
[[:SENSe]:EVM:ULINK:PROFile:USER(1:50):PUSCh:DMRS:CSHift
[[:SENSe]:EVM:ULINK:PROFile:USER(1:50):PUSCh:DMRS:CSHift:COUPle

[:SENSe]:EVM:ULINK:PROFile:USER(1:50):PUSCh:DMRS:GROup
[:SENSe]:EVM:ULINK:PROFile:USER(1:50):PUSCh:DMRS:GROup:COUPle
[:SENSe]:EVM:ULINK:PROFile:USER(1:50):PUSCh:DMRS:ONE
[:SENSe]:EVM:ULINK:PROFile:USER(1:50):PUSCh:DMRS:PARams
[:SENSe]:EVM:ULINK:PROFile:USER(1:50):PUSCh:DMRS:PWRBoost
[:SENSe]:EVM:ULINK:PROFile:USER(1:50):PUSCh:DMRS:PWRBoost:COUPle
[:SENSe]:EVM:ULINK:PROFile:USER(1:50):PUSCh:DMRS:SEQuence
[:SENSe]:EVM:ULINK:PROFile:USER(1:50):PUSCh:DMRS:SEQuence:COUPle
[:SENSe]:EVM:ULINK:PROFile:USER(1:50):PUSCh:DMRS:TWO
[:SENSe]:EVM:ULINK:PROFile:USER(1:50):PUSCh:DSS
[:SENSe]:EVM:ULINK:PROFile:USER(1:50):PUSCh:FHOPping
[:SENSe]:EVM:ULINK:PROFile:USER(1:50):PUSCh:MODulation:TYPE
[:SENSe]:EVM:ULINK:PROFile:USER(1:50):PUSCh:MODulation:TYPE:COUPle
[:SENSe]:EVM:ULINK:PROFile:USER(1:50):PUSCh:NRBHo
[:SENSe]:EVM:ULINK:PROFile:USER(1:50):PUSCh:NSB
[:SENSe]:EVM:ULINK:PROFile:USER(1:50):PUSCh:PWRBoost
[:SENSe]:EVM:ULINK:PROFile:USER(1:50):PUSCh:PWRBoost:COUPle
[:SENSe]:EVM:ULINK:PROFile:USER(1:50):PUSCh:RB:END
[:SENSe]:EVM:ULINK:PROFile:USER(1:50):PUSCh:RB:END:COUPle
[:SENSe]:EVM:ULINK:PROFile:USER(1:50):PUSCh:RB:STARt
[:SENSe]:EVM:ULINK:PROFile:USER(1:50):PUSCh:RB:STARt:COUPle
[:SENSe]:EVM:ULINK:PROFile:USER(1:50):PUSCh:SLOT(0:19):CTNB
[:SENSe]:EVM:ULINK:PROFile:USER(1:50):PUSCh:SLOT(0:19):DELete
[:SENSe]:EVM:ULINK:PROFile:USER(1:50):PUSCh:SLOT(0:19):DMRS:CSHift
[:SENSe]:EVM:ULINK:PROFile:USER(1:50):PUSCh:SLOT(0:19):DMRS:GROup
[:SENSe]:EVM:ULINK:PROFile:USER(1:50):PUSCh:SLOT(0:19):DMRS:PWRBoost
[:SENSe]:EVM:ULINK:PROFile:USER(1:50):PUSCh:SLOT(0:19):DMRS:SEQuence
d
[:SENSe]:EVM:ULINK:PROFile:USER(1:50):PUSCh:SLOT(0:19):MODulation:TYPE
[:SENSe]:EVM:ULINK:PROFile:USER(1:50):PUSCh:SLOT(0:19):PWRBoost
[:SENSe]:EVM:ULINK:PROFile:USER(1:50):PUSCh:SLOT(0:19):RB:END
[:SENSe]:EVM:ULINK:PROFile:USER(1:50):PUSCh:SLOT(0:19):RB:STARt

LTE Modulation Analysis Measurement
Meas Setup (Measurement Setup)

[[:SENSe]:EVM:ULINK:PROFile:USER(1:50):PUSCh:SSLot
[[:SENSe]:EVM:ULINK:PROFile:USER(1:50):PUSCh:SSLot:AUTO
[[:SENSe]:EVM:ULINK:PROFile:USER(1:50):SRS:ACTive
[[:SENSe]:EVM:ULINK:PROFile:USER(1:50):SRS:BCONfig
[[:SENSe]:EVM:ULINK:PROFile:USER(1:50):SRS:BWIDth
[[:SENSe]:EVM:ULINK:PROFile:USER(1:50):SRS:CINdex
[[:SENSe]:EVM:ULINK:PROFile:USER(1:50):SRS:CSHift
[[:SENSe]:EVM:ULINK:PROFile:USER(1:50):SRS:FDPosition
[[:SENSe]:EVM:ULINK:PROFile:USER(1:50):SRS:HBWidth
[[:SENSe]:EVM:ULINK:PROFile:USER(1:50):SRS:MUPTs
[[:SENSe]:EVM:ULINK:PROFile:USER(1:50):SRS:PWRBoost
[[:SENSe]:EVM:ULINK:PROFile:USER(1:50):SRS:SFConfig
[[:SENSe]:EVM:ULINK:PROFile:USER(1:50):SRS:SSLot
[[:SENSe]:EVM:ULINK:PROFile:USER(1:50):SRS:SSLot:AUTO
[[:SENSe]:EVM:ULINK:PROFile:USER(1:50):SRS:TCOMb

This feature supports the following operations:

- “Update Changes (Uplink)” on page 1079 command, which applies pending changes to parameters.
- “Ignore Changes (Uplink)” on page 1079 Ignore Changes command, which discards pending changes to parameters.
- “Clear Changes (Uplink)” on page 1079 command, which clears all existing RB mapping information for uplink.

The Update Changes and Ignore Changes commands behave similarly to the OK and Cancel buttons on user interface dialogs, respectively.

For example, to clear existing RB mapping information and configure one user with one PUSCH slot with RB End set to 49, send the following sequence in order. Note that the Clear Changes command is not required just after mode preset since there is no RB mapping information by default.

```
[[:SENSe]:EVM:ULINK:PROFile:ADD:USER  
[[:SENSe]:EVM:ULINK:PROFile:USER1:PUSCh:ADD:SLOT  
[[:SENSe]:EVM:ULINK:PROFile:USER1:PUSCh:RB:END 49  
[[:SENSe]:EVM:ULINK:PROFile:UPDate
```

Update Changes (Uplink)

SCPI Only. This command updates changes sent after last UPDate or preset.

Mode:	LTE, LTETDD
Remote Command:	[:SENSE] :EVM:ULINK:PROFile:UPDate
Example:	EVM:ULIN:PROF:UPD
Initial S/W Revision:	A.03.00
Help Map ID:	0

Clear Changes (Uplink)

SCPI Only. This command clears allocated resource blocks and delete all Users

Mode:	LTE, LTETDD
Remote Command:	[:SENSE] :EVM:ULINK:PROFile:CLEar
Example:	EVM:ULIN:PROF:CLE
Initial S/W Revision:	A.03.00
Help Map ID:	0

Ignore Changes (Uplink)

SCPI Only. This command ignores (clears) changes that are not updated.

Mode:	LTE, LTETDD
Remote Command:	[:SENSE] :EVM:ULINK:PROFile:IGNore
Example:	EVM:ULIN:PROF:IGN
Initial S/W Revision:	A.03.00
Help Map ID:	0

Count Number of Users (Uplink)

SCPI Only. This command returns the number of added users.

Mode:	LTE, LTETDD
Remote Command:	[:SENSE] :EVM:ULINK:PROFile:COUNT?
Example:	EVM:ULIN:PROF:COUN?
Initial S/W Revision:	A.03.00
Help Map ID:	0

LTE Modulation Analysis Measurement
Meas Setup (Measurement Setup)

Count Number of PUCCH Slots (Uplink)

SCPI Only. This command returns the number of added PUCCH slots.

Mode:	LTE, LTETDD
Remote Command:	[:SENSe] :EVM:ULINk:PROFile:USER<n>:PUCCh:COUNT?
Example:	EVM:ULIN:PROF:USER2:PUCCh:COUN?
Dependencies:	The range of sub op code <n> values is determined by the number of Users the user has configured. If the user attempts to remotely set or query a sub op code that is out of range, this will result in an error message.
Initial S/W Revision:	A.03.00
Help Map ID:	0

Count Number of PUSCH Slots (Uplink)

SCPI Only. This command returns the number of added PUSCH slots.

Mode:	LTE, LTETDD
Remote Command:	[:SENSe] :EVM:ULINk:PROFile:USER<n>:PUSCh:COUNT?
Example:	EVM:ULIN:PROF:USER2:PUSCh:COUN?
Dependencies:	The range of sub op code <n> values is determined by the number of Users the user has configured. If the user attempts to remotely set or query a sub op code that is out of range, this will result in an error message.
Initial S/W Revision:	A.03.00
Help Map ID:	0

Copy Auto -> Manual

See [Copy Auto -> Manual@29241@i](#).

Key Path:	Meas Setup, Chan Profile Setup
Help Map ID:	Use 29241

Decode

Displays a menu that enables you to configure RA-RNTI and TPC-RNTI search ranges and what level of decoding to perform on PBCH, PCFICH, PDCCH, PDSCH, and PUSCH.

Key Path:	Meas Setup
-----------	-------------------

Initial S/W Revision:	A.06.00
Help Map ID:	29249

Decode Type

Displays a menu that enables you to select the decoding type of each channel. The decoded symbols will be displayed in the Decoded Symbol Table.

Key Path:	Meas Setup, Decode
Initial S/W Revision:	A.06.00
Help Map ID:	29293

PBCH Decoding

Selects the decoding type of the PBCH. It specifies how much coding to undo before showing the Master Information Block (MIB) bits from PBCH on the Decoded Symbol Table. See 3GPP TS 36.212, Section 5.3.1 for a diagram of the coding operations performed on PBCH.

The following is a list of the available PBCH decoding type selections and the resulting bits:

- NONE – None, no bits for this channel will be shown on the Decoded Symbol Table.
- DESCrambled – Descrambled, 480 (Normal CP) or 432 (Extended CP) descrambled (rate-matched) bits for each subframe 0 in a frame
- DRMatched – DeRateMatched, 120 deratematched (channel coded) bits for each subframe 0 in a frame
- DECoded – 40 (information bits + CRC) bits for each subframe 0 in a frame

NOTE

The PBCH decoder is On when PBCH Decoding is not set to None or when PHICH Duration or PHICH Allocation (Ng) are set to Auto Detect.

Key Path:	Meas Setup, Decode, Decode Type
Mode:	LTE, LTETDD
Remote Command:	[:SENSE] :EVM:DLINk:DECCode:PBCH NONE DESCrambled DRMatched DECoded [:SENSE] :EVM:DLINk:DECCode:PBCH?
Example:	EVM:DLIN:DEC:PBCH NONE EVM:DLIN:DEC:PBCH?
Notes:	Available when Direction is Downlink.
State Saved:	Saved in instrument state.
Range:	None Descrambled DeRateMatched Decoded

Initial S/W Revision:	A.06.00
Help Map ID:	29307

PCFICH Decoding

Selects the decoding type of the PCFICH. It specifies how much coding to undo before showing the bits from PCFICH on the Decoded Symbol Table. See 3GPP TS 36.212, Section 5.3.4 for a diagram of the coding operations performed to PCFICH.

The following is a list of the available PCFICH decoding type selections and the resulting bits:

- NONE – None, no bits for this channel will be shown on the Decoded Symbol Table.
- DESCrambled – Descrambled, 32 descrambled (channel coded) bits per subframe
- DECoded – Decoded, 2 decoded bits (CFI) per subframe

NOTE The PCFICH decoder is On when PCFICH Decoding is not set to None or when PDCCH Allocation Auto Detect is set to On.

Key Path:	Meas Setup, Decode, Decode Type
Mode:	LTE, LTETDD
Remote Command:	[:SENSE] :EVM:DLINK:DECode:PCFich NONE DESCrambled DECoded [:SENSE] :EVM:DLINK:DECode:PCFich?
Example:	EVM:DLIN:DEC:PCF NONE EVM:DLIN:DEC:PCF?
Notes:	Available when Direction is Downlink.
State Saved:	Saved in instrument state.
Range:	None Descrambled Decoded
Initial S/W Revision:	A.06.00
Help Map ID:	29308

PDCCH Decoding

Selects the decoding type of the PDCCH. It specifies how much coding to undo before showing the bits from PDCCH on the Decoded Symbol Table. See 3GPP TS 36.212, Section 5.3.1 for a diagram of the coding operations performed on PDCCH.

The following is a list of the available PDCCH decoding type selections and the resulting bits. N_{REG} is the number of resource element groups not allocated for PHICH or PCFICH in a subframe.

- NONE – None, no PDCCH bits will be shown in the Decoded Symbol Table.
- DEMapped – Demapped, $N_{REG} * 8$ demapped (interleaved) DCI format bits for each subframe

- **DIN**terleaved – Deinterleaved, $N_{REG} * 8$ deinterleaved (scrambled) DCI format bits for each subframe
- **DES**Crambled – Descrambled, $N_{REG} * 8$ descrambled (rate-matched) bits for each subframe
- **DR**Matched – DeRateMatched, $\Sigma (8 + LEN_i)$ bits for each subframe
 Each set of bits for an active PDCCH transmission consists of an 8-bit length field (LEN_i) followed by the deratematched (channel coded) bits.
 LEN_i indicates the number of deratematched bits for the i th PDCCH transmission in a subframe and can be used to determine where a PDCCH ends and the next PDCCH begins in the Decoded Symbol Table.
 $LEN_i = 3 * (DCI \text{ Payload Length} + CRC \text{ Length})$
- **DE**Coded – Decoded, $\Sigma (8 + LEN_i)$ bits for each subframe
 Each set of bits for an active PDCCH transmission consists of an 8-bit length field (LEN_i), the decoded (DCI payload + CRC) bits, and the 16-bit CRC.
 LEN_i indicates the number of decoded bits (including CRC) for the i th PDCCH transmission in a subframe and can be used to determine where a PDCCH ends and the next PDCCH begins in the Decoded Symbol Table.
 $LEN_i = DCI \text{ Payload Length} + CRC \text{ Length}$

NOTE For both Deratematched and Decoded PDCCH bits, the analyzer auto-detects the number of active PDCCH transmitted within each subframe, n_{PDCCH} . The PDCCH decoder is On when RB Auto Detect Mode is set to Decode PDCCH or when PDCCH Decoding is not set to None.

Key Path:	Meas Setup, Decode, Decode Type
Mode:	LTE, LTETDD
Remote Command:	[:SENSe] :EVM:DLINk:DECode:PDCCh NONE DEMapped DINterleaved DESCrambled DRMatched DECode d [:SENSe] :EVM:DLINk:DECode:PDCCh?
Example:	EVM:DLIN:DEC:PDCC NONE EVM:DLIN:DEC:PDCC?
Notes:	Available when Direction is Downlink.
State Saved:	Saved in instrument state.
Range:	None Demapped Deinterleaved Descrambled DeRateMatched Decoded
Initial S/W Revision:	A.06.00
Help Map ID:	29309

PDSCH Decoding

Selects the decoding type of the PDSCH. It specifies how much coding to undo before showing the bits

LTE Modulation Analysis Measurement
Meas Setup (Measurement Setup)

from PDSCH on the Decoded Symbol Table. See 3GPP TS 36.212, Section 5.3.2 for a diagram of the coding operations performed on PDSCH. The following is a list of the available PDSCH decoding type selections and the resulting bits:

- NONE - None, no bits for this channel will be shown on the Decoded Symbol Table.
- DESCrambled - Descrambled, descrambled (rate-matched) bits for each subframe
- DRMatched – DeRateMatched, $\Sigma (16 + LEN_i)$ bits per subframe
 Each set of bits for a PDSCH transmission consists of an 16-bit length field (LEN_i) followed by the deratematched (channel coded) bits.
 LEN_i indicates the number of deratematched bits for the i^{th} PDSCH allocation in a subframe and can be used to determine where one set of deratematched bits ends and the next set begins in the Decoded Symbol Table.
 $LEN_i = 3 * (\text{Codeblock Length} + \text{CRC Length} + \text{Trellis Termination Bit Length})$ where Trellis Termination Bit Length = 4.
- DCBLock – Decoded CB, $\Sigma (16 + LEN_i)$ bits per subframe
 Each set of bits for a PDSCH codeblock consists of a 16-bit length field (LEN_i), the decoded codeblock bits, and a 24-bit CRC. When codeblock segmentation is not performed (Transport Block Size (TBS(n)) is less than 6144), the codeblock + CRC bits shown are the same as the transport block + CRC bits.
 LEN_i indicates the number of decoded bits (including CRC) for the i^{th} PDSCH codeblock in a subframe and can be used to determine where a set of codeblock bits ends and the next set begins in the Decoded Symbol Table.
- DTBBlock – Decoded TB, $\Sigma (\text{Transport Block Sizes} + 24)$ decoded transport block bits (including CRCs) per subframe
 Each set of bits consists of the decoded transport block bits followed by a 24-bit CRC. There is no LEN field for decoded transport block bits since the Transport Block Size for each PDSCH allocation is shown on the DL Decode Info table in the TBS(n) data result.

NOTE The PDSCH decoder is On when PDSCH Decoding is not set to None.

Key Path:	Meas Setup, Decode, Decode Type
Mode:	LTE, LTETDD
Remote Command:	[:SENSe] :EVM:DLINk:DECode:PDSCh NONE DESCrambled DRMatched DCBBlock DTBBlock [:SENSe] :EVM:DLINk:DECode:PDSCh?
Example:	EVM:DLIN:DEC:PDSC NONE EVM:DLIN:DEC:PDSC?
Dependencies:	Available when Direction is Downlink. Available when Detection is Auto and RB Auto Detect Mode is Decoded PDCCH.

State Saved:	Saved in instrument state.
Range:	None Descrambled DeRateMatched Decoded Code Block Decoded Tx Port Block
Initial S/W Revision:	A.06.00
Help Map ID:	29310

PUSCH Decoding

Selects the decoding type of the PUSCH. It determines the level of decoding for PUSCH bits shown in the Decoded Symbol Table.

- NONE - None, no decoding is performed on PUCCH bits. Mapped bits are shown in the Symbol Table.
- DESCrambled – Descrambled, descrambled (rate-matched) bits for each subframe are shown in the Decoded Symbol Table.
- DRMatched – DeRateMatched, $\Sigma (16 + LEN_i)$ bits per subframe.
Each set of bits for a PUSCH transmission consists of a 16-bit length field (LEN_i) followed by the deratematched (channel coded) bits for each codeblock.
 LEN_i indicates the number of deratematched bits for the i th codeblock in a subframe and can be used to determine where one set of deratematched codeblock bits ends and the next set begins in the Decoded Symbol Table.
 $LEN = 3 * (\text{Codeblock Length} + \text{CRC Length} + \text{Trellis Termination Bit Length})$ bits, where Codeblock Length is transmission dependent, CRC Length = 24 bits, and Trellis Termination Bit Length = 4 bits.
- DCBLoK – Decoded CB, $\Sigma (16 + LEN_i)$ bits per subframe.
Each set of bits for a PUSCH codeblock consists of a 16-bit length field (LEN), the decoded codeblock bits, and a 24-bit CRC. When codeblock segmentation is not performed (Transport Block Size (TBS(n)) is less than 6144), the codeblock + CRC bits shown are the same as the transport block + CRC bits.
 LEN_i indicates the number of decoded bits (including CRC) for the i th codeblock in a subframe and can be used to determine where a set of codeblock bits ends and the next set begins in the Decoded Symbol Table. $LEN_i = \text{Codeblock Length} + \text{CRC Length}$, where Codeblock Length is transmission dependent, and CRC Length = 24 bits.
- DTBLoK – Decoded TB, (Transport Block Size + 24) decoded transport block bits (including CRCs) per subframe.
The number of bits shown on the Decoded Symbol Table for a PUSCH channel allocation when PUSCH Bits is set to Decoded is equal to the sum of the Size metrics (HARQ Size, CQI/PMI Size, SR Size, etc.) plus the Transport Block Size (TBS) for the corresponding decoded PUSCH allocation listed in the UL Decode Info trace.

NOTE RNTI needs to be specified for a user allocation for PUSCH descrambling to be performed.

Key Path:	Meas Setup, Decode, Decode Type
-----------	---------------------------------

LTE Modulation Analysis Measurement
Meas Setup (Measurement Setup)

Mode:	LTE, LTETDD
Remote Command:	[:SENSE] :EVM:ULINK:DECode:PUSCh NONE DESCrambled DRMatched DCBLock DTBLock [:SENSE] :EVM:ULINK:DECode:PUSCh?
Example:	EVM:ULIN:DEC:PUSC NONE EVM:ULIN:DEC:PUSC?
Notes:	Available when Direction is Uplink. RNTI needs to be specified for a user allocation in the LTE Allocation Editor for PUSCH descrambling to be performed.
State Saved:	Saved in instrument state.
Range:	None Descrambled DeRatematched Decoded Code Block Decoded Tx Port Block
Initial S/W Revision:	A.06.00
Modified at S/W Revision:	A.10.00
Help Map ID:	29311

PUCCH Decoding

Selects the decoding type of the PUCCH. It determines how much coding to undo before showing the bits from PUCCH on the Decoded Symbol Table. See 3GPP TS 36.212, Section 5.2.3 for a diagram of the coding operations performed on PUCCH.

- NONE - None, raw PUCCH bits are mapped to resource element locations and shown in the Symbol Table. No PUCCH bits are shown in the Decoded Symbol Table.
- DESCrambled –Descrambled, descrambled (channel coded) bits for each subframe are shown on the Decoded Symbol Table.
- DECoded – Decoded, decoded bits for each subframe are shown in the Decoded Symbol Table.

NOTE For PUCCH Format 2/2a/2b, where both CQI/PMI and HARQ-ACK bits are jointly encoded, CQI/PMI information bits are listed first in a set of PUCCH bits, followed by HARQ-ACK information bits.

Key Path:	Meas Setup, Decode, Decode Type
Mode:	LTE, LTETDD
Remote Command:	[:SENSE] :EVM:ULINK:DECode:PUCCh NONE DESCrambled DECoded [:SENSE] :EVM:ULINK:DECode:PUCCh?
Example:	EVM:ULIN:DEC:PUCC NONE EVM:ULIN:DEC:PUCC?

Notes:	Available when Direction is Uplink.
State Saved:	Saved in instrument state.
Range:	None Descrambled Decoded
Initial S/W Revision:	A.10.00
Help Map ID:	40772

DCI Format Detection Include

Configures how the demodulator detects DCI formats 1, 1B, and 1D.

The analyzer uses the number of the PDCCH message payload bits to determine the DCI format used in a PDCCH. DCI formats 1B and 1D always have equal lengths. In some cases, message payload length for DCI format 1 can be the same length as 1B and 1D. To specify which DCI formats to look for, the analyzer provides the following settings for the DCI Formats 1, 1B, 1D Detection Include parameter.

- F1F1B - Formats 1 and 1B, the analyzer assumes format 1D is not present. When frame configuration enables format 1 to have the same length as format 1B, all DCI message payloads of this length are decoded as format 1. Otherwise, formats 1 and 1B are decoded separately.
- F1FD - Formats 1 and 1D, the analyzer assumes format 1B is not present. When frame configuration enables format 1 to have the same length as format 1D, all DCI message payloads of this length are decoded as format 1. Otherwise, formats 1 and 1D are decoded separately.
- F1 - Format 1 only, the analyzer assumes that formats 1B and 1D are not present. Format 1B or 1D message payloads are decoded as format 1 when possible format 1 message payload lengths include the format 1B/1D payload length. Otherwise, format 1B or 1D message payloads are ignored.
- F1B - Format 1B only, the analyzer assumes that formats 1 and 1D are not present. Any message payloads with the length of a format 1B payload are decoded as format 1B.
- F1D - Format 1D only, the analyzer assumes that formats 1 and 1B are not present. Any message payloads with the length of a format 1D payload are decoded as format 1D.

Key Path:	Meas Setup, Decode
Mode:	LTE, LTETDD
Remote Command:	[:SENSe] :EVM:DLINk:DECode:DFINclude F1F1B F1F1D F1 F1B F1D [:SENSe] :EVM:DLINk:DECode:DFINclude?
Example:	EVM:DLIN:DEC:DFIN F1F1B EVM:DLIN:DEC:DFIN?
Dependencies:	Available when Direction is Downlink.
Preset:	F1F1B
State Saved:	Saved in instrument state.
Range:	Formats1 and 1B Formats1 and 1D Format1 only Format1B only Format1D only

LTE Modulation Analysis Measurement
Meas Setup (Measurement Setup)

Initial S/W Revision:	A.06.00
Help Map ID:	29312

RNTI Range

Specifies the range of RNTI values for PDCCH transmissions that will be used as Random Access RNTIs (=RA-RNTI) or Transmit Power Control RNTIs (=TPC-RNTI) for decoding purposes. This parameter is available when Direction is Downlink.

Key Path:	Meas Setup, Decode
Initial S/W Revision:	A.06.00
Help Map ID:	29315

RA-RNTI Range Min Value

Sets the minimum value of the RA-RNTI range.

RA-RNTI Range specifies the range of RNTI values that are assumed to be RA-RNTIs when decoding PDCCH transmissions. This parameter is needed to unambiguously decode the contents of DCI Format 1A.

NOTE Zero is not a valid RA-RNTI value, but is used to indicate that there are no RA-RNTI contained in the LTE signal when both the Min and Max values are set to 0.

Any PDCCH whose CRC is scrambled with an RNTI that is not contained in either the RA-RNTI or TPC-RNTI ranges and cannot be determined to be a SI-RNTI or P-RNTI will be demodulated as a C-RNTI PDCCH.

Key Path:	Meas Setup, Decode, RNTI Range
Mode:	LTE, LTETDD
Remote Command:	[:SENSe] :EVM:DLINk:DECode:RNTI:MINimum:RA <integer> [:SENSe] :EVM:DLINk:DECode:RNTI:MINimum:RA?
Example:	EVM:DLIN:DEC:RNTI:MIN:RA 0 EVM:DLIN:DEC:RNTI:MIN:RA?
Notes:	The value should be less than or equal to RA-RNTI Range Max Value.
Dependencies:	Available when Direction is Downlink.
Preset:	0
State Saved:	Saved in instrument state.
Min:	0
Max:	60

Initial S/W Revision:	A.06.00
Help Map ID:	29316

RA-RNTI Range Max Value

Sets the maximum value of the RA-RNTI range.

RA-RNTI Range specifies the range of RNTI values that are assumed to be RA-RNTIs when decoding PDCCH transmissions. This parameter is needed to unambiguously decode the contents of DCI Format 1A.

NOTE Zero is not a valid RA-RNTI value, but is used to indicate that there are no RA-RNTI contained in the LTE signal when both the Min and Max values are set to 0.

Any PDCCH whose CRC is scrambled with an RNTI that is not contained in either the RA-RNTI or TPC-RNTI ranges and cannot be determined to be a SI-RNTI or P-RNTI will be demodulated as a C-RNTI PDCCH.

Key Path:	Meas Setup, Decode, RNTI Range
Mode:	LTE, LTETDD
Remote Command:	[:SENSE] :EVM:DLINk:DECode:RNTI:MAXimum:RA <integer> [:SENSE] :EVM:DLINk:DECode:RNTI:MAXimum:RA?
Example:	EVM:DLIN:DEC:RNTI:MAX:RA 0 EVM:DLIN:DEC:RNTI:MAX:RA?
Notes:	The value should be greater than or equal to the RA-RNTI Range Min Value.
Dependencies:	Available only when Direction is Downlink.
Preset:	0
State Saved:	Saved in instrument state.
Min:	0
Max:	60
Initial S/W Revision:	A.06.00
Help Map ID:	29319

TPC-RNTI Range Min Value

Sets the minimum value of the TPC-RNTI range.

TPC-RNTI Range specifies the range of RNTI values that are assumed to be TPC-RNTIs when decoding PDCCH transmissions.

DCI Formats 3 and 3A have the same message payload size as DCI Formats 0 and 1A. Any PDCCHs

LTE Modulation Analysis Measurement
Meas Setup (Measurement Setup)

with a RNTI falling within the specified TPC-RNTI Range will be decoded as DCI Format 3/3A transmit power control commands.

NOTE Any PDCCH whose CRC is scrambled with an RNTI that is not contained in either the RA-RNTI or TPC-RNTI ranges and cannot be determined to be a SI-RNTI or P-RNTI will be demodulated as a C-RNTI PDCCH.

Key Path:	Meas Setup, Decode, RNTI Range
Mode:	LTE, LTETDD
Remote Command:	[:SENSe] :EVM:DLINk:DECode:RNTI:MINimum:TPC <integer> [:SENSe] :EVM:DLINk:DECode:RNTI:MINimum:TPC?
Example:	EVM:DLIN:DEC:RNTI:MIN:TPC 0 EVM:DLIN:DEC:RNTI:MIN:TPC?
Notes:	The value should be less than or equal to TPC-RNTI Range Max Value.
Dependencies:	Available only when Direction is Downlink.
Preset:	0
State Saved:	Saved in instrument state.
Min:	0
Max:	65523
Initial S/W Revision:	A.06.00
Help Map ID:	29320

TPC-RNTI Range Max Value

Sets the maximum value of the TPC-RNTI range.

TPC-RNTI Range specifies the range of RNTI values that are assumed to be TPC-RNTIs when decoding PDCCH transmissions.

DCI Formats 3 and 3A have the same message payload size as DCI Formats 0 and 1A. Any PDCCHs with a RNTI falling within the specified TPC-RNTI Range will be decoded as DCI Format 3/3A transmit power control commands.

NOTE Any PDCCH whose CRC is scrambled with an RNTI that is not contained in either the RA-RNTI or TPC-RNTI ranges and cannot be determined to be a SI-RNTI or P-RNTI will be demodulated as a C-RNTI PDCCH.

Key Path:	Meas Setup, Decode, RNTI Range
Mode:	LTE, LTETDD

Remote Command:	[:SENSE] :EVM:DLINk:DECode:RNTI:MAXimum:TPC <integer> [:SENSE] :EVM:DLINk:DECode:RNTI:MAXimum:TPC?
Example:	EVM:DLIN:DEC:RNTI:MAX:TPC 0 EVM:DLIN:DEC:RNTI:MAX:TPC?
Notes:	The value should be greater than or equal to the TPC-RNTI Range Min Value.
Dependencies:	Available only when Direction is Downlink.
Preset:	0
State Saved:	Saved in instrument state.
Min:	0
Max:	65523
Initial S/W Revision:	A.06.00
Help Map ID:	29324

DCI Format 2 PMI Config

Displays a menu that enables you to specify the latest Precoding Matrix Indicator(s) (PMI) reported by the UE. The latest PMI report can be specified for PDSCH allocations using 1, 2, 3, or 4 layers. Valid PMI reports are shown in the table below:

Num. of Layers	2 Tx Antenna Ports	4 Tx Antenna Ports
1	0–3	0–15
2	0–1	0–15
3	n/a	0–15
4	n/a	0–15

When Format 2 DCI is used to specify PDSCH RB allocations for a user, the eNodeB can explicitly specify the precoding that was applied to the PDSCH allocations, or can indicate that the last PMI report from the UE was used. In the latter case, the LTE demodulator needs to know what PMI that the UE reported to be able to completely decode the contents of the DCI payload as well as decode the corresponding PDSCH user allocation.

More information about DCI Format 2 can be found in 3GPP TS 36.211, Section 5.3.3.1.5.

Key Path:	Meas Setup, Decode,
Mode:	LTE, LTETDD
Initial S/W Revision:	A.10.00
Help Map ID:	40773

Latest PMI Report on PUSCH using 1 Layer

Specifies the latest Precoding Matrix Indicator(s) (PMI) reported by the UE.

Key Path:	Meas Setup, Decode, DCI Format 2 PMI Config
Mode:	LTE, LTETDD
Remote Command:	[:SENSE] :EVM:DLINK:DECODE:DFTWO:PRONE <integer> [:SENSE] :EVM:DLINK:DECODE:DFTWO:PRONE?
Example:	EVM:DLIN:DEC:DFTW:PRON 1 EVM:DLIN:DEC:DFTW:PRON?
Dependencies:	Available when Direction is Downlink and Number of Tx Antenna is set to 2 or 4 Antennas. The number of valid PMI reports differs depending on the number of Tx Antenna. 2 Antennas: 0–3 4 Antennas: 0–15
Preset:	0
State Saved:	Saved in instrument state.
Min:	0
Max:	Depends on the number of Tx Antenna. 2 Antennas: 3 4 Antennas: 15
Initial S/W Revision:	A.10.00
Help Map ID:	40776

Latest PMI Report on PUSCH using 2 Layers

Specifies the latest Precoding Matrix Indicator(s) (PMI) reported by the UE.

Key Path:	Meas Setup, Decode, DCI Format 2 PMI Config
Mode:	LTE, LTETDD
Remote Command:	[:SENSE] :EVM:DLINK:DECODE:DFTWO:PRTWO <integer> [:SENSE] :EVM:DLINK:DECODE:DFTWO:PRTWO?
Example:	EVM:DLIN:DEC:DFTW:PRTW 1 EVM:DLIN:DEC:DFTW:PRTW?

Dependencies:	Available when Direction is Downlink and Number of Tx Antenna is set to 2 or 4 Antennas. The number of valid PMI reports differs depending on Number of Tx Antenna. 2 Antennas: 0–1 4 Antennas: 0–15
Preset:	0
State Saved:	Saved in instrument state.
Min:	0
Max:	Depends on the number of Tx Antenna. 2 Antennas: 1 4 Antennas: 15
Initial S/W Revision:	A.10.00
Help Map ID:	40777

Latest PMI Report on PUSCH using 3 Layers

Specifies the latest Precoding Matrix Indicator(s) (PMI) reported by the UE.

Key Path:	Meas Setup, Decode, DCI Format 2 PMI Config
Mode:	LTE, LTETDD
Remote Command:	[:SENSE] :EVM:DLINK:DECode:DFTWo:PRTHree <integer> [:SENSE] :EVM:DLINK:DECode:DFTWo:PRTHree?
Example:	EVM:DLIN:DEC:DFTW:PRTH 1 EVM:DLIN:DEC:DFTW:PRTH?
Dependencies:	Available when Direction is Downlink and Number of Tx Antenna is set to 4 Antennas. The number of valid PMI reports differs depending on Number of Tx Antenna.
Preset:	0
State Saved:	Saved in instrument state.
Min:	0
Max:	15
Initial S/W Revision:	A.10.00
Help Map ID:	40778

Latest PMI Report on PUSCH using 4 Layers

Specifies the latest Precoding Matrix Indicator(s) (PMI) reported by the UE.

Key Path:	Meas Setup, Decode, DCI Format 2 PMI Config
Mode:	LTE, LTETDD
Remote Command:	[:SENSE] :EVM:DLINk:DECode:DFTWo:PRFour <integer> [:SENSE] :EVM:DLINk:DECode:DFTWo:PRFour?
Example:	EVM:DLIN:DEC:DFTW:PRF 1 EVM:DLIN:DEC:DFTW:PRF?
Dependencies:	Available when Direction is Downlink and Number of Tx Antenna is set to 4 Antennas.
Preset:	0
State Saved:	Saved in instrument state.
Min:	0
Max:	15
Initial S/W Revision:	A.10.00
Help Map ID:	40780

PUSCH Decode Parameters

Displays a menu that enables you to configure decoding of HARQ-ACK, RI, and CQI/PMI information bits.

Available when Direction is Uplink.

Info Size parameter

Specifies the number of bits for all PUSCH transmissions for the selected uplink user allocation.

When AutoDet is selected for HARQ-ACK, RI, or CQI/PMI, the corresponding information bit size will be auto detected as far as possible.

The possible range of information bits is listed as follows:

- HARQ-ACK bits range: 0–11 bits
- RI bits range: 0–2 bits
- CQI-PMI bits range: 0–128 bits

TIP: For best demodulation performance, specify Info Size manually.

Offset Index parameter

Specifies the value of Ioffset for HARQ-ACK, RI, and CQI in the tables listed in 3GPP TS 36.213, Section 8.6.3.

The possible range of Offset Index values are as follows:

- HARQ-ACK bits range: 0–14 bits
- RI bits range: 0–12 bits
- CQI-PMI bits range: 2–15 bits

Key Path:	Meas Setup, Decode
Mode:	LTE, LTETDD
Initial S/W Revision:	A.10.00
Help Map ID:	40781

PUSCH HARQ-ACK

Displays a menu that enables you to set the information size and offset index of PUSCH HARQ ACK/NACK.

Key Path:	Meas Setup, Decode, PUSCH Decode Parameters
Mode:	LTE, LTETDD
Initial S/W Revision:	A.10.00
Help Map ID:	40782

PUSCH HARQ-ACK Info Size

Specifies the HARQ-ACK informatin size in bits.

When AutoDet is selected, information size will be auto detected as far as possible.

TIP: For the best demodulation performance, specify Info Size manually.

Key Path:	Meas Setup, Decode, PUSCH Decode Parameters, HARQ-ACK
Mode:	LTE, LTETDD
Remote Command:	[:SENSe] :EVM:ULINk:DECode:PUSCh:HARQ:ISIZe <integer> [:SENSe] :EVM:ULINk:DECode:PUSCh:HARQ:ISIZe? [:SENSe] :EVM:ULINk:DECode:PUSCh:HARQ:ISIZe:AUTO OFF ON 0 1 [:SENSe] :EVM:ULINk:DECode:PUSCh:HARQ:ISIZe:AUTO?
Example:	EVM:ULIN:DEC:PUSC:HARQ:ISIZ 0 EVM:ULIN:DEC:PUSC:HARQ:ISIZ? EVM:ULIN:DEC:PUSC:HARQ:ISIZ:AUTO 0 EVM:ULIN:DEC:PUSC:HARQ:ISIZ:AUTO?
Dependencies:	Available when Direction is Uplink and PUSCH HARQ-ACK Info Size Auto Detect is OFF.

LTE Modulation Analysis Measurement
Meas Setup (Measurement Setup)

Preset:	0 ON
State Saved:	Saved in instrument state.
Min:	0
Max:	11
Initial S/W Revision:	A.10.00
Help Map ID:	40790

PUSCH HARQ-ACK Offset Index

Specifies the value of I_{offset} for HARQ-ACK in the tables listed in 3GPP TS 36.213, Section 8.6.3.

Key Path:	Meas Setup, Decode, PUSCH Decode Parameters, HARQ-ACK
Mode:	LTE, LTETDD
Remote Command:	[:SENSE] :EVM:ULINK:DECode:PUSCh:HARQ:OFFSet <integer> [:SENSE] :EVM:ULINK:DECode:PUSCh:HARQ:OFFSet?
Example:	EVM:ULIN:DEC:PUSC:HARQ:OFFS 0 EVM:ULIN:DEC:PUSC:HARQ:OFFS?
Dependencies:	Available when Direction is Uplink.
Preset:	0
State Saved:	Saved in instrument state.
Min:	0
Max:	14
Initial S/W Revision:	A.10.00
Help Map ID:	40792

PUSCH RI

Displays a menu that enables you to set the information size and offset index of PUSCH Rank Indicator.

Key Path:	Meas Setup, Decode, PUSCH Decode Parameters
Mode:	LTE, LTETDD
Initial S/W Revision:	A.10.00
Help Map ID:	40794

PUSCH RI Info Size

Specifies the RI informatin size in bits.

When AutoDet is selected, information size will be auto detected as far as possible.

TIP: For the best demodulation performance, specify Info Size manually.

Key Path:	Meas Setup, Decode, PUSCH Decode Parameters, RI
Mode:	LTE, LTETDD
Remote Command:	[:SENSe] :EVM:ULINk:DECode:PUSCh:RI:ISIZe <integer> [:SENSe] :EVM:ULINk:DECode:PUSCh:RI:ISIZe? [:SENSe] :EVM:ULINk:DECode:PUSCh:RI:ISIZe:AUTO OFF ON 0 1 [:SENSe] :EVM:ULINk:DECode:PUSCh:RI:ISIZe:AUTO?
Example:	EVM:ULIN:DEC:PUSC:RI:ISIZ 0 EVM:ULIN:DEC:PUSC:RI:ISIZ? EVM:ULIN:DEC:PUSC:RI:ISIZ:AUTO 1 EVM:ULIN:DEC:PUSC:RI:ISIZ:AUTO?
Dependencies:	Available when Direction is Uplink and PUSCH RI Info Size Auto Detect is Off.
Preset:	0 ON
State Saved:	Saved in instrument state.
Min:	0
Max:	2
Initial S/W Revision:	A.10.00
Help Map ID:	40796

PUSCH RI Offset Index

Specifies the value of I_{offset} for RI in the tables listed in 3GPP TS 36.213, Section 8.6.3.

Key Path:	Meas Setup, Decode, PUSCH Decode Parameters, RI
Mode:	LTE, LTETDD
Remote Command:	[:SENSe] :EVM:ULINk:DECode:PUSCh:RI:OFFSet <integer> [:SENSe] :EVM:ULINk:DECode:PUSCh:RI:OFFSet?
Example:	EVM:ULIN:DEC:PUSC:RI:OFFS 1 EVM:ULIN:DEC:PUSC:RI:OFFS?
Dependencies:	Available when Direction is Uplink.
Preset:	0

LTE Modulation Analysis Measurement
Meas Setup (Measurement Setup)

State Saved:	Saved in instrument state.
Min:	0
Max:	12
Initial S/W Revision:	A.10.00
Help Map ID:	40798

PUSCH CQI/PMI

Displays a menu that enables you to set the information size and offset index of PUSCH Channel Quality & Precoding Matrix Indicator.

Key Path:	Meas Setup, Decode, PUSCH Decode Parameters
Mode:	LTE, LTETDD
Initial S/W Revision:	A.10.00
Help Map ID:	40800

PUSCH CQI/PMI Info Size

Specifies the CQI/PMI information size in bits.

When AutoDet is selected, information size will be auto detected as far as possible.

TIP: For the best demodulation performance, specify Info Size manually.

Key Path:	Meas Setup, Decode, PUSCH Decode Parameters, CQI/PMI
Mode:	LTE, LTETDD
Remote Command:	[:SENSe] :EVM:ULINk:DECode:PUSCh:CQI:ISIZe <integer> [:SENSe] :EVM:ULINk:DECode:PUSCh:CQI:ISIZe? [:SENSe] :EVM:ULINk:DECode:PUSCh:CQI:ISIZe:AUTO OFF ON 0 1 [:SENSe] :EVM:ULINk:DECode:PUSCh:CQI:ISIZe:AUTO?
Example:	EVM:ULIN:DEC:PUSC:CQI:ISIZ 1 EVM:ULIN:DEC:PUSC:CQI:ISIZ? EVM:ULIN:DEC:PUSC:CQI:ISIZ:AUTO OFF EVM:ULIN:DEC:PUSC:CQI:ISIZ:AUTO?
Dependencies:	Available when Direction is Uplink and PUSCH CQI/RI Info Size Auto Detect is Off.
Preset:	0 ON
State Saved:	Saved in instrument state.

Min:	0
Max:	128
Initial S/W Revision:	A.10.00
Help Map ID:	40802

PUSCH CQI/PMI Offset Index

Specifies the value of I_{offset} for CQI/PMI in the tables listed in 3GPP TS 36.213, Section 8.6.3.

Key Path:	Meas Setup, Decode, PUSCH Decode Parameters, CQI/PMI
Mode:	LTE, LTETDD
Remote Command:	[:SENSE] :EVM:ULINk:DECode:PUSCh:CQI:OFFSet <integer> [:SENSE] :EVM:ULINk:DECode:PUSCh:CQI:OFFSet?
Example:	EVM:ULIN:DEC:PUSC:CQI:OFFS 2 EVM:ULIN:DEC:PUSC:CQI:OFFS?
Preset:	2
State Saved:	Saved in instrument state.
Min:	2
Max:	15
Initial S/W Revision:	A.10.00
Help Map ID:	40806

PUCCH Decode Parameters

Displays a menu that enables you to configure decoding of HARQ-ACK and CQI/PMI information bits. The Info Size parameter specifies the number of bits for all PUCCH transmissions for the selected uplink user allocation.

Available when Direction is Uplink.

Info Size parameter

Specifies the number of bits for all PUCCH transmissions for the selected uplink user allocation.

When AutoDet is selected for HARQ-ACK or CQI/PMI, the corresponding information bit size will be auto detected as far as possible.

The possible range of information bits is listed as follows:

- HARQ-ACK bits range: 0–2 bits
- CQI-PMI bits range: 0–11 bits

LTE Modulation Analysis Measurement
Meas Setup (Measurement Setup)

TIP: For best demodulation performance, specify Info Size manually.

Key Path:	Meas Setup, Decode
Mode:	LTE, LTETDD
Initial S/W Revision:	A.10.00
Help Map ID:	40808

PUCCH HARQ-ACK

Displays a menu that enables you to set the of PUCCH HARQ ACK/NACK information size in bits.

Key Path:	Meas Setup, Decode, PUCCH Decode Parameters
Mode:	LTE, LTETDD
Initial S/W Revision:	A.10.00
Help Map ID:	40809

PUCCH HARQ-ACK Info Size

Specifies the HARQ-ACK information size in bits.

When AutoDet is selected, information size will be auto detected as far as possible.

TIP: For the best demodulation performance, specify Info Size manually.

Key Path:	Meas Setup, Decode, PUCCH Decode Parameters, HARQ-ACK
Mode:	LTE, LTETDD
Remote Command:	<pre>[:SENSe] :EVM:ULINK:DECode:PUCCh:HARQ:ISize <integer> [:SENSe] :EVM:ULINK:DECode:PUCCh:HARQ:ISize? [:SENSe] :EVM:ULINK:DECode:PUCCh:HARQ:ISize:AUTO OFF ON 0 1 [:SENSe] :EVM:ULINK:DECode:PUCCh:HARQ:ISize:AUTO?</pre>
Example:	<pre>EVM:ULIN:DEC:PUCC:HARQ:ISIZ 0 EVM:ULIN:DEC:PUCC:HARQ:ISIZ? EVM:ULIN:DEC:PUCC:HARQ:ISIZ:AUTO 0 EVM:ULIN:DEC:PUCC:HARQ:ISIZ:AUTO?</pre>
Dependencies:	Available when Direction is Uplink and PUCCH HARQ-ACK Info Size Auto Detect is Off.
Preset:	0 ON
State Saved:	Saved in instrument state.

Min:	0
Max:	2
Initial S/W Revision:	A.10.00
Help Map ID:	40810

PUCCH CQI/PMI

Displays a menu that enables you to set the Channel Quality & Precoding Matrix Indicator information size in bits.

Key Path:	Meas Setup, Decode, PUCCH Decode Parameters
Mode:	LTE, LTETDD
Initial S/W Revision:	A.10.00
Help Map ID:	40811

PUCCH CQI/PMI Info Size

Specifies the CQI/PMI information size in bits.

When AutoDet is selected, information size will be auto detected as far as possible.

TIP: For the best demodulation performance, specify Info Size manually.

Key Path:	Meas Setup, Decode, PUCCH Decode Parameters, CQI/PMI
Mode:	LTE, LTETDD
Remote Command:	[:SENSE] :EVM:ULINk:DECode:PUCCh:CQI:ISIZe <integer> [:SENSE] :EVM:ULINk:DECode:PUCCh:CQI:ISIZe? [:SENSE] :EVM:ULINk:DECode:PUCCh:CQI:ISIZe:AUTO OFF ON 0 1 [:SENSE] :EVM:ULINk:DECode:PUCCh:CQI:ISIZe:AUTO?
Example:	EVM:ULIN:DEC:PUCC:CQI:ISIZ 0 EVM:ULIN:DEC:PUCC:CQI:ISIZ? EVM:ULIN:DEC:PUCC:CQI:ISIZ:AUTO 0 EVM:ULIN:DEC:PUCC:CQI:ISIZ:AUTO?
Dependencies:	Available when Direction is Uplink and PUCCH HARQ-ACK Info Size Auto Detect is Off.
Preset:	0 ON
State Saved:	Saved in instrument state.
Min:	0

LTE Modulation Analysis Measurement
Meas Setup (Measurement Setup)

Max:	11
Initial S/W Revision:	A.10.00
Help Map ID:	40812

ACK/NACK Feedback Mode

Specifies whether the current HARQ ACK/NACK feedback mode is ACK/NACK multiplexing or ACK/NACK bundling. See 3GPP TS 36.212, Section 5.2.2.6 and 3GPP TS 36.213, Section 7.3 for more information.

Key Path:	Meas Setup, Decode
Mode:	LTETDD
Remote Command:	[:SENSE] :EVM:ULINK:DECode:ANFMode MULTiplexing BUNDling [:SENSE] :EVM:ULINK:DECode:ANFMode?
Example:	EVM:ULIN:DEC:ANFM MULT EVM:ULIN:DEC:ANFM?
Dependencies:	Available when Direction is Uplink.
Preset:	MULTiplexing
State Saved:	Saved in instrument state.
Range:	BUNDling MULTiplexing
Initial S/W Revision:	A.10.00
Help Map ID:	40813

Advanced

Displays a menu that enables you to select lesser used demodulation parameters for the current measurement. These settings are for advanced users and do not normally require adjustment for most common measurements.

Key Path:	Meas Setup, More
Mode:	LTE, LTETDD
Initial S/W Revision:	Prior to A.02.00
Modified at S/W Revision:	A.03.00
Help Map ID:	29232

Cyclic Prefix Length (Downlink)

Selects whether to automatically detect the Cyclic Prefix Length or specify the cyclic prefix length for Downlink.

- AUTO – Auto detect the Cyclic Prefix Length
- NORMal – Specify Cyclic Prefix Length as Normal (7.03125% the length of the symbol)
- EXTended – Specify Cyclic Prefix Length as Extended (25% the length of the symbol)

Cyclic Prefix Length specifies the cyclic prefix mode. The current Cyclic Prefix Length mode is displayed in the “[Error Summary](#)” on [page 1154](#) trace.

The Cyclic Prefix is added by the transmitter to each OFDM symbol by taking the last 7% (or 25% for extended Cyclic Prefix) of the OFDM symbol and appending it to the front. The addition of the Cyclic Prefix enables time for all the paths in a multipath environment to arrive at the receiver before the symbol is demodulated.

See “[Symbol Timing Adjust](#)” on [page 1111](#) for information about setting the location of the symbol FFT.

Key Path:	Meas Setup, Advanced
Mode:	LTE, LTETDD
Remote Command:	[:SENSE] :EVM:DLINk:SYNC:CPLength AUTO NORMal EXTended [:SENSE] :EVM:DLINk:SYNC:CPLength? [:SENSE] :EVM:DLINk:SYNC:CPLength:AUTO OFF ON 0 1 [:SENSE] :EVM:DLINk:SYNC:CPLength:AUTO?
Example:	EVM:DLIN:SYNC:CPL NORM EVM:DLIN:SYNC:CPL? EVM:DLIN:SYNC:CPL:AUTO 1 EVM:DLIN:SYNC:CPL:AUTO?
Couplings:	Coupled with Cyclic Prefix Length (Uplink).
Preset:	AUTO ON
State Saved:	Saved in instrument state.
Range:	Normal Extended
Initial S/W Revision:	Prior to A.02.00
Modified at S/W Revision:	A.03.00
Help Map ID:	29086

Auto

Selects Cyclic Prefix Length automatically.

Key Path:	Meas Setup, Advanced, Cyclic Prefix Length
Mode:	LTE, LTETDD
Initial S/W Revision:	Prior to A.02.00

LTE Modulation Analysis Measurement
Meas Setup (Measurement Setup)

Modified at S/W Revision:	A.03.00
Help Map ID:	29087

Normal

Selects Normal Cyclic Prefix Length.

Key Path:	Meas Setup, Advanced, Cyclic Prefix Length
Mode:	LTE, LTETDD
Initial S/W Revision:	Prior to A.02.00
Modified at S/W Revision:	A.03.00
Help Map ID:	29088

Extended

Selects Extended Cyclic Prefix Length.

Key Path:	Meas Setup, Advanced, Cyclic Prefix Length
Mode:	LTE, LTETDD
Initial S/W Revision:	Prior to A.02.00
Modified at S/W Revision:	A.03.00
Help Map ID:	29089

Cyclic Prefix Length (Uplink)

Selects whether to automatically detect the Cyclic Prefix Length or specify the cyclic prefix length for Uplink.

- AUTO – Auto detect the Cyclic Prefix Length
- NORMal – Specify Cyclic Prefix Length as Normal (7.03125% the length of the symbol)
- EXTended – Specify Cyclic Prefix Length as Extended (25% the length of the symbol)

Cyclic Prefix Length specifies the cyclic prefix mode. The current Cyclic Prefix Length mode is displayed in the “[Error Summary](#)” on [page 1154](#) trace.

The Cyclic Prefix is added by the transmitter to each OFDM symbol by taking the last 7% (or 25% for extended Cyclic Prefix) of the OFDM symbol and appending it to the front. The addition of the Cyclic Prefix enables time for all the paths in a multipath environment to arrive at the receiver before the symbol is demodulated.

See “[Symbol Timing Adjust](#)” on [page 1111](#) for information about setting the location of the symbol FFT.

Key Path:	Meas Setup, Advanced
Mode:	LTE, LTETDD

Remote Command:	[:SENSE] :EVM:ULINK:SYNC:CPLength AUTO NORMAl EXTended [:SENSE] :EVM:ULINK:SYNC:CPLength? [:SENSE] :EVM:ULINK:SYNC:CPLength:AUTO OFF ON 0 1 [:SENSE] :EVM:ULINK:SYNC:CPLength:AUTO?
Example:	EVM:ULIN:SYNC:CPL AUTO EVM:ULIN:SYNC:CPL? EVM:ULIN:SYNC:CPL:AUTO 1 EVM:ULIN:SYNC:CPL:AUTO?
Dependencies:	When Sync Type is set to PRACH, Auto softkey is grayed out.
Couplings:	Coupled with Cyclic Prefix Length (Downlink).
Preset:	AUTO ON
State Saved:	Saved in instrument state.
Range:	Normal Extended
Initial S/W Revision:	Prior to A.02.00
Modified at S/W Revision:	A.03.00
Help Map ID:	Use 29086

Auto

Selects Cyclic Prefix Length automatically.

Key Path:	Meas Setup, Advanced, Cyclic Prefix Length
Mode:	LTE, LTETDD
Initial S/W Revision:	Prior to A.02.00
Modified at S/W Revision:	A.03.00
Help Map ID:	Use 29087

Normal

Selects Normal Cyclic Prefix Length.

Key Path:	Meas Setup, Advanced, Cyclic Prefix Length
Mode:	LTE, LTETDD
Initial S/W Revision:	Prior to A.02.00
Modified at S/W Revision:	A.03.00
Help Map ID:	Use 29088

Extended

Selects Extended Cyclic Prefix Length.

Key Path:	Meas Setup, Advanced, Cyclic Prefix Length
Mode:	LTE, LTETDD
Initial S/W Revision:	Prior to A.02.00
Modified at S/W Revision:	A.03.00
Help Map ID:	Use 29089

Extended Freq Lock Range

Provides the ability to reduce the frequency lock range. When this parameter is on, the frequency lock range is two and a half times the subcarrier spacing or 37.5 kHz. When this parameter is off, it is reduced to one half the subcarrier spacing, or 7.5kHz, which enables faster processing time.

Key Path:	Meas Setup, Advanced
Mode:	LTE, LTETDD
Remote Command:	[:SENSe] :EVM:EXTended:FREQuency:LOCK:RANGe OFF ON 0 1 [:SENSe] :EVM:EXTended:FREQuency:LOCK:RANGe?
Example:	EVM:EXT:FREQ:LOCK:RANG OFF EVM:EXT:FREQ:LOCK:RANG?
Preset:	OFF
State Saved:	Saved in instrument state.
Initial S/W Revision:	Prior to A.02.00
Modified at S/W Revision:	A.03.00
Help Map ID:	29233

Equalizer Training

Displays a menu that enables you to set whether or not to equalize the signal.

Channel equalization only applies to phase and amplitude. For information about signal-level timing correction, see [“Sync Type” on page 765](#).

NOTE Small-scale deviations (slot-by-slot or symbol-by-symbol) from the equalization channel frequency response are compensated by EVM Minimization.

Downlink:

The channel frequency response is computed over the entire Result Length, and the resulting coefficients are shown in the Eq Chan Freq Resp trace.

- OFF - When Off is selected, no equalization will be applied to the signal.
- RS - When RS is selected, equalization will be performed using the frequency response calculated from the reference signal for the reference antenna path. The channel frequency response for subcarriers between reference signals will be linearly interpolated.
For downlink, the standard only specifies using the reference signal for equalization. However, the LTE demodulator can apply a RS+Data equalization for single-channel downlink signals.
- RSD - When RS+Data is selected, equalization will be performed using the frequency response calculated using the reference signal and the data subcarriers. RS+Data equalization is not supported for multi-antenna downlink signals (when number of input channels is greater than 1).

When including data (PDSCH) subcarriers in equalizer calculations:

1. The demodulator equalizes the signal using the reference signal and demodulates the data subcarrier values.
2. Using the demodulated signal, the demodulator calculates a reference LTE signal (shown in IQ Ref)
3. Then the demodulator calculates another equalizer channel frequency response by comparing all the measured PDSCH and RS subcarrier values with the corresponding reference subcarrier values
4. Finally, the channel frequency response including PDSCH is applied to the signal, the signal is demodulated, and the results of the demodulation are shown on the traces

A moving average can be applied to the RS subcarriers in frequency. For more information, see [“Moving Average Filter” on page 1109](#)

NOTE	To see the measured channel frequency response for the current Tx/Rx path, use the Eq Chan Freq Resp trace.
	To see the measured channel frequency responses for all Tx/Rx paths, use the MIMO Eq Chan Freq Resp trace.
	The Equalizer Training setting determines what subcarriers are used when the Tracking method of EVM Minimization is selected. See the “EVM Minimization” on page 1120 for more information.

Uplink:

Channel frequency responses are computed and equalization is applied on a slot-by-slot basis. These per-slot channel frequency responses are shown in the [“Eq Ch Freq Resp Per Slot” on page 1165](#) trace. The [“Eq Ch Frequency Response” on page 1164](#) trace however shows a single set of channel frequency response coefficients computed from the time data in the [“Search Time” on page 1144](#) trace (capture length defined by [“Result Length” on page 784](#)).

- OFF - When Off is selected, the channel frequency response will still be calculated from the DM-RS subcarriers but will not be applied to the signal.
- RS - When RS is selected, the signal will be equalized using the channel frequency response calculated using the DM-RS subcarriers in the signal.
- RSD - When RS+Data is selected, the LTE demodulator calculates the equalizer channel frequency response according to the standard using the DM-RS subcarriers and the DFT-spread (SC-FDMA)

LTE Modulation Analysis Measurement
Meas Setup (Measurement Setup)

subcarriers (PUSCH). The LTE standard specifies that an RS+Data equalization should be performed for uplink signals.

NOTE PRACH equalization is done differently from the other uplink channels' equalization. First, the channel frequency response is calculated for a PRACH transmission by comparing the received preamble sequence to the reference preamble sequence. Then, the channel frequency response is averaged to a single correction value and this correction is applied to all subcarriers in the PRACH preamble. Each PRACH transmission is equalized separately from the other PRACH transmissions.

PRACH equalization is done this way because if each PRACH subcarrier were corrected individually, the equalization will simply remove the error from the PRACH transmission (resulting in near zero EVM) since the channel frequency response will be calculated from the same subcarriers that were being equalized.

Key Path:	Meas Setup, Advanced
Mode:	LTE, LTETDD
Remote Command:	[:SENSE] :EVM:EQUalizer:TRaining OFF RS RSD [:SENSE] :EVM:EQUalizer:TRaining?
Example:	EVM:EQU:TRA RS EVM:EQU:TRA ?
Preset:	RS
State Saved:	Saved in instrument state.
Range:	None RS RS + Data
Initial S/W Revision:	Prior to A.02.00
Modified at S/W Revision:	A.03.00
Help Map ID:	29236

Off

Selects no Equalizer Training.

Key Path:	Meas Setup, Advanced, Equalizer Training
Mode:	LTE, LTETDD
Initial S/W Revision:	Prior to A.02.00
Modified at S/W Revision:	A.03.00
Help Map ID:	29237

RS

Selects RS Equalizer Training.

Key Path:	Meas Setup, Advanced, Equalizer Training
Mode:	LTE, LTETDD
Initial S/W Revision:	Prior to A.02.00
Modified at S/W Revision:	A.03.00
Help Map ID:	29238

RS + Data

Selects RS + Data Equalizer Training.

Key Path:	Meas Setup, Advanced, Equalizer Training
Mode:	LTE, LTETDD
Initial S/W Revision:	A.03.00
Help Map ID:	40847

Moving Average Filter

Sets the value and state of the Moving Avg Filter.

Moving Avg Filter specifies whether or not to perform a moving average (frequency smoothing) on the reference signals during equalization, as well as the number of RS subcarriers to use in each average.

When Equalizer Training is set to **RS**, a value of 5 RS means the value of an RS subcarrier is calculated as the average of the value of that subcarrier and the values of the next two and previous two RS subcarriers in frequency.

When Equalizer Training is set to **RS+Data**, data subcarriers (PDSCH) in between the RS subcarriers are included in the average. For example, a setting of 3 RS means that the value of an RS subcarrier will be taken as the average of the next and previous RS subcarrier in frequency and all data subcarriers that are in between the next and previous RS subcarriers.

For RS subcarrier locations that do not have enough RS subcarriers to one side or the other (those near the edge of the frequency spectrum), the average is taken over available reference signal subcarriers.

Key Path:	Meas Setup, Sync/Format Setup
Mode:	LTE, LTETDD
Remote Command:	[:SENSE]:EVM:EQAlizer:TRaining:MAFilter:LENGth <integer> [:SENSE]:EVM:EQAlizer:TRaining:MAFilter:LENGth? [:SENSE]:EVM:EQAlizer:TRaining:MAFilter OFF ON 0 1 [:SENSE]:EVM:EQAlizer:TRaining:MAFilter?

LTE Modulation Analysis Measurement
Meas Setup (Measurement Setup)

Example:	EVM:EQU:TRA:MAF:LENG 19 EVM:EQU:TRA:MAF:LENG? EVM:EQU:TRA:MAF ON EVM:EQU:TRA:MAF?
Notes:	This parameter will always clip to an odd number. Available when Direction is Downlink.
Preset:	19 ON
State Saved:	Saved in instrument state.
Min:	1
Max:	399
Initial S/W Revision:	Prior to A.02.00
Modified at S/W Revision:	A.03.00
Help Map ID:	30797

MIMO Channel Frequency Normalize

Selects normalized or non-normalized MIMO Ch Frequency Response trace data. Normalized trace data is scaled to show each MIMO channel antenna path frequency response trace centered around 0 db. For normalized traces, all MIMO Channel paths are individually normalized for magnitude, phase, and time offset. For non-normalized trace data, the trace data is not scaled or modified.

Key Path:	Meas Setup, Advanced, Equalizer Training
Mode:	LTE, LTETDD
Remote Command:	[:SENSe] :EVM:EQUalizer:TRAIning:MCFNnormalize OFF ON 0 1 [:SENSe] :EVM:EQUalizer:TRAIning:MCFNnormalize?
Example:	EVM:EQU:TRA:MCFN OFF EVM:EQU:TRA:MCFN?
Dependencies:	Available only when Direction is Downlink.
Preset:	ON
State Saved:	Saved in instrument state.
Range:	On Off
Initial S/W Revision:	A.06.00
Help Map ID:	29325

Equalizer Training Mode

Selects the equalization method. This key is available only when Direction is set to Uplink.

- ZFORcing – Use Zero-Forcing equalizer
- LSQuares – Use Least Squares equalizer

Key Path:	Meas Setup, Advanced
Mode:	LTE, LTETDD
Remote Command:	[:SENSe] :EVM:EQUalizer:TRAIning:MODE ZFORcing LSQuares [:SENSe] :EVM:EQUalizer:TRAIning:MODE?
Example:	EVM:EQU:TRA:MODE ZFOR EVM:EQU:TRA:MODE?
Dependencies:	Available only when Direction is Uplink. Disabled when Sync Type is PRACH.
Preset:	ZFORcing
State Saved:	Saved in instrument state.
Range:	Zero Forcing Least Squares
Initial S/W Revision:	A.06.00
Help Map ID:	29326

Symbol Timing Adjust

Sets the demodulator to equalize the signal (i.e., whether or not to compensate for measured channel frequency response).

Key Path:	Meas Setup, Advanced
Mode:	LTE, LTETDD
Remote Command:	[:SENSe] :EVM:SYMBol:TIMing:ADJust MAX MIN START END CENTer FFTSize [:SENSe] :EVM:SYMBol:TIMing:ADJust?
Example:	EVM:SYMB:TIM:ADJ MAX EVM:SYMB:TIM:ADJ?
Preset:	MAX
State Saved:	Saved in instrument state.
Range:	Max of EVM Win Start/End Min of EVM Win Start/End EVM Window Start EVM Window End EVM Window Center %FFT Size
Initial S/W Revision:	Prior to A.02.00

LTE Modulation Analysis Measurement
Meas Setup (Measurement Setup)

Modified at S/W Revision:	A.03.00
Help Map ID:	29348

Max of EVM Window Start/End

Selects Max of EVM Window Start/End for Symbol Timing Adjust . When Max of EVM Window Start / End selected, the EVM for each subcarrier comes from the data set determined in the following manner: For each OFDM symbol, two FFTs are taken to determine the values of the subcarriers. The first FFT is taken starting at the beginning of the EVM Window. The second is taken starting at the end of the EVM Window. Two sets of EVMs are calculated for the subcarriers, one from each FFT. Then an RMS average is taken over each set. The set with the highest RMS average EVM is then chosen as the set to use in EVM and demodulation results.

Key Path:	Meas Setup, Advanced, Symbol Timing Adjust
Mode:	LTE, LTETDD
Initial S/W Revision:	Prior to A.02.00
Modified at S/W Revision:	A.03.00
Help Map ID:	30798

Min of EVM in Start/End

Selects Min of EVM Window Start/End for Symbol Timing Adjust. When Min of EVM Window Start / End is selected, the EVM for each subcarrier comes from the data set determined in the following manner: For each OFDM symbol, two FFTs are taken to determine the values of the subcarriers. The first FFT is taken starting at the beginning of the EVM Window. The second is taken starting at the end of the EVM Window. Two sets of EVMs are calculated for the subcarriers, one from each FFT. Then an RMS average is taken over each set. The set with the highest RMS average EVM is then chosen as the set to use in EVM and demodulation results.

Key Path:	Meas Setup, Advanced, Symbol Timing Adjust
Mode:	LTE, LTETDD
Initial S/W Revision:	Prior to A.02.00
Modified at S/W Revision:	A.03.00
Help Map ID:	30799

EVM Window Start

Selects EVM Window Start for Symbol Timing Adjust .

Key Path:	Meas Setup, Advanced, Symbol Timing Adjust
Mode:	LTE, LTETDD
Initial S/W Revision:	Prior to A.02.00

Modified at S/W Revision:	A.03.00
Help Map ID:	30800

EVM Window End

Selects EVM Window Stop for Symbol Timing Adjust.

Key Path:	Meas Setup, Advanced, Symbol Timing Adjust
Mode:	LTE, LTETDD
Initial S/W Revision:	Prior to A.02.00
Modified at S/W Revision:	A.03.00
Help Map ID:	30801

EVM Window Center

Selects EVM Window Center for Symbol Timing Adjust.

Key Path:	Meas Setup, Advanced, Symbol Timing Adjust
Mode:	LTE, LTETDD
Initial S/W Revision:	Prior to A.02.00
Modified at S/W Revision:	A.03.00
Help Map ID:	30802

% FFT Size

Selects %FFT Size for Symbol Timing Adjust which enables you to enter the value. When % of FFT Size is selected, the symbol FFT used for EVM and demodulation results begins at the specified location. A maximum value of 0% begins the FFT at the end of the CP (beginning of the Symbol). The minimum value of -7.125% (or -25% for extended CP Length) begins the FFT at the beginning of the cyclic prefix. Setting the value to 0% will provide the maximum amount of time for all the paths in a multipath environment to arrive at the receiver before the symbol FFT is taken.

Key Path:	Meas Setup, Advanced, Symbol Timing Adjust
Mode:	LTE, LTETDD
Remote Command:	[:SENSE] :EVM:SYMBOL:TIMing:ADJust:USER <percent> [:SENSE] :EVM:SYMBOL:TIMing:ADJust:USER?
Example:	EVM:SYMB:TIM:ADJ:USER -3.125 EVM:SYMB:TIM:ADJ:USER?
Preset:	-3.125 %
State Saved:	Saved in instrument state.

LTE Modulation Analysis Measurement
Meas Setup (Measurement Setup)

Min:	-25 %
Max:	0 %
Initial S/W Revision:	Prior to A.02.00
Modified at S/W Revision:	A.03.00
Help Map ID:	30803

EVM Window Length

Selects the EVM Window Length.

EVM Window Length specifies the length of the window used for EVM calculations. The EVM window is centered in the cyclic prefix.

A value of 3GPP will set EVM Window Length according to the LTE standard for EVM measurements. A Custom EVM window length can also be specified in the range of 1–512 samples. A value of 512 samples corresponds to the entire CP length for Extended CP on a 20 MHz signal.

The standard states that the EVM for an LTE signal's subcarriers should be taken from the higher of the two EVM RMS averages calculated from the FFTs taken from the start and from the end of the EVM window. For example, an EVM Window Length of 3 samples means that two FFTs will be taken, one on either sample adjacent to the center sample of the CP. The EVMs for the subcarriers will come from the FFT with the higher EVM RMS average. However, the location of the symbol FFT used for EVM calculations can be set specifically using the Symbol Timing Adjust parameter.

NOTE A value of 1 sample will cause the EVM to be measured from an FFT taken from the center of the cyclic prefix, since any other FFTs will just be taken over the same sample points.

 EVM Window Length does not apply when Symbol Timing Adjust is set to % of FFT Size or EVM Window Center since these settings cause only one FFT to be taken starting from the specified location within the cyclic prefix regardless of the EVM Window Length setting.

Key Path:	Meas Setup, Advanced
Mode:	LTE, LTETDD
Remote Command:	[:SENSe] :EVM:WINDow:LENGth GPP CUSTom [:SENSe] :EVM:WINDow:LENGth?
Example:	EVM:WIND:LENG GPP EVM:WIND:LENG?
Preset:	GPP
State Saved:	Saved in instrument state.
Range:	RS None

Initial S/W Revision:	Prior to A.02.00
Modified at S/W Revision:	A.03.00
Help Map ID:	30804

3GPP

Selects 3GPP for EVM Window Length.

Key Path:	Meas Setup, Advanced, EVM Window Length
Mode:	LTE, LTETDD
Initial S/W Revision:	Prior to A.02.00
Modified at S/W Revision:	A.03.00
Help Map ID:	30805

Custom

Selects Custom for EVM Window Length, which enables you to enter the value. The value used is EVM Window Length Custom.

Key Path:	Meas Setup, Advanced, EVM Window Length
Mode:	LTE, LTETDD
Initial S/W Revision:	Prior to A.02.00
Modified at S/W Revision:	A.03.00
Help Map ID:	30806

EVM Window Length Custom

Sets the EVM Window Length. This key is available only when EVM Window Length is set to Custom

Key Path:	Meas Setup, Advanced, EVM Window Length, Custom
Mode:	LTE, LTETDD
Remote Command:	[:SENSe] :EVM:WINDow:LENGth:CUSTom <int> [:SENSe] :EVM:WINDow:LENGth:CUSTom?
Example:	EVM:WIND:LENG:CUST 1 EVM:WIND:LENG:CUST?
Preset:	32
State Saved:	Saved in instrument state.
Min:	1

LTE Modulation Analysis Measurement
Meas Setup (Measurement Setup)

Max:	The max value differs depending on the Sync Type (Uplink) and BW the user selected. When Sync Type (Uplink) is set to PRACH; 1.4 MHz -> 1314 3 MHz -> 2628 5 MHz -> 5256 10 MHz -> 10512 15 MHz -> 15768 20 MHz -> 21024 When Sync Type (Uplink) is set to other than PRACH; 1.4 MHz -> 32 3 MHz -> 64 5 MHz -> 128 10 MHz -> 256 15 MHz -> 384 20 MHz -> 512
Initial S/W Revision:	Prior to A.02.00
Modified at S/W Revision:	A.03.00, A.06.00
Help Map ID:	30815

Result Format

Displays a menu of keys that enables you to set the result format.

Key Path:	Meas Setup, Advanced
Mode:	LTE, LTETDD
Initial S/W Revision:	A.06.00
Help Map ID:	29327

Report EVM in dB

Switches the unit of EVM reporting between percentage and dB.

When set to ON, EVM is reported in dB on all traces.

When set to Off, EVM is reported in %rms according to the LTE standard.

The reference for EVM calculation in both cases is the ideal IQ points that are displayed on the IQ Ref and IQ Ref Time traces.

Key Path:	Meas Setup, Advanced, Result Format
-----------	--

Mode:	LTE, LTETDD
Remote Command:	[:SENSE] :EVM:REPort :DB OFF ON 0 1 [:SENSE] :EVM:REPort :DB?
Example:	EVM:REP:DB OFF EVM:REP:DB?
Preset:	OFF
State Saved:	Saved in instrument state.
Initial S/W Revision:	Prior to A.02.00
Modified at S/W Revision:	A.03.00
Help Map ID:	29234

Report Relative Power Levels

Switches the unit of Power reporting between in Absolute (dBm) and relative (dB).

The following traces are affected by this parameter:

- Error Vector Spectrum
- Error Vector Time
- IQ Freq Meas
- IQ Freq Ref
- IQ Meas
- IQ Meas Time
- IQ Ref
- IQ Ref Time
- RB Error Mag Spectrum
- RB Error Mag Time
- RB Power Spectrum
- RB Power Time
- RMS Error Vector Spectrum
- RMS Error Vector Time

The only summary table affected by this parameter is the Frame Summary table. The channel power will be reported in dB when this parameter is selected and in dBm when this parameter is cleared. The power values reported on Error Summary and MIMO Info Table are not affected by this parameter.

Key Path:	Meas Setup, Advanced, Result Format
Mode:	LTE, LTETDD

LTE Modulation Analysis Measurement
Meas Setup (Measurement Setup)

Remote Command:	[:SENSe] :EVM:REPort:POWer:RELative OFF ON 0 1 [:SENSe] :EVM:REPort:POWer:RELative?
Example:	EVM:REP:POW:REL OFF EVM:REP:POW:REL?
Preset:	ON
State Saved:	Saved in instrument state.
Initial S/W Revision:	A.03.00
Help Map ID:	40848

Power Boost Normalize

Determines if Power Boost Normalize is used.

When Power Boost Normalize is enabled, results displayed on IQ traces will be normalized by the power level (set for each channel in the LTE Allocation Editor) or power boost (in Downlink Control Channel Properties) settings of the corresponding channels so that each channel's average power is 0 dB.

Key Path:	Meas Setup, Advanced, Result Format
Mode:	LTE, LTETDD
Remote Command:	[:SENSe] :EVM:POWer:BOOSt:NORMalize OFF ON 0 1 [:SENSe] :EVM:POWer:BOOSt:NORMalize?
Example:	EVM:POW:BOOS:NORM OFF EVM:POW:BOOS:NORM?
Preset:	ON
State Saved:	Saved in instrument state.
Initial S/W Revision:	Prior to A.02.00
Modified at S/W Revision:	A.03.00
Help Map ID:	30807

Time Scale Factor

Sets Time Scale Factor.

Time Scale Factor sets the value by which to scale the bandwidth and time lengths of the measured signal. This setting can be used to compensate for mistuned crystals or to enable demodulation of signals at a lower rate, such as half rate or 1/10 rate.

Key Path:	Meas Setup, Advanced, More
Mode:	LTE, LTETDD

Remote Command:	[:SENSe] :EVM:TIME:SCALe:FACTor <value> [:SENSe] :EVM:TIME:SCALe:FACTor?
Example:	EVM:TIME:SCAL:FACT 1 EVM:TIME:SCAL:FACT?
Preset:	1
State Saved:	Saved in instrument state.
Min:	0.0625
Max:	16
Initial S/W Revision:	Prior to A.02.00
Modified at S/W Revision:	A.03.00
Help Map ID:	29245

Multi Carrier Filter

Specifies whether or not to apply a filter to the received LTE signal to filter out adjacent carriers.

When other carriers are expected to be adjacent to the LTE carrier of interest, this multi-carrier filter can be used to filter out the unwanted carrier and minimize leakage into the LTE carrier of interest.

Key Path:	Meas Setup, Advanced
Mode:	LTE, LTETDD
Remote Command:	[:SENSe] :EVM:MCFilter:STATe OFF ON 0 1 [:SENSe] :EVM:MCFilter:STATe?
Example:	EVM:MCF:STAT ON EVM:MCF:STAT?
Preset:	OFF
State Saved:	Saved in instrument state.
Range:	On Off
Initial S/W Revision:	A.06.00
Help Map ID:	29328

Phase Noise Optimization

The Phase Noise Optimization setting affects the phase noise distribution on the analyzer's LO.

Key Path:	Meas Setup, Advanced
Mode:	LTE, LTETDD

LTE Modulation Analysis Measurement
Meas Setup (Measurement Setup)

Remote Command:	[:SENSe] :EVM:FREQuency:SYNTHeSis[:STATe] 1 2 [:SENSe] :EVM:FREQuency:SYNTHeSis[:STATe] ?
Example:	EVM:FREQ:SYNT 1 EVM:FREQ:SYNT?
Notes:	Parameter key: 1 - Best Close-in 2 - Best Wide-offset
Preset:	1
State Saved:	Saved in instrument state.
Initial S/W Revision:	A.03.00
Help Map ID:	40849

Best Close-in Noise

Selects Best Close-in Noise for the Phase Noise Optimization.

Key Path:	Meas Setup, Advanced, PhNoise Opt
Mode:	LTE, LTETDD
Initial S/W Revision:	A.03.00
Help Map ID:	40850

Best Wide-offset Noise

Selects Best Wide-offset Noise for the Phase Noise Optimization.

Key Path:	Meas Setup, Advanced, PhNoise Opt
Mode:	LTE, LTETDD
Initial S/W Revision:	A.03.00
Help Map ID:	40851

EVM Minimization

Selects whether or not EVM Minimization algorithm will be applied. EVM Minimization uses the reference signal to correct the signal.

- OFF - Disable EVM Minimization
- GPP – 3GPP EVM minimization, the demodulator calculates timing, frequency/phase and IQ offset corrections using the reference signal and the data subcarriers as defined in Section F.3.1 of 36.141 for DL and Section E.3.1 of 36.521 for UL. For downlink, the data subcarriers are from PDSCH, and for uplink the data subcarriers are from PUSCH and PUCCH.
The demodulator applies the corrections on a slot-by-slot basis for uplink, or on a

subframe-by-subframe basis for downlink, as defined by the LTE standard.

- **TRACking** - Tracking, the demodulator applies corrections on a symbol-by-symbol basis and the Equalizer Training parameter determines whether or not data subcarriers are included in calculating corrections. When Equalizer Training is set to RS+Data, EVM Minimization Tracking is performed using the reference signal and the PDSCH data subcarriers. When Equalizer Training is set to RS or Off, EVM Minimization Tracking is performed using only the reference signal.

Reference signal subcarriers are transmitted periodically in time and frequency. The demodulator compares the reference signals with the expected data sequence and computes an error, or correction value, that can be used to track phase, amplitude, and timing at the symbol level when Tracking is selected and at the slot or subframe level when 3GPP is selected. For subcarriers that do not have a corresponding reference subcarrier to compare to, the correction value is calculated by linearly interpolating between RS (and PDSCH, when Equalizer Training is set to RS+Data) subcarrier corrections.

When corrections are averaged and applied to a slot or subframe, the same correction is applied to each symbol in the slot or subframe.

There are four corrections that can be applied to the signal to minimize the EVM: Amplitude, Frequency/Phase, Timing, and IQ Offset (IQ Offset is only for Uplink). See [“EVM Minimization Items” on page 1121](#) Items for more details.

Key Path:	Meas Setup, Advanced
Mode:	LTE, LTETDD
Remote Command:	[:SENSE] :EVM:EVMMinimize OFF GPP TRACking [:SENSE] :EVM:EVMMinimize?
Example:	EVM:EVMM OFF EVM:EVMM?
Dependencies:	3GPP is available only when Number of Tx Antenna is set to 1 Antenna.
Preset:	3GPP
State Saved:	Saved in instrument state.
Range:	Off 3GPP Tracking
Initial S/W Revision:	A.03.00
Help Map ID:	40852

EVM Minimization Items

Four types of corrections are available. They are calculated by comparing the measured reference signal to the ideal reference signal:

- **Amplitude** - When selected, the average reference signal amplitude error will be used to correct the amplitudes of the subcarriers.
- **Frequency/Phase** - When selected, the average reference signal phase difference will be used to adjust subcarrier phase.

LTE Modulation Analysis Measurement
Meas Setup (Measurement Setup)

- Timing - When selected, the average slope (average rate of change) of the RS phase in the frequency domain is used to correct the timing.
- IQ Offset (uplink, 3GPP only) - When selected, any IQ offset is compensated for on a slot-by-slot basis. This type of EVM minimization is only available when 3GPP is selected and the direction is uplink.
- IQ Imbalance - When selected, IQ gain, Quadrature error and Timing Skew are compensated. EVM result is minimized to exclude those IQ errors.

The CEVM measurement in the LTE FDD/TDD & MSR modes supports IQ Imbalance at A11.00. The Modulation Analysis measurement in the LTE FDD/TDD modes does not support IQ Imbalance.

For uplink, both equalization and 3GPP EVM Minimization occur on a slot-by-slot basis, while for downlink, equalization occurs over the entire Measurement Interval and 3GPP EVM Minimization occurs on a subframe-by-subframe basis.

Key Path:	Meas Setup, Advanced
Mode:	LTE, LTETDD
Initial S/W Revision:	A.03.00
Modified at S/W Revision:	A.11.00
Help Map ID:	29112

EVM Minimization by Timing

Selects whether or not Timing will be used for EVM minimization algorithm.

Key Path:	Meas Setup, Advanced, EVM Minimization Items
Mode:	LTE, LTETDD
Remote Command:	[:SENSe] :EVM:EVMMinimize:TIMing OFF ON 0 1 [:SENSe] :EVM:EVMMinimize:TIMing?
Example:	EVM:EVMM:TIM OFF EVM:EVMM:TIM?
Dependencies:	Enabled when EVM minimization is set to ON.
Preset:	ON
State Saved:	Saved in instrument state.
Backwards Compatibility SCPI:	[:SENSe] :EVM:PILot:TRACk:TIMing
Initial S/W Revision:	A.03.00
Modified at S/W Revision:	A.06.00
Help Map ID:	40853

EVM Minimization by Frequency/Phase

Selects whether or not Frequency/Phase will be used for EVM minimization algorithm.

Key Path:	Meas Setup, Advanced, EVM Minimization Items
Mode:	LTE, LTETDD
Remote Command:	[:SENSe] :EVM:EVMMinimize:FREQuency OFF ON 0 1 [:SENSe] :EVM:EVMMinimize:FREQuency?
Example:	EVM:EVMM:FREQ OFF EVM:EVMM:FREQ?
Dependencies:	Enabled when EVM minimization is set to ON
Preset:	ON
State Saved:	Saved in instrument state.
Backwards Compatibility SCPI:	[:SENSe] :EVM:PILot:TRACk:PHASe
Initial S/W Revision:	A.03.00
Modified at S/W Revision:	A.06.00
Help Map ID:	40854

EVM Minimization by Amplitude

Selects whether or not Amplitude will be used for EVM minimization algorithm.

Key Path:	Meas Setup, Advanced, EVM Minimization Items
Mode:	LTE, LTETDD
Remote Command:	[:SENSe] :EVM:EVMMinimize:AMPLitude OFF ON 0 1 [:SENSe] :EVM:EVMMinimize:AMPLitude?
Example:	EVM:EVMM:AMPL OFF EVM:EVMM:AMPL?
Dependencies:	Enabled when EVM minimization is set to ON
Preset:	ON
State Saved:	Saved in instrument state.
Backwards Compatibility SCPI:	[:SENSe] :EVM:PILot:TRACk:AMPLitude
Initial S/W Revision:	A.03.00
Modified at S/W Revision:	A.06.00
Help Map ID:	40855

EVM Minimization by IQ Offset

Selects whether or not IQ Offset will be used for EVM minimization algorithm.

Key Path:	Meas Setup, Advanced, EVM Minimization Items
Mode:	LTE, LTETDD
Remote Command:	[:SENSe] :EVM:EVMMinimize:IQOffset OFF ON 0 1 [:SENSe] :EVM:EVMMinimize:IQOffset?
Example:	EVM:EVMM:IQOF OFF EVM:EVMM:IQOF?
Dependencies:	Enabled when EVM minimization is set to ON and Direction is Uplink.
Preset:	ON
State Saved:	Saved in instrument state.
Backwards Compatibility SCPI:	[:SENSe] :EVM:ULINK:SYNC:IQOComp
Initial S/W Revision:	A.03.00
Help Map ID:	40856

EVM Minimization by IQ Imbalance

Selects whether or not IQ Imbalance will be used for EVM minimization algorithm.

The CEVM measurement in the LTE FDD/TDD & MSR modes supports IQ Imbalance at A11.00.
 The Modulation Analysis measurement in the LTE FDD/TDD modes does not support IQ Imbalance.

Key Path:	Meas Setup, Advanced, EVM Minimization Items
Mode:	LTE, LTETDD
Remote Command:	[:SENSe] :EVM:EVMMinimize:IQIMbalance OFF ON 0 1 [:SENSe] :EVM:EVMMinimize:IQIMbalance?
Example:	EVM:EVMM:IQIM OFF EVM:EVMM:IQIM?
Dependencies:	Enabled when EVM minimization is not OFF.
Preset:	OFF
State Saved:	Saved in instrument state.
Initial S/W Revision:	A.11.00
Help Map ID:	40968

Exclude EVM Transient Time

Excludes the EVM results calculated from part of OFDM symbols during a PUSCH allocation change as

specified by the standard.

Key Path:	Meas Setup, Advanced
Mode:	LTE, LTETDD
Remote Command:	[:SENSe] :EVM:EETTime OFF ON 0 1 [:SENSe] :EVM:EETTime?
Example:	EVM:EETT ON EVM:EETT?
Notes:	Available when Direction is Uplink.
Preset:	OFF
State Saved:	Saved in instrument state.
Range:	On Off
Initial S/W Revision:	A.10.00
Help Map ID:	40868

Opposite Direction Active

Specifies whether or not the signal for opposite direction is present in the signal under test. For example, when downlink signal is under test, if there is also uplink signal present in uplink subframe, set the Opposite Direction Active to On will make the measurement more accurate with the knowledge of possible interference from uplink subframes.

Key Path:	Meas Setup, Advanced
Mode:	LTETDD
Remote Command:	[:SENSe] :EVM:ODActive OFF ON 0 1 [:SENSe] :EVM:ODActive?
Example:	EVM:ODAC ON EVM:ODAC?
Preset:	OFF
State Saved:	Saved in instrument state.
Range:	On Off
Initial S/W Revision:	A.10.00
Help Map ID:	40869

Antenna Element Spacing

Specifies the distance between the antennas in a linear antenna array. This parameter is used only for calculating the Antenna Beam Pattern trace, which shows the beam patterns applied to PDSCH user

LTE Modulation Analysis Measurement
Meas Setup (Measurement Setup)

allocations.

This parameter is specified in units of wavelengths of the Center Frequency.

NOTE

NOTE The LTE demodulator only supports vertical linear antenna arrays with uniform spacing.

Key Path:	Meas Setup, Advanced
Mode:	LTETDD
Remote Command:	[:SENSE] :EVM:DLINK:AESpacing <double> [:SENSE] :EVM:DLINK:AESpacing?
Example:	EVM:DLIN:AESP 0 EVM:DLIN:AESP?
Dependencies:	Available when Direction is Downlink.
Preset:	0.5
State Saved:	Saved in instrument state.
Min:	0
Max:	100
Initial S/W Revision:	A.10.00
Modified at S/W Revision:	A.11.00
Help Map ID:	40870

Number of Antenna Elements

Sets the number of antenna elements per antenna group.

Key Path:	Meas Setup, Advanced
Mode:	LTETDD
Remote Command:	[:SENSE] :EVM:DLINK:AENumber <integer> [:SENSE] :EVM:DLINK:AENumber?
Example:	EVM:DLIN:AEN 3 EVM:DLIN:AEN?
Dependencies:	Available when Direction is Downlink.
Preset:	4
State Saved:	Saved in instrument state.

Min:	2
Max:	8
Initial S/W Revision:	A.11.00
Help Map ID:	40960

Limits

Accesses a menu that enables you to set parameters required to calculate the limit for Per Slot Freq Resp trace. This key is available only when Direction is Uplink.

Key Path:	Meas Setup, Advanced
Initial S/W Revision:	A.11.00
Help Map ID:	40961

Spectrum Flatness Mask

Four parameters are required to calculate the limit for Per Slot Freq Resp trace, which can be used to perform the EVM equalizer spectrum flatness test defined in TS36–521 6.5.2.4

- Channel Condition – Specify under what environmental condition the test is performed. There two temperature conditions defined in TS36.101 Annex E, which are normal condition(+15×C to +35×C) and extreme condition(–10×C to +55×C).
- F_UL_Center – Specify the carrier frequency of the signal under test.
- F_UL_Low – Specify the lower frequency of the E-UTRA operating band defined in TS36–521–1 Table 5.2.1
- F_UL_High - Specify the upper frequency of the E-UTRA operating band defined in TS36–521–1 Table 5.2.1

This key is available only when Direction is Uplink.

Key Path:	Meas Setup, Advanced, Limit
Mode:	LTE, LTETDD
Initial S/W Revision:	A.11.00
Help Map ID:	40962

Channel Condition

Specifies under what condition the test is performed. This parameter will determine the minimum requirements for EVM equalizer spectrum flatness test.

Key Path:	Meas Setup, Advanced, Limit, Spectrum Flatness Mask
Mode:	LTE, LTETDD

LTE Modulation Analysis Measurement
Meas Setup (Measurement Setup)

Remote Command:	[:SENSe] :EVM:ULINk:FLATness:CHANnel:CONDition NORMal EXTReMe [:SENSe] :EVM:ULINk:FLATness:CHANnel:CONDition?
Example:	EVM:ULIN:FLAT:CHAN:COND NORM EVM:ULIN:FLAT:CHAN:COND?
Dependencies:	Available when Direction is uplink.
Preset:	NORMal
State Saved:	Saved in instrument state.
Range:	NORMal EXTReMe
Initial S/W Revision:	A.11.00
Help Map ID:	40963

F_UL_Center

Specifies the carrier frequency of signal under test.

Key Path:	Meas Setup, Advanced, Limit, Spectrum Flatness Mask
Remote Command:	[:SENSe] :EVM:ULINk:FREQuency:CENTer <freq> [:SENSe] :EVM:ULINk:FREQuency:CENTer?
Example:	EVM:ULIN:FREQ:CENT 1.95 GHz EVM:ULIN:FREQ:CENT?
Couplings:	The value is clipped to F_UL_Low or F_UL_High. If the value entered is greater than F_UL_High, it is set to the value of F_UL_High. If the value entered is lower than F_UL_Low, it is set to the value of F_UL_Low.
Preset:	1.95GHz
State Saved:	Saved in instrument state
Min:	Depends on F_UL_Low
Max:	Depends on F_UL_High
Default Unit:	Hz
Initial S/W Revision:	A.11.00
Help Map ID:	40964

F_UL_Low

Specifies the lower frequency of the E-UTRA operating band defined in TS36-521-1 Table 5.2.1.

Key Path:	Meas Setup, Advanced, Limit, Spectrum Flatness Mask
Remote Command:	[:SENSE] :EVM:ULINk:FREQuency:LOW <freq> [:SENSE] :EVM:ULINk:FREQuency:LOW?
Example:	EVM:ULIN:FREQ:LOW 1.92 GHz EVM:ULIN:FREQ:LOW?
Couplings:	If the value entered is greater than F_UL_High, F_UL_High is set to the value of F_UL_Low.
Preset:	1.92GHz
State Saved:	Saved in instrument state
Min:	0Hz
Max:	Depends on F_UL_High
Default Unit:	Hz
Initial S/W Revision:	A.11.00
Help Map ID:	40965

F_UL_High

Specifies the upper frequency of the E-UTRA operating band defined in TS36-521-1 Table 5.2.1

Key Path:	Meas Setup, Advanced, Limit, Spectrum Flatness Mask
Remote Command:	[:SENSE] :EVM:ULINk:FREQuency:HIGH <freq> [:SENSE] :EVM:ULINk:FREQuency:HIGH?
Example:	EVM:ULIN:FREQ:HIGH 1.98 GHz EVM:ULIN:FREQ:HIGH?
Couplings:	The value entered is lower than F_UL_Low, it is set to the F_UL_Low.
Preset:	1.98GHz
State Saved:	Saved in instrument state
Min:	Depends on F_UL_Low
Max:	5GHz
Default Unit:	Hz
Initial S/W Revision:	A.11.00
Help Map ID:	40966

LTE Modulation Analysis Measurement
Meas Setup (Measurement Setup)

Meas Preset

Immediately sets all measurement parameters to their Preset values. For more information, see [Preset @2300](#).

Key Path:	Meas Setup, More
Mode:	LTE, LTETDD
Initial S/W Revision:	Prior to A.02.00
Modified at S/W Revision:	A.03.00
Help Map ID:	29246

Mode

See [Mode@2670@i](#) for more information.

Key Path:	Front Panel
Help Map ID:	Use 2670

Mode Setup

See [Mode Setup@\(LTE\)28881,\(LTETDD\)4001](#) for more information.

Key Path:	Front Panel
Help Map ID:	Use 28881

Peak Search

See [Peak Search@25865@i](#) for more information.

Key Path:	Front Panel
Help Map ID:	Use 25865

Recall

See [Recall@\(LTE\)28892, \(LTETDD\)40472](#) for more information.

Key Path:	Front Panel
Help Map ID:	Use 28892

Restart

See [Restart@3307@i](#) for more information.

Key Path:	Front Panel
Help Map ID:	Use 3307

Save

See [Save@2600](#) for more information.

Key Path:	Front Panel
Help Map ID:	Use 2600

Single

See [Single \(Single Measurement/Sweep\)@3515@i](#) for more information.

Key Path:	Front Panel
Help Map ID:	Use 3515

Source (Internal)

See [Source \(Internal\) @35360@i](#) for a description of this function.

Key Path:	Front Panel
Help Map ID:	Use 35360

SPAN X Scale

See [Span X Scale@25890@i](#) for details

Key Path:	Front Panel
Help Map ID:	Use 25890

Span

See [Span@25771](#) for details. Note that in the LTE FDD/TDD mode, this key is available only for Modulation Analysis measurement.

Key Path:	SPAN X Scale
Help Map ID:	Use 25771

Full Span

See [Span@25772](#) for details. Note that in the LTE FDD/TDD mode, this key is available only for Modulation Analysis measurement.

Key Path:	SPAN X Scale
Help Map ID:	Use 25772

Sweep / Control

See [Sweep/Control@25856](#) for a description of this function.

Key Path:	Front Panel
Help Map ID:	Use 25856

Trace/Detector

Selects the results shown in the trace windows. There are no SCPI features unique to this measurement other than the selections under Data.

Displays a menu that enables you to select Trace/Detector parameters for Uplink signals.

See [Trace/Detector@25893](#) for more information.

Key Path:	Front Panel
Mode:	LTE, LTETDD
Initial S/W Revision:	Prior to A.02.00
Modified at S/W Revision:	A.03.00
Help Map ID:	Use 25893

Data

Displays a menu of Trace data choices for the selected trace.

The following table shows available trace data types. The SCPI command “:DISPlay:EVM:TRACe[1]|2|3|4:FEED <string>” can be used to configure the trace data. For example, the following command sets the first trace to Spectrum.

:DISP:EVM:TRAC1:FEED “Spectrum1”

Soft Key Name	SCPI string form	
Pre Demod		
Spectrum	"Spectrum1"	
Inst Spectrum	"Inst Spectrum1"	
Search Time	"Search Time1"	
Time	"Time1"	
Raw Main Time	"Raw Main Time1"	
Demod	<Uplink>	<Downlink>
IQ Meas	"Demod IQ Meas1"	"Layer IQ Meas1"
IQ Ref	"Demod IQ Ref1"	"Layer IQ Ref1"
IQ Meas Time	"Demod IQ Meas Time1"	"Layer IQ Meas Time1"
IQ Ref Time	"Demod IQ Ref Time1"	"Layer IQ Ref Time1"
IQ Freq Meas	"Demod IQ Freq Meas1"	"Layer IQ Freq Meas1"
IQ Freq Ref	"Demod IQ Freq Ref1"	"Layer IQ Freq Ref1"

LTE Modulation Analysis Measurement
Trace/Detector

Detected Allocations	"Demod Detected Allocations Time1"	"Layer Detected Allocations Time1"
Antenna Beam Pattern	N/A	"Demod Antenna Beam Pattern 1"
Demod Error	<Uplink>	<Downlink>
Error Vector Time	"Demod Error Vector Time1"	"Layer Error Vector Time1"
RMS Error Vector Time	"Demod RMS Error Vector Time1"	"Layer RMS Error Vector Time1"
Error Vector Spectrum	"Demod Error Vector Spectrum1"	"Layer Error Vector Spectrum1"
RMS Error Vector Spectrum	"Demod RMS Error Vector Spectrum1"	"Layer RMS Error Vector Spectrum"
Common Tracking Error	"Demod Common Tracking Error1"	
RB Error Mag Spectrum	"Demod RB Error Mag Spectrum1"	"Layer RB Error Mag Spectrum1"
RB Error Mag Time	"Demod RB Error Mag Time1"	"Layer RB Error Mag Time1"
RB Power Spectrum	"Demod RB Power Spectrum1"	"Layer RB Power Spectrum1"
RB Power Time	"Demod RB Power Time1"	"Layer RB Power Time1"
Freq Err Per Slot	"Demod Freq Err Per Slot1"	
IQ Offset Per Slot	"Demod IQ Offset Per Slot1"	
In-band Emissions.	"Demod In-band Emissions1"	
Tables		
Error Summary	"Demod Error Summary1"	
Frame Summary	"Demod Frame Summary1"	
Symbols (Uplink)	"Demod Symbol Table1"	
Symbols (Downlink)	"Layer Symbol Table1"	
Decoded Symbol Table (Uplink)	"Demod Decoded Symbol Table1"	
Decoded Symbol Table (Downlink)	"Demod CW0 Decoded Symbol Table1"	
DL Decode Info	"Demod DL Decode Info1"	
UL Decode Info	"Demod UL Decode Info1"	
UE-RS Weights	"Demod UE-specific RS Weights1"	
Response		
Eq Ch Freq Resp	"Demod Eq Chan Freq Resp1"	

Inst Eq Ch Freq Resp	"Demod Inst Eq Chan Freq Resp1"
Eq Ch Freq Resp Diff	"Demod Eq Chan Freq Resp Diff1"
Inst Eq Ch Freq Resp Diff	"Demod Inst Eq Chan Freq Resp Diff1"
Eq Impulse Response	"Demod Eq Impulse Response1"
Eq Ch Freq Resp Per Slot	"Demod Per Slot Eq Chan Freq Resp1"
MIMO	
Info Table	"MIMO Info Table1"
Ch Freq Resp	"MIMO Eq Chan Freq Resp1"
Ch Freq Resp Diff	"MIMO Eq Chan Freq Resp Diff1"
Eq Impulse Resp	"MIMO Eq Impulse Response1"
Common Track Error	"MIMO Common Tracking Error1"

For further details, see [Trace/Detector, Data@25798](#) and [Remote SCPI Commands and Data Queries@30187](#).

Key Path:	Trace/Detector
Mode:	LTE, LTETDD
Initial S/W Revision:	Prior to A.02.00
Modified at S/W Revision:	A.03.00
Help Map ID:	29250

Pre Demod

Displays the Trace Data choices that show pre-demodulation results. See “Data” on page 1141 for the corresponding SCPI command.

Key Path:	Trace/Detector, Data
Mode:	LTE, LTETDD
Initial S/W Revision:	Prior to A.02.00
Modified at S/W Revision:	A.03.00
Help Map ID:	29251

Spectrum

Averaged FFT of the Time waveform. See “Data” on page 1141 for the corresponding SCPI command.

Key Path:	Trace/Detector, Data, Pre Demod
-----------	--

Mode:	LTE, LTETDD
Initial S/W Revision:	Prior to A.02.00
Modified at S/W Revision:	A.03.00
Help Map ID:	29252

Inst Spectrum

FFT of the time waveform for the current measurement. “Inst” or Instantaneous refers to this result not being averaged like the Trace Data result. See [“Data” on page 1141](#) for the corresponding SCPI command.

Key Path:	Trace/Detector, Data, Pre Demod
Mode:	LTE, LTETDD
Initial S/W Revision:	Prior to A.02.00
Modified at S/W Revision:	A.03.00
Help Map ID:	29253

Search Time

Search Length long time record acquired for the current measurement. See [“Data” on page 1141](#) for the corresponding SCPI command.

Key Path:	Trace/Detector, Data, Pre Demod
Mode:	LTE, LTETDD
Initial S/W Revision:	Prior to A.02.00
Modified at S/W Revision:	A.03.00
Help Map ID:	29254

Time

Time data corresponding to the measurement interval used to compute demod results. See [“Data” on page 1141](#) for the corresponding SCPI command.

Key Path:	Trace/Detector, Data, Pre Demod
Mode:	LTE, LTETDD
Initial S/W Revision:	Prior to A.02.00
Modified at S/W Revision:	A.03.00
Help Map ID:	29255

Raw Main Time

Raw time record acquired for the current measurement. This data is unprocessed and includes additional points acquired for settling of the filters involved in subsequent processing, such as the demodulation filtering. See “Data” on page 1141 for the corresponding SCPI command.

Key Path:	Trace/Detector, Data, Pre Demod
Mode:	LTE, LTETDD
Initial S/W Revision:	Prior to A.02.00
Modified at S/W Revision:	A.03.00
Help Map ID:	29256

Statistical

Displays the Trace Data choices that show statistical results.

Key Path:	Trace/Detector, Data
Mode:	LTE, LTETDD
Initial S/W Revision:	Prior to A.02.00
Modified at S/W Revision:	A.03.00
Help Map ID:	29257

CCDF

The Complementary, Cumulative Density function (CCDF) for the selected input channel.

The analyzer plots CCDF using units of percent (%) for the y-axis and power (dB) for the x-axis. Power on the x-axis is relative to the signal average power.

Key Path:	Trace/Detector, Data, Statistical
Mode:	LTE, LTETDD
Initial S/W Revision:	Prior to A.02.00
Modified at S/W Revision:	A.03.00
Help Map ID:	29258

CDF

The Cumulative Density Function (CDF) for the selected input channel. CDF is computed by integrating the PDF (Probability Density Function).

Key Path:	Trace/Detector, Data, Statistical
Mode:	LTE, LTETDD

LTE Modulation Analysis Measurement
Trace/Detector

Initial S/W Revision:	Prior to A.02.00
Modified at S/W Revision:	A.03.00
Help Map ID:	29259

PDF

The Probability Density Function (PDF) for the selected input channel. PDF indicates the probability that a given level has occurred.

Key Path:	Trace/Detector, Data, Statistical
Mode:	LTE, LTETDD
Initial S/W Revision:	Prior to A.02.00
Modified at S/W Revision:	A.03.00
Help Map ID:	29260

Demod

Displays the Trace Data choices which show general demodulation results.

Key Path:	Trace/Detector, Data
Mode:	LTE, LTETDD
Initial S/W Revision:	Prior to A.02.00
Modified at S/W Revision:	A.03.00
Help Map ID:	29261

IQ Meas

IQ Meas is the measured IQ symbol values of the subcarriers. There is one complex value for each subcarrier for each symbol in the burst.

Normally this trace data is displayed as a constellation. The constellation display shows both data and pilot subcarriers, the pilots and data values are shown in different colors.

See “Data” on page 1141 for the corresponding SCPI command.

Key Path:	Trace/Detector, Data, Demod
Mode:	LTE, LTETDD
Initial S/W Revision:	Prior to A.02.00
Modified at S/W Revision:	A.03.00
Help Map ID:	30808

IQ Ref

IQ Ref is the reference (ideal) IQ values of the subcarriers. There is one complex value for each subcarrier for each symbol in the burst.

Normally this trace data is displayed as a constellation. The constellation shows both data and pilot subcarrier symbols, the pilots and data values are shown in different colors.

See “Data” on page 1141 for the corresponding SCPI command.

Key Path:	Trace/Detector, Data, Demod
Mode:	LTE, LTETDD
Initial S/W Revision:	Prior to A.02.00
Modified at S/W Revision:	A.03.00
Help Map ID:	29351

IQ Meas Time

IQ Meas and IQ Ref traces show signal levels as a function of subcarriers or samples/subcarriers. Signals levels on different OFDM symbols are shown as different points on the same vertical line corresponding to a subcarrier or subcarrier/sample. There is also value in showing these traces as a function of symbols on the X-axis. For each symbol, different subcarriers or samples will be shown as different points on the same vertical line.

See “Data” on page 1141 for the corresponding SCPI command.

Key Path:	Trace/Detector, Data, Demod
Mode:	LTE, LTETDD
Initial S/W Revision:	Prior to A.02.00
Modified at S/W Revision:	A.03.00
Help Map ID:	30809

IQ Ref Time

IQ Ref Time is similar to IQ Meas Time, except that the points plotted are the expected signal levels instead of the measured ones. See “Data” on page 1141 for the corresponding SCPI command.

Key Path:	Trace/Detector, Data, Demod
Mode:	LTE, LTETDD
Initial S/W Revision:	Prior to A.02.00
Modified at S/W Revision:	A.03.00
Help Map ID:	29264

IQ Freq Meas

IQ Freq Meas displays the measured IQ values (measured at the output of the FFT) of the subcarriers for each OFDM symbol point. This trace is identical to IQ Meas in downlink mode since IQ Meas also displays measured IQ values at the output of FFT. In uplink mode, while IQ Meas displays PUSCH values after despreading (IFFT), IQ Freq Meas continues to display PUSCH IQ values at the output of the FFT, which resembles a collection of random points concentrated around the origin. See “Data” on page 1141 for the corresponding SCPI command.

NOTE To view SC-FDMA (uplink PUSCH) signals in the time domain, use IQ Meas.

The data in IQ Freq Meas, which comes from the Time trace data as that data is passed through the demodulator, is a 2x2 matrix with frequency along one dimension and time along the other. In addition, each one of the points in the matrix is a complex value; therefore there are 4 total dimensions. The choice of trace format determines which two dimensions will be on the x-y plane, and which dimensions will be overlapped, averaged, or ignored. The relevant trace formats and their corresponding view of the data are described below.

Constellation, IQ - The I-Q plane is mapped to the x-y plane and each point contains both a subcarrier and a symbol-time reference. In other words, each point plotted on the complex plane came from a symbol transmitted on a specific subcarrier at a certain time.

LogMag, LinMag, Real, Imag, Wrapped Phase, Unwrapped Phase - Subcarriers are plotted along the x-axis. All the symbols that a subcarrier transmits have been plotted above the corresponding subcarrier tick on the x-axis, in the specified format (whether it be dB magnitude or the real value of the symbol point, etc.).

Key Path:	Trace/Detector, Data, Demod
Mode:	LTE, LTETDD
Initial S/W Revision:	A.02.00
Modified at S/W Revision:	A.03.00
Help Map ID:	30817

IQ Freq Ref

IQ Freq Ref displays the reference (demodulated) IQ values of the subcarriers for each OFDM symbol point at the output of the FFT. This trace is identical to IQ Ref in downlink mode. In uplink mode, this trace always displays OFDM reference IQ points (unlike IQ Ref, which displays reference PUSCH SC-FDMA IQ points after despreading (IFFT)). See “Data” on page 1141 for the corresponding SCPI command.

NOTE To view SC-FDMA (uplink PUSCH) signals in the time domain, use IQ Meas.

Key Path:	Trace/Detector, Data, Demod
Mode:	LTE, LTETDD

Initial S/W Revision:	A.02.00
Modified at S/W Revision:	A.03.00
Help Map ID:	30818

Detected Allocations

Detected Allocations displays the RB allocations detected by the measurement if “Auto Detect” is on, or the user-configured RB allocations if “Auto Detect” is off.

See “Data” on page 1141 for the corresponding SCPI command.

Key Path:	Trace/Detector, Data, Demod
Mode:	LTE, LTETDD
Initial S/W Revision:	A.02.00
Modified at S/W Revision:	A.03.00
Help Map ID:	30816

Antenna Beam Pattern

Antenna Beam Pattern shows the antenna beam patterns formed by the UE-RS weights for each PDSCH user allocation that uses UE-RS beamforming.

The UE-RS weights for a PDSCH user allocation are computed by calculating the UE-RS weight values for all UE-RS resource elements in the Measurement Interval for the user allocation and then averaging over all resource elements for each receive antenna. The UE-RS weights used to calculate the antenna beam pattern can be seen in the UE-specific RS Weights summary table when Weights Display Mode is set to Per User.

NOTE The LTE demodulator assumes a vertical, linear antenna array with uniform antenna spacing. The spacing is specified by Antenna Element Spacing.

The antenna beam patterns are color-coded to match the color for the corresponding PDSCH user allocation in the Frame Summary.

NOTE UE-RS weights are assumed to be constant over all subframes in the frame.

Only half of the beam pattern is shown, the other half is symmetric about the origin.

The points on this trace are evenly spaced every 0.5 degree.

The magnitudes of the points for a PDSCH antenna beam pattern are normalized to the peak of the beam pattern.

See Data section for the corresponding SCPI command.

Key Path:	Trace/Detector, Data, Demod
-----------	-----------------------------

Mode:	LTE, LTETDD
Initial S/W Revision:	A.10.00
Help Map ID:	40871

Demod Err (Error)

Displays the Trace Data Demod Error choices that show general demodulation results.

Key Path:	Trace/Detector, Data
Mode:	LTE, LTETDD
Initial S/W Revision:	Prior to A.02.00
Modified at S/W Revision:	A.03.00
Help Map ID:	30810

Error Vector Time

This trace shows each of the individual signal error vectors for each subcarrier and symbol vs. Time (symbol) and frequency (subcarrier). Each error vector is the vector difference, for that subcarrier at that symbol-time, between the corresponding IQ Meas value and the IQ Ref value.

On this trace, the individual error vectors are plotted vs Time (symbol). So at each valid symbol, there is a point plotted for each valid subcarrier (52 total, since subcarrier 0 is not used.) In addition, a white trace is drawn, where each point is the RMS average over the valid subcarriers, which is the same result as is plotted separately as RMS Error Vector Time.

See “Data” on page 1141 for the corresponding SCPI command.

Key Path:	Trace/Detector, Data, Demod Error
Mode:	LTE, LTETDD
Initial S/W Revision:	Prior to A.02.00
Modified at S/W Revision:	A.03.00
Help Map ID:	29266

RMS Error Vector Time

The difference between IQ Meas and IQ Ref is the error vector (which will have a complex value) at each subcarrier at each symbol-time. This trace is the RMS average of the error vector for each valid subcarrier at the plotted symbol, the same data shown as a white trace shown in Error Vector Time.

See “Data” on page 1141 for the corresponding SCPI command.

Key Path:	Trace/Detector, Data, Demod Error
Mode:	LTE, LTETDD
Initial S/W Revision:	Prior to A.02.00

Modified at S/W Revision:	A.03.00
Help Map ID:	29268

Error Vector Spectrum

This trace, like Error Vector Time shows each of the individual signal error vectors for each subcarrier and symbol vs. Time (symbol) and frequency (subcarrier). Each error vector is the vector difference, for that subcarrier at that symbol-time, between the corresponding IQ Meas value and the IQ Ref value.

On this trace, the individual error vectors are plotted vs frequency (subcarrier). So at each valid subcarrier, there is a point plotted for each valid symbol. Note that subcarrier 0 is not plotted since it is not used. In addition, a white trace is drawn, where each point is the RMS average over the valid symbols, which is the same result as is plotted separately as RMS Error Vector Spectrum.

See “Data” on page 1141 for the corresponding SCPI command.

Key Path:	Trace/Detector, Data, Demod Error
Mode:	LTE, LTETDD
Initial S/W Revision:	Prior to A.02.00
Modified at S/W Revision:	A.03.00
Help Map ID:	29265

RMS Error Vector Spectrum

This trace is the RMS average of the error vector for each valid symbol at the plotted subcarrier, the same data shown as a white trace shown in Error Vector Time. Note that subcarrier 0 is not plotted since it is not used.

See “Data” on page 1141 for the corresponding SCPI command.

Key Path:	Trace/Detector, Data, Demod Error
Mode:	LTE, LTETDD
Initial S/W Revision:	Prior to A.02.00
Modified at S/W Revision:	A.03.00
Help Map ID:	29267

Common Tracking Error

This trace shows the small scale deviations from the averaged channel response occurring from one symbol to another.

See “Data” on page 1141 for the corresponding SCPI command.

Key Path:	Trace/Detector, Data, Demod Error
Mode:	LTE, LTETDD

Initial S/W Revision:	Prior to A.02.00
Modified at S/W Revision:	A.03.00
Help Map ID:	29269

RB Error Mag Spectrum

This trace shows EVM (calculated as RMS average over one RB and one slot) and as functions of RBs on the X-axis and multiple slots for each RB. This is a frequency-domain trace coupled only to other frequency-domain traces (and not mixed-domain traces).

See “Data” on page 1141 for the corresponding SCPI command.

Key Path:	Trace/Detector, Data, Demod Error
Mode:	LTE, LTETDD
Initial S/W Revision:	Prior to A.02.00
Modified at S/W Revision:	A.03.00
Help Map ID:	29270

RB Error Mag Time

This trace shows EVM (calculated as RMS average over one RB and one slot) and as functions of RBs on the X-axis and multiple slots for each RB. This is a frequency-domain trace coupled only to other frequency-domain traces (and not mixed-domain traces).

See “Data” on page 1141 for the corresponding SCPI command.

Key Path:	Trace/Detector, Data, Demod Error, More
Mode:	LTE, LTETDD
Initial S/W Revision:	Prior to A.02.00
Modified at S/W Revision:	A.03.00
Help Map ID:	29271

RB Power Spectrum

This trace shows power levels (calculated as RMS average over one RB and one slot) as functions of RBs on the X-axis and multiple slots for each RB. This is a frequency-domain trace coupled only to other frequency-domain traces (and not mixed-domain traces).

See “Data” on page 1141 for the corresponding SCPI command.

Key Path:	Trace/Detector, Data, Demod Error, More
Mode:	LTE, LTETDD
Initial S/W Revision:	Prior to A.02.00

Modified at S/W Revision:	A.03.00
Help Map ID:	29272

RB Power vs Time

This trace shows power levels (calculated as RMS average over one RB and one slot) as functions of slots on the X-axis and multiple RBs for each slot. This is a frequency-domain trace coupled only to other frequency-domain traces (and not mixed-domain traces).

See “Data” on page 1141 for the corresponding SCPI command.

Key Path:	Trace/Detector, Data, Demod Error, More
Mode:	LTE, LTETDD
Initial S/W Revision:	Prior to A.02.00
Modified at S/W Revision:	A.03.00
Help Map ID:	29273

Freq Err Per Slot

This trace displays the average frequency error for each slot. The frequency error is expressed as an offset in Hz from the current center frequency setting.

See “Data” on page 1141 for the corresponding SCPI command.

Key Path:	Trace/Detector, Data, Demod Error, More
Mode:	LTE, LTETDD
Initial S/W Revision:	A.03.00
Help Map ID:	29101

IQ Offset Per Slot

IQ Offset Per Slot displays the average IQ Offset for each slot in the Measurement Interval. This trace is only available for uplink signals.

See “Data” on page 1141 for the corresponding SCPI command.

Key Path:	Trace/Detector, Data, Demod Error, More
Mode:	LTE, LTETDD
Initial S/W Revision:	A.03.00
Help Map ID:	29102

In-band Emissions

Shows the resource block power spectrum for the data specified by Measurement Interval and Measurement Offset.

LTE Modulation Analysis Measurement Trace/Detector

This trace is identical to RB Power Spectrum except for two differences. The first difference is that In-band Emissions always includes Non-alloc signals, regardless of the Non-Alloc parameter selection. The second difference is that the RB Power levels are normalized such that the average active RB power is 0 dB.

See “Data” on page 1141 for the corresponding SCPI command.

See Section 6.5.2.3 of 3GPP TS 36.521–1 for more information about in-band emissions measurements.

This trace is available only when Direction is Uplink.

Key Path:	Trace/Detector, Data, Demod Error,
Mode:	LTE, LTETDD
Initial S/W Revision:	A.06.00
Help Map ID:	29329

Tables

Displays the Trace Data choices that are in tabular form, including demodulated symbols tables.

Key Path:	Trace/Detector, Data
Mode:	LTE, LTETDD
Initial S/W Revision:	Prior to A.02.00
Modified at S/W Revision:	A.03.00
Help Map ID:	29274

Error Summary

The Error Summary table shows some metrics calculated from signal demod. The metrics are subject to averaging, unless indicated otherwise. See “Data” on page 1141 for the corresponding SCPI command.

A scrollbar will appear when the contents are too long to be displayed in the window. You can scroll the window without a mouse with the following steps.

1. Press **Next Window** key to select the window you want to scroll.
2. Press **Esc** key to turn off the active function
3. Then, press one of **Arrow** keys.

The following metrics are shown:

- EVM
- EVM Symbol TimeAdjust
- Peak EVM
- Peak EVM location symbol number
- Peak EVM subcarrier number

- Data EVM
- 3GPP-defined QPSK EVM (%rms)
- 3GPP-defined 16QAM EVM (%rms)
- 3GPP-defined 64QAM EVM (%rms)
- RS EVM
- RS Tx. Power (avg)
- OFDM Sym. Tx. Power
- Reference Signal Rx Power (Avg). Downlink only.
- Received Signal Strength Indicator
- Reference Signal Rx Quality. Downlink only.
- Freq Err
- Sync Corr
- Sync Type
- Common Tracking Error
- Sym Clk Err
- Time Offset (not averaged)
- IQ Offset
- IQ Gain Imb
- IQ Quad Err
- IQ Time Skew
- CP Length (not averaged)
- RS-OS/PRS (not averaged) (downlink only)
- Cell ID (not averaged) (downlink only)
- Cell ID Group/Sector (not averaged) (downlink only)

Result name	Displayed Unit	Remote Name	Remote Unit
EVM	%rms*	EVM	%rms
EVM Symbol Timing Adjust	none	EVMSymTimeAdj	none
EVM Pk	%	EVMPeak	%
Peak EVM location symbol number	sym	EVMPeakIdx	sym

LTE Modulation Analysis Measurement
Trace/Detector

Result name	Displayed Unit	Remote Name	Remote Unit
Peak EVM subcarrier number	subcar	EVMPeakSubcarId x	subcar
Data EVM	%rms*	DataEVM	%rms
3GPP-defined QPSK EVM	%rms*	3GPPEVMQPSK	%rms
3GPP-defined 16QAM EVM	%rms*	3GPPEVM16QAM	%rms
3GPP-defined 64QAM EVM	%rms*	3GPPEVM64QAM	%rms
RS EVM	%rms*	RSEVM	%rms
RS Tx. Power (avg)	dBm/subcar	RSTP	dBm
OFDM Sym. Tx. Power	dBm	OSTP	dBm
Reference Signal Rx Power (Avg)	dBm	RSRP	dBm
Received Signal Strength Indicator	dBm	RSSI	dBm
Reference Signal Rx Quality	dB	RSRQ	dB
Frequency Error	Hz	FreqErr	Hz
Sync Corr	%	SyncCorr	%
Sync Type	None	SyncType	none
Common Tracking Error	%rms	CTE	%rms
Symbol Clock Err	ppm	SymClkErr	ppm
Time Offset	s	TimeOffset	sec
IQ Offset	dB	IQOffset	dB
IQ Gain Imbalance	dB	IQGainImb	dB
IQ Quadrature Error	deg	IQQuadErr	deg
IQ Timing Skew	s	IQTimingSkew	sec
CP Length Mode	None	CpLengthMode	None
Cell ID	None	CellId	None
Cell ID Group/Sector	None	CellIdGroupSector	None
RS PRS	None	RSPRS	None

* displayed in dB when Report EVM in dB parameter is On

The error summary values can be obtained using the CALC:EVM:DATA:TABL commands.

See also [Remote SCPI Commands and Data Queries, CALCulate:DATA@25716](#) for more details.

Key Path:	Trace/Detector, Data, Tables
Mode:	LTE, LTETDD
Initial S/W Revision:	Prior to A.02.00
Modified at S/W Revision:	A.03.00, A.06.00, A.11.00
Help Map ID:	29275

Frame Summary

This table shows certain characteristics of each of the logical channels. The list of channels shown is different for Downlink and Uplink. If auto-detection is selected, the list contains only PDSCH1–3, corresponding to the three modulation formats. If a channel is not found in the measurement interval under consideration, it is marked with a ‘...’. Each of the channels shown have the same color coding as used in the IQ demod traces.

See “Data” on page 1141 for the corresponding SCPI command.

A scrollbar will appear when the contents are too long to be displayed in the window. You can scroll the window without a mouse with the following steps.

1. Press **Next Window** key to select the window you want to scroll.
2. Press **Esc** key to turn off the active function
3. Then, press one of **Arrow** keys.

The following are the characteristics that are shown in the Frame Summary Table:

- Channel Name
- Error Vector Magnitude
- Relative Power Level
- Modulation Format
- Number of RBs occupied

When the link direction is downlink, the following channels are shown in the Frame Summary:

- P-SS
- S-SS
- PBCH
- PCFICH
- PHICH
- PDCCH
- RS
- P-RS

- MBSFN-RS
- PMCH
- PDSCH1 to PDSCHn
- Non-Alloc

Result name	Displayed Unit	Remote Name	Remote Unit
PSS EVM	%rms	PSSEVM	%rms
PSS Power	dB	PSSPower	dB
PSS Mod Format	none	PSSModFmt	none
PSS Num Rb	none	PSSNumRb	none
SSS EVM	%rms	SSSEVM	%rms
SSS Power	dB	SSSPower	dB
SSS Mod Format	none	SSSModFmt	none
SSS Num Rb	none	SSSNumRb	none
PBCH EVM	%rms	PBCHEVM	%rms
PBCH Power	dB	PBCHPower	dB
PBCH Mod Format	none	PBCHModFmt	none
PBCH Num Rb	none	PBCHNumRb	none
PCFICH EVM	%rms	PCFICHEVM	%rms
PCFICH Power	dB	PCFICHPower	dB
PCFICH Mod Format	none	PCFICHModFmt	none
PCFICH Num Rb	none	PCFICHNumRb	none
PHICH EVM	%rms	PHICHEVM	%rms
PHICH Power	dB	PHICHPower	dB
PHICH Mod Format	none	PHICHModFmt	none
PHICH Num Rb	none	PHICHNumRb	none
PDCCH EVM	%rms	PDCCHEVM	%rms
PDCCH Power	dB	PDCCHPower	dB
PDCCH Mod Format	none	PDCCHModFmt	none
PDCCH Num Rb	none	PDCCHNumRb	none
RS EVM	%rms	RSEVM	%rms
RS Power	dB	RSPower	dB

Result name	Displayed Unit	Remote Name	Remote Unit
RS Mod Format	none	RSMoFmt	none
RS Num Rb	none	RSNumRb	none
P-RS EVM	%rms	PRSEVM	%rms
P-RS Power	dB	PRSPower	dB
P-RS Mod Format	none	PRSMoFmt	none
P-RS Num Rb	none	PRSNuRb	none
MBSFN-RS EVM	%rms	MBSFNREVM	%rms
MBSFN -RS Power	dB	MBSFNRSPower	dB
MBSFN -RS Mod Format	none	MBSFNRSMoFmt	none
MBSFN -RS Num Rb	none	MBSFNRSNuRb	none
PMCH EVM	%rms	PMCHEVM	%rms
PMCH Power	dB	PMCHPower	dB
PMCH Mod Format	none	PMCHMoFmt	none
PMCH Num Rb	none	PMCHNuRb	none
PDSCHn EVM	%rms	PDSCHnEVM	%rms
PDSCHn Power	dB	PDSCHnPower	dB
PDSCHn Mod Format	none	PDSCHnMoFmt	none
PDSCHn Num Rb	none	PDSCHnNuRb	none
Inactive EVM	%rms	InactiveEVM	%rms
Inactive Power	dB	InactivePower	dB
Inactive Mod Format	none	InactiveMoFmt	none
Inactive Num Rb	none	InactiveNuRb	none

When the link direction is uplink, the following are the channels that are shown in the Frame Summary:

- PUSCH DM-RS
- PUCCH
- PUSCH1 to PUSCHn
- PRACH
- S-RS

- Non-Alloc

Result name	Displayed Unit	Remote Name	Remote Unit
DMRS EVM	%rms	DMRSEVM	%rms
DMRS Power	dB	DMRSPower	dB
DMRS Mod Format	none	DMRSModFmt	none
DMRS Num Rb	none	DMRSNumRb	none
PUCCH EVM	%rms	PUCCH EVM	%rms
PUCCH Power	dB	PUCCH Power	dB
PUCCH Mod Format	none	PUCCH ModFmt	none
PUCCH Num Rb	none	PUCCH NumRb	none
PUSCHn EVM	%rms	PUSCHn EVM	%rms
PUSCHn Power	dB	PUSCHn Power	dB
PUSCHn Mod Format	none	PUSCHn ModFmt	none
PUSCHn Num Rb	none	PUSCHn NumRb	none
PRACH EVM	%rms	PRACHEVM	%rms
PRACH Power	dB	PRACHPower	dB
PRACH Mod Format	none	PRACHModFmt	none
PRACH Num Rb	none	PRACHNumRb	none
SRS EVM	%rms	SRSEVM	%rms
SRS Power	dB	SRSPower	dB
SRS Mod Format	none	SRSModFmt	none
SRS Num Rb	none	SRSNumRb	none
Inactive EVM	%rms	InactiveEVM	%rms
Inactive Power	dB	InactivePower	dB
Inactive Mod Format	none	InactiveModFmt	none
Inactive Num Rb	none	InactiveNumRb	none

These values are never averaged; they always show the results of the current measurement. These results are valid only for the current measurement interval.

Non-Alloc signals consist of unused subcarriers in all shared and control channels. This includes unallocated user data subcarriers, the DC subcarrier, certain RS subcarriers in multi-antenna mode, and unused P-SS and S-SS subcarriers.

Non-Alloc signals include the following:

- Unallocated user data subcarriers
- The unused DC subcarrier
- Unused P-SS and S-SS subcarriers: these signals are 6 RBs (72 subcarriers) wide in the frequency domain, but only the center 62 subcarriers are actually used, and the remaining 10 are set to zero.
- Subcarriers reserved for RS in a multiple antenna port signal. For example, in a four Tx Antenna signal, the transmission from antenna port 0 will not transmit anything on the subcarriers that will be used for RS in the other three antenna port transmissions.

Manually defined and autodetected user allocations are always considered allocated whether or not they are enabled for display in Composite Include and are not included in Non-Alloc.

Non-alloc means only unallocated shared channel subcarriers (those that could be allocated for users but are not). The rest of the traces consider Non-alloc to be any unused subcarrier (whether in control or shared channels).

Any resource elements (subcarriers) contained by a user channel that is present in the Composite Include list are considered allocated, regardless of whether or not the user channel has been selected for analysis and display.

Non-Alloc signal's EVMs are normalized with respect to the signal's average power per subcarrier, since dividing by the reference vector's magnitude (0 in this case) will cause the result to be undefined.

Key Path:	Trace/Detector, Data, Tables
Mode:	LTE, LTETDD
Initial S/W Revision:	Prior to A.02.00
Modified at S/W Revision:	A.03.00
Help Map ID:	29276

Symbols

This table shows the demodulated symbols over the measurement interval. It displays one value per subcarrier for downlink and one value per sample/subcarrier for uplink. In uplink, this is a mixed-domain trace and coupled only to other mixed-domain traces (and not frequency domain traces).

See [“Data” on page 1141](#) for the corresponding SCPI command.

A scrollbar will appear when the contents are too long to be displayed in the window. You can scroll the window without a mouse with the following steps.

1. Press **Next Window** key to select the window you want to scroll.
2. Press **Esc** key to turn off the active function
3. Then, press one of **Arrow** keys.

Key Path:	Trace/Detector, Data, Tables
Mode:	LTE, LTETDD
Initial S/W Revision:	Prior to A.02.00

Modified at S/W Revision:	A.03.00
Help Map ID:	29277

Decoded Symbol Table

When Direction is Downlink, this table shows the decoded values of the physical layer channels: PBCH, PDCCH, PCFICH, and PDSCH. The level of decoding is determined by each channel decoding selection (See “[Decode Type](#)” on page 1081 for details.)

When Direction is Uplink, this table shows descrambled PUSCH data when PUSCH Decoding is set to Descrambled. The default bit order for this trace is MSB-first.

See “[Data](#)” on page 1141 for the corresponding SCPI command.

A scrollbar will appear when the contents are too long to be displayed in the window. You can scroll the window without a mouse with the following steps.

1. Press **Next Window** key to select the window you want to scroll.
2. Press **Esc** key to turn off the active function
3. Then, press one of **Arrow** keys.

Key Path:	Trace/Detector, Data, Tables
Mode:	LTE, LTETDD
Initial S/W Revision:	A.06.00
Help Map ID:	29336

DL Decode Info

DL Decode Info contains the decoded information from PBCH, PDCCH, PCFICH and PDSCH.

The upper section shows the status of the PBCH, PDCCH, PCFICH, and PDSCH decoders (On or Off).

The lower part of the table shows the decoded information for each frame. The data is color coded to match the color of the corresponding channel in the Frame Summary trace.

See “[Data](#)” on page 1141 for the corresponding SCPI command.

A scrollbar will appear when the contents are too long to be displayed in the window. You can scroll the window without a mouse with the following steps.

1. Press **Next Window** key to select the window you want to scroll.
2. Press **Esc** key to turn off the active function
3. Then, press one of **Arrow** keys.

Key Path:	Trace/Detector, Data, Tables
Mode:	LTE, LTETDD
Initial S/W Revision:	A.06.00

Help Map ID:	29338
--------------	-------

UL Decode Info

UL Decode Info contains the decoded information from PUCCH and PUSCH.

The upper section shows the status of the PUCCH and PUSCH decoders (On or Off).

The lower part of the table shows the decoded information for each frame.

See Data section for the corresponding SCPI command.

A scrollbar will appear when the contents are too long to be displayed in the window. You can scroll the window without a mouse with the following steps.

1. Press Next Window key to select the window you want to scroll.
2. Press Esc key to turn off the active function
3. Then, press one of Arrow keys.

Key Path:	Trace/Detector, Data, Tables
Mode:	LTE, LTETDD
Initial S/W Revision:	A.10.00
Help Map ID:	40872

UE-RS Weights

This table shows the channel response for each subcarrier that is assigned to carry UE-specific reference signal.

See “Data” on page 1141 for the corresponding SCPI command.

A scrollbar will appear when the contents are too long to be displayed in the window. You can scroll the window without a mouse with the following steps.

1. Press **Next Window** key to select the window you want to scroll.
2. Press **Esc** key to turn off the active function
3. Then, press one of **Arrow** keys.

Key Path:	Trace/Detector, Data, Tables
Mode:	LTETDD
Initial S/W Revision:	A.06.00
Help Map ID:	29349

Response

Displays the Trace Data choices that show equalizer response results.

Key Path:	Trace/Detector, Data
Mode:	LTE, LTETDD
Initial S/W Revision:	Prior to A.02.00
Modified at S/W Revision:	A.03.00
Help Map ID:	29278

Eq Ch Frequency Response

This trace will show the frequency response of the channel derived from the equalizer coefficients, as a function of subcarriers. How the results are computed depends on the choice of Equalizer Training on the Advanced tab. Equalizer training off and that based on RS alone should yield the same trace, while that based on RS+Data should yield a different trace. This is a frequency domain trace coupled only to other frequency domain traces (and not mixed-domain traces).

See “Data” on page 1141 for the corresponding SCPI command.

Key Path:	Trace/Detector, Data, Response
Mode:	LTE, LTETDD
Initial S/W Revision:	Prior to A.02.00
Modified at S/W Revision:	A.03.00
Help Map ID:	29279

Inst Eq Ch Freq Resp

As Eq Ch Frequency Response, but this trace is not averaged.

See “Data” on page 1141 for the corresponding SCPI command.

Key Path:	Trace/Detector, Data, Response
Mode:	LTE, LTETDD
Initial S/W Revision:	Prior to A.02.00
Modified at S/W Revision:	A.03.00
Help Map ID:	29280

Eq Ch Freq Resp Diff

This is the adjacent difference of the channel frequency response. It shows the ratio of the magnitude of the channel response at adjacent subcarriers, expressed in dB so that an ideal response is flat at 0 dB. This trace is real valued. Because this is adjacent differences, the total number of points in the trace is one less than the number of subcarriers. This trace is averaged if averaging is turned on. This is a

frequency domain trace coupled only to other frequency domain traces (and not mixed-domain traces).
See “Data” on page 1141 for the corresponding SCPI command.

Key Path:	Trace/Detector, Data, Response
Mode:	LTE, LTETDD
Initial S/W Revision:	Prior to A.02.00
Modified at S/W Revision:	A.03.00
Help Map ID:	29281

Inst Eq Ch Freq Resp Diff

As Eq Ch Resp Diff, but this trace is not averaged. See “Data” on page 1141 for the corresponding SCPI command.

Key Path:	Trace/Detector, Data, Response
Mode:	LTE, LTETDD
Initial S/W Revision:	Prior to A.02.00
Modified at S/W Revision:	A.03.00
Help Map ID:	29282

Eq Impulse Response

This shows the impulse response of the equalization filter. The equalizer impulse response is computed by taking the reciprocal of the channel equalizer frequency response, performing data filtering and computations that produce a result length of 4x the FFT length, and then converting to the time domain. The Eq Impulse Response is the computed channel impulse response used to compensate for signal channel response degradation.

See “Data” on page 1141 for the corresponding SCPI command.

Key Path:	Trace/Detector, Data, Response
Mode:	LTE, LTETDD
Initial S/W Revision:	Prior to A.02.00
Modified at S/W Revision:	A.03.00
Help Map ID:	29283

Eq Ch Freq Resp Per Slot

This shows the frequency response of the channel for each slot in the Measurement Interval.

Each slot's channel frequency response is plotted as a separate line with a different color. The colors have no correspondence to other traces or channels. The colors are only used to visually separate each slot's channel frequency response.

See “Data” on page 1141 for the corresponding SCPI command.

NOTE This trace can be used to measure Spectral Flatness as defined in Section 6.5.2.4 of 3GPP TS 36.521–1.

Key Path:	Trace/Detector, Data, Response
Mode:	LTE, LTETDD
Initial S/W Revision:	Prior to A.02.00
Modified at S/W Revision:	A.03.00
Help Map ID:	40862

MIMO

Displays the Trace Data choices that show MIMO results.

Key Path:	Trace/Detector, Data, More
Mode:	LTE, LTETDD
Initial S/W Revision:	Prior to A.02.00
Modified at S/W Revision:	A.03.00
Help Map ID:	40863

Info Table

The measurement automatically detects the presence of signals from all the antenna ports and measures certain metrics related to them only if the antenna port parameter “Reference Tx Antenna Port” on page 771 is set to “auto”. The results are reported in the form of the following table. The number of columns depends on the number of transmit antennas selected. Antenna ports that have not contributed to the composite signal have their corresponding columns displayed simply as “---”.

See “Data” on page 1141 for the corresponding SCPI command.

	Tx0/Rx0	Tx1/Rx0	Tx2/Rx0	Tx3/Rx0
RS Power				
RS EVM				
CPE				
Timing				
Phase				
Freq. Error				
Sym Clock Error				

Key Path:	Trace/Detector, Data, MIMO
Mode:	LTE, LTETDD
Initial S/W Revision:	Prior to A.02.00
Modified at S/W Revision:	A.03.00
Help Map ID:	29284

Ch Freq Resp

This trace shows the channel responses of the paths from all transmitter antenna ports that are auto-detected to exist in the signal. It comprises of up to 4 traces overlaid on top of each other, possibly with some color coding.

See “Data” on page 1141 for the corresponding SCPI command.

Key Path:	Trace/Detector, Data, MIMO
Mode:	LTE, LTETDD
Initial S/W Revision:	Prior to A.02.00
Modified at S/W Revision:	A.03.00
Help Map ID:	29285

Ch Freq Resp Diff

This trace shows the channel response differences of the paths from all transmitter antenna ports that are auto-detected to exist in the signal. It comprises of up to 4 traces overlaid on top of each other, possibly with some color coding.

See “Data” on page 1141 for the corresponding SCPI command.

Key Path:	Trace/Detector, Data, MIMO
Mode:	LTE, LTETDD
Initial S/W Revision:	Prior to A.02.00
Modified at S/W Revision:	A.03.00
Help Map ID:	29286

Eq Impulse Resp

This trace shows the Eq. impulse responses of the paths from all transmitter antenna ports that are auto-detected to exist in the signal. It comprises of up to 4 traces overlaid on top of each other, possibly with some color coding.

See “Data” on page 1141 for the corresponding SCPI command.

Key Path:	Trace/Detector, Data, MIMO
-----------	-----------------------------------

Mode:	LTE, LTETDD
Initial S/W Revision:	Prior to A.02.00
Modified at S/W Revision:	A.03.00
Help Map ID:	29287

MIMO Common Tracking Error

This trace shows the common pilot errors of the paths from all transmitter antenna ports that are auto-detected to exist in the signal. It comprises of up to 4 traces overlaid on top of each other, possibly with some color coding.

See “Data” on page 1141 for the corresponding SCPI command.

Key Path:	Trace/Detector, Data, MIMO
Mode:	LTE, LTETDD
Initial S/W Revision:	Prior to A.02.00
Modified at S/W Revision:	A.03.00
Help Map ID:	29288

ACP

This displays a selection of the ACP result traces. For more information, see Trace/Detector, Data, ACP.

Key Path:	Trace/Detector, Data, ACP
Mode:	LTE, LTETDD
Initial S/W Revision:	Prior to A.02.00
Modified at S/W Revision:	A.03.00
Help Map ID:	29352

OBW

This displays a selection of the OBW result traces. For more information, see Analyzer Setup Functions, Trace/Detector, Data, OBW.

Key Path:	Trace/Detector, Data, OBW
Mode:	LTE, LTETDD
Initial S/W Revision:	Prior to A.02.00
Modified at S/W Revision:	A.03.00
Help Map ID:	29353

Register

This displays a selection of the Data Registers. For more information, see Analyzer Setup Functions, Trace/Detector, Data, Register.

Key Path:	Trace/Detector, Data, Register
Mode:	LTE, LTETDD
Initial S/W Revision:	Prior to A.02.00
Modified at S/W Revision:	A.03.00
Help Map ID:	29354

No Data

A blank display is shown. For more information, see Analyzer Setup Functions, Trace/Detector, Data, No Data

Key Path:	Trace/Detector, Data, No Data
Mode:	LTE, LTETDD
Initial S/W Revision:	Prior to A.02.00
Modified at S/W Revision:	A.03.00
Help Map ID:	29355

Trigger

Displays a menu that enables you to select Trigger Source and control triggering parameters. Trigger Source selection is a measurement local parameter, can be set to each measurement individually. Trigger Source selection for this measurement is Free Run, Video (IF Envelope) and External 1 as follows:

Triggering is used to determine when a measurement should start taking data. There are several available trigger sources. For each trigger source, there are associated setup parameters. Typically, a trigger event is generated when a signal (or a characteristic of the signal) crosses a defined trigger level (or threshold) on a rising or falling slope. The measurement begins at a specified time delay from the trigger point. The delay may be negative, enabling pre-trigger data to be taken. Each trigger source has associated its own trigger level, slope, and delay settings.

See [Trigger@25897](#) for more information.

Key Path:	Trigger
Mode:	LTE, LTETDD
Initial S/W Revision:	Prior to A.02.00
Modified at S/W Revision:	A.03.00
Help Map ID:	Use 25897

View/Display

LTE Modulation Analysis results may be displayed in any trace, and the traces viewed in a variety of layouts that show 1, 2, 3, or 4 traces at a time. Each trace may be scaled as desired regardless of measurement settings, or auto-scaled to reflect measurement settings. Data may be formatted in a variety of ways. (For example, you may view the log magnitude of complex data, the real or imaginary part, etc.) You may use Basic or other Preset Views to view frequently used results, or to provide a familiar starting point from which you may customize your own view.

The view setup can be changed by selections from the View/Display menu, including by pressing View Preset: Basic.

See [View/Display@25898](#) for more information.

Key Path:	Front-panel key
Mode:	LTE, LTETDD
Initial S/W Revision:	Prior to A.02.00
Modified at S/W Revision:	A.03.00
Help Map ID:	Use 25898

Display

Invokes the View/Display, Display menu. For more information, see View/Display, Key and Command Description, Display section.

See [View/Display@25898@i](#) for more information.

Key Path:	View/Display
Mode:	LTE, LTETDD
Initial S/W Revision:	Prior to A.02.00
Modified at S/W Revision:	A.03.00
Help Map ID:	Use 25898

Layout

Invokes the View/Display, Layout menu.

See [View/Display, Layout@25855@i](#) for more information.

Key Path:	View/Display
Mode:	LTE, LTETDD
Initial S/W Revision:	Prior to A.02.00

Modified at S/W Revision:	A.03.00
Help Map ID:	Use 25855

Preset View

This command displays Preset Views that provide a set of trace data displays designed to help accomplish a specific measurement objective. The details of each Preset View are provided in the Help for the individual views.

Key Path:	(SCPI only)
Mode:	LTE, LTETDD
Remote Command:	:DISPlay:EVM:VIEW:PRESet BASic SUMMary RBSLot SUBCarrier MIMO
Example:	DISP:EVM:VIEW:PRES BAS
Preset:	BASic
Initial S/W Revision:	Prior to A.02.00
Modified at S/W Revision:	A.03.00
Help Map ID:	0

Preset View: Basic

This preset view consists of the following traces in a Grid 2x2 layout:

- IQ Meas
- Spectrum
- Error Vector Spectrum
- Error Summary

This layout is set by Meas Preset and is good for insuring that the signal is being demodulated correctly, as well as showing many basic demodulation setup problems.

The Preset View: Basic softkey performs the immediate action of changing the layout and view to this configuration. Preset View is an action, not a state.

Key Path:	View/Display
Mode:	LTE, LTETDD
Remote Command:	:DISPlay:EVM:VIEW:PRESet BASic
Example:	DISP:EVM:VIEW:PRES BAS
Initial S/W Revision:	Prior to A.02.00
Modified at S/W Revision:	A.03.00

Help Map ID: 40858

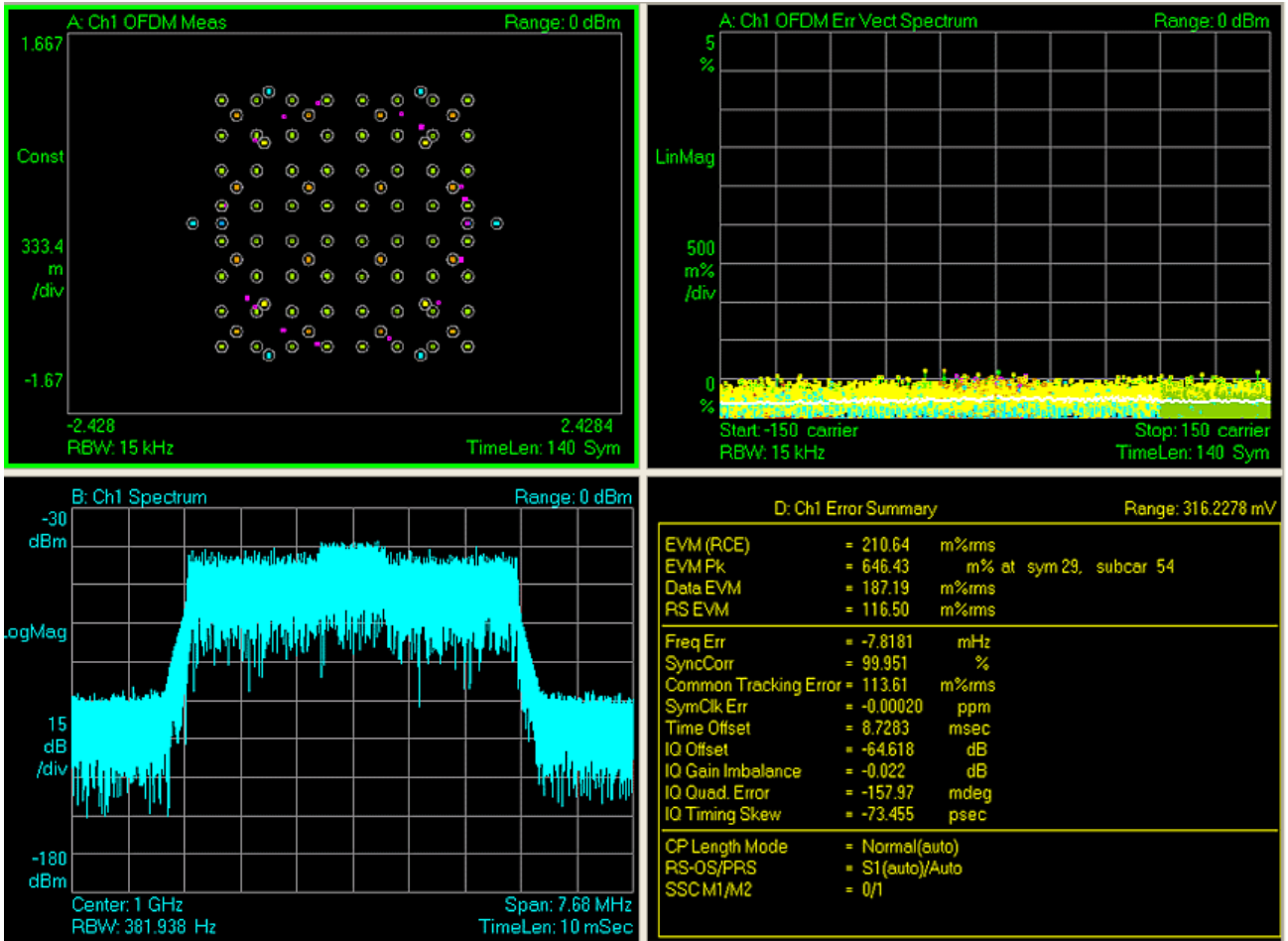

Preset View: Meas Summary

This preset view consists of the following traces in a Stacked layout:

- Error Summary
- Frame Summary

This layout provides the full list of the composite result metrics and characteristics of each of the logical channels.

The Preset View: Meas Summary softkey performs the immediate action of changing the layout and view to this configuration. Preset View is an action, not a state.

Key Path:	View/Display
Mode:	LTE, LTETDD
Remote Command:	:DISPlay:EVM:VIEW:PRESet SUMMary
Example:	DISP:EVM:VIEW:PRES SUMM

LTE Modulation Analysis Measurement
View/Display

Initial S/W Revision:	Prior to A.02.00
Modified at S/W Revision:	A.03.00
Help Map ID:	40859

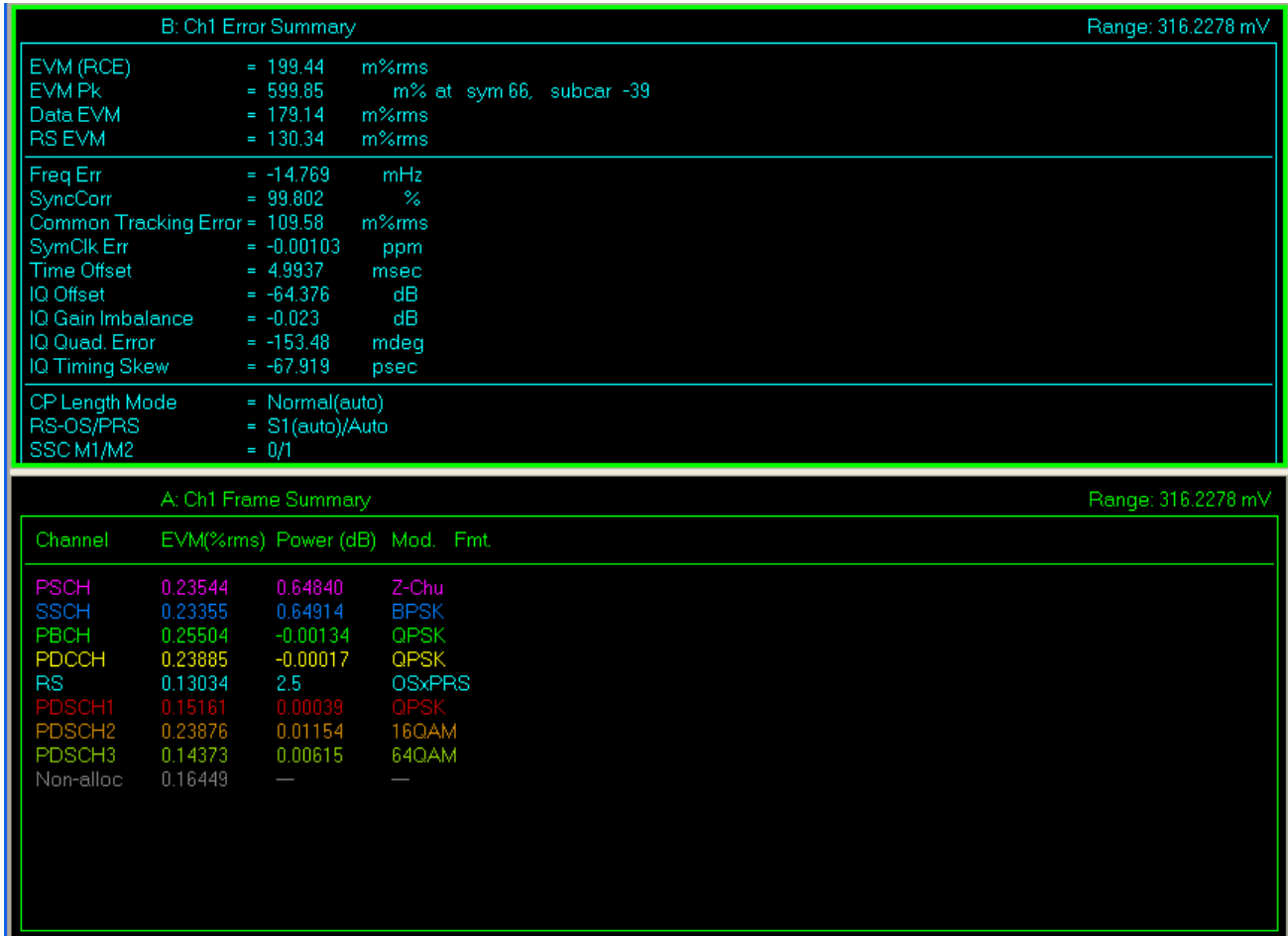

Preset View: RB Slot Meas

This preset view consists of the following traces in a Grid 2x2 layout:

- RB Power vs Spectrum
- RB Error Mag Spectrum
- RB Power vs Time
- RB Error Mag Time

This layout provides the details on the Resource Block.

The Preset View: RB Slot Meas softkey performs the immediate action of changing the layout and view

to this configuration. Preset View is an action, not a state.

Key Path:	View/Display
Mode:	LTE, LTETDD
Remote Command:	:DISPlay:EVM:VIEW:PRESet RBSLot
Example:	DISP:EVM:VIEW:PRES RBSL
Initial S/W Revision:	Prior to A.02.00
Modified at S/W Revision:	A.03.00
Help Map ID:	40860

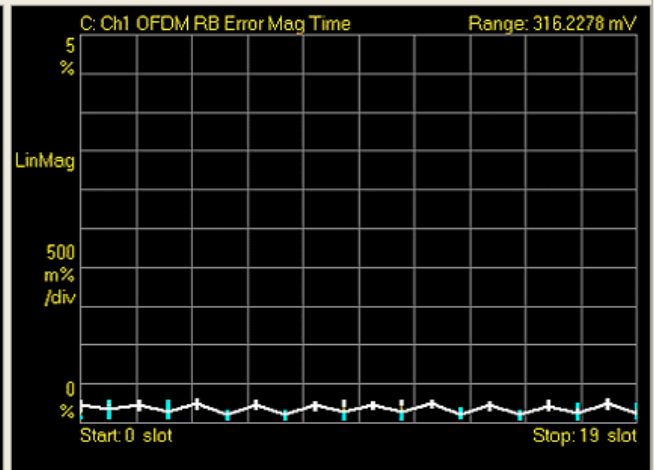
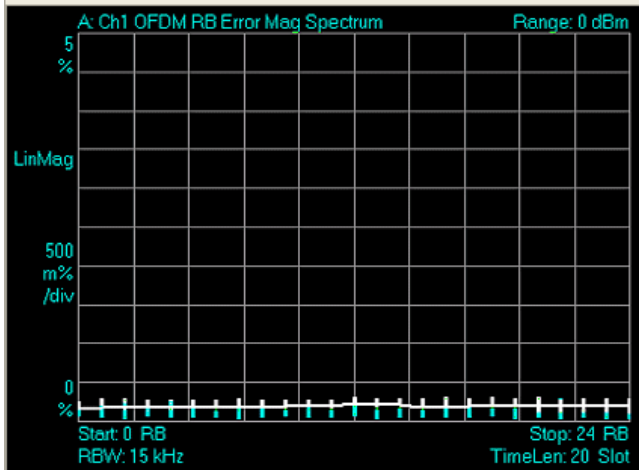
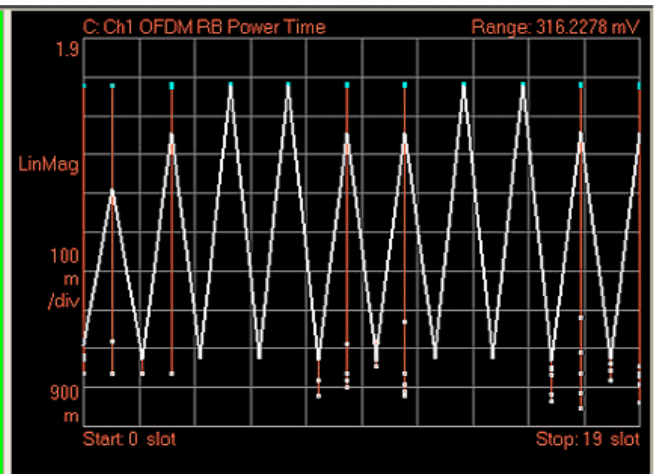
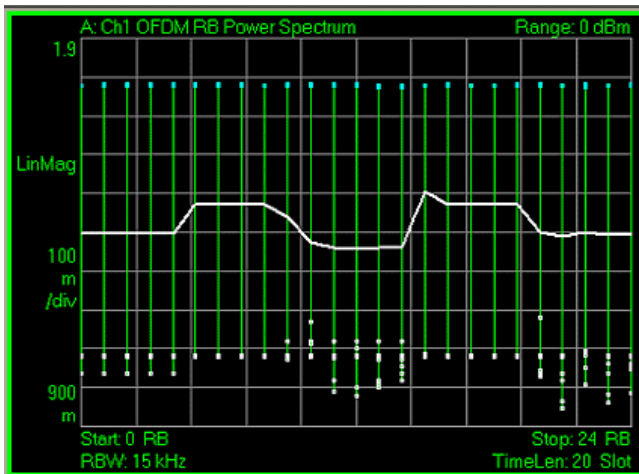

Preset View: Subcarrier Meas

This preset view consists of the following traces in a Grid 2x2 layout:

- Error Vector Spectrum
- IQ Meas (Log Mag)

LTE Modulation Analysis Measurement
View/Display

- Error Vector Time
- IQ Meas Time (Log Mag)

This layout provides the details on the Power and EVM results.

The Preset View: Subcarrier Meas softkey performs the immediate action of changing the layout and view to this configuration. Preset View is an action, not a state.

Key Path:	View/Display, More
Mode:	LTE, LTETDD
Remote Command:	:DISPlay:EVM:VIEW:PRESet SUBCarrier
Example:	DISP:EVM:VIEW:PRES SUBC
Initial S/W Revision:	Prior to A.02.00
Modified at S/W Revision:	A.03.00
Help Map ID:	40861

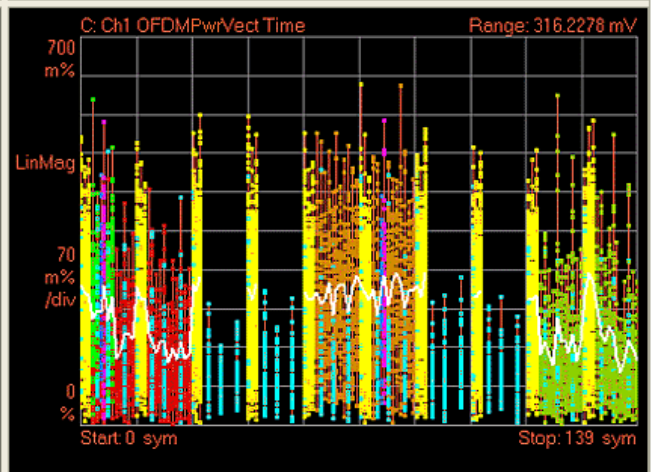
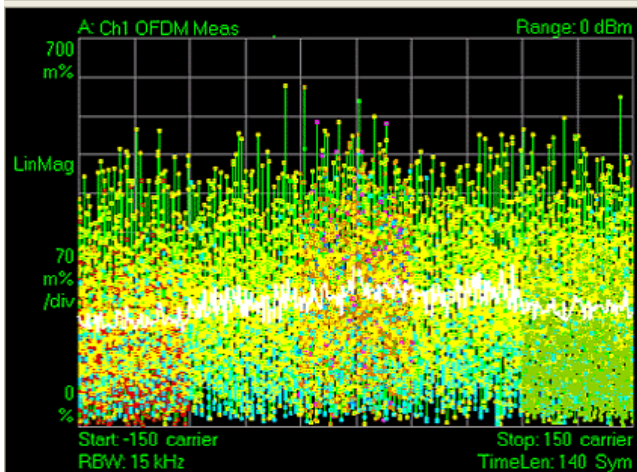
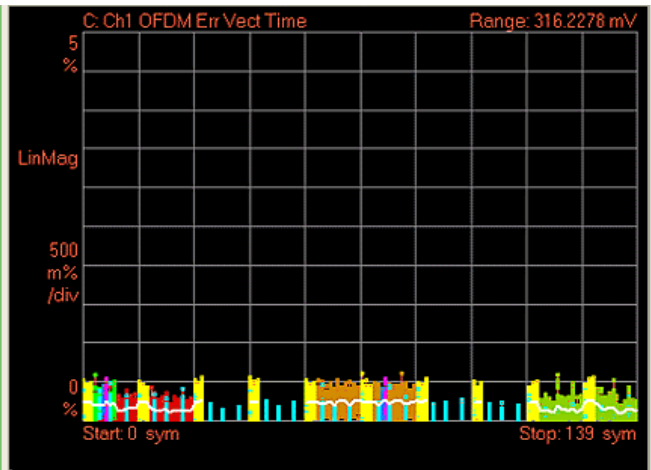
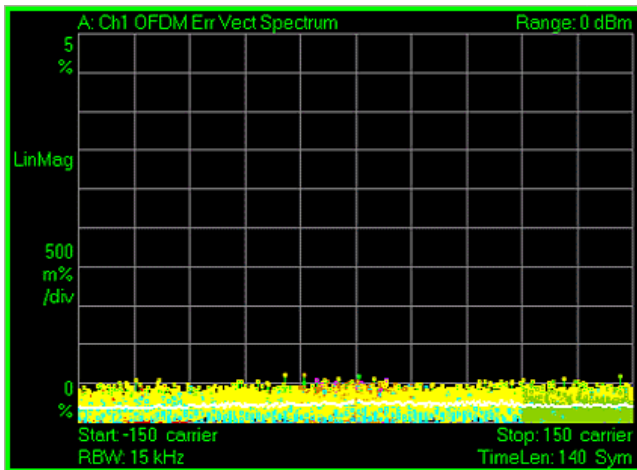

Preset View: MIMO Summary

This preset view consists of the following traces in a Stacked layout:

- MIMO Info Table
- Chan Freq Resp

This layout provides the details on the MIMO results.

The Preset View: MIMO Summary softkey performs the immediate action of changing the layout and view to this configuration. Preset View is an action, not a state.

Key Path:	View/Display, More
Mode:	LTE, LTETDD
Remote Command:	:DISP:lay:EVM:VIEW:PRESet MIMO
Example:	DISP:EVM:VIEW:PRES MIMO
Dependencies:	Available only when Direction is Downlink.
Initial S/W Revision:	Prior to A.02.00
Modified at S/W Revision:	A.03.00
Help Map ID:	29098

The CEVM measurement allows you to measure LTE signals according to 3GPP TS 36.211. The measurement supports all LTE bandwidths plus all modulation formats and sequences for both downlink (OFDMA) and uplink (SC-FDMA) analysis. Once you have configured the measurement, you can use these commands to initiate the measurement and retrieve the measurement results.

[“Measurement Commands for CEVM ” on page 1179](#)

[“Remote Command Results for CEVM Measurement” on page 1179](#)

Measurement Commands for CEVM

This section details remote commands and results. For the front-panel configuration and results, see [“View/Display” on page 1213](#).

```
:CONFigure:CEVM
:CONFigure:CEVM:NDEFault
:FETCh:CEVM [n] ?
:INITiate:CEVM
:MEASure:CEVM [n] ?
:READ:CEVM [n] ?
```

See [Remote SCPI Commands and Data Queries@30187](#) and [Trace/Detector, Data@25798](#) for more measurement SCPI commands.

Remote Command Results for CEVM Measurement

The following table denotes the Conformance EVM specific results returned from the (FETCh|MEASure|READ):CEVM commands, indexed by subopcode. MEASure:CEVM<n> is equivalent to CONF:CEVM;INIT:IMM:FETCh:CEVM<n>, which gets you the default measurement, that is, 5 MHz downlink with auto detection of allocations.

N	Results Returned (Downlink)
Not specified or n=1	<p>The total result length is variable. The returned contents may change depending on the result values' enable/disable setting described in “Result Values” on page 1197. By default, it returns 28 comma-separated scalar results, corresponding exactly to the items shown at Result Metrics View.</p> <ol style="list-style-type: none"> 1. EVM (%rms) 2. EVM Sym Time Adjust 3. EVM Pk (%) 4. EVM Pk Index 5. EVM Peak Sub Car Index 6. Data EVM (%rms) – Not available when Detection is Manual and no User is added. 7. 3GPP-defined QPSK EVM (%rms) 8. 3GPP-defined 16QAM EVM (%rms) 9. 3GPP-defined 64QAM EVM (%rms) 10. RS EVM (%rms) 11. RS Tx. Power (dBm). 12. OFDM Sym. Tx. Power (dBm) 13. Freq Error (Hz) 14. Sync Corr (%) 15. Sync Type 16. Common Tracking Error (%rms) 17. Symbol Clock Error (ppm) 18. Time Offset (s) 19. IQ Offset (dB) 20. IQ Gain Imbalance (dB) 21. IQ Quad Error (deg) 22. IQ Timing Skew (s) 23. CP Length Mode 24. Cell ID. 25. Cell ID Group/Sector 26. RS-OS/PRS 27. Reference Signal Rx Power (Avg) 28. Reference Signal Rx Quality (dB) 29. Received Signal Strength Indicator (dBm)

N	Results Returned (Uplink)
Not specified or n=1	<p>The total result length is variable. The returned contents may change depending on the result values' enable/disable setting described in “Result Values” on page 1197. By default, it returns 23 comma-separated scalar results, corresponding exactly to the items shown at Result Metrics View.</p> <ol style="list-style-type: none"> 1. EVM (%rms) 2. EVM Sym Time Adjust 3. EVM Pk (%) 4. EVM Pk Index 5. EVM Peak Sub Car Index 6. Data EVM (%rms) – Not available when Detection is Manual and no User is added. 7. 3GPP-defined QPSK EVM (%rms) 8. 3GPP-defined 16QAM EVM (%rms) 9. 3GPP-defined 64QAM EVM (%rms) 10. RS EVM (%rms) 11. -999.0 returned. 12. -999.0 returned. 13. Freq Error (Hz) 14. Sync Corr (%) 15. Sync Type 16. Common Tracking Error (%rms) 17. Symbol Clock Error (ppm) 18. Time Offset (s) 19. IQ Offset (dB) 20. IQ Gain Imbalance (dB) 21. IQ Quad Error (deg) 22. IQ Timing Skew (s) 23. CP Length Mode 24. Channel Power (dBm)
n=2	<p>Returns result of Eq Chan Freq Resp Per Slot. The result length varies depending on the Bandwidth and Measurement Interval.</p> <p>For example, BW=5MHz and Result Length & Meas Interval Slot=20 slots, 12,000 points are returned. The first 600 points are 300 IQ pairs of EQ response of Slot 0 from the lowest to the highest frequency, and the second 600 points are those of Slot 1, and so on. Each slot (=EC(f)) is divided into EC_1(f) for Range1 and EC_2(f) for Range2, and then RP1, RP2, RP12 or RP21 is calculated in each region.</p>

Conformance EVM

Key Path:	Meas
Mode:	LTE, LTETDD
Initial S/W Revision:	A.06.30
Modified at S/W Revision:	A.10.01, A.11.00
Help Map ID:	41250

Amplitude (AMPTD) Y Scale

See AMPTD Y Scale, [Amptd/Y Scale@3001](#) for details.

Key Path:	Front-panel key
Help Map ID:	0

Attenuation

See AMPTD Y Scale, [Attenuation@3003](#) for details.

Internal Preamp

See AMPTD Y Scale, [Internal Preamp@3036@i](#) for details.

Auto Couple

See AMPTD Y Scale, [Auto Couple@3041@i](#) for details.

Key Path:	Front-panel key
Help Map ID:	0

BW

Info BW is a SCPI only parameter. No softkey is available.

Key Path:	Front-panel key
Help Map ID:	41280

Info BW

Sets the information bandwidth. SCPI only.

Key Path:	SCPI only														
Mode:	LTE, LTETDD														
Remote Command:	[:SENSe] :CEVM:IFBW <freq> [:SENSe] :CEVM:IFBW?														
Example:	CEVM:IFBW 5MHZ CEVM:IFBW?														
Notes:	SCPI only. Some DIFs only have discrete IF BW settings. In that case, the closest wider BW the HW provides is selected as the Info BW. Info BW is optimized for the measurement speed. Although the user can change this, it could cause a measurement speed degradation especially in DIF cases with Opt.DP2.														
Couplings:	Info BW is automatically overwritten whenever Demod Bandwidth is changed. The following shows the relation between Demod Bandwidth in Mode Parameter and Info BW. <table style="margin-left: 40px;"> <thead> <tr> <th>Demod Bandwidth</th> <th>Info BW</th> </tr> </thead> <tbody> <tr> <td>1.4 MHz</td> <td>3.072 MHz</td> </tr> <tr> <td>3 MHz</td> <td>6.144 MHz</td> </tr> <tr> <td>5 MHz</td> <td>6.144 MHz</td> </tr> <tr> <td>10 MHz</td> <td>12.288 MHz</td> </tr> <tr> <td>15 MHz</td> <td>24.576 MHz</td> </tr> <tr> <td>20 MHz</td> <td>24.576 MHz</td> </tr> </tbody> </table>	Demod Bandwidth	Info BW	1.4 MHz	3.072 MHz	3 MHz	6.144 MHz	5 MHz	6.144 MHz	10 MHz	12.288 MHz	15 MHz	24.576 MHz	20 MHz	24.576 MHz
Demod Bandwidth	Info BW														
1.4 MHz	3.072 MHz														
3 MHz	6.144 MHz														
5 MHz	6.144 MHz														
10 MHz	12.288 MHz														
15 MHz	24.576 MHz														
20 MHz	24.576 MHz														
Preset:	6.144 MHz														
State Saved:	Saved in instrument state.														
Min:	1kHz														
Max:	Lower value of either Digital IF max value or 49.152MHz.														

Conformance EVM
BW

Initial S/W Revision:	A.06.30
Help Map ID:	0

Cont (Continuous)

See Cont@3309@i for details.

Key Path:	Front-panel key
Help Map ID:	0

FREQ Channel

See [FREQ Channel@3057@i](#) for details.

Key Path:	Front-panel key
Help Map ID:	0

Center Freq

See [Center Freq@3059@i](#) for details.

CF Step

See [CF Step@3062@i](#) for details.

Input/Output

See [Input/Output@3065](#) for details.

Key Path:	Front-panel key
Help Map ID:	0

Marker

There is no Marker functionality implemented in this measurement.

Key Path:	Front-panel key
Help Map ID:	41281

Marker Fctn

There is no Marker functionality implemented in this measurement.

Key Path:	Front-panel key
Help Map ID:	41282

Marker > (Marker To)

There is no Marker To functionality implemented in this measurement.

Key Path:	Front-panel key
Help Map ID:	41283

Meas

See Meas@4008@i for details.

Key Path:	Front-panel key
Help Map ID:	0

Meas Setup

Only Copy from Mod Analysis and Meas Preset are available in the Meas Setup menu. The other functions are performed using Remote Commands documented in the following sections, or via setup tables, using the front-panel keys or a mouse and keyboard.

For more information on the measurement setup table screens, see:

Section [“Measurement List view” on page 1213](#) and

Section [“Parameter List view” on page 1214](#)

Key Path:	Front-panel key
Initial S/W Revision:	A.06.30
Help Map ID:	41251

Meas Method (when 85 MHz or wider analysis bandwidth option is installed)

Selects the desired method for the CEVM measurement. This feature is available only when 85 MHz or wider analysis bandwidth option is installed.

NORMAL - Measurement speed is not optimized.

FAST - Measurement speed is optimized and faster than NORMAL. However, measurement settings are limited even in the valid combination of the parameter values. The limitations for Fast mode, See [“Fast Mode Limitation” on page 1195..](#)

Key Path:	Meas Setup
Mode:	LTE
Remote Command:	[:SENSE]:CEVM:METHod NORMAL FAST [:SENSE]:CEVM:METHod?
Example:	CEVM:METH FAST CEVM:METH?
Dependencies:	This parameter is available only when the Wideband DIF (85 MHz or wider) hardware is installed in the instrument.
State Saved:	Saved in instrument state.
Range:	Normal Fast
Initial S/W Revision:	A.10.01
Help Map ID:	41279

Fast Mode Limitation

- "For downlink signals, Fast mode can be used only for E-UTRA test models, the setup files can be recalled by using Recall, Data, EVM Setup.
- "For uplink signals, Fast mode only supports channel configuration for PUSCH, and other channels such as PUCCH are not supported. Multiple users are not supported in Fast mode. The auto function of the parameters must be OFF and see the table below for parameter values, others must be preset value.
- "When Meas Method is FAST, EVM Minimization by IQ Imbalance is not valid and is always OFF to return the measurement results.

Name	SCPI	Fast Mode
RB Auto Detection	[[:SENSe]:CEVM:PROFile:AUTO[:DETECT]]	OFF
Analysis Boundary	[[:SENSe]:CEVM:TIME:ASBoundary]	FRAME
Meas Interval/Offset	[[:SENSe]:CEVM:TIME:INTERVAL:SLOT]	
[[:SENSe]:CEVM:TIME:INTERVAL:SYMBOL]		
[[:SENSe]:CEVM:TIME:OFFSET:SLOT]		
[[:SENSe]:CEVM:TIME:OFFSET:SYMBOL]	Same as Normal Mode	
Sync Type	[[:SENSe]:CEVM:ULINK:SYNC:TYPE]	RS
Cyclic Prefix Length	[[:SENSe]:CEVM:ULINK:SYNC:CPLength]	NORMAL
Add User	[[:SENSe]:CEVM:ULINK:PROFile:ADD:USER]	Only USER[1] is valid.
Include PUSCH	[[:SENSe]:CEVM:ULINK:PROFile:USER:PUSCh]	INCLUDE
PUSCH Active	[[:SENSe]:CEVM:ULINK:PROFile:USER:PUSCh:ACTive]	ON
Include PUSCH DMRS	[[:SENSe]:CEVM:ULINK:PROFile:USER:PUSCh:DMRS]	INCLUDE
PUSCH Auto Calc Params	[[:SENSe]:CEVM:ULINK:PROFile:USER:PUSCh:DMRS:PARams]	Same as Normal Mode
PUSCH n DMRS (1)	[[:SENSe]:CEVM:ULINK:PROFile:USER:PUSCh:DMRS:ONE]	Same as Normal Mode
PUSCH n DMRS (2)	[[:SENSe]:CEVM:ULINK:PROFile:USER:PUSCh:DMRS:TWO]	Same as Normal Mode
Delta SS	[[:SENSe]:CEVM:ULINK:PROFile:USER:PUSCh:DSS]	Same as Normal Mode

Conformance EVM
Meas Setup

Name	SCPI	Fast Mode
Add PUSCH Slot	[[:SENSe]:CEVM:ULINK:PROFile:USER:PUSCh:ADD:SLOT	Same as Normal Mode
User PUSCH RB Start	[[:SENSe]:CEVM:ULINK:PROFile:USER:PUSCh:RB:STARt	Same as Normal Mode
PUSCH Start RB Couple	[[:SENSe]:CEVM:ULINK:PROFile:USER:PUSCh:RB:STARt:COUple	Same as Normal Mode
PUSCH Common RB End	[[:SENSe]:CEVM:ULINK:PROFile:USER:PUSCh:RB:END	Same as Normal Mode
PUSCH End RB Couple	[[:SENSe]:CEVM:ULINK:PROFile:USER:PUSCh:RB:END:COUple	Same as Normal Mode
PUSCH Sync Slot	[[:SENSe]:CEVM:ULINK:PROFile:USER:PUSCh:SSLot	Same as Normal Mode
PUSCH Sync Slot Auto	[[:SENSe]:CEVM:ULINK:PROFile:USER:PUSCh:SSLot:AUTO	OFF
PUSCH Common Mod Type	[[:SENSe]:CEVM:ULINK:PROFile:USER1 50:PUSCh:MODulation:TYPE	Same as Normal Mode
Frequency Hopping	[[:SENSe]:CEVM:ULINK:PROFile:USER:PUSCh:FHOPping	OFF
Group Hopping	[[:SENSe]:CEVM:ULINK:PROFile:USER:HOPping:GRoup	Same as Normal Mode
Seq Hopping	[[:SENSe]:CEVM:ULINK:PROFile:USER1 50:HOPping:SEQuence	Same as Normal Mode
Equalizer Training	[[:SENSe]:CEVM:EQUalizer:TRAIning	RSData

Copy from Mod Analysis Measurement

This immediate action key provides parameter copy function from Mod Analysis Measurement to CEVM.

NOTE This immediate action copies LTE demodulation parameters from the Mod Analysis Measurement to Conformance EVM Measurement. Note that the other parameters such as Attenuation(Range), Trigger, averaging parameters, IFBW, etc. are NOT copied from Mod Analysis Measurement.

Key Path:	Meas Setup
Mode:	LTE, LTETDD
Remote Command:	[[:SENSe]:CEVM:EVM:COPY[:IMMediate]
Example:	CEVM:EVM:COPY

Initial S/W Revision:	A.06.30
Help Map ID:	41252

Meas Preset

This immediately sets all measurement parameters to their Preset values. For more information, see the Preset key in the System Functions section.

Key Path:	Meas Setup
Mode:	LTE, LTETDD
Initial S/W Revision:	A.06.30
Help Map ID:	41253

Result Values

In CEVM, the user can select results displayed in the Result Metrics View. These results are synchronized with the remote SCPI query results for index n=1.

Downlink Result Output Selection

The following table shows the mapping of the Array index and Result parameters.

Index	Result Parameter
1	EVM (%rms)
2	EVM Sym Time Adjust 1: Window Start, 2: Window End, 3: Center, 4: Custom
3	EVM Pk (%)
4	EVM Pk Index
5	EVM Peak Sub Car Index
6	Data EVM (%rms)
7	3GPP-defined QPSK EVM (%rms)
8	3GPP-defined 16QAM EVM (%rms)
9	3GPP-defined 64QAM EVM (%rms)
10	RS EVM (%rms)
11	RS Tx. Power (dBm)
12	OFDM Sym. Tx. Power (dBm)
13	Freq Error (Hz)
14	Sync Corr (%)

Modified at S/W Revision:	A.11.00
Help Map ID:	0

Uplink Result Output Selection

The following table shows the mapping of the Array index and Result parameters.

Index	Result Parameter
1	EVM (%rms)
2	EVM Sym Time Adjust 1: Window Start, 2: Window End, 3: Center, 4: Custom
3	EVM Pk (%)
4	EVM Pk Index
5	EVM Peak Sub Car Index
6	Data EVM (%rms)
7	3GPP-defined QPSK EVM (%rms)
8	3GPP-defined 16QAM EVM (%rms)
9	3GPP-defined 64QAM EVM (%rms)
10	RS EVM (%rms)
11	RS Tx. Power (dBm) Always returns -999.0.
12	OFDM Sym. Tx. Power (dBm) Always returns -999.0.
13	Freq Error (Hz)
14	Sync Corr (%)
15	Sync Type 2: PUSCH-DMRS, 3: PUCCH-DMRS, 4: SRS, 5: PRACH
16	Common Tracking Error (%rms)
17	Symbol Clock Error (ppm)
18	Time Offset (s)
19	IQ Offset (dB)
20	IQ Gain Imbalance (dB)
21	IQ Quad Error (deg)
22	IQ Timing Skew (s)

Conformance EVM
 Meas Setup

Index	Result Parameter
23	CP Length Mode 1: Normal, 2: Extended
24	Channel Power (dBm)

Key Path:	SCPI only
Mode:	LTE, LTETDD
Remote Command:	[:SENSe]:CEVM:ULINk:RESult ON OFF 0 1,... [:SENSe]:CEVM:ULINk:RESult?
Example:	CEVM:ULIN:RES 1,0,0 CEVM:ULIN:RES?
Notes:	Refer to the above table to see the mapping of the index and result parameter. The array length might be expanded for future enhancement.
Preset:	1,1
State Saved:	Saved in instrument state.
Initial S/W Revision:	A.06.30
Modified at S/W Revision:	A.11.00
Help Map ID:	0

Mode

See [Mode@2670](#) for details.

Key Path:	Front-panel key
Help Map ID:	0

Mode Setup

See [Mode Setup@\(LTE\)28881, \(LTE TDD\)4001](#) for details.

Key Path:	Front-panel key
Help Map ID:	0

Peak Search

There is no Peak Search functionality implemented in this measurement.

Key Path:	Front-panel key
Help Map ID:	41287

Recall

See [Recall@2637](#) for details.

Key Path:	Front-panel key
Help Map ID:	0

Restart

See [Restart@3307@i](#) for details.

Key Path:	Front-panel key
Help Map ID:	0

Save

See [Save@2600](#) for details.

Key Path:	Front-panel key
Help Map ID:	0

Single

See [Single@3515@i](#) for details.

Key Path:	Front-panel key
Help Map ID:	0

Source (Internal)

See [Source \(Internal\) @35360@i](#) for details.

Key Path:	Front-panel key
Help Map ID:	0

SPAN X Scale

There is no Span X Scale functionality implemented for this measurement.

Key Path:	Front-panel key
Help Map ID:	41284

Sweep/Control

There is no Sweep/Control functionality implemented in this measurement.

Key Path:	Front-panel key
Help Map ID:	41285

Trace/Detector

There is no Trace/Detector functionality implemented for this measurement.

Key Path:	Front-panel key
Help Map ID:	41286

Trigger

Operation of this key is identical across several measurements. For details about this key, see [Trigger@3371](#).

Key Path:	Front-panel key
Help Map ID:	0

View/Display

Allows you to select the desired measurement view from the following selections:

- MLIS_t – “Measurement List view” on page 1213
- PARAmeter – “Parameter List view” on page 1214
- RESult - “Result Metrics view” on page 1215
- RFENvelope - “RF Envelope view” on page 1216

Key Path:	View/Display
Mode:	LTE,LTETDD
Remote Command:	:DISPlay:CEVM:VIEW[:SElect] MLIS _t PARAmeter RESult RFENvelope :DISPlay:CEVM:VIEW[:SElect] ?
Example:	DISP:CEVM:VIEW RES DISP:CEVM:VIEW?
Preset:	RESult
State Saved:	Saved in instrument state.
Range:	Measurement List Parameter List Result Metrics RF Envelope
Initial S/W Revision:	A.06.30
Help Map ID:	41272

Display

See Display@3440@i for more information.

Measurement List view

By default, this view shows the current status of enabled measurements and results.

When “Show All Items” parameter is enabled from the soft key, all available measurements and items are displayed. The measurement name and items which belong to the unavailable measurements are grayed out.

Conformance EVM
View/Display

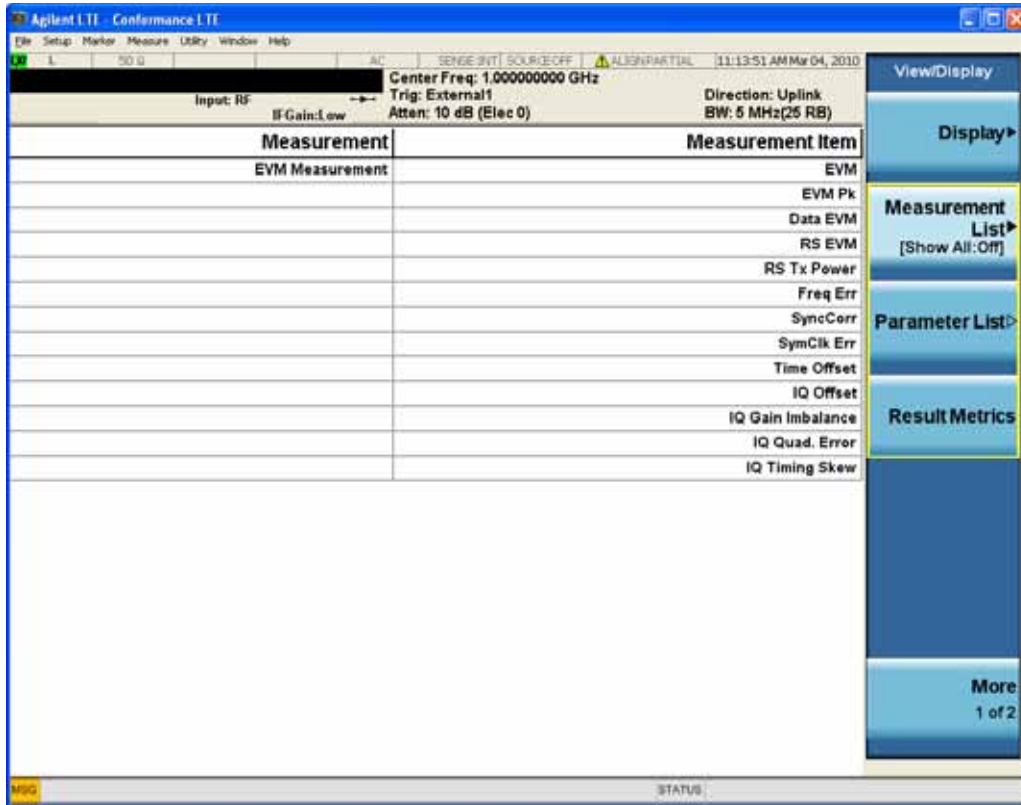

Key Path:	View/Display
Initial S/W Revision:	A.06.30
Help Map ID:	41273

Show All Items

When “Show All Items” is enabled, all available measurements and items are displayed.

The measurement name and items which belong to the unavailable measurements are grayed out.

Key Path:	View/Display, Measurement List
Initial S/W Revision:	A.06.30
Help Map ID:	41274

Parameter List view

This view shows name, remote command and value of available commands for this measurement. You can verify and change values by using the menu, the front panel keys or by using a mouse and keyboard.

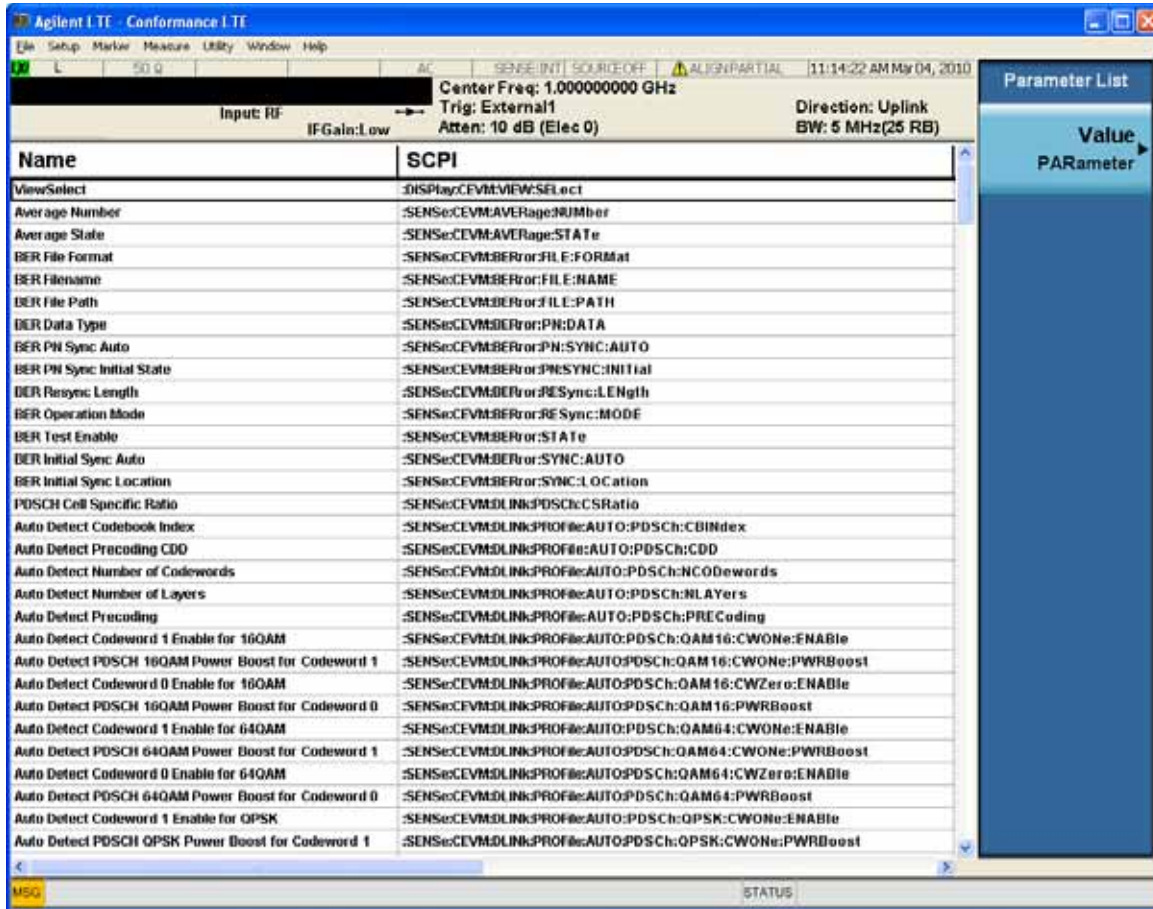

Key Path:	View/Display
Initial S/W Revision:	A.06.30
Help Map ID:	41275

Value

Allows you to refer to and modify the value on the selected row.

Key Path:	View/Display, Parameter List
Initial S/W Revision:	A.06.30
Help Map ID:	41276

Result Metrics view

This view shows measurement results in the same order as the remote command measurement results returned when index (n=1) is sent.

Conformance EVM
View/Display



Key Path:	View/Display
Initial S/W Revision:	A.06.30
Help Map ID:	41277

RF Envelope view

For diagnostic purposes, the RF Envelope view shows a time-domain magnitude plot of each frequency.

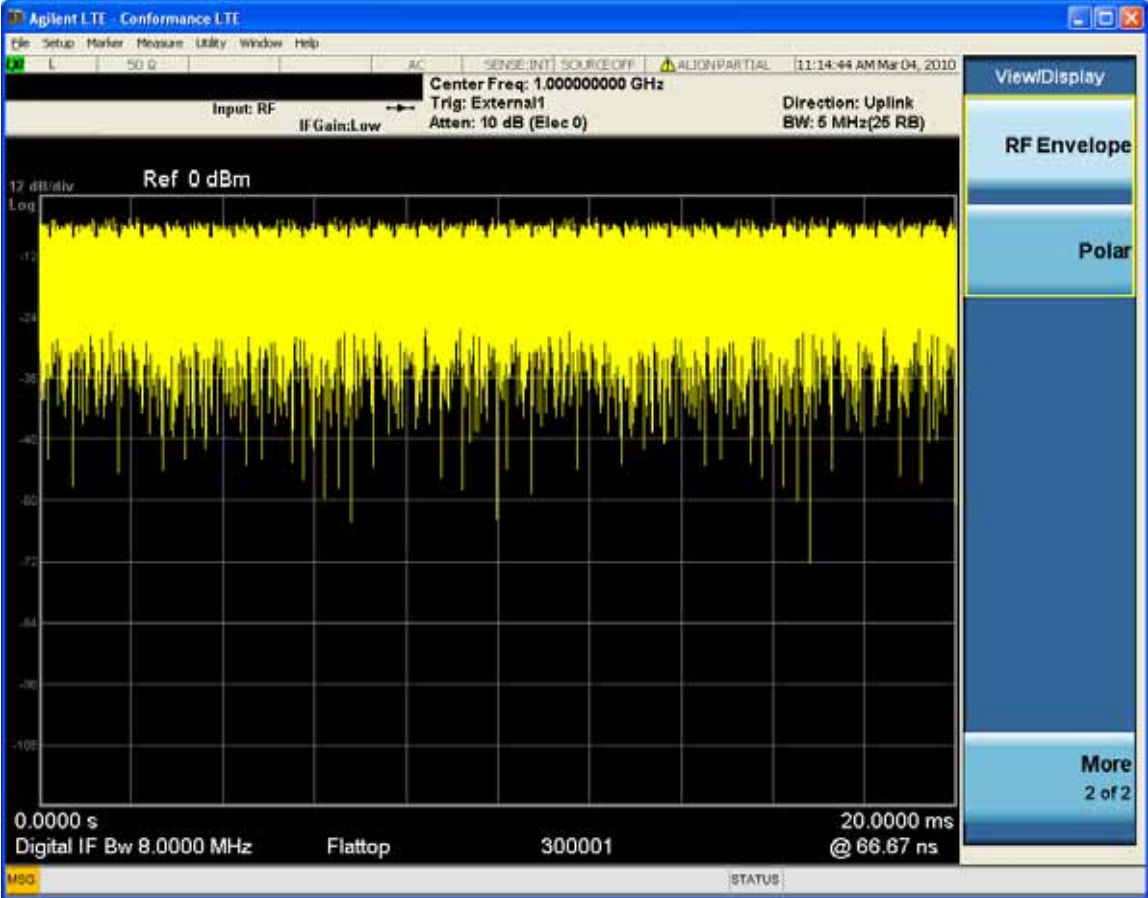

Key Path:	View/Display
Initial S/W Revision:	A.06.30
Help Map ID:	41278

The key and command descriptions in this section describe functions that operate the same in multiple measurements and/or modes. This section is a library of functions that is referenced by many measurements and modes

To find the exact description and parameters for functions in a specific measurement, always look in the measurement section of this documentation. Pressing the front-panel key or key and then pressing the green Help key also provides the correct information.

NOTE

If you want to print the documentation, select this section and the measurement of interest to ensure that you have all the information you need. See [“Printing Acrobat Files” on page 134](#) for further instructions about printing.

Common Measurement Functions 1

The key and command descriptions in this section describe functions that operate identically in multiple measurements and/or modes. This section is a library of functions that is referenced by many measurements and modes.

To find the exact description and parameters for functions in a specific measurement, always look in the measurement section of this documentation. Pressing the front-panel key or softkey and then pressing the green Help key also provides the correct information.

NOTE If you want to print the documentation, be sure to select this section and the measurement of interest to ensure having all the information you need. See [“Printing Acrobat Files” on page 134](#) for further instructions about printing.

AMPTD Y Scale

The Amplitude front-panel key activates the Amplitude menu and selects Reference Level or Reference Value (depending on the measurement) as the active function.

Some features in the Amplitude menu apply to multiple measurements; others apply only to specific measurements. Keys that only apply to some measurements are blanked or grayed out in measurements that are not supported.

Key Path:	Front-panel key
Initial S/W Revision:	Prior to A.02.00
Help Map ID:	3001

Reference Level

The Reference Level specifies the amplitude represented by the topmost graticule line.

Changing the reference level does not restart a measurement, because it is a display function only; instead it vertically ‘pans’ all displayed traces and markers to the new value. If a change to the reference level changes the attenuation value (e.g. through an auto coupling), then the measurement will be restarted.

See [“Amplitude Representations” on page 1222](#)

Key Path:	AMPTD Y Scale
Remote Command:	:DISPlay:WINDow[1]:TRACe:Y[:SCALe]:RLEVel <real> :DISPlay:WINDow[1]:TRACe:Y[:SCALe]:RLEVel?
Example:	DISP:WIND:TRAC:Y:RLEV 20 dBm Sets the reference level to 20 dBm, which displays in the current Y axis unit. For example, if the Y axis unit is dBμV, then 126.99 dBμV will be displayed.

Common Measurement Functions 1

Couplings:	If you reduce the attenuation, the analyzer may have to lower the reference level to keep it below its allowed maximum. This allowed maximum level is specified in the “Max” row, below, along with other variables which affect it. When you increase attenuation, the reference level does not change.
Preset:	0 dBm
State Saved:	Saved in instrument state
Min:	$\text{RefLevelMin} = -170 \text{ dBm} + \text{RefLevelOffset} - \text{ExtGain}$.
Max:	The maximum Ref Level is typically: +30 dBm + RL Offset – External Gain (for MXA and PXA) +23 dBm + RL Offset – External Gain (for EXA and CXA) This maximum value is determined by the maximum power that can be safely applied to the input circuitry. The actual maximum value at any given time may be even less than this, depending on other values including Mech Atten, Int Preamp Gain, Swept IF Gain, FFT IF Gain, Max Mixer Level, and the total attenuation currently available. Note that the maximum reference level is unaffected by the input choice of external mixing.
Default Unit:	Depends on the current selected Y axis unit
Backwards Compatibility Notes:	<ol style="list-style-type: none"> 1. In PSA, there was a restriction on Ref Level Max which was that it could not exceed 0 dBm when the preamp was on. This restriction does not apply to X-Series. 2. Ref Level – Ref Level is a display function, not a measurement control function, so a change in the setting does not start a new sweep (unless attenuation changes). This behavior differs from that of legacy analyzers
Initial S/W Revision:	Prior to A.02.00
Help Map ID:	3002

Amplitude Representations

The following is an illustration of the reference level and Y Axis scales under various conditions:

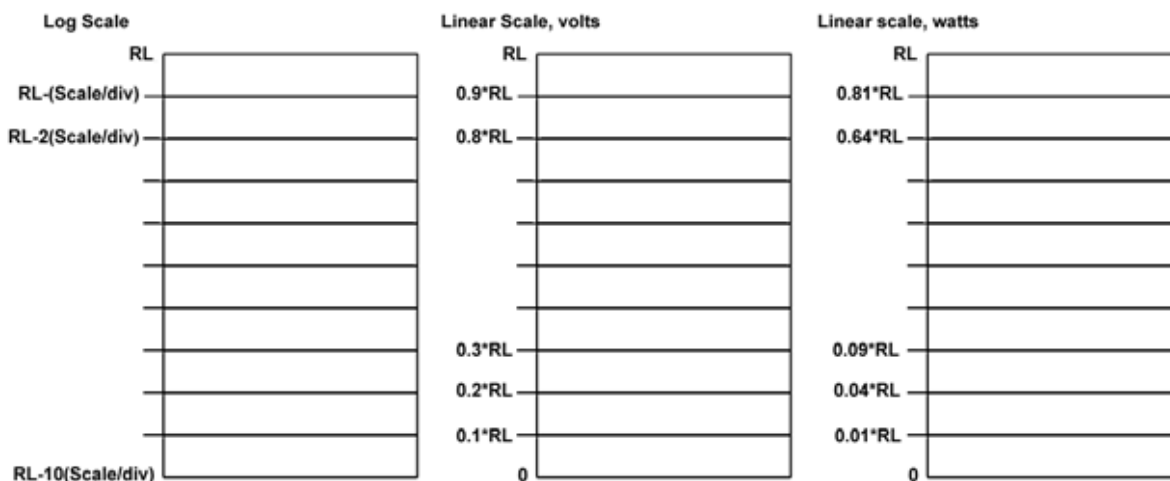

Attenuation

This menu controls the attenuator functions and interactions between the attenuation system components.

There are two attenuator configurations in the X-Series. One is a dual attenuator configuration consisting of a mechanical attenuator and an optional electronic attenuator. The other configuration uses a single attenuator with combined mechanical and electronic sections that controls all the attenuation functions. Different models in the X-Series come with different configurations.

See [“Dual Attenuator Configurations”](#) on page 1224.

See [“Single Attenuator Configuration:”](#) on page 1224

Most Attenuation settings are the same for all measurements – they do not change as you change measurements. Settings like these are called “Meas Global” and are unaffected by Meas Preset.

Key Path:	AMPTD Y Scale
Scope:	Meas Global
Dependencies:	In measurements that support the I/Q inputs, this key is unavailable when I/Q is the selected input, and is replaced by the Range key in that case. Attenuator controls and settings are not available on the E6607C. If any attenuator commands are sent to the E6607C the following error will be generated: -241;Hardware missing; not available for this model number
Readback Line:	Contains a summary in [] brackets of the current total attenuation. See the descriptions of the “(Mech) Atten ” on page 1225, “Enable Elec Atten” on page 1227, and “Elec Atten” on page 1230 keys for more detail on the contributors to the total attenuation. Note that when "Pre-Adjust for Min Clip" is on, this value can change at the start of every measurement.
Initial S/W Revision:	Prior to A.02.00

Common Measurement Functions 1

Modified at S/W Revision:	A.03.00
Help Map ID:	3003

Dual Attenuator Configurations

Configuration 1: Mechanical attenuator + optional electronic attenuator

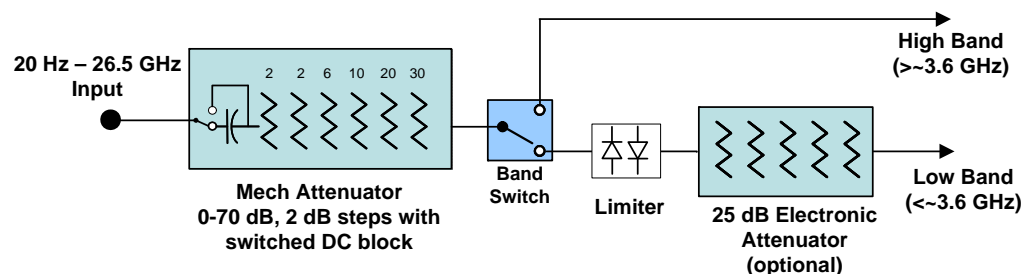

Configuration 2: Mechanical attenuator, no optional electronic attenuator

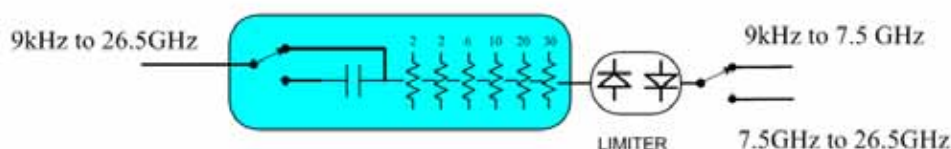

(note that Configuration 2 is not strictly speaking a dual-section attenuator, since there is no electronic section available. However, it behaves exactly like Configuration 1 without the Electronic Attenuator option EA3, therefore for the sake of this document it is grouped into the “Dual Attenuator” configuration)

Single Attenuator Configuration:

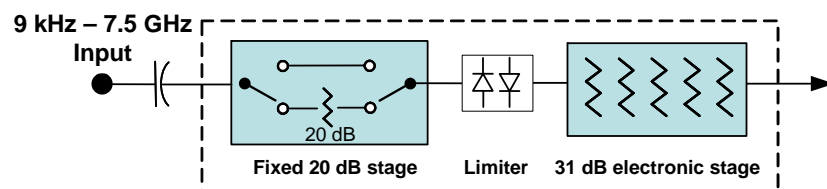

You can tell which attenuator configuration you have by pressing the Attenuation key, which (in most Modes) opens the Attenuation menu. If the first key in the Attenuation menu says **Mech Atten** you have the dual attenuator configuration. If the first key says **Atten** you have the single attenuator configuration.

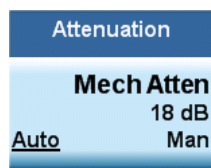

Dual Attenuator

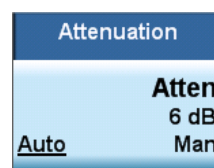

Single Attenuator

In the single attenuator configuration, you control the attenuation with a single control, as the fixed stage has only two states. In the dual attenuator configuration, both stages have significant range so you are given separate control of the mechanical and electronic attenuator stages.

When you have the dual attenuator configuration, you may still have only a single attenuator, because unless option EA3 (the Electronic Attenuator option) is available, and you purchase it, you will have only the mechanical attenuator.

(Mech) Atten

This key is labeled **Mech Atten** in dual attenuator models and **Atten** in single attenuator models. In the dual attenuator configuration, this key only affects the mechanical attenuator.

This key lets you modify the attenuation applied to the RF input signal path. This value is normally auto coupled to the Ref Level, the Internal Preamp Gain, any External Gain that is entered, and the Max Mixer Level, as described in the table below.

See “Attenuator Configurations and Auto/Man” on page 1227

Key Path:	AMPTD Y Scale, Attenuation
Remote Command:	[:SENSe]:POWer[:RF]:ATTenuation <rel_ampl> [:SENSe]:POWer[:RF]:ATTenuation? [:SENSe]:POWer[:RF]:ATTenuation:AUTO OFF ON 0 1 [:SENSe]:POWer[:RF]:ATTenuation:AUTO?
Example:	POW:ATT 20 Dual attenuator configuration: sets the mechanical attenuator to 20 dB Single attenuator mode: sets the main attenuation to 20 dB (see below for definition of “main” attenuation). If the attenuator was in Auto, it sets it to Manual.
Dependencies:	Some measurements do not support the Auto setting of (Mech) Atten . In these measurements, the Auto/Man selection is not available, and the Auto/Man line on the key disappears. In dual attenuator configurations, when the electronic attenuator is enabled, the mechanical attenuator has no auto setting and the Auto/Man line on the key disappears. The state of Auto/Man is remembered and restored when the electronic attenuator is once again disabled. This is described in more detail in the “Enable Elec Atten” on page 1227 key description. See “Attenuator Configurations and Auto/Man” on page 1227 for more information on the Auto/Man functionality of Attenuation.

Common Measurement Functions 1

Couplings:	<p>When (Mech) Atten is in Auto, it uses the following algorithm to determine a value:</p> $\text{Atten} = \text{ReferenceLevel} + \text{PreAmpGain} + \text{ExternalGain} - \text{RefLevelOffset} - \text{MaxMixerLevel} + \text{IF Gain.}$ <p>Limit this value to be between 6 dB and the Max value. No value below 6 dB can ever be chosen by Auto.</p> <p>The resulting value is rounded up to the largest value possible given the attenuation step setting. That is, 50.01 dB would change to 60 dB (for a 10 dB attenuation step).</p> <p>The “IF Gain” term in the equation above is either 0 dB or +10 dB, depending on the settings of FFT IF Gain, Swept IF Gain, max Ref Level and the Auto/Man setting of Mech Atten.</p> <p>In External Mixing and BBIQ, where the Attenuator is not in the signal path, the Attenuator setting changes as described above when (Mech) Atten is in Auto, but no changes are made to the actual attenuator hardware setting until the input is changed back to the RF Input.</p>
Preset:	<p>The preset for Mech Attenuation is “Auto.”</p> <p>The Auto value of attenuation is:</p> <p>CXA, EXA, MXA and PXA: 10 dB</p> <p>EXT: 6dB</p>
State Saved:	Saved in instrument state
Min:	<p>0 dB</p> <p>The attenuation set by this key cannot be decreased below 6 dB with the knob or step keys. To get to a value below 6 dB it has to be directly entered from the keypad or via SCPI. This protects from adjusting the attenuation to a dangerously small value which can put the instrument at risk of damage to input circuitry. However, if the current mechanical attenuation is below 6 dB it can be increased with the knob and step keys, but not decreased.</p>
Max:	<p>CXA N9000A–503/507: 50 dB</p> <p>CXA N9000A–513/526: 70dB</p> <p>EXA: 60 dB</p> <p>MXA and PXA: 70 dB</p> <p>EXT: 70 dB</p> <p>In the single attenuator configuration, the total of ATT and EATT cannot exceed 50 dB, so if the EATT is set to 24 dB first, the main attenuation cannot be greater than 26 dB and will be reduced accordingly; if the main attenuator is set to 40 dB first, EATT cannot be greater than 10 dB.</p>
Initial S/W Revision:	Prior to A.02.00
Modified at S/W Revision:	A.03.00
Help Map ID:	3004

Attenuator Configurations and Auto/Man

As described in the Attenuation key description, there are two distinct attenuator configurations available in the X-Series, the single attenuator and dual attenuator configurations. In dual attenuator configurations, we have the mechanical attenuation and the electronic attenuation, and the current total attenuation is the sum of the electronic + mechanical attenuation. In single attenuator configurations, we refer to the attenuation set using the **(Mech) Atten** key (or POW:ATT SCPI) as the “main” attenuation; and the attenuation that is set by the SCPI command POW:EATT as the “soft” attenuation (the POW:EATT command is honored even in the single attenuator configuration, for compatibility purposes). Then the current total attenuation is the sum of the main + soft attenuation. See the **Elec Atten** key description for more on “soft” attenuation.

In the dual attenuator configuration, when the electronic attenuator is enabled, there is no Auto/Man functionality for the mechanical attenuator, and the third line of the key label (the Auto/Man line) disappears:

Mech Atten
0 dB
Auto Man

Mech Atten
0 dB

Mech Atten when elec atten disabled
--

Mech Atten when elec atten enabled

vsd05

Enable Elec Atten

Enables the Electronic Attenuator.

The electronic attenuator offers finer steps than the mechanical attenuator, has no acoustical noise, is faster, and is less subject to wear. These advantages primarily aid in remote operation and are negligible for front panel use. See [“Using the Electronic Attenuator: Pros and Cons” on page 1229](#) for a detailed discussion of the pros and cons of using the electronic attenuator.

For the single attenuator configuration, for SCPI backwards compatibility, the “soft” attenuation feature replaces the dual attenuator configuration’s electronic attenuator. All the same couplings and limitations apply. See [“Attenuator Configurations and Auto/Man” on page 1227](#)

See [“More Information” on page 1228](#)

Key Path:	AMPTD Y Scale, Attenuation
Remote Command:	[:SENSe] :POWer [:RF] :EATTenuation:STATe OFF ON 0 1 [:SENSe] :POWer [:RF] :EATTenuation:STATe?
Example:	POW:EATT:STAT ON

Common Measurement Functions 1

Dependencies:	<p>This key only appears in Dual Attenuator models with an Electronic Attenuator installed. It does not appear in models with the Single Attenuator configuration, as in the single attenuator configuration there is no “electronic attenuator” there is only a single integrated attenuator (which has both a mechanical and electronic stage). However, in the single attenuator configuration, EATT SCPI commands are accepted for compatibility with other X-series instruments and set a “soft” attenuation as described in “Attenuator Configurations and Auto/Man” on page 1227</p> <p>The electronic attenuator (and the “soft” attenuation function provided in single attenuator configurations) is unavailable above 3.6 GHz. Therefore, if the Stop Frequency of the analyzer is > 3.6 GHz then the Enable Elec Atten key will be OFF and grayed out.</p> <p>If the Internal Preamp is on, meaning it is set to Low Band or Full, the electronic attenuator (and the “soft” attenuation function provided in single attenuator configurations) is unavailable. In this case the Enable Elec Atten key will be OFF and grayed out.</p> <p>If either of the above is true, if the SCPI command is sent, an error indicating that the electronic attenuator is unavailable will be sent.</p> <p>If the electronic/soft Attenuator is enabled, then the Stop Freq of the analyzer is limited to 3.6 GHz and the Internal Preamp is unavailable.</p> <p>The SCPI-only “soft” electronic attenuation for the single-attenuator configuration is not available in all measurements; in particular, it is not available in the Swept SA measurement.</p>
Couplings:	Enabling and disabling the Electronic Attenuator affects the setting of the Mechanical Attenuator (in dual attenuator configurations). This is described in more detail below this table.
Preset:	OFF for Swept SA measurement; ON for all other measurements that support the electronic attenuator
State Saved:	Saved in instrument state
Initial S/W Revision:	Prior to A.02.00
Modified at S/W Revision:	A.03.00
Help Map ID:	3005

More Information

Mechanical Attenuator Transition Rules

When the Electronic Attenuator is enabled, the Mechanical Attenuator transitions to a state that has no Auto function. Below are the rules for transitioning the Mechanical Attenuator. NOTE that the information below ONLY applies to the dual attenuator configurations, and ONLY when the Electronic Attenuator is installed:

When the Electronic Attenuation is enabled from a disabled state:

- The Mechanical Attenuator is initialized to 10 dB (this is its optimal performance setting). You can then set it as desired with SCPI, numeric keypad, step keys, or knob, and it behaves as it normally

would in manual mode

- The Auto/Man state of (Mech) Atten is saved
- The Auto/Man line on the (Mech) Atten key disappears and the auto rules are disabled
- The Electronic Attenuator is set to 10 dB less than the previous value of the Mechanical Attenuator, within the limitation that it must stay within the range of 0 to 24 dB of attenuation.

Examples in the dual attenuator configuration:

- Mech Atten at 20 dB. Elec Atten enabled, Mech Atten set to 10 dB, and Elec Atten set to 10 dB. New total attenuation equals the value before Elec Atten enabled.
- Mech Atten at 0 dB. Elec Atten enabled, Mech Atten set to 10 dB, and Elec Atten set to 0 dB. New total attenuation does not equal the value before Elec Atten enabled.
- Mech Atten at 40 dB. Elec Atten enabled, Mech Atten set to 10 dB, and Elec Atten set to 24 dB. New total attenuation does not equal the value before Elec Atten enabled.

When the Electronic Attenuation is disabled from an enabled state:

- The Elec Atten key is grayed out
- The Auto/Man state of (Mech) Atten is restored
- If now in Auto, (Mech) Atten recouples
- If now in Man, (Mech) Atten is set to the value of total attenuation that existed before the Elec Atten was disabled. The resulting value is rounded up to the smallest value possible given the (Mech) Atten Step setting - (That is, 57 dB changes to 58 dB when (Mech) Atten Step is 2 dB.)

Using the Electronic Attenuator: Pros and Cons

The electronic attenuator offers finer steps than the mechanical attenuator, has no acoustical noise, is faster, and is less subject to wear.

The “finer steps” advantage of the electronic attenuator is beneficial in optimizing the alignment of the analyzer dynamic range to the signal power in the front panel as well as remote use. Thus, you can achieve improved relative signal measurement accuracy. Compared to a mechanical attenuator with 2 dB steps, the 1 dB resolution of the electronic attenuator only gives better resolution when the odd-decibel steps are used. Those odd-decibel steps are less accurately calibrated than the even-decibel steps, so one tradeoff for this superior relative accuracy is reduced absolute amplitude accuracy.

Another disadvantage of the electronic attenuator is that the spectrum analyzer loses its “Auto” setting, making operation less convenient.

Also, the relationship between the dynamic range specifications (TOI, SHI, compression and noise) and instrument performance are less well-known with the electrical attenuator. With the mechanical attenuator, TOI, SHI and compression threshold levels increase dB-for-dB with increasing attenuation, and the noise floor does as well. With the electronic attenuator, there is an excess attenuation of about 1 to 3 dB between 0 and 3.6 GHz, making the effective TOI, SHI, and so forth, less well known. Excess attenuation is the actual attenuation relative to stated attenuation. Excess attenuation is accounted for in the analyzer calibration

Common Measurement Functions 1

Elec Atten

Controls the Electronic Attenuator in dual attenuator configurations. This key does not appear in single attenuator configurations, as the control of both the mechanical and electronic stages of the single attenuator is integrated into the single **Atten** key.

Key Path:	AMPTD Y Scale, Attenuation
Remote Command:	[:SENSE] :POWER[:RF] :EATTenuation <rel_ampl> [:SENSE] :POWER[:RF] :EATTenuation?
Notes:	Electronic Attenuation's specification is defined only when Mechanical Attenuation is 6 dB.
Dependencies:	This key only appears in Dual Attenuator models with an Electronic Attenuator installed. It does not appear in models with the Single Attenuator configuration, as in the single attenuator configuration there is no "electronic attenuator" there is only a single integrated attenuator (which has both a mechanical and electronic stage). However, in the single attenuator configuration, EATT SCPI commands are accepted for compatibility with other X-series instruments and set a "soft" attenuation as described in "Attenuator Configurations and Auto/Man" on page 1227 . The "soft" attenuation is treated as an addition to the "main" attenuation value set by the Atten softkey or the POW:ATT SCPI command and affects the total attenuation displayed on the Attenuation key and the Meas Bar. When Enable Elec Atten is off or grayed out, the Elec Atten key is grayed out.
Preset:	0 dB
State Saved:	Saved in instrument state
Min:	0 dB
Max:	Dual attenuator configuration: 24 dB Single attenuator configuration: the total of ATT and EATT cannot exceed 50 dB, so if the EATT is set to 24 dB first, the main attenuation cannot be greater than 26 dB and will be reduced accordingly; if the main attenuator is set to 40 dB first, EATT cannot be greater than 10 dB
Initial S/W Revision:	Prior to A.02.00
Modified at S/W Revision:	A.03.00
Help Map ID:	3006

Adjust Atten for Min Clip

Sets the combination of mechanical and electronic attenuation based on the current measured signal level so that clipping will be at a minimum.

This is an "immediate action" function, that is, it executes once, when the key is pressed.

This key is grayed out in measurements that do not support this functionality. The spectrum analyzer

measurement, Swept SA, does not support this functionality.

Key Path:	AMPTD Y Scale, Attenuation
Remote Command:	[:SENSE] :POWER [:RF] :RANGE:OPTimize IMMEDIATE
Initial S/W Revision:	Prior to A.02.00
Modified at S/W Revision:	A.03.00
Help Map ID:	3007

Pre-Adjust for Min Clip

If this function is on, it does the adjustment described under “Adjust Atten for Min Clip” on page 1230 each time a measurement restarts. Therefore, in Continuous measurement mode, it only executes before the first measurement.

In dual attenuator models, you can set **Elec+Mech Atten**, in which case both attenuators participate in the autoranging, or **Elec Atten Only**, in which case the mechanical attenuator does not participate in the autoranging. This latter case results in less wear on the mechanical attenuator and is usually faster.

This key is grayed out in measurements that do not support this functionality. The spectrum analyzer measurement, Swept SA, does not support this functionality.

Key Path:	AMPTD Y Scale, Attenuation
Remote Command:	[:SENSE] :POWER [:RF] :RANGE:OPTimize:ATTenuation OFF ELEctrical COMBined [:SENSE] :POWER [:RF] :RANGE:OPTimize:ATTenuation?
Notes:	The SCPI parameter ELEctrical sets this function to On in single attenuator models. The SCPI parameter COMBined is mapped to ELEctrical in single attenuator models; if you send COMBined, it sets the function to On and returns ELEC to a query.
Dependencies:	This key only appears in Dual Attenuator models with an Electronic Attenuator installed. It does not appear in models with the Single Attenuator configuration, as in the single attenuator configuration there is no “electronic attenuator” there is only a single integrated attenuator (which has both a mechanical and electronic stage). When Enable Elec Atten is off or grayed out, the Pre-Adjust for Min Clip key is grayed out.
Preset:	OFF for Swept SA measurement; ON for all other measurements that support Pre-Adjust for Min Clip
State Saved:	Saved in instrument state
Range:	Dual attenuator models: Off Elec Atten Only Mech + Elec Atten Single attenuator models: Off On

Common Measurement Functions 1

Initial S/W Revision:	Prior to A.02.00
Modified at S/W Revision:	A.03.00
Help Map ID:	3008

Remote Command:	[:SENSe] :POWer [:RF] :RANGe:AUTO ON OFF 1 0 [:SENSe] :POWer [:RF] :RANGe:AUTO?
Notes:	ON aliases to "Elec Atten Only" (:POW:RANG:OPT:ATT ELEC) OFF aliases to "Off" (:POW:RANG:OPT:ATT OFF) The query :POW:RANG:AUTO? returns true if :POW:RANG:OPT:ATT is not "Off"
Initial S/W Revision:	Prior to A.02.00
Help Map ID:	0

Off

Turns **Pre-Adjust for Min Clip** off. This is the default setting.

This key is grayed out in measurements that do not support this functionality. The spectrum analyzer measurement, Swept SA, does not support this functionality.

Key Path:	AMPTD Y Scale, Attenuation, Pre-Adjust for Min Clip
Example:	:POW:RANGe:OPT:ATT OFF
Initial S/W Revision:	Prior to A.02.00
Help Map ID:	3010

Elec Atten Only

Selects only the electric attenuator to participate in auto ranging. This offers less wear on the mechanical attenuator and is usually faster.

This key is grayed out in measurements that do not support this functionality. The spectrum analyzer measurement, Swept SA, does not support this functionality.

Key Path:	AMPTD Y Scale, Attenuation, Pre-Adjust for Min Clip
Example:	:POW:RANGe:OPT:ATT ELEC
Initial S/W Revision:	Prior to A.02.00
Help Map ID:	3011

Mech + Elec Atten

In dual attenuator models, this selects both attenuators participate in the autoranging.

This key is grayed out in measurements that do not support this functionality. The spectrum analyzer measurement,

Swept SA, does not support this functionality.

Key Path:	AMPTD Y Scale, Attenuation, Pre-Adjust for Min Clip
Example:	:POW:RANGe:OPT:ATT COMB
Initial S/W Revision:	Prior to A.02.00
Help Map ID:	3012

(Mech) Atten Step

This controls the step size used when making adjustments to the input attenuation.

This key is labeled **Mech Atten Step** in dual attenuator models and **Atten Step** in single attenuator models. In the dual attenuator configuration, this key only affects the step size of the mechanical attenuator.

Key Path:	AMPTD Y Scale, Attenuation
Remote Command:	[:SENSe] :POWer [:RF] :ATTenuation:STEP[:INCRement] 10 dB 2 dB [:SENSe] :POWer [:RF] :ATTenuation:STEP[:INCRement] ?
Example:	POW:ATT:STEP 2
Notes:	Note this feature works like a 1-N choice from the front panel, but it takes a specific value (in dB) when used remotely. The only valid values are 2 and 10.
Dependencies:	Blanked in CXA and EXA if option FSA (2 dB steps) is not present. If blanked, attempts to set it via SCPI will yield an error.
Couplings:	When the attenuation step size changes, the current mechanical attenuation value is adjusted (if necessary) to be quantized to the new step size. That is, if step is set to 10 dB, mech atten is increased if necessary so it is a multiple of 10 dB
Preset:	PXA and MXA: 2 dB EXA and CXA: 10 dB (2 dB with option FSA) EXT: 2 dB
State Saved:	Saved in instrument state
Initial S/W Revision:	Prior to A.02.00
Modified at S/W Revision:	A.03.00
Help Map ID:	3013

Max Mixer Level

Controls the limitation on the Ref Level for a given attenuation setting, and therefore also interacts with

Common Measurement Functions 1

the Auto rules for selecting the attenuation as a coupling from the reference level.

Key Path:	AMPTD Y Scale, Attenuation
Remote Command:	[:SENSE] :POWER [:RF] :MIXer :RANGE [:UPPer] <real> [:SENSE] :POWER [:RF] :MIXer :RANGE [:UPPer] ?
Example:	POW:MIX:RANG -15 dBm
Preset:	-10 dBm
State Saved:	Saved in instrument state
Min:	-50 dBm
Max:	-10 dBm
Default Unit:	Depends on the current selected Y axis unit, see Swept SA discussion of Y Axis Unit
Initial S/W Revision:	Prior to A.02.00
Help Map ID:	3014

Range

This key is only available when I/Q is the selected input. It replaces the Attenuation key in that case.

Each input channel (I and Q) has four internal gain ranges. The maximum allowed voltage in each gain range is slightly more than the nominal value, so the break point between ranges is a couple of millivolts higher than the nominal (setting a peak voltage of 0.502 mV will still map to the 0.5 V Peak range).

Gain Setting	Volts RMS	Volts Peak	Volts Peak - Peak	dBm (50W)	Break Point
0 dB	0.7071	1.0	2.0	10	n/a
6 dB	0.3536	0.5	1.0	4	0.502 V Peak
12 dB	0.1768	0.25	0.5	-2	0.252 V Peak
18 dB	0.0884	0.125	0.25	-8	0.127 V Peak

Key Path:	AMPTD Y Scale
Notes:	Visible only when the selected input is I/Q.
State Saved:	No

Readback Text:	When Range is Auto, "[Auto]" When Range is Man and I & Q are the same, "[<range value>]" When Range is Man and I & Q are different: "[I: <I range value> Q: <Q range value>]" See I Range and Q Range for the <range value> enumeration definition.
Initial S/W Revision:	Prior to A.02.00
Help Map ID:	29880

Range Auto/Man

The Auto setting for Range causes the range to be set based on the Y Scale settings. When Range is “Auto”, the I & Q Range are set based on the top of the Y Scale when the Y scale is in dB units (for example, power), or to the max(abs(top), abs(bottom)) when the Y scale reference is not at the top of the screen.

Not all measurements support Range Auto/Man. If Auto is not supported in the current measurement, this key is grayed out and shows “Man” and MAN is returned to a SCPI query, but this does NOT change the Auto/Man setting for Range. When you go to a measurement that supports Auto, it goes back to Auto if it was previously in Auto mode.

Key Path:	AMPTD Y Scale, Range
Scope:	Meas Global
Remote Command:	[:SENSe] :VOLTage: IQ:RANGe:AUTO OFF ON 0 1 [:SENSe] :VOLTage: IQ:RANGe:AUTO?
Example:	Put the I Range and Q Range in manual. VOLT:IQ:RANG:AUTO OFF
Dependencies:	If Auto is not supported, sending the SCPI command will generate an error.
Couplings:	When in Auto, both I Range and Q Range are set to the same value, computed as follows: Maximum absolute value is computed for the Y Scale. The top and bottom of the graph are computed based on Ref Value, Scale/Div, and Ref Position. Formula: YMax = max(abs(top), abs(bottom)). The I Range and Q Range are then set to YMax.
Preset:	ON
State Saved:	Saved in instrument state
Range:	Auto Man
Initial S/W Revision:	Prior to A.02.00
Help Map ID:	29881

Common Measurement Functions 1

Remote Command:	[:SENSE] :POWER:IQ:RANGE:AUTO OFF ON 0 1 [:SENSE] :POWER:IQ:RANGE:AUTO?
Example:	Put the I Range and Q Range in manual. POW:IQ:RANG:AUTO OFF
Notes:	The POW:IQ:RANG:AUTO is an alternate form of the VOLT:IQ:RANG:AUTO command. This is to maintain consistency with I Range and Q Range, which support both the POWER and VOLTage forms of the command.
Preset:	ON
Range:	Auto Man
Initial S/W Revision:	Prior to A.02.00
Help Map ID:	0

I Range

This is the internal gain range for the I channel when Input Path is I Only or I and I/Q, and it is used for both the I and Q channels when the Input Path is I+jQ. See [“I/Q Gain Ranges” on page 1239](#).

Key Path:	AMPTD Y Scale, Range
Remote Command:	[:SENSE] :VOLTage:IQ[:I]:RANGE[:UPPer] <voltage> [:SENSE] :VOLTage:IQ[:I]:RANGE[:UPPer] ?
Example:	Set the I Range to 0.5 V Peak VOLT:IQ:RANG 0.5 V
Notes:	The numeric entries are mapped to the smallest gain range whose break point is greater than or equal to the value, or 1 V Peak if the value is greater than 1 V.
Couplings:	When Q Same as I is On, the I Range value will be copied to the Q Range. Changing the value will also set Range = Man.
Preset:	1 V Peak
State Saved:	Saved in instrument state
Range:	1 V Peak 0.5 V Peak 0.25 V Peak 0.125 V Peak
Initial S/W Revision:	Prior to A.02.00
Help Map ID:	29883

Remote Command:	[:SENSE] :POWER:IQ[:I]:RANGE[:UPPer] <ampl> [:SENSE] :POWER:IQ[:I]:RANGE[:UPPer] ?
------------------------	---

Example:	Set the I Range to 0.5 V Peak when Reference Z is 50Ω, and to 1.0 V Peak when Reference Z is 75Ω POW:IQ:RANG 4 dBm
Notes:	The POWER form of the command is provided for convenience. It maps to the same underlying gain range parameter as the VOLTage form of the command. The Reference Z (not the I channel Input Z) is used to convert the power to peak voltage, which is then used to set the I Range as with the VOLTage form of the command. The power values of the 4 range states (1V Peak, 0.5V Peak, 0.25V Peak, and 0.125V Peak) will vary with Reference Z. Here are some examples: 50Ω: 10, 4, -2, -8 75Ω: 8.2, 2.2, -3.8, -9.8 600Ω: -0.8, -6.8, -12.8, -18.9
Preset:	10.0 dBm
Range:	-20 dBm to 10 dBm
Min:	-20 dBm
Max:	10 dBm
Initial S/W Revision:	Prior to A.02.00
Help Map ID:	0

Q Range

Accesses the Q Range menu.

Key Path:	AMPTD Y Scale, Range
Readback Text:	Q Same as I 1 V Peak 0.5 V Peak 0.25 V Peak 0.125 V Peak When Q Same as I is On, the readback is "Q Same as I", otherwise it is the Q Range value.
Initial S/W Revision:	Prior to A.02.00
Help Map ID:	29884

Q Same as I

Many, but not all, usages require the I and Q channels to have an identical setup. To simplify channel setup, the Q Same as I will cause the Q channel range to be mirrored from the I channel. That way you only need to set up one channel (the I channel). The I channel values are copied to the Q channel, so at the time Q Same as I is Off, the I and Q channel setups will be identical.

Key Path:	AMPTD Y Scale, Range, Q Range
Remote Command:	[:SENSE] :VOLTage POWer:IQ:MIRROred OFF ON 0 1 [:SENSE] :VOLTage POWer:IQ:MIRROred?

Common Measurement Functions 1

Example:	Turn off the mirroring of I Range to Q Range. VOLT:IQ:MIRR OFF POW:IQ:MIRR OFF
Couplings:	When On, the I Range value is mirrored (copied) to the Q Range.
Preset:	On
State Saved:	Saved in instrument state.
Range:	On Off
Readback Text:	"Q Same as I" when On, otherwise none.
Initial S/W Revision:	Prior to A.02.00
Help Map ID:	29885

Q Range Value

This is the internal gain range for the Q channel. See [“I/Q Gain Ranges” on page 1239](#). The Q Range only applies to Input Path Q Only and Ind I/Q. For input I+jQ the I Range determines both I and Q channel range settings.

Key Path:	AMPTD Y Scale, Range
Remote Command:	[:SENSE] :VOLTage :IQ:Q:RANGe [:UPPer] <voltage> [:SENSE] :VOLTage :IQ:Q:RANGe [:UPPer] ?
Example:	Set the Q Range to 0.5 V Peak VOLT:IQ:Q:RANG 0.5 V
Notes:	The numeric entries are mapped to the smallest gain range whose break point is greater than or equal to the value, or 1 V Peak if the value is greater than 1 V. The Q Range is only used for Input Path Q Only and Ind I/Q. For input I+jQ the I Range determines both I and Q channel range settings.
Couplings:	When Q Same as I is On, the I Range value will be copied to the Q Range and the range value keys are disabled. Changing the value will also set Range = Man.
Preset:	1 V Peak
State Saved:	Saved in instrument state
Range:	1 V Peak 0.5 V Peak 0.25 V Peak 0.125 V Peak
Initial S/W Revision:	Prior to A.02.00
Help Map ID:	29886

Remote Command:	[:SENSE] :POWER: IQ:Q:RANGe [:UPPer] <ampl> [:SENSE] :POWER: IQ:Q:RANGe [:UPPer] ?
-----------------	---

Example:	Will set the Q Range to 0.5 V Peak when Reference Z is 50Ω, and to 1.0 V Peak when Reference Z is 75Ω POW:IQ:Q:RANG 4 dBm
Notes:	The POWER form of the command is provided for convenience. It maps to the same underlying gain range parameter as the VOLTage form of the command. The Reference Z (not the Q channel Input Z) is used to convert the power to peak voltage, which is then used to set the Q Range as with the VOLTage form of the command. The power values of the 4 range states (1V Peak, 0.5V Peak, 0.25V Peak, and 0.125V Peak) will vary with Reference Z. Here are some examples: 50Ω: 10, 4, -2, -8 75Ω: 8.2, 2.2, -3.8, -9.8 600Ω: -0.8, -6.8, -12.8, -18.9
Preset:	10.0 dBm
Range:	-20 dBm to 10 dBm
Min:	-20 dBm
Max:	10 dBm
Initial S/W Revision:	Prior to A.02.00
Help Map ID:	0

I/Q Gain Ranges

See the following sections:

1 V Peak

[“0.5 V Peak” on page 1240](#)

[“0.25 V Peak” on page 1240](#)

[“0.125 V Peak” on page 1240](#)

1 V Peak

Set the channel gain state to 1 Volt Peak.

Key Path:	AMPTD Y Scale, I Range Q Range
Initial S/W Revision:	Prior to A.02.00
Help Map ID:	29887

Common Measurement Functions 1

0.5 V Peak

Set the channel gain state to 0.5 Volt Peak.

Key Path:	AMPTD Y Scale, I Range Q Range
Initial S/W Revision:	Prior to A.02.00
Help Map ID:	29888

0.25 V Peak

Set the channel gain state to 0.25 Volt Peak.

Key Path:	AMPTD Y Scale, I Range Q Range
Initial S/W Revision:	Prior to A.02.00
Help Map ID:	29889

0.125 V Peak

Set the channel gain state to 0.125 Volt Peak.

Key Path:	AMPTD Y Scale, I Range Q Range
Initial S/W Revision:	Prior to A.02.00
Help Map ID:	29890

Scale / Div

Sets the units per vertical graticule division on the display. This function is only available when Scale Type (Log) is selected and the vertical scale is power. When Scale Type (Lin) is selected, Scale/Div is grayed out.

Key Path:	AMPTD Y Scale
Remote Command:	:DISPlay:WINDow[1]:TRACe:Y[:SCALE]:PDIVision <rel_amp1> :DISPlay:WINDow[1]:TRACe:Y[:SCALE]:PDIVision?
Example:	DISP:WIND:TRAC:Y:PDIV 5 DB
Dependencies:	Scale/Div is grayed out in linear Y scale. Sending the equivalent SCPI command does change the Scale/Div, though it has no affect while in Lin.
Preset:	10.00 dB / Div
State Saved:	Saved in instrument state
Min:	0.10 dB
Max:	20 dB
Initial S/W Revision:	Prior to A.02.00

Help Map ID:

3015

Scale Type

Chooses a linear or logarithmic vertical scale for the display and for remote data readout.

When Scale Type (Log) is selected, the vertical graticule divisions are scaled in logarithmic units. The top line of the graticule is the Reference Level and uses the scaling per division Scale/Div to assign values to the other locations on the graticule.

When Scale Type (Lin) is selected, the vertical graticule divisions are linearly scaled with the reference level value at the top of the display and zero volts at the bottom. Each vertical division of the graticule represents one-tenth of the Reference Level.

NOTE The Y Axis Unit used for each type of display is set by pressing Y Axis Unit. The analyzer remembers separate Y Axis Unit settings for both Log and Lin.

Key Path:	AMPTD Y Scale
Remote Command:	:DISPlay:WINDow[1]:TRACe:Y[:SCALe]:SPACing LINear LOGarithmic :DISPlay:WINDow[1]:TRACe:Y[:SCALe]:SPACing?
Example:	DISP:WIND:TRAC:Y:SPAC LOG DISP:WIND:TRAC:Y:SPAC?
Dependencies:	If Normalize is on, Scale Type forced to Log and is grayed out.
Couplings:	Changing the Scale Type always sets the Y Axis unit to the last unit specified for the current amplitude scale. In other words, we restore the Y Axis unit setting appropriate per log/lin.
Preset:	LOG
State Saved:	Saved in instrument state
Initial S/W Revision:	Prior to A.02.00
Help Map ID:	3016

Presel Center

When this key is pressed, the centering of the preselector filter is adjusted to optimize the amplitude accuracy at the frequency of the selected marker. If the selected marker is not on when Presel Center is pressed, the analyzer will turn on the selected marker, perform a peak search, and then perform centering on the marker's center frequency. If the selected marker is already on and between the start and stop frequencies of the analyzer, the analyzer performs the preselector calibration on that marker's frequency. If the selected marker is already on, but outside the frequency range between Start Freq and Stop Freq, the analyzer will first perform a peak search, and then perform centering on the marker's center frequency.

The value displayed on the **Presel Adjust** key will change to reflect the new preselector tuning (see

Common Measurement Functions 1

Presel Adjust.

A number of considerations should be observed to ensure proper operation. See “[Proper Preselector Operation](#)” on page 1242.

Key Path:	AMPTD Y Scale
Remote Command:	[:SENSE] :POWER [:RF] :PCENter
Example:	POW:PCEN
Notes:	Note that the rules outlined above under the key description apply for the remote command as well as the key. The result of the command is dependent on marker position, and so forth. Any message shown by the key press is also shown in response to the remote command.
Dependencies:	<ul style="list-style-type: none"> • Grayed out if the microwave preselector is off.) • If the selected marker’s frequency is below Band 1, advisory message 0.5001 is generated and no action is taken. • Grayed out if entirely in Band 0. • Blank in models that do not include a preselector, such as option 503. If the SCPI is sent in these instruments, it is accepted without error, and the query always returns 0. • Grayed out in the Spectrogram View.
Couplings:	The active marker position determines where the centering will be attempted. If the analyzer s in a measurement such as averaging when centering is initiated, the act of centering the preselector will restart averaging but the first average trace will not be taken until the centering is completed.
Status Bits/OPC dependencies:	When centering the preselector, *OPC will not return true until the process is complete and a subsequent measurement has completed, nor will results be returned to a READ or MEASure command. The Measuring bit should remain set while this command is operating and should not go false until the subsequent sweep/measurement has completed.
Initial S/W Revision:	Prior to A.02.00
Modified at S/W Revision:	A.03.00
Help Map ID:	3017

Proper Preselector Operation

A number of considerations should be observed to ensure proper operation:

1. If the selected marker is off, the analyzer will turn on a marker, perform a peak search, and adjust the preselector using the selected marker's frequency. It uses the "highest peak" peak search method unqualified by threshold or excursion, so that there is no chance of a 'no peak found' error. It continues with that peak, even if it is the peak of just noise. Therefore, for this operation to work properly, there should be a signal on screen in a preselected range for the peak search to find.
2. If the selected marker is already on, the analyzer will attempt the centering at that marker's frequency. There is no preselector for signals below about 3.6 GHz, therefore if the marker is on a signal below 3.6 GHz, no centering will be attempted and an advisory message generated
3. In some models, the preselector can be bypassed. If it is bypassed, no centering will be attempted in that range and a message will be generated.

Preselector Adjust

Allows you to manually adjust the preselector filter frequency to optimize its response to the signal of interest. This function is only available when [“Presel Center” on page 1241](#) is available.

For general purpose signal analysis, using Presel Center is recommended. Centering the filter minimizes the impact of long-term preselector drift. Presel Adjust can be used instead to manually optimize the preselector. One application of manual optimization would be to peak the preselector response, which both optimizes the signal-to-noise ratio and minimizes amplitude variations due to small (short-term) preselector drifting.

Key Path:	AMPTD Y Scale
Scope:	Meas Global
Remote Command:	[:SENSE] :POWER [:RF] :PADJust <freq> [:SENSE] :POWER [:RF] :PADJust?
Example:	POW:PADJ 100KHz POW:PADJ?
Notes:	The value on the key reads out to 0.1 MHz resolution.
Dependencies:	<ul style="list-style-type: none"> • Grayed out if microwave preselector is off.) • Grayed out if entirely in Band 0. • Blank in models that do not include a preselector, such as option 503. If the SCPI is sent in these instruments, it is accepted without error, and the query always returns 0. • Grayed out in the Spectrogram View.
Preset:	0 MHz
State Saved:	The Presel Adjust value set by Presel Center , or by manually adjusting Presel Adjust , is not saved in instrument state, and does not survive a Preset or power cycle.

Common Measurement Functions 1

Min:	-500 MHz
Max:	500 MHz
Default Unit:	Hz
Backwards Compatibility SCPI:	[:SENSe]:POWer[:RF]:MW:PADJust [:SENSe]:POWer[:RF]:MMW:PADJust PSA had multiple preselectors, but the X-Series has only one. These commands simply alias to [:SENSe]:POWer[:RF]:PADJust
Initial S/W Revision:	Prior to A.02.00
Modified at S/W Revision:	A.03.00
Help Map ID:	3020

Remote Command:	[:SENSe]:POWer[:RF]:PADJust:PRESelector MWAVE MMWave EXTernal [:SENSe]:POWer[:RF]:PADJust:PRESelector?
Notes:	PSA had multiple preselectors, and you could select which preselector to adjust. Since the X-Series has only one mm/uW preselector, the preselector selection softkey is no longer available. However, to provide backward compatibility, we accept the legacy remote commands. The command form has no effect, the query always returns MWAVE
Initial S/W Revision:	Prior to A.02.00
Help Map ID:	0

Y Axis Unit

Displays the menu keys that enable you to change the vertical (Y) axis amplitude unit. The analyzer retains the entered Y Axis Unit separately for both Log and Lin amplitude scale types. For example, if Scale Type has been set to Log, and you set Y Axis Unit to dBm, pressing Scale Type (Log) sets the Y Axis Unit to dBm. If Scale Type has been set to Lin and you set Y Axis Unit to V, pressing Scale Type (Lin) sets the Y Axis Unit to V. Pressing Scale Type (Log) again sets the Y axis unit back to dBm.

NOTE	<p>The units of current (A, dBmA, dBuA) are calculated based on 50 ohms input impedance.</p> <p>All four of the EMI units (dBμA/m, dBμV/m, dBG, dBpT) are treated by the instrument exactly as though they were dBuV. The user must load an appropriate correction factor using Amplitude Corrections for accurate and meaningful results.</p> <p>If a SCPI command is sent to the analyzer that uses one of the EMI units as a terminator, the analyzer treats it as though DBUV had been sent as the terminator.</p>
-------------	--

Key Path:	AMPTD Y Scale
Mode:	SA
Scope:	Meas Global
Remote Command:	:UNIT:POWer DBM DBMV DBMA V W A DBUV DBUA DBPW DBUVM DBUAM DBPT DBG :UNIT:POWer?
Example:	UNIT:POW dBmV UNIT:POW?
Notes:	The Y axis unit has either logarithmic or linear characteristics. The set of units that is logarithmic consists of dBm, dBmV, dBmA, dBμV, dBμA, dBμV/m, dBμA/m, dBpT, and dBG. The set of units that are linear consists of V, W, and A. The chosen unit will determine how the reference level and all the amplitude-related outputs like trace data, marker data, etc. read out.
Notes:	The settings of Y Axis Unit and Scale Type, affect how the data is read over the remote interface. When using the remote interface no unit is returned, so you must know what the Y axis unit is to interpret the results: Example 1, set the following: Scale Type (Log) Y Axis Unit, dBm Scale/Div, 1 dB Ref Level, 10 dBm This sets the top line to 10 dBm with each vertical division representing 1 dB. Thus, if a point on trace 1 is on the fifth graticule line from the top, it represents 5 dBm and will read out remotely as 5. Example 2, set the following: Scale Type (Lin) Y Axis Unit, Volts Ref Level, 100 mV (10 mV/div) This sets the top line to 100 mV and the bottom line to 0 V, so each vertical division represents 10 mV. Thus, if a point on trace 1 is on the fifth graticule line from the top, it represents 50 mV and will read out remotely as 50.
Dependencies:	If an amplitude correction with an Antenna Unit other than None is applied and enabled, then that antenna unit is forced and the key with that unit is the only Y Axis Unit available. All other Y Axis Unit keys are grayed out. If an amplitude correction with an Antenna Unit other than None is applied and enabled, and you then turn off that correction or set Apply Corrections to No , the Y Axis Unit that existed before the Antenna Unit was applied is restored.

Common Measurement Functions 1

Couplings:	The analyzer retains the entered Y Axis Unit separately for both Log and Lin amplitude scale types
Preset:	dBm for log scale, V for linear. The true 'preset' value is dBm, since at preset the Y Scale type is set to logarithmic.
State Saved:	Saved in instrument state
Readback line:	1-of-N selection
Initial S/W Revision:	Prior to A.02.00
Modified at S/W Revision:	A.02.00, A.04.00, A.11.00
Help Map ID:	3021

dBm

Sets the amplitude unit for the selected amplitude scale (log/lin) to dBm.

Key Path:	AMPTD Y Scale, Y Axis Unit
Example:	UNIT:POW DBM
Dependencies:	Grayed out if an Amplitude Correction with an Antenna Unit is ON.
Readback:	dBm
Initial S/W Revision:	Prior to A.02.00
Modified at S/W Revision:	A.02.00
Help Map ID:	3022

dBmV

Sets the amplitude unit for the selected amplitude scale (log/lin) to dBmV.

Key Path:	AMPTD Y Scale, Y Axis Unit
Example:	UNIT:POW DBMV
Dependencies:	Grayed out if an Amplitude Correction with an Antenna Unit is ON.
Readback:	dBmV
Initial S/W Revision:	Prior to A.02.00
Modified at S/W Revision:	A.02.00
Help Map ID:	3023

dBmA

Sets the amplitude unit for the selected amplitude scale (log/lin) to dBmA.

Key Path:	AMPTD Y Scale, Y Axis Unit
-----------	-----------------------------------

Example:	UNIT:POW DBMA
Dependencies:	Grayed out if an Amplitude Correction with an Antenna Unit is ON.
Readback:	dBmA
Initial S/W Revision:	Prior to A.02.00
Modified at S/W Revision:	A.02.00
Help Map ID:	3024

W

Sets the amplitude unit for the selected amplitude scale (log/lin) to watt.

Key Path:	AMPTD Y Scale, Y Axis Unit
Example:	UNIT:POW W
Dependencies:	Grayed out if an Amplitude Correction with an Antenna Unit is ON.
Readback:	W
Initial S/W Revision:	Prior to A.02.00
Modified at S/W Revision:	A.02.00
Help Map ID:	3025

V

Sets the amplitude unit for the selected amplitude scale (log/lin) to volt.

Key Path:	AMPTD Y Scale, Y Axis Unit
Example:	UNIT:POW V
Dependencies:	Grayed out if an Amplitude Correction with an Antenna Unit is ON.
Readback:	V
Initial S/W Revision:	Prior to A.02.00
Modified at S/W Revision:	A.02.00
Help Map ID:	3026

A

Sets the amplitude unit for the selected amplitude scale (log/lin) to Ampere.

Key Path:	AMPTD Y Scale, Y Axis Unit
Example:	UNIT:POW A
Dependencies:	Grayed out if an Amplitude Correction with an Antenna Unit is ON.

Common Measurement Functions 1

Readback:	A
Initial S/W Revision:	Prior to A.02.00
Modified at S/W Revision:	A.02.00
Help Map ID:	3027

dBmV

Sets the amplitude unit for the selected amplitude scale (log/lin) to dB μ V.

Key Path:	AMPTD Y Scale, Y Axis Unit
Example:	UNIT:POW DBUV
Dependencies:	Grayed out if an Amplitude Correction with an Antenna Unit is ON.
Readback:	dB μ V
Initial S/W Revision:	Prior to A.02.00
Modified at S/W Revision:	A.02.00
Help Map ID:	3028

dBmA

Sets the amplitude unit for the selected amplitude scale (log/lin) to dB μ A.

NOTE

The unit dBuA can also appear as an Antenna Unit. This will be used by customers using current probes, because current probes are often supplied with conversion tables that provide the transducer factors. When dBuA is used as an Antenna Unit the normal conversion from power to amps for dBuA (based on the analyzer input impedance) is not done, but instead the conversion is based solely on the Correction that contains the transducer factors. This is what distinguishes dBuA as a normal unit from dBuA as an antenna unit. When querying the Y-Axis unit, you can query the Antenna Unit to distinguish between regular dBuA and the dBuA antenna unit. If :CORR:CSET:ANT? returns NOC (for No Conversion), you are using a normal Y Axis dBuA. If it returns UA you are using an Antenna Unit dBuA.

Key Path:	AMPTD Y Scale, Y Axis Unit
Example:	UNIT:POW DBUA
Dependencies:	Grayed out if an Amplitude Correction with an Antenna Unit is ON.
Readback:	dB μ A
Initial S/W Revision:	Prior to A.02.00
Modified at S/W Revision:	A.02.00

Help Map ID:	3029
--------------	------

dBpW

Sets the amplitude unit for the selected amplitude scale (log/lin) to dBpW.

Key Path:	AMPTD Y Scale, Y Axis Unit
Example:	UNIT:POW DBPW
Dependencies:	Grayed out if an Amplitude Correction with an Antenna Unit is ON.
Readback:	dB μ A
Initial S/W Revision:	A.11.00
Help Map ID:	4044

Antenna Unit

When a Correction is turned on that uses an Antenna Unit, the Y Axis Unit changes to that Antenna Unit. All of the keys in the Y-Axis Unit menu are then greyed out, except the Antenna Unit key. The unit being used is shown on this key and is shown as selected in the submenu.

Key Path:	AMPTD Y Scale, Y Axis Unit
Dependencies:	Grayed out if no Amplitude Correction with an Antenna Unit is on.
Readback line:	Currently selected unit
Initial S/W Revision:	A.11.00
Help Map ID:	4004

dBmV/m

Sets the amplitude unit for the selected amplitude scale (log/lin) to dB μ V/m. This is an antenna unit, and this key is grayed out unless a Correction with this Antenna Unit selected is ON. If this is the case, all of the other Antenna Units are grayed out.

Key Path:	AMPTD Y Scale, Y Axis Unit, Antenna Unit
Example:	UNIT:POW DBUVM
Dependencies:	Grayed out if no Amplitude Correction with an Antenna Unit is on.
Readback:	dB μ V/m
Initial S/W Revision:	A.02.00
Help Map ID:	3030

dBmA/m

Sets the amplitude unit for the selected amplitude scale (log/lin) to dB μ A/m. This is an antenna unit, and this key is grayed out unless a Correction with this Antenna Unit selected is ON. If this is the case, all of the other Antenna

Common Measurement Functions 1

Units are grayed out.

Key Path:	AMPTD Y Scale, Y Axis Unit, Antenna Unit
Example:	UNIT:POW DBUAM
Dependencies:	Grayed out if no Amplitude Correction with an Antenna Unit is on.
Readback:	dB μ A/m
Initial S/W Revision:	A.02.00
Help Map ID:	3031

dBmA

Sets the amplitude unit for the selected amplitude scale (log/lin) to dB μ A. This is an antenna unit, and this key is grayed out unless a Correction with this Antenna Unit selected is ON. If this is the case, all of the other Antenna Units are grayed out.

Key Path:	AMPTD Y Scale, Y Axis Unit, Antenna Unit
Example:	UNIT:POW DBUAM
Dependencies:	Grayed out if no Amplitude Correction with an Antenna Unit is on.
Readback:	dB μ A
Initial S/W Revision:	A.11.00
Help Map ID:	4045

dBpT

Sets the amplitude unit for the selected amplitude scale (log/lin) to dBpT. This is an antenna unit, and this key is grayed out unless a Correction with this Antenna Unit selected is ON. If this is the case, all of the other Antenna Units are grayed out.

Key Path:	AMPTD Y Scale, Y Axis Unit, Antenna Unit
Example:	UNIT:POW DBPT
Dependencies:	Grayed out if no Amplitude Correction with an Antenna Unit is on.
Readback:	dBpT
Initial S/W Revision:	A.02.00
Help Map ID:	3032

dBG

Sets the amplitude unit for the selected amplitude scale (log/lin) to dBG. This is an antenna unit, and this key is grayed out unless a Correction with this Antenna Unit selected is ON. If this is the case, all of the other Antenna Units are grayed out.

Key Path:	AMPTD Y Scale, Y Axis Unit, Antenna Unit
-----------	---

Example:	UNIT:POW DBG
Dependencies:	Grayed out if no Amplitude Correction with an Antenna Unit is on.
Readback:	DBG
Initial S/W Revision:	A.02.00
Help Map ID:	3033

None

This is selected if no Antenna Unit is currently on, however you cannot actually set this value, since it is always grayed out. The key is included simply to provide an indication on the Readback line of the Antenna Unit key when there is no Antenna Unit selected.

Key Path:	AMPTD Y Scale, Y Axis Unit, Antenna Unit
Readback:	“None”
Initial S/W Revision:	A.11.00
Help Map ID:	4046

Reference Level Offset

Adds an offset value to the displayed reference level. The reference level is the absolute amplitude represented by the top graticule line on the display.

See [“More Information” on page 1252](#)

Key Path:	AMPTD Y Scale
Mode:	SA
Scope:	Meas Global
Remote Command:	:DISPlay:WINDow[1]:TRACe:Y[:SCALe]:RLEVel:OFFSet <rel_ampl> :DISPlay:WINDow[1]:TRACe:Y[:SCALe]:RLEVel:OFFSet?
Example:	DISP:WIND:TRAC:Y:RLEV:OFFS 12.7 Sets the Ref Level Offset to 12.7 dB. The only valid suffix is dB. If no suffix is sent, dB will be assumed.
Preset:	0 dBm
State Saved:	Saved in instrument state
Min:	The range for Ref Lvl Offset is variable. It is limited to values that keep the reference level within the range of -327.6 dB to 327.6 dB.
Max:	327.6 dB

Common Measurement Functions 1

Backwards Compatibility Notes:	<ol style="list-style-type: none">1. In pre-X-Series instruments, Ref Level Offset could not be adjusted by the knob or step keys. That is no longer the case.2. In ESA and PSA, Ref Level Offset was applied to the data as it was acquired; thus if the Offset changed the new offset was not applied until new trace data was taken. In X-Series, the offset is applied as the data is displayed/queried, so if you change the offset, it will change the data immediately.
Initial S/W Revision:	Prior to A.02.00
Modified at S/W Revision:	A.04.00
Help Map ID:	3034

More Information

Offsets are used when gain or loss occurs between a device under test and the analyzer input. Thus, the signal level measured by the analyzer may be thought of as the level at the input of an external amplitude conversion device. Entering an offset does not affect the trace position or attenuation value, just the value of the top line of the display and the values represented by the trace data. Thus, the values of exported trace data, queried trace data, marker amplitudes, trace data used in calculations such as N dB points, trace math, peak threshold, and so forth, are all affected by Ref Level Offset.

NOTE Changing the offset causes the analyzer to immediately stop the current sweep and prepare to begin a new sweep, but the data will not change until the trace data updates, because the offset is applied to the data as it is taken. If a trace is exported with a nonzero Ref Level Offset, the exported data will contain the trace data with the offset applied.

The maximum reference level available is dependent on the reference level offset. That is, Ref Level - Ref Level Offset must be in the range -170 to $+30$ dBm. For example, the reference level value range can be initially set to values from -170 dBm to 30 dBm with no reference level offset. If the reference level is first set to -20 dBm, then the reference level offset can be set to values of -150 to $+50$ dB.

If the reference level offset is first set to -30 dB, then the reference level can be set to values of -200 dBm to 0 dBm. In this case, the reference level is “clamped” at 0 dBm because the maximum limit of $+30$ dBm is reached with a reference level setting of 0 dBm with an offset of -30 dB. If instead, the reference level offset is first set to 30 dB, then the reference level can be set to values of -140 to $+60$ dBm.

μ W Path Control

The **μ W Path Control** functions include the **μ W Preselector Bypass** (Option MPB) and **Low Noise Path** (Option LNP) controls in the High Band path circuits.

When the μ W Preselector is bypassed, the user has better flatness, but will be subject to spurs from out of band interfering signals. When the Low Noise Path is enabled, the analyzer automatically switches around certain circuitry in the high frequency bands which can contribute to noise, when it is appropriate based on other analyzer settings.

For most applications, the preset state is Standard Path, which gives the best remote-control throughput,

minimizes acoustic noise from switching and minimizes the risk of wear out in the hardware switches. For applications that utilize the wideband IF paths, the preset state is the μ W Preselector Bypass path, if option MPB is present. This is because, when using a wideband IF such as the 140 MHz IF, the μ W Preselector’s bandwidth can be narrower than the available IF bandwidth, causing degraded amplitude flatness and phase linearity, so it is desirable to bypass the preselector in the default case.

Users may choose Low Noise Path Enable. It gives a lower noise floor, especially in the 21–26.5 GHz region, though without improving many measures of dynamic range, and without giving the best possible noise floor. The preamp, if purchased and used, gives better noise floor than does the Low Noise Path, however its compression threshold and third-order intercept are much poorer than that of the non-preamp Low Noise Path. There are some applications, typically for signals around 30 dBm, for which the third-order dynamic range of the standard path is good enough, but the noise floor is not low enough even with 0 dB input attenuation. When the third-order dynamic range of the preamp path is too little and the noise floor of the standard path is too high, the Low Noise Path can provide the best dynamic range.

Key Path:	AMPTD Y Scale
Mode:	SA, BASIC, PNOISE, VSA , LTE, LTETDD
Scope:	Meas Global
Remote Command:	[:SENSE] :POWER [:RF] :MW:PATH STD LNPath MPBypass FULL [:SENSe] :POWER [:RF] :MW:PATH?
Example:	:POW:MW:PATH LNP Enables the Low Noise path
Notes:	If a Presel Center is performed, the analyzer will momentarily switch to the Standard Path, regardless of the setting of μW Path Control The DC Block will always be switched in when the low noise path is switched in, to protect succeeding circuitry from DC. Note that this does not mean “when the low noise path is enabled” but when, based on the Low Noise Path rules, the path is actually switched in. This can happen when the selection is Low Noise Path Enable . In the case where the DC Block is switched in the analyzer is now AC coupled. However, if the user has selected DC coupling, the UI will still behave as though it were DC coupled, including all annunciation, warnings, status bits, and responses to SCPI queries. This is because, based on other settings, the analyzer could switch out the low noise path at any time and hence go back to being DC coupled. Alignment switching ignores the settings in this menu, and restores them when finished.
Dependencies:	Unavailable in BBIQ and External Mixing
Preset:	All modes other than IQ Analyzer mode and VXA: STD IQ Analyzer, VXA and WLAN mode: MPB option present and licensed: MPB MPB option not present and licensed: STD
State Saved:	Save in instrument state
Readback:	Value selected in the submenu

Common Measurement Functions 1

Initial S/W Revision:	A.04.00
Modified at S/W Revision:	A.10.00
Help Map ID:	4027

Standard Path

This path gives the best remote-control throughput, minimizes acoustic noise from switching and minimizes the risk of wear in the hardware switches, particularly in remote test scenarios where both low band and high band setups will follow in rapid succession.

In this path, the bypass of the low band/high band switch and microwave preamp is never activated, which can cause some noise degradation but preserves the life of the bypass switch.

Key Path:	AMPTD Y Scale, μW Path Control
Example:	:POW:MW:PATH STD
Readback Text:	Standard Path
Initial S/W Revision:	A.04.00
Help Map ID:	4028

Low Noise Path Enable

You may choose Low Noise Path Enable, which gives a lower noise floor under some circumstances, particularly when operating in the 21–26.5 GHz region. With the Low Noise Path enabled, the low band/high band switch and microwave preamp are bypassed whenever all of the following are true:

- The analyzer is not in the Low Band, meaning:
 - the start frequency is above 3.5 GHz and
 - the stop frequency is above 3.6 GHz.
- the internal preamp is not installed or (if installed) is set to **Off** or **Low Band**

Note that this means that, when any part of a sweep is done in Low Band, the Low Noise Path is not used, whether or not the **Low Noise Path Enable** is selected in the user interface. Also, if the preamp is turned on, the Low Noise Path is not used, whether or not the **Low Noise Path Enable** is selected in the user interface. The only time the Low Noise Path is used is when **Low Noise Path Enable** is selected, the sweep is completely in High Band (> 3.6 GHz) and no preamp is in use.

See [“More Information” on page 1255](#)

Key Path:	AMPTD Y Scale, μW Path Control
Measurement:	Swept SA
Example:	:POW:MW:PATH LNP

Notes:	<p>For measurements that use IQ acquisition, the low noise path is used when the Center Frequency is in High Band (> 3.6 GHz) and no preamp is in use.</p> <p>In other words, the rules above are modified to use only the center frequency to qualify which path to switch in.</p> <p>This is not the case for FFT's in the Swept SA measurement; they use the same rules as swept measurements.</p>
Dependencies:	<p>Key is blanked if current mode does not support it.</p> <p>Key is grayed out if mode supports it but current measurement does not support it.</p> <p>Unless Option LNP is present and licensed, key is blank and if SCPI command sent, error -241, "Hardware missing; Option not installed" is generated.</p>
Readback Text:	Low Noise Path Enable
Initial S/W Revision:	A.04.00
Help Map ID:	4029

More Information

The user should understand that the Low Noise Path, while giving improved DANL, has the disadvantage of decreased TOI performance and decreased gain compression performance relative to the standard path.

The user should also understand that the bypass switch is a mechanical switch and has finite life, so if the **Low Noise Path** is enabled, it is possible to cause frequent cycling of this switch by frequently changing analyzer settings such that the above conditions hold true only some of the time. A user making tests of this nature should consider opting for the **Standard Path**, which will never throw the bypass switch, at the expense of some degraded noise performance.

The low noise path is useful for situations where the signal level is so low that the analyzer performance is dominated by noise even with 0 dB attenuation, but still high enough that the preamp option would have excessive third-order intermodulation or compression. The preamp, if purchased and used, gives better noise floor than does the "Low Noise Path." However, its compression threshold and third-order intercept are much poorer than that of the non-preamp path. There are some applications, typically for signals around 30 dBm, for which the third-order dynamic range of the standard path is good enough, but the noise floor is not low enough even with 0 dB input attenuation. When the third-order dynamic range of the preamp path is too little and the noise floor of the standard path is too high, the Low Noise Path can provide the best dynamic range

The graph below illustrates the concept. It shows, in red, the performance of an analyzer at different attenuation settings, both with the preamp on and off, in a measurement that is affected by both analyzer noise and analyzer TOI. The green shows the best available dynamic range, offset by 0.5 dB for clarity. The blue shows how the best available dynamic range improves for moderate signal levels with the low noise path switched in. In this illustration, the preamp improves the noise floor by 15 dB while degrading the third-order intercept by 30 dB, and the low noise path reduces loss by 8 dB. The attenuator step size is 2 dB.

Common Measurement Functions 1

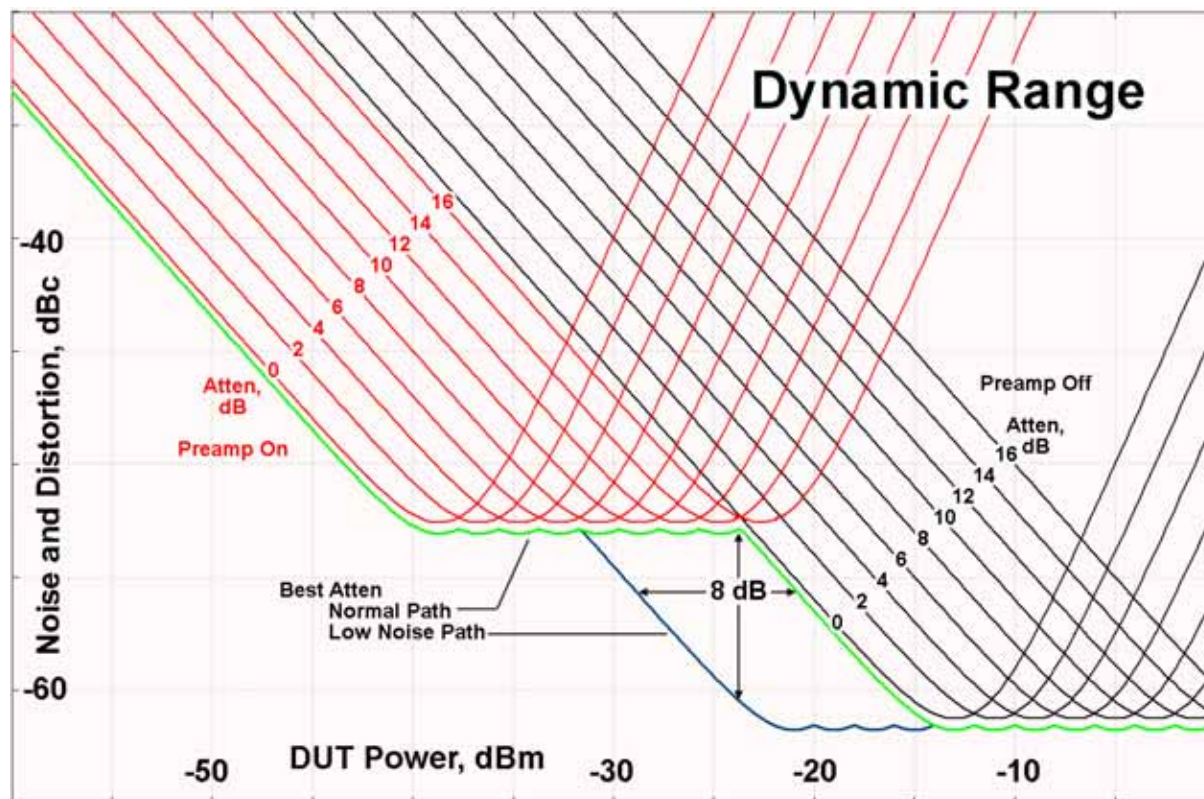

There are other times where selecting the low noise path improves performance, too. Compression-limited measurements such as finding the nulls in a pulsed-RF spectrum can profit from the low noise path in a way similar to the TOI-limited measurement illustrated. Accuracy can be improved when the low noise path allows the optimum attenuation to increase from a small amount like 0, 2 or 4 dB to a larger amount, giving better return loss at the analyzer input. Harmonic measurements, such as second and third harmonic levels, are much improved using the low noise path because of the superiority of that path for harmonic (though not intermodulation) distortion performance.

μW Preselector Bypass

This key toggles the preselector bypass switch for band 1 and higher. When the microwave preselector is on, the signal path is preselected. When the microwave preselector is off, the signal path is not preselected. The preselected path is the normal path for the analyzer.

The preselector is a tunable bandpass filter which prevents signals away from the frequency of interest from combining in the mixer to generate in-band spurious signals (images). The consequences of using a preselector filter are its limited bandwidth, the amplitude and phase ripple in its passband, and any amplitude and phase instability due to center frequency drift.

Option MPB or pre-selector bypass provides an unpreselected input mixer path for certain X-Series signal analyzers with frequency ranges above 3.6 GHz. This signal path allows a wider bandwidth and less amplitude variability, which is an advantage when doing modulation analysis and broadband signal analysis. The disadvantage is that, without the preselector, image signals will be displayed. Another disadvantage of bypassing the preselector is increased LO emission levels at the front panel input port.

Key Path:	AMPTD Y Scale, μW Path Control
-----------	--------------------------------

Example:	:POW:MW:PATH MPB
Dependencies:	Key is blanked if current mode does not support it. Key is grayed out if mode supports it but current measurement does not support it. Key is blank unless Option MPB is present and licensed. If SCPI command sent when MPB not present, error -241, "Hardware missing; Option not installed" is generated.
Readback Text:	μW Preselector Bypass
Initial S/W Revision:	A.04.00
Help Map ID:	4030

Remote Command:	[:SENSe] :POWer [:RF] :MW:PRESelector [:STATe] ON OFF 0 1 [:SENSe] :POWer [:RF] :MW:PRESelector [:STATe] ?
Example:	:POW:MW:PRES OFF Bypasses the microwave preselector
Notes:	The ON parameter sets the STD path (:POW:MW:PATH STD) The OFF parameter sets path MPB (:POW:MW:PATH MPB)
Preset:	ON
Help Map ID:	0

Internal Preamp

Accesses a menu of keys that control the internal preamps. Turning on the preamp gives a better noise figure, but a poorer TOI to noise floor dynamic range. You can optimize this setting for your particular measurement.

The instrument takes the preamp gain into account as it sweeps. If you sweep outside of the range of the preamp the instrument will also account for that. The displayed result will always reflect the correct gain.

Key Path:	AMPTD Y Scale
Scope:	Meas Global
Remote Command:	[:SENSe] :POWer [:RF] :GAIN [:STATe] OFF ON 0 1 [:SENSe] :POWer [:RF] :GAIN [:STATe] ?
Dependencies:	Preamp is not available on all hardware platforms. If the preamp is not present or is unlicensed, the key is not shown. The preamp is not available when the electronic/soft attenuator is enabled. Preamp controls and settings are not available on the E6607C. If any preamp commands are sent to the E6607C the following error will be generated: -241;Hardware missing; not available for this model number

Common Measurement Functions 1

Preset:	OFF
State Saved:	Saved in instrument state
Initial S/W Revision:	Prior to A.02.00
Help Map ID:	3036

Key Path:	AMPTD Y Scale, Internal Preamp
Scope:	Meas Global
Remote Command:	[:SENSE] :POWER[:RF] :GAIN:BAND LOW FULL [:SENSE] :POWER[:RF] :GAIN:BAND?
Dependencies:	Preamp is not available on all hardware platforms. If the preamp is not present or is unlicensed, the key is not shown. If a POW:GAIN:BAND FULL command is sent when a low band preamp is available, the preamp band parameter is to LOW instead of FULL, and an "Option not installed" message is generated.
Preset:	LOW
State Saved:	Saved in instrument state
Initial S/W Revision:	Prior to A.02.00
Help Map ID:	0

Off

Turns the internal preamp off

Key Path:	AMPTD Y Scale, Internal Preamp
Example:	:POW:GAIN OFF
Readback:	Off
Initial S/W Revision:	Prior to A.02.00
Help Map ID:	3038

Low Band

Sets the internal preamp to use only the low band.

The frequency range of the installed (optional) low-band preamp is displayed in square brackets on the **Low Band** key label.

Key Path:	AMPTD Y Scale, Internal Preamp
Example:	:POW:GAIN ON :POW:GAIN:BAND LOW

Readback:	Low Band
Initial S/W Revision:	Prior to A.02.00
Help Map ID:	3039

Full Range

Sets the internal preamp to use its full range. The low band (0–3.6 GHz or 0–3GHz, depending on the model) is supplied by the low band preamp and the frequencies above low band are supplied by the high band preamp.

The frequency range of the installed (optional) preamp is displayed in square brackets on the Full Range key label. If the high band option is not installed the Full Range key does not appear.

Key Path:	AMPTD Y Scale, Internal Preamp
Example:	:POW:GAIN ON :POW:GAIN:BAND FULL
Readback:	Full Range
Initial S/W Revision:	Prior to A.02.00
Help Map ID:	3040

Auto Couple

The Auto Couple feature provides a quick and convenient way to automatically couple multiple test set settings. This helps ensure accurate measurements and optimum dynamic range. When the Auto Couple feature is activated, either from the front panel or remotely, all parameters of the current measurement which have an Auto/Manual mode are set to Auto mode and all measurement settings dependent on (or coupled to) the Auto/Man parameters are automatically adjusted for optimal performance.

The Auto Couple key actions are confined to the current measurement only. It does not affect other measurements in the mode, and it does not affect markers, marker functions, trace attributes, or display attributes.

See [“More Information” on page 1260](#)

Key Path	Front-panel key
Remote Command	:COUPLe ALL NONE
Example	:COUP ALL
Notes	:COUPLe ALL puts all Auto/Man parameters in Auto mode (equivalent to pressing the Auto Couple key). :COUPLE NONE puts all Auto/Man parameters in manual mode. It decouples all the coupled test set parameters and is not recommended for making measurements.
Initial S/W Revision	Prior to A.02.00

Common Measurement Functions 1

Help Map ID

3041

More Information

There are two types of functions that have Auto/Manual modes.

Auto/Man Active Function keys

An Auto/Man toggle key controls the binary state associated with an test set parameter by toggling between "Auto" (where the parameter is automatically coupled to the other parameters it is dependent upon) and "Man" (where the parameter is controlled independent of the other parameters), as well as making the parameter the active function. The current mode is indicated on the key with either "Auto" or "Man" underlined as illustrated below.

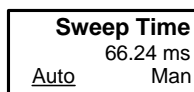

vsd07

Auto/Man 1-of-N keys

An Auto/Man 1-of-N key allows you to manually pick from a list of parameter values, or place the function in "Auto" in which case the value is automatically selected (and indicated) as shown below. If in Auto, Auto is underlined on the calling key. If in manual operation, manual is indicated on the calling key. But the calling key does not actually toggle the function, it simply opens the menu.

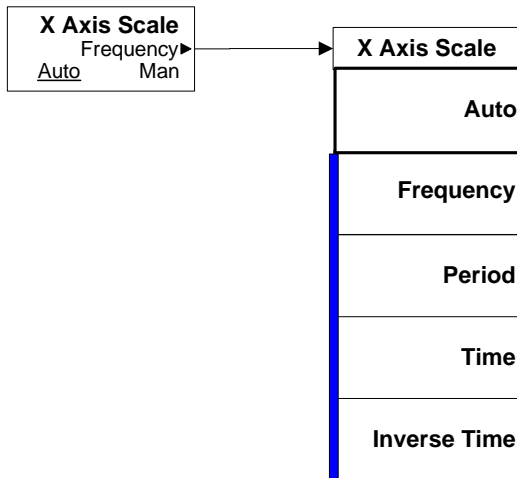

vsd08

BW

The BW key opens the bandwidth menu, which contains keys to control the Resolution Bandwidth and Video Bandwidth functions of the test set.

The Res BW functions control filter bandwidth and filter type. There are two filter types, Gaussian and Flattop. The Gaussian filters have a response curve that is parabolic on a log scale. The Flattop filter shape is a close approximation of a rectangular filter.

NOTE The AVERAGE functions are found in the Trace menu and the Meas Setup menu. In the Trace menu, you may turn Trace Averaging on or off for the desired traces (rather than globally as in the past); and in the Meas Setup menu you may configure Averaging, by setting the Average Number and the Average Type.

Key Path	Front-panel key
Initial S/W Revision	Prior to A.02.00
Help Map ID	3042

Res BW

Activates the resolution bandwidth active function, which allows you to manually set the resolution bandwidth (RBW) of the test set. Normally, **Res BW** (Auto) selects automatic coupling of the Res BW to **Span** using the ratio set by the Span:3dB RBW key. To decouple the resolution bandwidth, press Res BW until Man is underlined, or simply enter a different value for **Res BW**.

See “More Information” on page 1262

Key Path	BW
Remote Command	[:SENSE]:BANDwidth BWIDth[:RESolution] <freq> [:SENSE]:BANDwidth BWIDth[:RESolution]? [:SENSE]:BANDwidth BWIDth[:RESolution]:AUTO OFF ON 0 1 [:SENSE]:BANDwidth BWIDth[:RESolution]:AUTO?
Example	BAND 1 KHZ BAND? BWID:AUTO ON BWID:AUTO?
Notes	For numeric entries, all RBW Types choose the nearest (arithmetically, on a linear scale, rounding up) available RBW to the value entered.
Notes	The setting and querying of values depends on the current bandwidth type.
Dependencies	When in Zero Span with no EMI Standard selected, there is no Auto setting for Res BW. The Auto/Man line on the Res BW key disappears in this case, and if the SCPI command [:SENSe]:BWID[:RESolution]:AUTO ON is sent, it generates an error.

Common Measurement Functions 1

Couplings	<p>Res BW is normally coupled to Span; if Res BW is set to Auto, as the Span decreases, so will the Res BW. Normally, in Zero Span, this coupling is turned off and Res BW has no Auto setting.</p> <p>When a CISPR or MIL EMI Standard is in use, the Res BW is coupled to Center Frequency and not to Span, and this is true even in Zero Span.</p> <p>Sweep time is coupled to RBW when in a non-zero span. If Sweep Time is set to Auto, then the sweep time is changed as the RBW changes, to maintain amplitude calibration.</p> <p>Video bandwidth (VBW) is normally coupled to RBW. If VBW is set to Auto, then the VBW is changed as the RBW changes, to maintain the ratio set by VBW:3dB RBW. See the ““VBW:3dB RBW” on page 1264” key description.</p>
Preset	<p>3 MHz</p> <p>ON</p>
State Saved	Saved in Instrument State
Min	1 Hz
Max	8 MHz is the max equivalent –3 dB RBW, which means that the named RBW (the one shown on the key) can actually exceed 8 MHz if using a filter other than –3 dB Gaussian
Default Unit	Hz
Initial S/W Revision	Prior to A.02.00
Help Map ID	3043

More Information

When the **Res BW** is manually selected, it may be returned to the coupled state by pressing the **Res BW** key until **Auto** is underlined. This may also be done by pressing Auto Couple or by performing a **Preset**.

When **Res BW** is set to **Auto**, the bandwidth selected depends on the Filter Type (see “Filter Type” below).

Only certain discrete resolution bandwidths are available. The available bandwidths are dependent on the **Filter Type** or the **EMC Standard**. If an unavailable bandwidth is entered with the numeric keypad, the closest available bandwidth is selected.

The zero-span case deserves some mention, because RBW is coupled to Span when in a swept (non-zero) span and in zero span there is normally no meaningful RBW coupling in Zero Span. However, when a MIL or CISPR EMC Standard is selected, there IS a meaningful coupling for RBW in Zero Span – in fact, it is coupled to Center Frequency, in order to make measurements according to the EMI specifications.

The annotation under RBW in the bottom left of the screen shows the type of filter or bandwidth that is being used. The following examples illustrate this:

–3 dB (Normal) filter BW:Res BW 300 Hz

–6 dB filter BW: Res BW (–6 dB) 422 Hz

Noise filter BW: Res BW (Noise) 317 Hz

Impulse filter BW: Res BW (Impulse) 444 Hz

CISPR filter BW:Res BW (CISPR) 200 Hz

MIL filter BW:Res BW (MIL) 1 kHz

Flattop filter type:Res BW (Flattop) 300 Hz

Video BW

Lets you change the test set post-detection filter (VBW) from 1 Hz to 8 MHz in approximately 10% steps. In addition, a wide-open video filter bandwidth may be chosen by selecting 50 MHz.

Normally, Video BW (Auto) selects automatic coupling of the Video BW filter to the resolution bandwidth filter using the ratio set by the VBW:3dB RBW key. To decouple the video bandwidth, press Video BW until Man is underlined, or simply enter a new value.

When the **Video BW** is manually selected, it may be returned to the coupled state by pressing the **Video BW** key until **Auto** is underlined. This may also be done by pressing Auto Couple or by performing a **Preset**.

Key Path	BW
Remote Command	[:SENSe]:BANDwidth BWIDth:VIDeo <freq> [:SENSe]:BANDwidth BWIDth:VIDeo? [:SENSe]:BANDwidth BWIDth:VIDeo:AUTO OFF ON 0 1 [:SENSe]:BANDwidth BWIDth:VIDeo:AUTO?
Example	BAND:VID 1 KHZ BAND:VID? BWID:VID:AUTO ON BWID:VID:AUTO?
Notes	For numeric entries, the test set chooses the nearest (arithmetically, on a linear scale, rounding up) available VBW to the value entered. The 50 MHz VBW is defined to mean “wide open”.
Notes	The values shown in this table reflect the conditions after a Mode Preset.
Dependencies	Sometimes the displayed Video BW is not actually used to process the trace data: <ul style="list-style-type: none"> • When the Average Detector is selected and Sweep Type is set to Swept, the video bandwidth filter cannot be used, because it uses the same hardware as the Average Detector. • When the Quasi-Peak, EMI Average or RMS Average detector is selected the VBW is implemented by the digital IF as part of the detector <p>When this is the case, the VBW still acts to change the Sweep Time, if Sweep Time is in Auto, and still affects the data on other traces for which this is not the case.</p>

Common Measurement Functions 1

Preset	3 MHz ON
State Saved	Saved in Instrument State
Min	1 Hz
Max	50 MHz
Default Unit	Hz
Initial S/W Revision	Prior to A.02.00
Modified at S/W Revision	A.02.00
Help Map ID	3044

VBW:3dB RBW

Selects the ratio between the video bandwidth and the equivalent 3 dB resolution bandwidth to be used for setting VBW when VBW is in Auto.

VBW:3dB RBW (Auto) selects automatic coupling of the VBW:3 dB RBW ratio to **Detector**. See [“Coupling Auto Rules:” on page 1265](#) for more information. To decouple the ratio, press VBW:3 dB RBW until Man is underlined, or simply enter a new value.

When the VBW:3dB RBW is manually selected, it may be returned to the coupled state by pressing the VBW:3 dB RBW key until **Auto** is underlined. This may also be done by pressing Auto Couple or by performing a **Preset**.

Key Path	BW
Remote Command	[:SENSE] :BANDwidth BWIDth:VIDeo:RATio <real> [:SENSE] :BANDwidth BWIDth:VIDeo:RATio? [:SENSE] :BANDwidth BWIDth:VIDeo:RATio:AUTO OFF ON 0 1 [:SENSE] :BANDwidth BWIDth:VIDeo:RATio:AUTO?
Example	BAND:VID:RAT 2 BAND:VID:RAT? BAND:VID:RAT:AUTO 0 BAND:VID:RAT:AUTO?
Notes	The values shown in this table reflect the conditions after a Mode Preset.
Couplings	See “Coupling Auto Rules:” on page 1265
Preset	1 ON
State Saved	Saved in Instrument State
Min	0.00001

Max	3000000
Initial S/W Revision	Prior to A.02.00
Modified at S/W Revision	A.02.00
Help Map ID	3045

Coupling Auto Rules:

The Auto Rules for the **VBW:3dB RBW** function are as follows:

First, we go through the following list and find the lowest numbered detector being used on any active traces (traces for which Update is On):

Peak

Normal

Average

Sample

Negative Peak

EMI Average

Quasi Peak

RMS Average

Use that detector to pick the ratio based on the following criteria:

1. If the detector is Peak and the EMC Standard is set to either CISPR or MIL, use 10.0 (we use wide VBWs to capture peak levels accurately).
2. Otherwise, if the detector is **Negative Peak**, use 1.0 (in the Negative Peak case, there are no known significant use models so we use a medium ratio).
3. Otherwise, if the detector is **Normal**, use 1.0.
4. Otherwise, if the detector is **Average**, and the span is nonzero, use 0.1. The use of a small ratio in Average detection is desirable because of its effect on the sweep time equations. The VBW filter is not actually in-circuit when the average detector is on. If the detector is Average, and the span is zero, use 10.0, which gives optimal behavior for Interval Markers in zero span.
5. Otherwise, if the detector is EMI Average, Quasi Peak or CISPR RMS, use 1.0. In fact this is a “don’t care” since no VBW is used for these detectors, as noted under “Dependencies” for the VBW key.
6. Otherwise, the detector is simply **Peak** or **Sample**. These two detectors can use the same rules. In these cases, if any active trace is in max hold or min hold, use 10.0, because Max and Min Hold operations are usually intended to capture peaks and pits without smoothing from the VBW filter; otherwise, use 1.0 as a compromise, because you have not set the test set in a way that implies that you are measuring noise, pulsed-RF or CW signals.

Note that because the above couplings depend on which traces are active, they are re-examined whenever any trace goes active or inactive, except when this leaves no traces active. Transitioning to the state where no traces are active should not affect the couplings; in that way, the annotation will always

Common Measurement Functions 1

reflect the state of the last trace which was active.

Span:3dB RBW

Selects the ratio between span and resolution bandwidth.

Normally, Span:3dB RBW (Auto) selects a Span:3dB RBW ratio of 106:1. If you manually enter the ratio, Man becomes underlined, which enables you to manually select ratios more suitable for certain measurements.

When the Span:3dB RBW is manually selected, it may be returned to the coupled state by pressing the Span:3dB RBW key until **Auto** is underlined. This may also be done by pressing Auto Couple or by performing a **Preset**.

Key Path	BW
Remote Command	<pre>[:SENSe] :FREQuency:SPAN:BANDwidth[:RESolution] :RATio <integer> [:SENSe] :FREQuency:SPAN:BANDwidth[:RESolution] :RATio? [:SENSe] :FREQuency:SPAN:BANDwidth[:RESolution] :RATio:AUTO OFF ON 0 1 [:SENSe] :FREQuency:SPAN:BANDwidth[:RESolution] :RATio:AUTO?</pre>
Example	<pre>FREQ:SPAN:BAND:RAT 200 sets a ratio of 200:1, and turns off the auto coupling. FREQ:SPAN:BAND:RAT:AUTO ON FREQ:SPAN:BAND:RAT?</pre>
Notes	The values shown in this table reflect the conditions after a Mode Preset.
Dependencies	<p>Grayed out when the EMC Standard is set to CISPR or MIL, since RBW is coupled to Center Frequency rather than Span in this case.</p> <p>If the grayed out key is pressed, an advisory message is generated. If the equivalent SCPI command is sent, the command is acted upon, but it doesn't affect the current measurement.</p>
Preset	<pre>106 ON</pre>
State Saved	Saved in Instrument State
Min	2
Max	10000
Initial S/W Revision	Prior to A.02.00
Help Map ID	3046

RBW Control

Selects the type/shape for the resolution bandwidth filters. Historically, the Res BW filters in Agilent

Test Sets were Gaussian filters, specified using the –3 dB bandwidth of the filter. That is, a 10 MHz Res BW filter was a Gaussian shape with its –3 dB points 10 MHz apart. In the X-Series you can, using the **Filter BW** key, specify bandwidths other than the –3 dB bandwidth (–6 dB, Noise, Impulse) for the width of the Gaussian filters. Furthermore, the **Filter BW** menu lets you choose between a Gaussian and Flat Top filter shape, for varying measurement conditions.

Key Path	BW
Dependencies]The RBW Control key is grayed out if the EMC Standard is set to CISPR or MIL . In this case the Filter Type is always Gaussian; the Filter BW is chosen as appropriate for the filter and the standard.
Readback line	[<filter type>] or, if Filter Type is Gaussian, [Gaussian,<filter BW>]
Initial S/W Revision	Prior to A.02.00
Modified at S/W Revision	A.02.00
Help Map ID	3047

Filter Type

Besides the familiar Gaussian filter shape, there are certain special filter types, such as Flat Top, that are desirable under certain conditions. The **Filter Type** menu gives you control over these types.

See “[More Information](#)” on page 1267

Key Path	BW, RBW Control
Remote Command	[:SENSE] :BANDwidth BWIDth :SHAPE GAUSSian FLATtop [:SENSE] :BANDwidth BWIDth :SHAPE ?
Example	BAND:SHAP GAUS
Notes	GAUSSian = Gaussian FLATtop = Flattop
Dependencies	When EMC Standard is set to CISPR or MIL , the Filter Type is always Gaussian
Preset	Auto Couple chooses the preset value
State Saved	Saved in State
Readback line	1-of-N selection
Initial S/W Revision	Prior to A.02.00
Modified at S/W Revision	A.02.00
Help Map ID	3048

More Information

Gaussian filters

Common Measurement Functions 1

When the Gaussian filter type is chosen, a set of 160 RBW filters are available whose shape is approximately Gaussian. The actual bandwidths used to realize the X-Series's Gaussian filters are chosen to come as close as possible to a 24 step per decade series, within the limitations of the digital IF.

For Gaussian filters, the annotation at the bottom of the screen shows the filter bandwidth type (unless it is Normal). This is shown parenthetically between the words "Res BW" and the value, for example

Res BW 10.0 Hz (Normal bandwidth)

Res BW (Impulse) 14.8 Hz (Impulse bandwidth)

Flattop filters

When the Flattop filter type is chosen, a new set of 134 RBW hardware settings are available. These settings realize filters that are approximately rectangular in shape. When this shape is chosen the filter bandwidth options are irrelevant and therefore unavailable.

The annotation at the bottom of the screen will show that the Flattop shape is being used, for example:

Res BW (Flattop) 10 Hz

Gaussian

Selects the Gaussian filter type. There are 160 of these RBWs. They are arranged in a 24-per-decade sequence from 1 Hz through 3 MHz, plus the 4, 5, 6 and 8 MHz settings.

Key Path	BW, RBW Control, Filter Type
Example	BAND:SHAP GAUS
Notes	Parameter is GAUSSian. See remote command in section " Filter Type " on page 1267 .
Readback	Gaussian
Initial S/W Revision	Prior to A.02.00
Help Map ID	3049

Flattop

Selects the flat top filter type

Key Path	BW, RBW Control, Filter Type
Example	BAND:SHAP FLAT
Readback	Flattop
Initial S/W Revision	Prior to A.02.00
Help Map ID	3050

Filter BW

When using the Gaussian filters for certain types of applications it can be useful to be able to specify the filter width using points other than the -3 dB points. The Filter BW function allows you to pick the filter based on its -3 dB (Normal) bandwidth, its -6 dB bandwidth, its Noise bandwidth, or its Impulse

bandwidth. Note that in all four cases the -3 dB bandwidth is the same. The filter does not change, but the way you specify it changes.

See “More Information” on page 1269

Key Path	BW, RBW Control
Remote Command	[:SENSe] :BANDwidth BWIDth:TYPE DB3 DB6 IMPulse NOISe [:SENSe] :BANDwidth BWIDth:TYPE?
Example	BAND:TYPE NOIS
Notes	DB3 = -3 dB (Normal) DB6 = -6 dB IMPulse = Impulse NOISe = Noise
Dependencies	Grayed out if the Flattop filter type is selected. When EMC Standard is set to CISPR or MIL , the Filter BW is chosen as appropriate for the filter and the standard.
Preset	Auto Couple chooses the preset value
State Saved	Saved in State
Readback line	1-of-N selection
Initial S/W Revision	Prior to A.02.00
Modified at S/W Revision	A.02.00
Help Map ID	3052

More Information

The test set provides four ways of specifying the bandwidth of a Gaussian filter:

The -3 dB bandwidth of the filter

The -6 dB bandwidth of the filter

The equivalent Noise bandwidth of the filter, which is defined as the bandwidth of a rectangular filter with the same peak gain which would pass the same power for noise signals.

The equivalent Impulse bandwidth of the filter, which is defined as the bandwidth of a rectangular filter with the same peak gain which would pass the same power for impulsive (narrow pulsed) signals.

The figure below shows the relationships of the various filter bandwidths for filters with the X-Series' shape factor (shape factor is defined as the ratio of the -60 dB bandwidth to the -3 dB bandwidth):

Common Measurement Functions 1

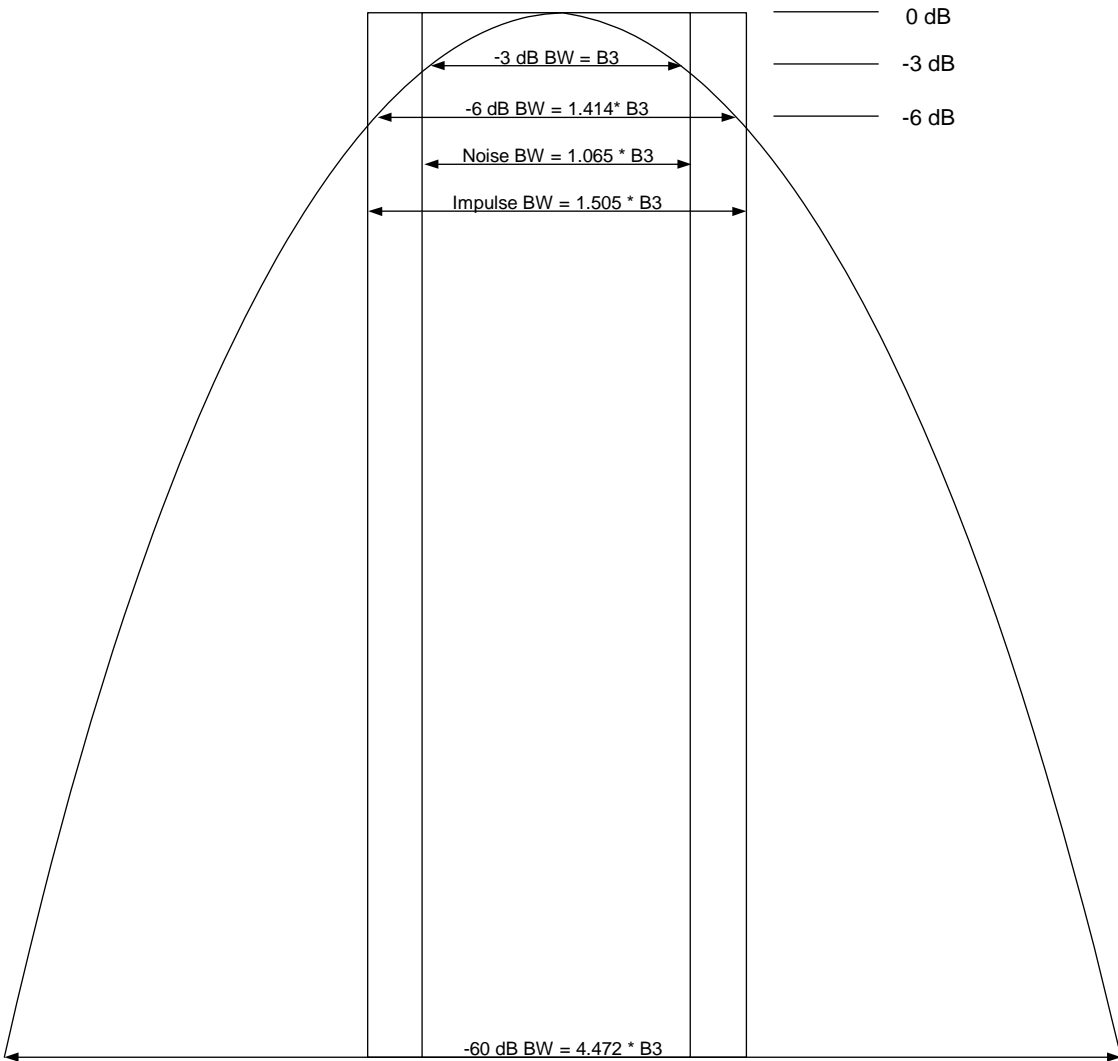

The Filter Type menu lets you choose the filter bandwidth (-3 dB , -6 dB , Noise or Impulse) that is used when specifying the width of the filter. Note that for a given Gaussian filter, changing the filter bandwidth specification does not affect the filter width at all but only the means of specifying it. For example, the filter whose -3 dB bandwidth is 1.0 kHz is the same as the filter whose -6 dB bandwidth is 1.41 kHz , whose Noise bandwidth is 1.06 kHz , and whose Impulse bandwidth is 1.48 kHz . As you cycle through these various filter bandwidths the filter does not change, but the way the filter is annotated and the value which appears in the active function area and on the key does.

-3 dB (Normal)

Selects the normal gaussian-shaped bandwidths that are defined by their -3 dB bandwidths.

Key Path	BW, RBW Control, Filter BW
Example	BAND:TYPE DB3
Readback	-3 dB
Initial S/W Revision	Prior to A.02.00

Help Map ID	3053
-------------	------

-6 dB

Selects the filter bandwidths where the bandwidth is defined at the -6 dB points. This uses the normal RBW filters, but the value displayed on the key, active function line and screen annotation changes to reflect the -6 dB bandwidth instead of the -3 dB bandwidth.

Key Path	BW, RBW Control, Filter BW
Example	BAND:TYPE DB6
Readback	-6 dB
Initial S/W Revision	Prior to A.02.00

Help Map ID	3054
-------------	------

Noise

Selects the noise filter bandwidths. This uses the normal RBW filters, but the value displayed on the key, active function line and screen annotation changes to reflect the equivalent noise bandwidth, instead of the -3 dB bandwidth.

Key Path	BW, RBW Control, Filter BW
Example	BAND:TYPE NOIS
Readback	Noise
Initial S/W Revision	Prior to A.02.00

Help Map ID	3055
-------------	------

Impulse

Selects the impulse bandwidths. This uses the normal RBW filters, but the value displayed on the key, active function line and screen annotation changes to reflect the equivalent impulse bandwidth instead of the -3 dB bandwidth.

Key Path	BW, RBW Control, Filter BW
Example	BAND:TYPE IMP
Readback	Impulse
Initial S/W Revision	Prior to A.02.00

Help Map ID	3056
-------------	------

Cont (Continuous Measurement/Sweep)

Sets the test set for Continuous measurement operation. The single/continuous state is Meas Global so

Common Measurement Functions 1

the setting will affect all measurements. If you are Paused, pressing **Cont** does a Resume.

Key Path:	Front-panel key
Remote Command:	:INITiate:CONTinuous OFF ON 0 1 :INITiate:CONTinuous?
Example:	:INIT:CONT 0 puts the test set in Single measurement operation. :INIT:CONT 1 puts the test set in Continuous measurement operation
Preset:	ON (Note that SYST:PRESet sets INIT:CONT to ON but *RST sets INIT:CONT to OFF)
State Saved:	Saved in instrument state
Backwards Compatibility Notes:	For Spectrum Analysis mode in ESA and PSA, there is no Cont hardkey, instead there is a Sweep Single/Cont key. In these analyzers, switching the Sweep Single/Cont key from Single to Cont restarts averages (displayed average count reset to 1), but does not restart Max Hold and Min Hold . The X-Series has Single and Cont hardkeys in place of the Sweep Single Cont softkey. In the X-Series, if in single measurement, the Cont hardkey (and INIT:CONT ON) switches to continuous measurement, but never restarts a measurement and never resets a sweep.
Initial S/W Revision:	Prior to A.02.00
Help Map ID:	3309

With **Avg/Hold Num** (in the **Meas Setup** menu) set to **Off** or set to **On** with a value of 1, a sweep is taken after the trigger condition is met; and the test set continues to take new sweeps after the current sweep has completed and the trigger condition is again met. However, with **Avg/Hold Num** set to On with a value >1, multiple sweeps (data acquisitions) are taken for the measurement. The trigger condition must be met prior to each sweep. The sweep is not stopped when the average count k equals the number N set for Avg/Hold Num is reached, but the number k stops incrementing. A measurement average usually applies to all traces, marker results, and numeric results. But sometimes it only applies to the numeric results.

If the test set is in Single measurement, pressing the **Cont** key does not change k and does not cause the sweep to be reset; the only action is to put the test set into Continuous measurement operation.

If it is already in continuous sweep:

the INIT:CONT 1 command has no effect

the INIT:CONT 0 command will place the test set in Single Sweep but will have no effect on the current sequence until k = N, at which point the current sequence will stop and the instrument will go to the idle state.

FREQ Channel

Accesses a menu of keys that allow you to control the Frequency and Channel parameters of the

instrument.

Some features in the Frequency menu are the same for all measurements – they do not change as you change measurements. Settings like these are called “Meas Global” and are unaffected by Meas Preset. For example, the Center Freq setting is the same for all measurements - it does not change as you change measurements.

Key Path	Front-panel key
Initial S/W Revision	Prior to A.02.00
Help Map ID	3057

Auto Tune

Auto Tune is an immediate action key. When it is pressed, it causes the analyzer to change Center Frequency to the strongest signal in the tunable span of the analyzer, excluding the LO. It is designed to quickly get you to the most likely signal(s) of interest, with no signal analysis knowledge required. As such, there are no configurable parameters for this feature. There are only pre-selected values that work in most real world situations.

NOTE You may see a slight pause before the signal of interest is presented at midscreen.

Remote Command:	[:SENSe] :FREQuency:TUNE:IMMediate
Initial S/W Revision:	Prior to A.02.00
Key Path:	FREQ Channel
Help Map ID:	3058

Center Freq

Sets the frequency that corresponds to the horizontal center of the graticule (when frequency Scale Type is set to linear). While adjusting the Center Frequency the Span is held constant, which means that both Start Frequency and Stop Frequency will change.

Pressing Center Freq also sets the frequency entry mode to Center/Span. In Center/Span mode, the center frequency and span values are displayed below the graticule, and the default active function in the Frequency menu is **Center Freq**.

The center frequency setting is the same for all measurements within a mode, that is, it is Meas Global. Some modes are also able to share a Mode Global center frequency value. If this is the case, the Mode will have a **Global Settings** key in its **Mode Setup** menu.

The **Center Freq** function sets (and queries) the Center Frequency for the currently selected input. If your analyzer has multiple inputs, and you select another input, the Center Freq changes to the value for that input. SCPI commands are available to directly set the Center Freq for a specific input.

See “RF Center Freq” on page 1275

Common Measurement Functions 1

See [“I/Q Center Freq” on page 1276](#)

See [“Center Frequency Presets” on page 1275](#)

Key Path	FREQ Channel
Scope	Meas Global
Remote Command	[:SENSE] :FREQuency:CENTer <freq> [:SENSE] :FREQuency:CENTer?
Example	FREQ:CENT 50 MHz FREQ:CENT UP changes the center frequency to 150 MHz if you use FREQ:CENT:STEP 100 MHz to set the center frequency step size to 100 MHz FREQ:CENT?
Notes	This command sets either the RF or I/Q Center Frequency depending on the selected input. For RF input it is equivalent to FREQ:RF:CENT For I/Q input it is equivalent to FREQ:IQ:CENT Preset and Max values are dependant on Hardware Options (503, 507, 508, 513, 526)
Dependencies	The Center Frequency can be limited by Start or Stop Freq limits, if the Span is so large that Start or Stop hit their limit.
Couplings	When operating in “swept span”, any value of the Center Frequency or Span that is within the frequency range of the analyzer is allowed when the value is being set through the front panel numeric key pad or the SCPI command. The other parameter is forced to a different value if needed, to keep the Start and the Stop Frequencies within the analyzer’s frequency range
Preset	Depends on instrument maximum frequency, mode, measurement, and selected input.. See “Center Frequency Presets” on page 1275 , “RF Center Freq” on page 1275 , and “I/Q Center Freq” on page 1276 .
State Saved	Saved in instrument state
Min	Depends on instrument maximum frequency, mode, measurement, and selected input.. See “Center Frequency Presets” on page 1275 , “RF Center Freq” on page 1275 , and “I/Q Center Freq” on page 1276 .
Max	Depends on instrument maximum frequency, mode, measurement, and selected input.. See “Center Frequency Presets” on page 1275 , “RF Center Freq” on page 1275 , and “I/Q Center Freq” on page 1276 .
Default Unit	Hz

Status Bits/OPC Dependencies	non-overlapped
Initial S/W Revision	Prior to A.02.00
Help Map ID	3059

Center Frequency Presets

Model numbers E6607:

Freq Option	CF after Mode Preset	Stop Freq after Mode Preset	Max Freq (can't tune above)

The following table shows the Center Frequency Presets for various modes:

Mode	CF Preset for RF
BASIC	1 GHz
WIMAXOFDMA,	1 GHz
CDMA1XEV	1 GHz
LTE	1 GHz
LTETDD	1 GHz
WCDMA	1 GHz
CDMA2K	1 GHz
GSM	935.2 MHz
TDSCDMA	1 GHz
BTooth	1 GHz
ADEMOD	1 GHz

RF Center Freq

SCPI command for specifying the RF Center Frequency. This command will set the Center Frequency to be used when the RF input is selected, even if the RF input is not the input which is selected at the time the command is sent. Note that the **Center Freq** function in the **Frequency** menu on the front panel always applies to the currently selected input.

Scope	Meas Global
Remote Command	[:SENSe] :FREQuency:RF:CENTer <freq> [:SENSe] :FREQuency:RF:CENTer?
Example	FREQ:RF:CENT 30 MHz

Common Measurement Functions 1

Notes	This command is the same in all modes, but the parameter is Measurement Global. So the value is independent in each mode and common across all the measurements in the mode.
Dependencies	If the electronic/soft attenuator is enabled, any attempt to set Center Frequency such that the Stop Frequency would be >3.6 GHz fails and results in an advisory message. If the equivalent SCPI command is sent, this same message is generated as part of a “-221, Settings conflict” warning.
Preset	See table above
State Saved	Saved in instrument state.
Min	-79.999995 MHz
Max	See table above. Basically instrument maximum frequency – 10 Hz minimum span. If the knob or step keys are being used, depends on the value of the other three interdependent parameters
Initial S/W Revision	Prior to A.02.00
Modified at S/W Revision	A.03.00
Help Map ID	0

I/Q Center Freq

SCPI command for specifying the I/Q Center Frequency. This command will set the Center Frequency to be used when the I/Q input is selected, even if the I/Q input is not the input which is selected at the time the command is sent. Note that the **Center Freq** function in the **Frequency** menu on the front panel always applies to the currently selected input.

Scope	Meas Global
Remote Command	[:SENSe] :FREQuency:IQ:CENTer <freq> [:SENSe] :FREQuency:IQ:CENTer?
Example	FREQ:IQ:CENT: 30 MHz
Notes	This command is the same in all modes, but the parameter is Measurement Global. So the value is independent in each mode and common across all the measurements in the mode.
Preset	0 Hz
State Saved	Saved in instrument state.
Min	-40.049995 MHz
Max	40.049995 MHz
Initial S/W Revision	Prior to A.02.00
Help Map ID	0

Start Freq

Sets the frequency at the left side of the graticule. While adjusting the start frequency, the stop frequency is held constant, which means that both the center frequency and span will change.

Start Freq also sets the frequency entry mode to Start or Stop. In Start or Stop mode, the start frequency and stop frequency values are displayed below the graticule, and the default active function in the Frequency menu is **Start Freq**.

Key Path	FREQ Channel
Remote Command	[:SENSe] :FREQuency:STARt <freq> [:SENSe] :FREQuency:STARt?
Example	FREQ:STAR 200 MHz FREQ:STAR?
Notes	Max values depends on Hardware Options (503, 507, 508, 513, 526)
Dependencies	<p>By direct entry: You cannot set Start frequency > Stop frequency. You cannot set Start frequency = Stop frequency. You cannot select zero span by setting Start = Stop. You cannot set Start Frequency to a value that would create a span of less than 10 Hz. If you try to do any of these, Stop Frequency will change to maintain a minimum value of 10 Hz for the difference between Start and Stop.</p> <p>With the knob or step keys: Cannot increment Start Freq to a value greater than Stop Freq – 10 Hz. If already in zero span, cannot increment at all, and the first decrement will be forced to at least 10 Hz.</p> <p>The Start Frequency can be limited by Span limits, if the Stop Frequency is below its preset value.</p> <p>If the electronic/soft attenuator is enabled, any attempt to set the Start Frequency such that the Stop Frequency would be >3.6 GHz fails and results in an advisory message. If the equivalent SCPI command is sent, this same message is generated as part of a “-221, Settings conflict” warning.</p>
Couplings	See details under “Center Freq” on page 1273 for more information about span couplings.
Preset	Start Freq does not preset. On Mode Preset, Span & CF preset, and Start Freq is derived. On a Meas Preset only Span presets, CF does not, so Start Freq will vary depending on CF.
State Saved	Saved in instrument state
Min	–80 MHz If the knob or step keys are being used, depends on the value of the other three interdependent parameters
Max	Depends on the instrument maximum frequency – 10 Hz minimum span. If the knob or step keys are being used, it depends on the value of the other three interdependent parameters.

Common Measurement Functions 1

Default Unit	Hz
Status Bits/OPC dependencies	non-overlapped
Initial S/W Revision	Prior to A.02.00
Modified at S/W Revision	A.03.00
Help Map ID	3060

Stop Freq

Sets the frequency at the right side of the graticule. While adjusting the stop Frequency, the start frequency is held constant, which means that both the center frequency and span will change.

Stop Freq also sets the frequency entry mode to Start or Stop. In Start or Stop mode, the start frequency and stop frequency values are displayed below the graticule, and the default active function in the Frequency menu is **Start Freq**.

Key Path	FREQ Channel
Remote Command	[:SENSE] :FREQuency:STOP <freq> [:SENSE] :FREQuency:STOP?
Example	FREQ:STOP 220 MHz FREQ:STOP?
Notes	Preset and Max values are depending on Hardware Options (503, 507, 508, 513, 526)
Dependencies	<p>By direct entry: You cannot set the Stop frequency < Start frequency. You cannot set Start frequency = Stop frequency. You cannot select zero span by setting Start = Stop. You cannot set Stop Frequency to a value that would create a span of less than 10 Hz. If you try to do any of these, Start Frequency will change to maintain a minimum value of 10 Hz for the difference between Start and Stop.</p> <p>With the knob or step keys: Cannot decrement Stop Freq to a value less than Start Freq + 10 Hz. If already in zero span, cannot decrement at all, and the first increment will be forced to at least 10 Hz.</p> <p>The Stop Frequency can be limited by Span limits, if the Start Frequency is above its preset value.</p> <p>If the electronic/soft attenuator is enabled, any attempt to set the Stop Frequency >3.6 GHz fails and results in an advisory message. If the equivalent SCPI command is sent, this same message is generated as part of a “-221, Settings conflict” warning.</p>
Couplings	<p>See details under “Center Freq” on page 1273 for more information about span couplings.</p> <p>You cannot set Start frequency = Stop frequency. You cannot select zero span by setting Start = Stop. The instrument will alter the value of the last setting to maintain a minimum value of 10 Hz for the difference between Start and Stop.</p>

Preset	Stop Freq does not preset. On Mode Preset, Span & CF preset, and Stop Freq is derived. On a Meas Preset only Span presets, CF does not, so Stop Freq will vary depending on CF.
State Saved	Saved in instrument state
Min	-79.999999999 MHz If the knob or step keys are being used, depends on the value of the other three interdependent parameters
Max	Depends on instrument maximum frequency. If the knob or step keys are being used, depends on the value of the other three interdependent parameters.
Default Unit	Hz
Status Bits/OPC dependencies	non-overlapped
Initial S/W Revision	Prior to A.02.00
Modified at S/W Revision	A.03.00
Help Map ID	3061

CF Step

Changes the step size for the center frequency and start and stop frequency functions. Once a step size has been selected and the center frequency function is active, the step keys (and the UP|DOWN parameters for Center Frequency from remote commands) change the center frequency by the step-size value. The step size function is useful for finding harmonics and sidebands beyond the current frequency span of the analyzer.

Note that the start and stop frequencies also step by the CF Step value.

Key Path	FREQ Channel
Remote Command	[:SENSe] :FREQuency:CENTer:STEP[:INCRement] <freq> [:SENSe] :FREQuency:CENTer:STEP[:INCRement] ? [:SENSe] :FREQuency:CENTer:STEP:AUTO OFF ON 0 1 [:SENSe] :FREQuency:CENTer:STEP:AUTO?
Example	FREQ:CENT:STEP:AUTO ON FREQ:CENT:STEP 500 MHz FREQ:CENT UP increases the current center frequency value by 500 MHz FREQ:CENT:STEP? FREQ:CENT:STEP:AUTO?
Notes	Preset and Max values are dependant on Hardware Options (503, 508, 513, 526)

Common Measurement Functions 1

Dependencies	Span, RBW, Center frequency If the electronic/soft attenuator is enabled, any attempt to change the value of the center frequency >3.6 GHz by pressing the Up-arrow key, fails and results in an advisory message. If the equivalent SCPI command is sent, this same message is generated as part of a “-221, Settings conflict” warning.
Couplings	When auto-coupled in a non-zero span, the center frequency step size is set to 10% of the span. When auto-coupled in zero span, the center frequency step size is set to the equivalent -3 dB RBW value.
Preset	Auto ADEMOD: 1 MHz ON
State Saved	Saved in instrument state
Min	- (the maximum frequency of the instrument). (that is, 27 GHz max freq instrument has a CF step range of +/- 27 GHz)
Max	the maximum frequency of the instrument. (that is, 27 GHz max freq instrument has a CF step range of +/- 27 GHz)
Default Unit	Hz
Status Bits/OPC dependencies	non-overlapped
Initial S/W Revision	Prior to A.02.00
Modified at S/W Revision	A.03.00
Help Map ID	3062

Freq Offset

Enables you to set a frequency offset value to account for frequency conversions outside of the analyzer. This value is added to the display readout of the marker frequency, center frequency, start frequency, stop frequency, and all other absolute frequency settings in the analyzer including frequency count. When a frequency offset is entered, the value appears below the center of the graticule. To eliminate an offset, perform a Mode Preset or set the frequency offset to 0 Hz.

See “[More Information](#)” on page 1281.

Remote Command	[:SENSE] :FREQuency:OFFSet <freq> [:SENSE] :FREQuency:OFFSet?
Example	FREQ:OFFS 10 MHz
Default Unit	Hz
Initial S/W Revision	Prior to A.02.00
Key Path	FREQ Channel
Scope	Meas Global

Notes	Preset and Max values are depending on Hardware Options (503, 507, 508, 513, 526)
Dependencies	Frequency Offset is not available when the frequency scale is set to Log
Preset	See the table in See “Center Frequency Presets” on page 1275
State Saved	Saved in instrument state
Min	–500 GHz
Max	500 GHz
Status Bits/OPC dependencies	non-overlapped
Backwards Compatibility SCPI	DISPlay:WINDow[1]:TRACe:X[:SCALe]:OFFSet
Modified at S/W Revision	A.04.00
Help Map ID	3064

More Information

This command does not affect any bandwidths or the settings of relative frequency parameters such as delta markers or span. It does not affect the current hardware settings of the analyzer, but only the displayed frequency values. Entering an offset does not affect the trace position or display, just the value of the start and stop frequency and the values represented by the trace data. The frequency values of exported trace data, queried trace data, markers, trace data used in calculations such as N dB points, trace math, etc., are all affected by Freq Offset. Changing the offset, even on a trace that is not updating will immediately change all of the above, without taking new data.

NOTE If a trace is exported with a nonzero Freq Offset, the exported data will contain the trace data with the offset applied. Therefore, if that trace were to be imported back into the analyzer, you would want Freq Offset to be 0, or the offset would be applied again to data which is already offset. No such care need be taken when saving a State+Trace file because the data and state are saved together.

Input/Output

The Input/Output features are common across multiple Modes and Measurements. These common features are described in this section. See the Measurement description for information on features that are unique.

The Input/Output key accesses the softkeys that control the Input/Output parameters of the instrument. In general, these are functions associated with external connections to the test set, either to the inputs or the outputs. Since these connections tend to be fairly stable within a given setup, in general, the input/output settings do not change when you Preset the test set.

Other functions related to the input/output connections, but which tend to change on a measurement by measurement basis, can be found under the **Trigger** and **AMPTD Y Scale** keys. In addition, some of the digital I/O bus configurations can be found under the **System** key.

Common Measurement Functions 1

NOTE The functions in the Input/Output menu are "global" (common) to all Modes (applications). But individual Input/Output functions only appear in a Mode if they apply to that Mode. Functions that apply to a Mode but not to all measurements in the Mode may be grayed-out in some measurements.

[“Input/Output variables - Preset behavior” on page 1284](#)

The Input Port selection is the first menu under the **Input/Output** key:

Key Path:	Front-panel key
Remote Command:	[:SENSE] :FEED RF AIQ EMIXer [:SENSE] :FEED?
Example:	:FEED RF :FEED?
Couplings:	The [:SENSE]:FEED RF command turns the calibrator OFF
Preset:	This setting is unaffected by a Preset or power cycle. It survives a Mode Preset and mode changes. It is set to RF on a "Restore Input/Output Defaults" or "Restore System Defaults->All"
State Saved:	Saved in instrument state
Backwards Compatibility SCPI:	[:SENSE]:FEED AREFERENCE In the PSA the calibrator was one of the inputs and selected using the AREF parameter to the same :FEED command that switched the inputs. In the X-Series it is controlled in a separate menu and overrides the input selection. For code compatibility the [:SENSE]:FEED AREFERENCE command is provided, and is aliased to [SENSE]:FEED:AREF REF50, which causes the input to be switched to the 50 MHz calibrator. The [:SENSE]:FEED RF command switches the input back to the RF port and turns the calibrator OFF, thus providing full compatibility with the PSA calibrator function. Note that after sending this, the query [:SENSE]:FEED? will NOT return “AREF” but instead the currently selected input.
Backwards Compatibility SCPI:	[:SENSE]:FEED IQ IONLY QONLY [:SENSE]:FEED? The parameters IQ IONLY QONLY are supported for backwards compatibility with the E44406A. [:SENSE]:FEED IQ aliases to [:SENSE]:FEED:IQ:TYPE IQ [:SENSE]:FEED IONLY aliases to [:SENSE]:FEED:IQ:TYPE IONLY [:SENSE]:FEED QONLY aliases to [:SENSE]:FEED:IQ:TYPE QONLY The query [:SENSE]:FEED? will always returns AIQ whatever the type of legacy parameters IQ IONLY QONLY has been used.

<p>Backwards Compatibility Notes:</p>	<p>Most of the settings in the X-Series Input/Output system, including External Gain, Amplitude Corrections settings and data, etc., are shared by all modes and are not changed by a mode switch. Furthermore, most variables in the Input/Output system key are not affected by Mode Preset. Both of these behaviors represent a departure from legacy behavior.</p> <p>In the X-Series. Input/Output settings are reset by using the "Restore Input/Output Defaults" function. They can also be reset to their default values through the System->Restore System Defaults-> In/Out Config key or through the System ->Restore System Defaults -> All key (and corresponding SCPI).</p> <p>While this matches most use cases better, it does create some code compatibility issues. For example, Amplitude Corrections are no longer turned off by a Mode Preset, but instead by using the "Restore Input/Output Defaults" key/SCPI.</p> <p>Although Input/Output settings are not part of each Mode's State, they are saved in the Save State files, so that all of the instrument settings can be recalled with Recall State, as in legacy instruments.</p>
<p>Initial S/W Revision:</p>	<p>Prior to A.02.00</p>
<p>Help Map ID:</p>	<p>3065</p>

<p>Remote Command:</p>	<p>:INPut:MIXer EXTernal INTernal :INPut:MIXer?</p>
<p>Example:</p>	<p>INP:MIX INT INP:MIX?</p>
<p>Notes:</p>	<ol style="list-style-type: none"> 1. In legacy analyzers you choose between the Internal mixer or an External Mixer. In the X-Series, the External Mixer is one of the choices for the Input and hence is selected using the FEED command (:SENSe:FEED EXTMIxer). <p>For compatibility, the INPut:MIXer EXTernal INTernal legacy command is mapped as follows:</p> <ol style="list-style-type: none"> 1. When INPut:MIXer EXTernal is received, SENSe:FEED EMIXer is executed. 2. When INPut:MIXer INTernal is received, SENSe:FEED RF is executed. 3. When INPut:MIXer? is received, the response will be INT if any input other than the external mixer is selected and EXT if the external mixer is selected
<p>Preset:</p>	<p>INT</p>
<p>Backwards Compatibility Notes:</p>	<ol style="list-style-type: none"> 1. PSA supports the following SCPI Command : :INPut:MIXer:TYPE PRESelected UNPReselect :INPut:MIXer:TYPE? PXA does not support the :INPut:MIXer:TYPE command.

Common Measurement Functions 1

Initial S/W Revision:	A.08.01
Help Map ID:	0

Input/Output variables - Preset behavior

Virtually all the input/output settings are NOT a part of mode preset. They can be set to their default value by one of the three ways - by using the Restore Input/Output Defaults key on the first page of the input/output menu, by using the System->Restore System Defaults->Input/Output Settings or by using the System -> Restore System Defaults->All. Also, they survive a Preset and a Power cycle.

A very few of the Input/Output settings do respond to a Mode Preset; for example, if the Calibrator is on it turns off on a Preset, and if DC coupling is in effect it switches to AC on a Preset. These exceptions are made in the interest of reliability and usability, which overrides the need for absolute consistency.

Exceptions are noted in the SCPI table for the excepted functions.

RF Input

Selects the front-panel RF input port to be the test set signal input. If RF is already selected, pressing this key accesses the RF input setup functions.

Key Path:	Input/Output
Example:	[::SENSe]:FEED RF
Readback:	The RF input port, RF coupling, and current input impedance settings appear on this key as: "XX, YY, ZZ" where XX is RF, RF2, RFIO1, RFIO2, depending on what input is selected (only appears on test sets with multiple RF inputs) YY is AC or DC ZZ is 50 or 75
Initial S/W Revision:	Prior to A.02.00
Help Map ID:	3068

Input Z Correction

Sets the input impedance for unit conversions. This affects the results when the y-axis unit is voltage or current units (dBmV, dB μ V, dB μ A, V, A), but not when it is power units (dBm, W). The impedance you select is for computational purposes only, since the actual impedance is set by internal hardware to 50 ohms. Setting the computational input impedance to 75 ohms is useful when using a 75 ohm to 50 ohm adapter to measure a 75 ohm device on an test set with a 50 ohm input impedance.

There are a variety ways to make 50 to 75 ohm transitions, such as impedance transformers or minimum loss pads. The choice of the solution that is best for your measurement situation requires balancing the amount of loss that you can tolerate with the amount of measurement frequency range that you need. If you are using one of these pads/adaptors with the **Input Z Corr** function, you might also want to use the **Ext Gain** key. This function is used to set a correction value to compensate for the gain (loss) through

your pad. This correction factor is applied to the displayed measurement values.

Key Path:	Input/Output, RF Input
Remote Command:	[:SENSE] :CORRection:IMPedance [:INPut] [:MAGNitude] 50 75 [:SENSE] :CORRection:IMPedance [:INPut] [:MAGNitude] ?
Example:	CORR:IMP 75 sets the input impedance correction to 75 ohms. CORR:IMP?
Couplings:	When the main RF Input is selected, the Input Z Correction will automatically change to 50 ohms. You may then change it to whatever is desired.
Preset:	This is unaffected by a Preset but is set to 50 ohms on a "Restore Input/Output Defaults" or "Restore System Defaults->All" Some instruments/options may have 75 ohms available.
State Saved:	Saved in instrument state
Readback:	50 Ω or 75 Ω Current setting reads back to the RF key.
Initial S/W Revision:	Prior to A.02.00
Help Map ID:	3069

RF Input Port

Specifies the RF input port used. The RF Input Port key only appears on units with multiple inputs, and lets you switch between the two inputs.

Switching from the RF input port to one of the RFIO ports, on units which have them, changes the receiver performance of the instrument.

Key Path:	Input/Output, RF Input
Remote Command:	[:SENSE] :FEED:RF:PORT [:INPut] RFIN RFIN2 RFIO1 RFIO2 [:SENSE] :FEED:RF:PORT [:INPut] ?
Example:	:FEED:RF:PORT RFIN
Dependencies:	This key only appears in models that support multiple inputs. If the SCPI command is sent with unsupported parameters in any other model, an error is generated, -221.1900, "Settings conflict;option not installed" When any input is selected in a measurement that does not support it, the "No result; Meas invalid with this input" error condition occurs, and the measurement returns invalid data when queried.
Preset:	This is unaffected by Mode Preset but is set to RF on a "Restore Input/Output Defaults" or "Restore System Defaults -> All"
State Saved:	Saved in State

Common Measurement Functions 1

Readback:	The current RF Input Port selected is read back to this key
Backwards Compatibility SCPI:	INPut<1 2>:TYPE INPUT1 INPUT2 INPut<1 2>:TYPE? included for R&S ESU compatibility. In the MXE, the INPUT1 parameter is aliased to RFIN and the INPUT2 parameter is aliased to RFIN2
Initial S/W Revision:	A.05.01
Help Map ID:	29997

RF Input

Specifies using the main RF port for the current measurement

Key Path:	Input/Output, RF Input, RF Input Port
Example:	:FEED:RF:PORT RFIN
ReadBack:	RF Input
Initial S/W Revision:	A.05.01
Help Map ID:	29998

RFIO1

Specifies using the RFIO 1 port, if supported, for the current measurement

Key Path:	Input/Output, RF Input, RF Input Port
Example:	:FEED:RF:PORT RFIO1
Dependencies:	Only available in EXT. If Multiport Adapter is ON, Select RF Input to RFIO1, an error message is generated: “-221, Settings conflict; RFIO1 or RFIO2 Port unavailable when Multiport Adapter is ON”.
ReadBack:	RFIO 1
Initial S/W Revision:	A.05.01
Help Map ID:	29999

RFIO2

Specifies using the RFIO 2 port, if supported, for the current measurement

Key Path:	Input/Output, RF Input, RF Input Port
Example:	:FEED:RF:PORT RFIO2

Dependencies:	Only available in EXT. If Multiport Adapter is ON, Select RF Input to RFIO1, an error message is generated: “-221, Settings conflict; RFIO1 or RFIO2 Port unavailable when Multiport Adapter is ON”.
ReadBack:	RFIO 2
Initial S/W Revision:	A.05.01
Help Map ID:	30000

RF Calibrator

Lets you choose a calibrator signal to look at or turns the calibrator "off".

Key Path:	Input/Output
Remote Command:	[:SENSE] :FEED:AREFERENCE REF50 REF4800 OFF [:SENSE] :FEED:AREFERENCE?
Example:	FEED:AREF REF50 selects the 50 MHz amplitude reference as the signal input. FEED:AREF REF4800 selects the 4.8 GHz amplitude reference as the signal input FEED:AREF OFF turns the calibrator "off" (switches back to the selected input – RF or I/Q)
Dependencies:	Selecting an input (RF or I/Q) turns the Calibrator OFF. This is true whether the input is selected by the keys or with the [:SENSE]:FEED command. The 4.8 GHz internal reference is only available in some models and frequency range options. If the 4.8 GHz reference is not present, the 4.8 GHz softkey will be blanked, and if the REF4800 parameter is sent, the test set will generate an error.
Couplings:	When one of the calibrator signals is selected, the test set routes that signal (an internal amplitude reference) to the test set, and changes the main input selection to RF so the calibrator signal can be seen. When you turn the calibrator off it does not switch back to the previously selected input.
Preset:	OFF
State Saved:	Saved in instrument state
Readback:	Off, 50 MHz, 4.8 GHz
Initial S/W Revision:	Prior to A.02.00
Help Map ID:	3086

Remote Command:	:CALibration:SOURce:STATE OFF ON 0 1 :CALibration:SOURce:STATE?
------------------------	--

Common Measurement Functions 1

Notes:	For ESA backwards compatibility. In the ESA the calibrator was a separate output which you connected to the input and switched on with this command. In the X-Series, the ON parameter is aliased to the [SENSe]:FEED:AREF REF50 command and the OFF parameter is aliased to [SENSe]:FEED:AREF OFF. When CALibration:SOURce:STATe? is received, 1 will be returned if any of the references is selected and 0 if the Calibrator is "Off"
Preset:	OFF
Initial S/W Revision:	Prior to A.02.00
Help Map ID:	0

50 MHz

Selects the 50 MHz internal reference as the input signal.

Key Path:	Input/Output, RF Calibrator
Example:	:FEED:AREF REF50
Readback:	50 MHz
Initial S/W Revision:	Prior to A.02.00
Help Map ID:	3087

Off

Switches the input back to the selected input (RF or I/Q)

Key Path:	Input/Output, RF Calibrator
Example:	:FEED:AREF OFF
Readback:	Off
Initial S/W Revision:	Prior to A.02.00
Help Map ID:	3085

External Gain

Compensates for gain or loss in the measurement system outside the test set. The External Gain is subtracted from the amplitude readout (or the loss is added to the amplitude readout). So, the displayed signal level represents the signal level at the output of the device-under-test, which can be the input of an external device that provides gain or loss.

Entering an External Gain value does not affect the Reference Level, therefore the trace position on screen changes, as do all of values represented by the trace data. Thus, the values of exported trace data, queried trace data, marker amplitudes, trace data used in calculations such as N dB points, trace math, peak threshold, etc., are all affected by External Gain. Changing the External Gain, even on a trace which

is not updating, will immediately change all of the above, without new data needing to be taken.

NOTE Changing the External Gain causes the test set to immediately stop the current sweep and prepare to begin a new sweep. The data will not change until the trace data updates because the offset is applied to the data as it is taken. If a trace is exported with a nonzero External Gain, the exported data will contain the trace data with the offset applied.

Key Path:	Input/Output
Couplings:	The Ext Preamp, MS, and BS keys may be grayed out depending on which measurement is currently selected. If any of the grayed out keys are pressed, or the equivalent SCPI command is sent, an advisory message is generated.
Readback:	1-of-N selection [variable]
Initial S/W Revision:	Prior to A.02.00
Help Map ID:	3090

Ext Preamp

This function is similar to the reference level offset function. Both affect the displayed signal level. Ref Lvl Offset is a mathematical offset only, no test set configuration is affected. Ext Preamp gain is used when determining the auto-coupled value of the Attenuator. The External Gain value and the Maximum Mixer Level settings are both part of the automatic setting equation for the RF attenuation setting. (10 dB of Attenuation is added for every 10 dB of External Gain.)

Note that the Ref Lvl Offset and Maximum Mixer Level are described in the Amplitude section. They are reset by the instrument Preset. The External Preamp Gain is reset by the "Restore Input/Output Defaults" or "Restore System Defaults->All functions. . The External Gain is subtracted from the amplitude readout so that the displayed signal level represents the signal level at the output of the device-under-test, which is the input of the external device that is providing gain or loss.

Key Path:	Input/Output, External Gain
Remote Command:	[:SENSe] :CORRection:SA [:RF] :GAIN <rel_amp1 > [:SENSe] :CORRection:SA [:RF] :GAIN?
Example:	CORR:SA:GAIN 10 sets the Ext Gain value to 10 dB CORR:SA:GAIN -10 sets the Ext Gain value to -10 dB (that is, an attenuation of 10 dB)
Notes:	Does not auto return.
Dependencies:	The reference level limits are determined in part by the External Gain/Atten, Max Mixer Level, and RF Atten. This key is grayed out in Modes that do not support External Gain

Common Measurement Functions 1

Preset:	This is unaffected by Preset but is set to 0 dB on a "Restore Input/Output Defaults" or "Restore System Defaults->All"
State Saved:	Saved in instrument state
Min:	-120 dB
Max:	120 dB
Readback:	Preamp Gain, <Ext Gain value> dB
Backwards Compatibility SCPI:	[[:SENSE]:CORRection:OFFSet[:MAGNitude] The legacy "Ext Preamp Gain" key is now called "Ext Gain" and the sub-menu has choices of Ext Preamp MS BTS for backwards compatibility.
Initial S/W Revision:	Prior to A.02.00
Help Map ID:	3091

MS

Sets an external gain/attenuation value for MS (Mobile Station) tests.

Key Path:	Input/Output, External Gain
Remote Command:	[[:SENSE]:CORRection:MS[:RF]:GAIN <rel_amp1> [:SENSE]:CORRection:MS[:RF]:GAIN?
Example:	CORR:MS:GAIN 10 sets the Ext Gain value to 10 dB CORR:MS:GAIN -10 sets the Ext Gain value to -10 dB (that is, a loss of 10 dB.)
Notes:	Does not auto return.
Dependencies:	The reference level limits are determined in part by the External Gain, Max Mixer Level, RF Atten This key is grayed out in modes that do not support MS.
Preset:	This is unaffected by a Preset but is set to 0 dB on a "Restore Input/Output Defaults" or "Restore System Defaults->All"
State Saved:	Saved in instrument state.
Min:	-100 dB
Max:	100 dB
Readback:	MS, <Ext Gain value> dB
Initial S/W Revision:	Prior to A.02.00
Help Map ID:	3092

Remote Command:	[:SENSE] :CORRection:MS [:RF] :LOSS <rel_ampl> [:SENSE] :CORRection:MS [:RF] :LOSS?
Example:	CORR:MS:LOSS 10 sets the Ext Gain value to –10 dB, and subsequently querying :LOSS will give 10 dB CORR:MS:LOSS –10 sets the Ext Gain value to 10 dB, and subsequently querying :LOSS will give –10 dB
Notes:	A positive value of <rel_ampl> in the above command means a loss and a negative value indicates a gain. Anytime :LOSS is set it sets :GAIN to the negative value of the parameter sent. Anytime :LOSS is queried it gives the negative of :GAIN
Preset:	This is unaffected by a Preset but is set to 0 dB on a "Restore Input/Output Defaults" or "Restore System Defaults->All"
Min:	100 dB
Max:	–100 dB
Initial S/W Revision:	Prior to A.02.00
Help Map ID:	0

BTS

Sets an external attenuation value for BTS (Base Transceiver Station) tests.

Key Path:	Input/Output, External Gain
Remote Command:	[:SENSE] :CORRection:BTS [:RF] :GAIN <rel_ampl> [:SENSE] :CORRection:BTS [:RF] :GAIN?
Example:	CORR:BTS:GAIN 10 sets the Ext Gain value to 10 dB CORR:BTS:GAIN –10 sets the Ext Gain value to –10 dB (that is, a loss of 10 dB.)
Notes:	Does not auto return.
Dependencies:	The reference level limits are determined in part by the External Gain, Max Mixer Level, RF Atten This key is grayed out in modes that do not support BTS.
Preset:	This is unaffected by a Preset but is set to 0 dB on a "Restore Input/Output Defaults" or "Restore System Defaults->All"
State Saved:	Saved in instrument state.
Min:	–100 dB
Max:	100 dB

Common Measurement Functions 1

Readback:	BTS, <Ext Gain value> dB
Initial S/W Revision:	Prior to A.02.00
Help Map ID:	3093

Remote Command:	<code>[:SENSe] :CORRection:BTS [:RF] :LOSS <rel_ampl></code> <code>[:SENSe] :CORRection:BTS [:RF] :LOSS?</code>
Example:	<code>CORR:BTS:LOSS 10</code> sets the Ext Gain value to -10 dB, and subsequently querying <code>:LOSS</code> will give 10 dB <code>CORR:BTS:LOSS -10</code> sets the Ext Gain value to 10 dB, and subsequently querying <code>:LOSS</code> will give -10 dB
Notes:	A positive value of <rel_ampl> in the above command means a loss and a negative value indicates a gain. Anytime <code>:LOSS</code> is set it sets <code>:GAIN</code> to the negative value of the parameter sent. Anytime <code>:LOSS</code> is queried it gives the negative of <code>:GAIN</code>
Preset:	This is unaffected by a Preset but is set to 0 dB on a "Restore Input/Output Defaults" or "Restore System Defaults->All"
Min:	100 dB
Max:	-100 dB
Initial S/W Revision:	Prior to A.02.00
Help Map ID:	0

Restore Input/Output Defaults

This selection causes the group of settings and data associated with the **Input/Output** key to be a reset to their default values. In addition, when a Source is installed, licensed and selected, Restore Input/Output defaults will initiate a Source Preset.

This level of Restore System Defaults does not affect any other system settings or mode settings and does not cause a mode switch. All the features described in this section are reset using this key, including Input Corrections and Data (described in the Corrections section).

Key Path:	Input/Output
Example:	<code>:SYST:DEF INP</code> presets all the Input/Output variables to their factory default values.
Notes:	Refer to the Utility Functions for information about Restore System Defaults and the complete description of the <code>:SYSTem:DEfault INPut:</code> command.
Initial S/W Revision:	Prior to A.02.00
Help Map ID:	3094

Data Source

Gives you the choice of either using a hardware input signal as the input or raw data stored in a data storage buffer from an earlier acquisition. You can also share raw data across certain measurements that support this feature. The measurements must be capable of storing raw data. There are three choices under this menu. You can select "Inputs" which is the same as selecting one of the inputs from the input port, for example RF, AREF, I/Q, or IFALign. Selecting "Capture Buffer" allows you to use data that has been stored earlier in the same measurement or from a previous measurement using the "Current Meas -> Capture Buffer" feature. Selecting "Recorded Data" allows you to playback long data capture records stored in the record buffer.

Key Path:	Input/Output
Remote Command:	[:SENSe] :FEED:DATA INPut STORed [:SENSe] :FEED:DATA?
Example:	FEED:DATA STOR FEED:DATA?
Notes:	INPut = Inputs STORed = Capture Buffer
Dependencies:	Not all inputs are available in all modes. Unavailable keys are grayed out.
Preset:	This is unaffected by Preset but is set to INPut on a "Restore Input/Output Defaults" or "Restore System Defaults->All"
State Saved:	Saved in instrument state
Readback:	Variable
Backwards Compatibility SCPI:	[:SENSe]:FEED:SOURce INPut STORed [:SENSe]:FEED:SOURce?
Initial S/W Revision:	Prior to A.02.00
Help Map ID:	3095

Inputs

Sets the measurement to use the input selections (RF, AREF, I/Q)

Key Path:	Input/Output, Data Source
Example:	FEED:DATA INP causes the measurement to look at the input selection
Notes:	Does not auto return.
Readback:	Inputs
Initial S/W Revision:	Prior to A.02.00

Common Measurement Functions 1

Help Map ID:	3096
--------------	------

Capture Buffer

Some WCDMA and demod measurements support this feature. This allows sharing of the raw data across certain measurements. If you want to make another measurement on the same signal, you would store that raw data using the "Current Meas -> Capture Buffer" key. Then the data is available for the next measurement to use. You must have raw data stored in the instrument memory before the Capture Buffer choice is available for use.

Key Path:	Input/Output, Data Source
Example:	FEED:DATA STOR causes stored measurement data to be used with a different measurement that supports this.
Notes:	Does not auto return. This key is grayed out when you switch to a measurement that does not support this feature.
Dependencies:	If you switch to a measurement that does not support this feature, then the instrument switches to use "Inputs" and grays out this key. If the grayed out key is pressed, it generates a message.
Readback:	Stored Data
Initial S/W Revision:	Prior to A.02.00
Help Map ID:	3097

Current Meas -> Capture Buffer

Pressing this key stores the raw data of one measurement in the internal memory of the instrument where it can then be used by a different measurement by pressing "Stored Data". When raw data is stored, then the data source selection switch automatically changes to "Stored Data". Stored raw data cannot be directly accessed by a user. There is no save/recall function to save the raw data in an external media. However if you want to get the stored raw data, you must first perform a measurement using the stored raw data. Now you can access the used raw data, which is the same as stored raw data, using the FETCh or READ commands.

Key Path:	Input/Output, Data Source
Remote Command:	[:SENSE] : FEED : DATA : STORE
Example:	FEED:DATA:STOR stores recorded data
Notes:	This is command only, there is no query
Backwards Compatibility SCPI:	[:SENSE] : FEED : SOURce : STORE
Initial S/W Revision:	Prior to A.02.00
Help Map ID:	3099

Corrections

This key accesses the Amplitude Corrections menu.

Amplitude Corrections arrays can be entered, sent over SCPI, or loaded from a file. They allow you to correct the response of the test set for various use cases. The X-series supports four separate Corrections arrays, each of which can contain up to 2000 points. They can be turned on and off individually and any or all can be on at the same time.

Trace data is in absolute units and corrections data is in relative units, but we want to be able to display trace data at the same time as corrections data. Therefore we establish a reference line to be used while building or editing a Corrections table. The reference line is halfway up the display and represents 0 dB of correction. It is labeled "0 dB CORREC". It is drawn in blue.

Corrections data is always in dB. Whatever dB value appears in the correction table represents the correction to be applied to that trace at that frequency. So if a table entry shows 30 dB that means we ADD 30 dB to each trace to correct it before displaying it.

In zero span, where the frequency is always the center frequency of the test set, we apply the (interpolated) correction for the center frequency to all points in the trace. In the event where there are two correction amplitudes at the center frequency, we apply the first one in the table.

Note that the corrections are applied as the data is taken; therefore, a trace in **View** (Update Off) will not be affected by changes made to the corrections table after the trace is put in **View**.

Instruments that have multiple Input/Output RF ports can have different corrections applied to the different ports. There are 4 sets of corrections that can be applied to the RF ports; ports cannot share the same set of corrections but a single port can have multiple corrections applied to it. The correction data is applied to incoming signals as well as transmitted signals and is in the form of a list of spot frequencies and amplitude correction levels.

Key Path:	Input/Output, Corrections
Mode:	SEQAN, TDSCDMA
Dependencies:	<p>This key will only appear if you have the proper option installed in your instrument.</p> <p>Amplitude correction may not be available in all modes; if a mode does not support amplitude correction, the Corrections key should be blanked while in that mode. If an application supports corrections but the current measurement does not, then the key should be grayed out in that measurement.</p> <p>This menu selection does not have any effect when Input/Output, RF Output & Test Set Config, Multiport Adapter, Multiport Adapter is set to the On state and Input/Output, RF Output & Test Set Config, RF Output is RF Output.</p>
Preset:	Corrections arrays are reset (deleted) by Restore Input/Output Defaults. They survive shutdown and restarting of the test set application, which means they will survive a power cycle.
Initial S/W Revision:	A.02.00
Help Map ID:	3101

Correction On/Off

Turning the Selected Correction on allows the values in it to be applied to the data. This also automatically turns on "Apply Corrections" (sets it to ON), otherwise the correction would not take

Common Measurement Functions 1

effect.

A new sweep is initiated if an amplitude correction is switched on or off. Note that changing, sending or loading corrections data does NOT directly initiate a sweep, however in general these operations will turn corrections on, which DOES initiate a sweep.

Key Path:	Input/Output, Corrections
Remote Command:	[:SENSe] :CORRection:CSET [1] 2 3 4 5 6 [:STATe] ON OFF 1 0 [:SENSe] :CORRection:CSET [1] 2 3 4 5 6 [:STATe] ?
Example:	SENS:CORR:CSET1 ON
Dependencies:	Turning this on automatically turns on "Apply Corrections" Only the first correction array (Correction 1) supports antenna units. When this array is turned on, and it contains an Antenna Unit other than "None", the Y Axis Unit of the test set is forced to that Antenna Unit. All other Y Axis Unit choices are grayed out. Note that this means that a correction file with an Antenna Unit can only be loaded into the Corrections 1 register. Consequently only for Correction 1 does the dropdown in the Recall dialog include .ant, and if an attempt is made to load a correction file into any other Correction register which DOES contain an antenna unit, a Mass Storage error is generated. This command will generate an "Option not available" error unless you have the proper option installed in your instrument.
Preset:	Not affected by a Preset. Set to OFF by Restore Input/Output Defaults
State Saved:	Saved in instrument state.
Backwards Compatibility Notes:	Unlike legacy analyzers, Preset does not turn Corrections off (Restore Input/Output Defaults does).
Initial S/W Revision:	A.02.00
Help Map ID:	3104

Properties

Accesses a menu that lets you set the properties of the selected correction.

Key Path:	Input/Output, Corrections
Initial S/W Revision:	A.02.00
Help Map ID:	3105

Select Correction

Specifies the selected correction. The term "selected correction" is used throughout this document to specify which

correction will be affected by the functions.

Key Path:	Input/Output, Corrections, Properties
Notes:	The selected correction is remembered even when not in the correction menu.
Preset:	Set to Correction 1 by Restore Input/Output Defaults.
Readback:	Correction 1 Correction 2 Correction 3 Correction 4 Correction 5 Correction 6
Initial S/W Revision:	A.02.00
Help Map ID:	Use 3557

Frequency Interpolation

This setting controls how the correction values per-bucket are calculated. We interpolate between frequencies in either the logarithmic or linear scale.

This setting is handled and stored individually per correction set.

See [“Interpolation” on page 1297](#)

Key Path:	Input/Output, Corrections, Properties
Remote Command:	[:SENSe] :CORRection:CSET [1] 2 3 4 5 6 :X:SPACing LINear LOGarithmic [:SENSe] :CORRection:CSET [1] 2 3 4 5 6 :X:SPACing?
Example:	CORR:CSET:X:SPAC LIN
Preset:	Unaffected by a Preset. Set to Linear by Restore Input/Output Defaults.
State Saved:	Saved in instrument state.
Initial S/W Revision:	A.02.00
Help Map ID:	3108

Interpolation

For each bucket processed by the application, all of the correction factors at the frequency of interest (center frequency of each bucket) are summed and added to the amplitude. All trace operations and post processing treat this post-summation value as the true signal to use.

To effect this correction, the goal, for any particular start and stop frequency, is to build a correction trace, whose number of points matches the current Sweep Points setting of the instrument, which will be used to apply corrections on a bucket by bucket basis to the data traces.

For amplitudes that lie between two user specified frequency points, we interpolate to determine the amplitude value. You may select either linear or logarithmic interpolation between the frequencies.

If we interpolate on a log scale, we assume that the line between the two points is a straight line on the log scale. For example, let’s say the two points are (2,4) and (20,1). A straight line between them on a log scale looks like:

Common Measurement Functions 1

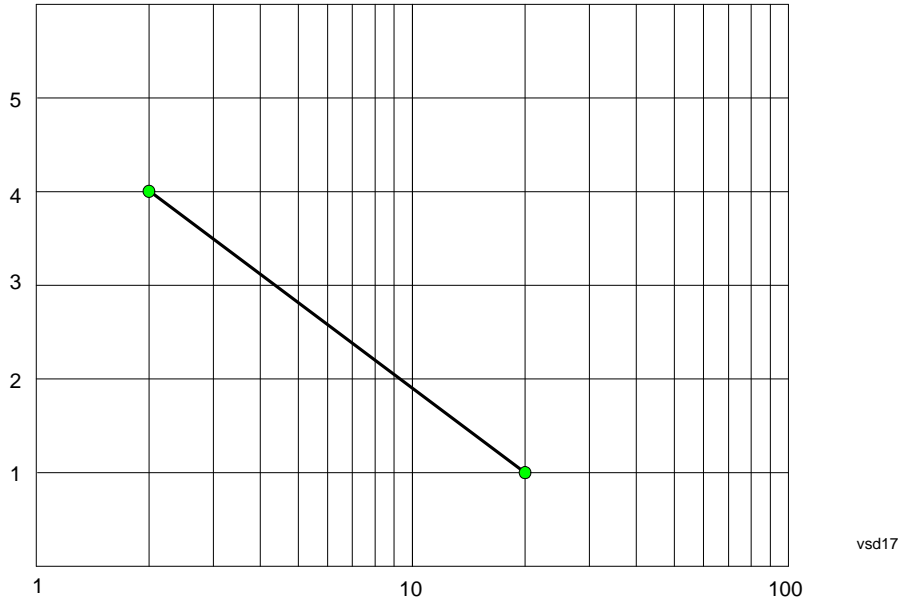

On a linear scale (like that of the test set), this translates to:

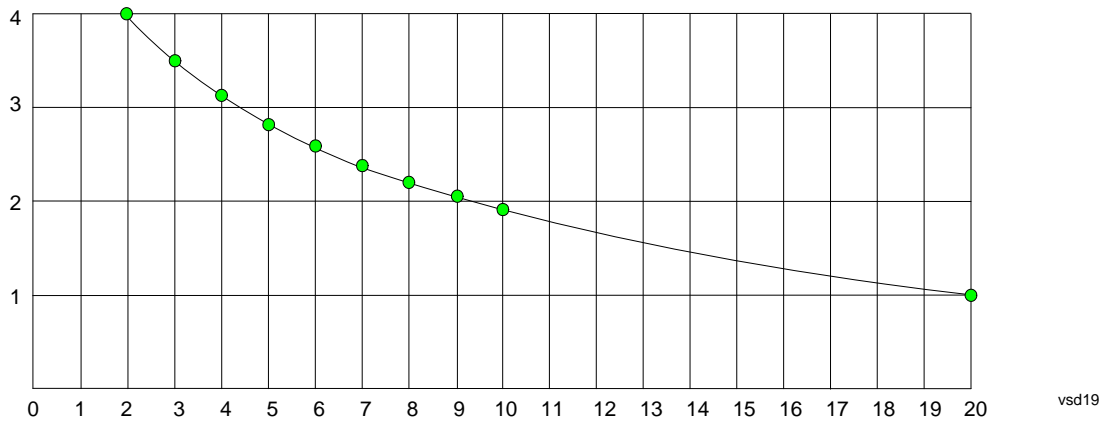

If we interpolate on a linear scale, we assume that the two points are connected by a straight line on the linear scale, as below:

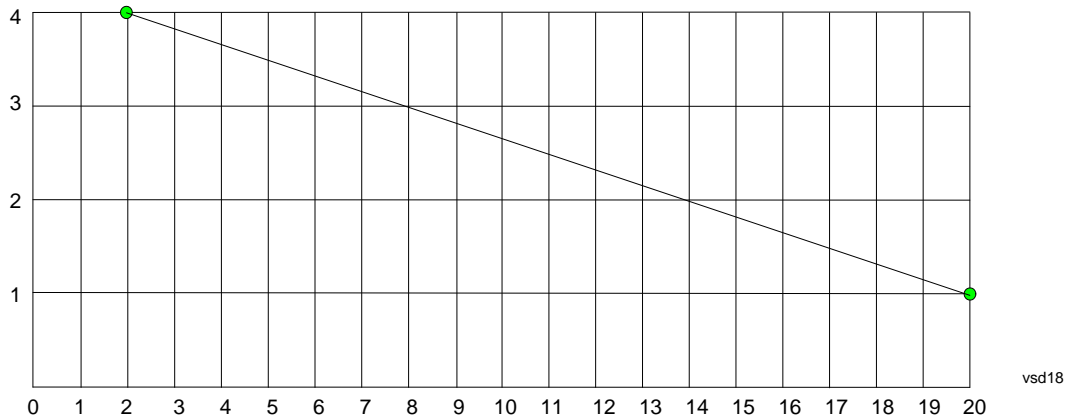

The correction to be used for each bucket is taken from the interpolated correction curve at the center of the bucket.

Description

Sets an ASCII description field which will be stored in an exported file. Can be displayed in the active function area by selecting as the active function, if desired to be in a screen dump.

Key Path:	Input/Output, Corrections, Properties
Remote Command:	[:SENSE] :CORRection:CSET [1] 2 3 4 5 6 :DESCription "text" [:SENSe] :CORRection:CSET [1] 2 3 4 5 6 :DESCription?
Example:	:CORR:CSET1:DESC "11941A Antenna correction"
Notes:	45 chars max; may not fit on display if max chars used
Preset:	Unaffected by a Preset. Set to empty by Restore Input/Output Defaults
State Saved:	Saved in instrument state.
Initial S/W Revision:	A.02.00
Help Map ID:	3106

Comment

Sets an ASCII comment field which will be stored in an exported file. Can be displayed in the active function area by selecting as the active function, if desired to be in a screen dump.

Key Path:	Input/Output, Corrections, Properties
Remote Command:	[:SENSE] :CORRection:CSET [1] 2 3 4 5 6 :COMMeNt "text " [:SENSe] :CORRection:CSET [1] 2 3 4 5 6 :COMMeNt?
Example:	:CORR:CSET1:COMM "this is a comment"
Notes:	60 chars max; may not fit on display if max chars used
Preset:	Unaffected by Preset. Set to empty by Restore Input/Output Defaults
State Saved:	Saved in instrument state
Initial S/W Revision:	A.02.00
Help Map ID:	3107

RF Port

This menu and all of its submenus are only available in the EXT.

Maps one of the sets of corrections to one of the IO ports.

Key Path:	Input/Output, Corrections, Properties
Mode:	SEQAN

Common Measurement Functions 1

Remote Command:	[:SENSe] :CORRection:CSET [1] 2 3 4 5 6 :RF:PORT RFIN RFIO1 RFIO2 RFOut [:SENSe] :CORRection:CSET [1] 2 3 4 5 6 :RF:PORT?
Example:	:CORR:CSET:RF:PORT RFIN
Remote Command Notes:	
Dependencies:	Only available in EXT
Couplings:	
Preset:	Unaffected by Preset. Set to RF by Restore Input/Output Defaults
State Saved:	Saved in State
Initial S/W Revision:	A.05.01
Help Map ID:	30001

RF Input

The port that the current corrections will be applied to.

Key Path:	Input/Output, Corrections, Properties, RF Port
Example:	:CORR:CSET:RF:PORT RFIN
Dependencies:	Only available in EXT
ReadBack:	RF IN
Initial S/W Revision:	A.05.01
Help Map ID:	30002

RFOut

The port that the current corrections will be applied to.

Key Path:	Input/Output, Corrections, Properties, RF Port
Example:	:CORR:CSET:RF:PORT RFO
Dependencies:	Only available in EXT
ReadBack:	RFOut
Initial S/W Revision:	A.05.01
Help Map ID:	30003

RFIO1

The port that the current corrections will be applied to. Pressing this key again allows the user access to the menu for specifying which internal device the corrections for RFIO 1 will be applied to.

Key Path:	Input/Output, Corrections, Properties, RF Port
-----------	---

Remote Command:	[:SENSE] :CORRection:CSET [1 2 3 4 5 6 :RF:PORT:RFIO1 SOURce ANALyzer BOTH [:SENSE] :CORRection:CSET [1 2 3 4 5 6 :RF:PORT:RFIO1?
Example:	:CORR:CSET:RF:PORT:RFIO1 BOTH
Preset:	Both
State Saved:	Saved in State
Help Map ID:	30004

Correct Source

Sets the corrections for the RFIO1 port to be applied to the source.

Key Path:	Input/Output, Corrections, Properties, RF Port
Example:	:CORR:CSET:RF:PORT:RFIO1 SOUR
Readback:	"Correct Source"
Help Map ID:	30005

Correct Analyzer

Sets the corrections for the RFIO1 port to be applied to the test set.

Key Path:	Input/Output, Corrections, Properties, RF Port
Example:	:CORR:CSET:RF:PORT:RFIO1 ANAL
Readback:	"Correct Analyzer"
Help Map ID:	30006

Correct Source and Analyzer

Sets the corrections for the RFIO1 port to be applied to both the source and the test set.

Key Path:	Input/Output, Corrections, Properties, RF Port
Example:	:CORR:CSET:RF:PORT:RFIO1 BOTH
Readback:	"Correct Source and Analyzer"
Help Map ID:	30007

RFIO2

The port that the current corrections will be applied to. Pressing this key again allows the user access to the menu for specifying which internal device the corrections for RFIO 2 will be applied to.

Key Path:	Input/Output, Corrections, Properties, RF Port
-----------	---

Common Measurement Functions 1

Remote Command:	[:SENSe] :CORRection:CSET [1] 2 3 4 5 6 :RF:PORT:RFIO2 SOURce ANALyzer BOTH [:SENSe] :CORRection:CSET [1] 2 3 4 5 6 :RF:PORT:RFIO2?
Example:	:CORR:CSET:RF:PORT:RFIO2 BOTH
Preset:	Both
State Saved:	Saved in State
Help Map ID:	30008

Correct Source

Sets the corrections for the RFIO2 port to be applied to the source.

Key Path:	Input/Output, Corrections, Properties, RF Port
Example:	:CORR:CSET:RF:PORT:RFIO2 SOUR
Readback:	"Correct Source"
Help Map ID:	30009

Correct Analyzer

Sets the corrections for the RFIO2 port to be applied to the test set.

Key Path:	Input/Output, Corrections, Properties, RF Port
Example:	:CORR:CSET:RF:PORT:RFIO2 ANAL
Readback:	"Correct Analyzer"
Help Map ID:	30010

Correct Source and Analyzer

Sets the corrections for the RFIO2 port to be applied to both the source and the test set.

Key Path:	Input/Output, Corrections, Properties, RF Port
Example:	:CORR:CSET:RF:PORT:RFIO2 BOTH
Readback:	"Correct Source and Analyzer"
Help Map ID:	30011

Edit

Invokes the integrated editing facility for this correction set.

When entering the menu, the editor window turns on, the selected correction is turned **On**, **Apply Corrections** is set to **On**, the amplitude scale is set to **Log**, and the Amplitude Correction ("Ampcor")

trace is displayed. The actual, interpolated correction trace is shown in green for the selected correction. Note that since the actual interpolated correction is shown, the correction trace may have some curvature to it. This trace represents only the correction currently being edited, rather than the total, accumulated amplitude correction for all amplitude corrections which are currently on, although the total, accumulated correction for all corrections which are turned on is still applied to the data traces.

Because corrections data is always in dB, but the Y-axis of the test set is in absolute units, it is necessary to establish a reference line for display of the Corrections data. The reference line is halfway up the display and represents 0 dB of correction. It is labeled “0 dB CORREC”. It is drawn in blue.

Corrections data is always in dB. Whatever dB value appears in the correction table represents the correction to be applied to that trace at that frequency. So if a table entry shows 30 dB that means we ADD 30 dB to each trace to correct it before displaying it. By definition all points are connected. If a gap is desired for corrections data, enter 0 dB.

Note that a well-designed Corrections array should start at 0 dB and end at 0 dB. This is because whatever the high end point is will be extended to the top frequency of the instrument, and whatever the low end point is will be extended down to 0 Hz. So for a Corrections array to have no effect outside its range, you should start and end the array at 0 dB.

NOTE The table editor will only operate properly if the test set is sweeping, because its updates are tied to the sweep system. Thus, you should not try to use the editor in single sweep, and it will be sluggish during compute-intensive operations like narrow-span FFT sweeps.

When exiting the edit menu (by using the **Return** key or by pressing an instrument front-panel key), the editor window turns off and the Ampcor trace is no longer displayed; however, **Apply Corrections** remains **On**, any correction that was on while in the editor remains on, and the amplitude scale returns to its previous setting.

Corrections arrays are not affected by a Preset, because they are in the Input/Output system. They also survive shutdown and restarting of the test set application, which means they will survive a power cycle.

Key Path:	Input/Output, Corrections
Initial S/W Revision:	A.02.00
Help Map ID:	29983

Navigate

Lets you move through the table to edit the desired point.

Key Path:	Input/Output, Corrections, Edit
Notes:	There is no value readback on the key
Min:	1
Max:	2000
Initial S/W Revision:	A.02.00

Common Measurement Functions 1

Help Map ID:	3545
--------------	------

Frequency

Lets you edit the frequency of the current row.

Key Path:	Input/Output, Corrections, Edit
Notes:	There is no value readback on the key.
Min:	0
Max:	1 THz
Initial S/W Revision:	A.02.00
Help Map ID:	3572

Amplitude

Lets you edit the Amplitude of the current row.

Key Path:	Input/Output, Corrections, Edit
Notes:	There is no value readback on the key.
Min:	-1000 dB
Max:	1000 dB
Initial S/W Revision:	A.02.00
Help Map ID:	3574

Insert Point Below

Inserts a point below the current point. The new point is a copy of the current point and becomes the current point. The new point is not yet entered into the underlying table, and the data in the row is displayed in light gray.

Key Path:	Input/Output, Corrections, Edit
Initial S/W Revision:	A.02.00
Help Map ID:	3576

Delete Point

Deletes the currently-selected point, whether or not that point is being edited, and selects the Navigate functionality. The point following the currently-selected point (or the point preceding if there is none) will be selected.

Key Path:	Input/Output, Corrections, Edit
Initial S/W Revision:	A.02.00
Help Map ID:	3581

Delete Correction

Deletes the correction values for this set. When this key is pressed a prompt is placed on the screen that says “Please press Enter or OK key to delete correction. Press ESC or Cancel to close this dialog.” The deletion is only performed if you press OK or Enter.

Key Path:	Input/Output, Corrections
Remote Command:	[:SENSe] :CORRection:CSET [1] 2 3 4 5 6 :DELete
Example:	CORR:CSET:DEL CORR:CSET1:DEL CORR:CSET4:DEL
Notes:	Pressing this key when no corrections are present is accepted without error.
Initial S/W Revision:	A.02.00
Help Map ID:	3115

Apply Corrections

Applies amplitude corrections which are marked as ON to the measured data. If this is set to OFF, then no amplitude correction sets will be used, regardless of their individual on/off settings. If set to ON, the corrections that are marked as ON (see “[Correction On/Off](#)” on page 1295) are used.

Key Path:	Input/Output, Corrections
Remote Command:	[:SENSe] :CORRection:CSET:ALL [:STATe] ON OFF 1 0 [:SENSe] :CORRection:CSET:ALL [:STATe] ?
Example:	SENS:CORR:CSET:ALL OFF This command makes sure that no amplitude corrections are applied, regardless of their individual on/off settings.
Preset:	Not affected by Preset. Set to OFF by Restore Input/Output Defaults
State Saved:	Saved in instrument state.
Initial S/W Revision:	A.02.00
Help Map ID:	3102

Delete All Corrections

Erases all correction values for all 4 Amplitude Correction sets.

When this key is pressed a prompt is placed on the screen that says “Please press Enter or OK key to delete all corrections. Press ESC or Cancel to close this dialog.” The deletion is only performed if you press OK or Enter.

Key Path:	Input/Output, Corrections
Remote Command:	[:SENSe] :CORRection:CSET:ALL:DELete

Common Measurement Functions 1

Example:	CORR:CSET:ALL:DEL
Initial S/W Revision:	A.02.00
Help Map ID:	3119

Remote Correction Data Set Commands

Set (Replace) Data (Remote Command Only)

The command takes an ASCII series of alternating frequency and amplitude points, each value separated by commas.

The values sent in the command will totally replace all existing correction points in the specified set.

An Ampcor array can contain 2000 points maximum.

Remote Command:	<code>[[:SENSE]:CORREction:CSET[1] 2 3 4 5 6:DATA <freq>, <ampl>, . . .</code> <code>[[:SENSE]:CORREction:CSET[1] 2 3 4 5 6:DATA?</code>
Example:	CORR:CSET1:DATA 10000000,-1.0,20000000,1.0 This defines two correction points at (10 MHz, -1.0 dB) and (20 MHz, 1.0 dB) for correction set 1.
Preset:	Empty after Restore Input/Output Defaults. Survives a shutdown or restart of test set application (including a power cycle).
State Saved:	Saved in instrument state.
Min:	Freq: 0 Hz Amptd: -1000 dBm
Max:	Freq: 1 THz Amptd: +1000 dBm
Initial S/W Revision:	A.02.00
Help Map ID:	0

Merge Correction Data (Remote Command Only)

The command takes an ASCII series of alternating frequency and amplitude points, each value separated by commas. The difference between this command and Set Data is that this merges new correction points into an existing set.

Any new point with the same frequency as an existing correction point will replace the existing point's amplitude with that of the new point.

An Ampcor array can contain 2000 total points, maximum.

Remote Command:	<code>[[:SENSE]:CORREction:CSET[1] 2 3 4 5 6:DATA:MERGE <freq>, <ampl>, ...</code>
------------------------	--

Example:	CORR:CSET1:DATA:MERGE 15000000,-5.0,25000000,5.0 This adds two correction points at (15 MHz, -5.0 dB) and (25 MHz, 5.0 dB) to whatever values already exist in correction set 1.
Preset:	Empty after Restore Input/Output Defaults. Survives shutdown/restart of test set application (including power cycle)
Min:	Freq: 0 Hz Amptd: -1000 dBm
Max:	Freq: 1 THz Amptd: +1000 dBm
Initial S/W Revision:	A.02.00
Help Map ID:	0

Freq Ref In

Specifies the frequency reference as being the internal reference, external reference or sensing the presence of an external reference.

When the frequency reference is set to internal, the internal 10 MHz reference is used even if an external reference is connected.

When the frequency reference is set to external, the instrument will use the external reference. However, if there is no external signal present, or it is not within the proper amplitude range, a condition error message is generated. When the external signal becomes valid, the error is cleared.

If Sense is selected, the instrument checks whether a signal is present at the external reference connector and will automatically switch to the external reference when a signal is detected. When no signal is present, it automatically switches to the internal reference. No message is generated as the reference switches between external and internal. The monitoring of the external reference occurs approximately on 1 millisecond intervals, and never occurs in the middle of a measurement acquisition, only at the end of the measurement (end of the request).

If for any reason the instrument's frequency reference is not able to obtain lock, Status bit 2 in the Questionable Frequency register will be true and a condition error message is generated. When lock is regained, Status bit 2 in the Questionable Frequency register will be cleared and the condition error will be cleared.

If an external frequency reference is being used, you must enter the frequency of the external reference if it is not exactly 10 MHz. The External Ref Freq key is provided for this purpose.

Key Path:	Input/Output
Remote Command:	[:SENSe] :ROSCillator :SOURce :TYPE INTernal EXTernal SENSe [:SENSe] :ROSCillator :SOURce :TYPE?
Preset:	This is unaffected by a Preset but is set to SENSe on a "Restore Input/Output Defaults" or "Restore System Defaults->All".

Common Measurement Functions 1

State Saved:	Saved in instrument state.
Status Bits/OPC dependencies:	STATus:QUESTIONable:FREQuency bit 2 set if unlocked.
Backwards Compatibility Notes:	1. Freq Ref In was not saved in state in the legacy instruments. It is a part of state in the X-Series.
Initial S/W Revision:	Prior to A.02.00
Help Map ID:	3124

Remote Command:	[:SENSE] :ROSCillator:SOURce?
Notes:	<p>The query [SENSE]:ROSCillator:SOURce? returns the current switch setting. This means:</p> <ol style="list-style-type: none"> 1. If it was set to SENSE but there is no external reference so the instrument is actually using the internal reference, then this query returns INTERNAL and not SENSE. 2. If it was set to SENSE and there is an external reference present, the query returns EXTERNAL and not SENSE. 3. If it was set to EXTERNAL, then the query returns "EXTERNAL" 4. If it was set to INTERNAL, then the query returns "INTERNAL"
Preset:	SENSE
Backwards Compatibility Notes:	<p>The query [:SENSE] :ROSCillator:SOURce? was a query-only command in ESA which always returned whichever reference the instrument was using. The instrument automatically switched to the ext ref if it was present.</p> <p>In PSA (which had no sensing) the command [:SENSE] :ROSCillator:SOURce set the reference (INT or EXT), so again its query returned the actual routing.</p> <p>Thus the query form of this command is 100% backwards compatible with both instruments.</p>
Initial S/W Revision:	Prior to A.02.00
Help Map ID:	0

Remote Command:	[:SENSE] :ROSCillator:SOURce INTernal EXTernal
Notes:	For PSA compatibility the command form is provided and is directly mapped to [:SENSE] :ROSCillator:SOURce:TYPE
Initial S/W Revision:	Prior to A.02.00
Help Map ID:	0

Sense

The external reference is used if a valid signal is sensed at the Ext Ref input. Otherwise the internal

reference is used.

Key Path:	Input/Output, Freq Ref In
Example:	:ROSC:SOUR:TYPE SENS
Readback:	Sense
Initial S/W Revision:	Prior to A.02.00
Help Map ID:	3127

Internal

The internal reference is used.

Key Path:	Input/Output, Freq Ref In
Example:	:ROSC:SOUR:TYPE INT
Readback:	Internal
Initial S/W Revision:	Prior to A.02.00
Help Map ID:	3128

External

The external reference is used.

Key Path:	Input/Output, Freq Ref In
Example:	:ROSC:SOUR:TYPE EXT
Readback:	External
Initial S/W Revision:	Prior to A.02.00
Help Map ID:	3129

Ext Ref Freq

This key tells the test set the frequency of the external reference. When the external reference is in use (either because the reference has been switched to External or because the Reference has been switched to Sense and there is a valid external reference present) this information is used by the test set to determine the internal settings needed to lock to that particular external reference signal.

For the instrument to stay locked, the value entered must be within 5 ppm of the actual external reference frequency. So it is important to get it close, or you risk an unlock condition.

Note that this value only affects the instrument's ability to lock. It does not affect any calculations or measurement results. See "Freq Offset" in the Frequency section for information on how to offset frequency values.

Key Path:	Input/Output, Freq Ref In
-----------	----------------------------------

Common Measurement Functions 1

Remote Command:	[:SENSe] :ROSCillator :EXTernal :FREQuency <freq> [:SENSe] :ROSCillator :EXTernal :FREQuency?
Example:	ROSC:EXT:FREQ 20 MHz sets the external reference frequency to 20 MHz, but does not select the external reference. ROSC:SOUR:TYPE EXT selects the external reference.
Notes:	Still available with Internal selected, to allow setup for when External is in use.
Preset:	This is unaffected by a Preset but is set to 10 MHz on a "Restore Input/Output Defaults" or "Restore System Defaults->All"
Min:	CXA: 10 MHz EXA: 10 MHz or 13 MHz, depending on whether N9010A-R13 is licensed MXA: 1 MHz PXA: 1 MHz 1 MHz
Max:	CXA: 10 MHz EXA: 10 MHz MXA: 50 MHz PXA: 50 MHz 50 MHz
Default Unit:	Hz
Initial S/W Revision:	Prior to A.02.00
Help Map ID:	3130

RF Output & Test Set Config

This menu and all of its submenus are only available in the EXT (E6607A/B/C).

Access the menu to select the front-panel RF output port to be the test set signal output. If RF is already selected, pressing this key accesses the RF output setup functions.

EXT (E6607A/B)

The RF Output & Test Set Config key allows you to set the RF Output Port and multipoint adapter unit which is connected to the EXT by USB for download of calibration data and additional control.

EXT (E6607C)

The RF Output & Test Set Config key allows you to set the RF Output Port and MPA settings.

Key Path:	Input/Output
Dependencies:	Only available in EXT

Preset:	All settings under this key are returned to their default state when Restore Input/Output Defaults is pressed.
State Saved:	Saved in State
Initial S/W Revision:	A.10.00
Help Map ID:	30017

RF Output

Specifies the RF Output Port used.

Switching from the RF Output port to one of the RFIO ports changes the transmitter performance of the instrument.

Key Path:	Input/Output, RF Output & Test Set Config
Remote Command:	[:SENSe] :FEED:RF:PORT:OUTPut RFOut RFIO1 RFIO2 [:SENSe] :FEED:RF:PORT:OUTPut ?
Example:	:FEED:RF:PORT:OUTP RFIO1
Dependencies:	Only available in EXT
Preset:	This is unaffected by Mode Preset but is set to RFOut on a "Restore Input/Output Defaults" or "Restore System Defaults -> All"
State Saved:	Saved in State
Readback Text:	The current RF Output Port selected is read back to this key
Initial S/W Revision:	A.05.01
Help Map ID:	30013

RF Out

The RF port that will be used for the current output

Key Path:	Input/Output, RF Output & Test Set Config, RF Output
Example:	:FEED:RF:PORT:OUTP RFO
Dependencies:	Only available in EXT
ReadBack:	RF Output
Initial S/W Revision:	A.05.01
Help Map ID:	30014

RFIO1

The RF port that will be used for the current output

Key Path:	Input/Output, RF Output & Test Set Config, RF Output
-----------	---

Common Measurement Functions 1

Example:	:FEED:RF:PORT:OUTP RFIO1
Dependencies:	Only available in EXT.
ReadBack:	RFIO1
Initial S/W Revision:	A.05.01
Help Map ID:	30015

RFIO2

The RF port that will be used for the current output

Key Path:	Input/Output, RF Output & Test Set Config, RF Output
Example:	:FEED:RF:PORT:OUTP RFIO2
Dependencies:	Only available in EXT.
ReadBack:	RFIO2
Initial S/W Revision:	A.05.01
Help Map ID:	30016

Multiport Adapter

The Multiport Adapter key allows you to set the multiport adapter unit which is connected to the EXT by USB for download of calibration data and additional control.

Multiport Adapter is only available in the EXT (E6607A/B/C), and is blanked for other models.

EXT (E6607A/B)

The Multiport Adapter key will not be displayed if the multiport adapter unit is not connected to the EXT by USB.

EXT (E6607C)

The MPA is integrated into the instrument; therefore, the Multiport Adapter key is always displayed.

See [“More Information” on page 1313](#)

Key Path:	Input/Output, RF Output & Test Set Config
Dependencies:	Multiport adapter is only available for EXT (E6607A/B) model, and is blanked for other models. Multiport adapter unit is connected to EXT by USB for download of calibration data and additional control.
Preset:	All settings under this key are returned to their default state when Restore Input/Output Defaults is pressed.

State Saved:	All settings under this key, are remembered when you unplugged the multiport adapter unit USB connection, so that when multiport adapter unit USB is connected again, all the multiport adapter functions will retain their previous settings, with the exception of Multiport Adapter which is set to OFF.
Initial S/W Revision:	A.10.00
Help Map ID:	0

More Information

Multiport adapter in the EXT (E6607A/B) supports the Agilent E6617A, which provides a USB connection for download of calibration data and additional control.

The connection diagram for Agilent E6617A switch unit is:

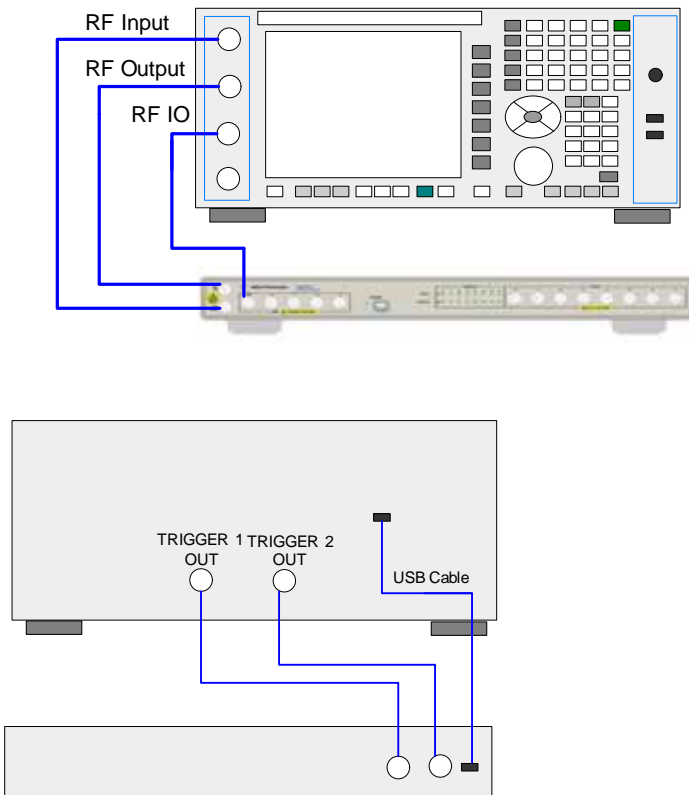

Multiport Adapter On/Off

Turning the Multiport Adapter On means that the multiport adapter unit is connected and it will be used for the measurements or source.

Turning the Multiport Adapter Off means that the multiport adapter unit will not be used for the analyzer or source.

Key Path:	Input/Output, RF Output & Test Set Config, Multiport Adapter
Remote Command:	[:SENSE] :MPADapter [:STATe] ON OFF 1 0 [:SENSE] :MPADapter [:STATe] ?

Common Measurement Functions 1

Example:	:MPAD ON
Dependencies:	Only when the multiport adapter unit is connected to the EXT by USB, it is appeared. Otherwise, it will not be displayed and set to OFF. If the current RF Input port is not RF Input, turn Multiport Adapter to On , an error message is generated: “-221, Settings conflict; RFIO1 or RFIO2 Port unavailable when Multiport Adapter is ON”.
Preset:	This is unaffected by Mode Preset but is set to OFF on a "Restore Input/Output Defaults" or "Restore System Defaults -> All"
Initial S/W Revision:	A.10.00
Help Map ID:	0

Input Port

Specifies the multiport adapter unit input port used.

Key Path:	Input/Output, RF Output & Test Set Config, Multiport Adapter
Remote Command:	[:SENSE] :MPADapter:PORT:INPut OFF RFIO0 RFIO1 RFIO2 RFIO3 RFIO4 RFIO5 RFIO6 RFIO7 [:SENSe] :MPADapter:PORT:INPut?
Example:	:MPAD:PORT:INP RFIO1
Dependencies:	This menu selection does not have any effect unless Input/Output, More, RF Output & Test Set Config, Multiport Adapter is set to the On state.
Preset:	This is unaffected by Mode Preset but is set to RFIO0 on a "Restore Input/Output Defaults" or "Restore System Defaults -> All"
State Saved:	Saved in State
Readback Text:	The current Multiport Adapter Input Port selected is read back to this key
Backwards Compatibility SCPI Notes:	The commands above are included for ESU compatibility
Initial S/W Revision:	A.10.00
Help Map ID:	0

OFF

Specifies using the multiport adapter input port OFF.

Key Path:	Input/Output, RF Output & Test Set Config, Multiport Adapter, Input Port
Example:	[:SENSE] :MPADapter:PORT:INPut OFF
ReadBack:	OFF
Initial S/W Revision:	A.10.00
Help Map ID:	0

RFIO0

Specifies using the multiport adapter input port RFIO 0.

Key Path:	Input/Output, RF Output & Test Set Config, Multiport Adapter, Input Port
Example:	[:SENSe] :MPADapter:PORT:INPut RFIO0
ReadBack:	RFIO 0
Initial S/W Revision:	A.10.00
Help Map ID:	0

RFIO1

Specifies using the multiport adapter input port RFIO 1.

Key Path:	Input/Output, RF Output & Test Set Config, Multiport Adapter, Input Port
Example:	[:SENSe]:MPADapter:PORT:INPut RFIO1
ReadBack:	RFIO 1
Initial S/W Revision:	A.10.00
Help Map ID:	0

RFIO2

Specifies using the multiport adapter Input port RFIO 2.

Key Path:	Input/Output, RF Output & Test Set Config, Multiport Adapter, Input Port
Example:	[:SENSe]:MPADapter:PORT:INPut RFIO2
ReadBack:	RFIO 2
Initial S/W Revision:	A.10.00
Help Map ID:	0

RFIO3

Specifies using the multiport adapter input port RFIO 3.

Key Path:	Input/Output, RF Output & Test Set Config, Multiport Adapter, Input Port
Example:	[:SENSe]:MPADapter:PORT:INPut RFIO3
ReadBack:	RFIO 3
Initial S/W Revision:	A.10.00
Help Map ID:	0

Common Measurement Functions 1

RFIO4

Specifies using the multiport adapter input port RFIO 4.

Key Path:	Input/Output, RF Output & Test Set Config, Multiport Adapter, Input Port
Example:	[::SENSe]:MPADapter:PORT:INPut RFIO4
ReadBack:	RFIO 4
Initial S/W Revision:	A.10.00
Help Map ID:	0

RFIO5

Specifies using the multiport adapter input port RFIO 5.

Key Path:	Input/Output, RF Output & Test Set Config, Multiport Adapter, Input Port, Page 2
Example:	[::SENSe]:MPADapter:PORT:INPut RFIO5
ReadBack:	RFIO 5
Initial S/W Revision:	A.10.00
Help Map ID:	0

RFIO6

Specifies using the multiport adapter input port RFIO 6.

Key Path:	Input/Output, RF Output & Test Set Config, Multiport Adapter, Input Port, Page 2
Example:	[::SENSe]:MPADapter:PORT:INPut RFIO6
ReadBack:	RFIO 6
Initial S/W Revision:	A.10.00
Help Map ID:	0

RFIO7

Specifies using the multiport adapter input port RFIO 7.

Key Path:	Input/Output, RF Output & Test Set Config, Multiport Adapter, Input Port, Page 2
Example:	[::SENSe]:MPADapter:PORT:INPut RFIO7
ReadBack:	RFIO 7
Initial S/W Revision:	A.10.00
Help Map ID:	0

Output Port

Specifies the multiport adapter unit output ports used. The Output Port key lets you set eight outputs ON/OFF. See the table below for bitmapping.

Multiport Adapter Output Port	Bit
RFIO0	0
RFIO1	1
RFIO2	2
RFIO3	3
RFIO4	4
RFIO5	5
RFIO6	6
RFIO7	7

Key Path:	Input/Output, RF Output & Test Set Config, Multiport Adapter
Remote Command:	[:SENSE] :MPADapter:PORT:OUTPut:BITMap <integer> [:SENSE] :MPADapter:PORT:OUTPut:BITMap?
Example:	:MPAD:PORT:OUTPut:BITMap 1
Notes:	Each bit is associated with a multiport adapter output port; as shown in the bitmap table above. The value of a bit is '0' if the corresponding multiport adapter output port is not selected, and '1' if it is. (For example, to select multiport adapter RFIO7 output port , set Bit 7 to '1'.) The field requires a decimal entry. For example, if multiport adapter selects the RFIO 7 output port and RFIO 0 output port, the Bit Mask for this combination is 10000001, and the value of this parameter is the decimal number '129'.
Dependencies:	This menu selection does not have any effect unless Input/Output, RF Output & Test Set Config, Multiport Adapter, Multiport Adapter is set to the On state and Input/Output, RF Output & Test Set Config, RF Output is RF Output port. When Input/Output, RF Output & Test Set Config, Multiport Adapter, Multiport Adapter is set to the On state and Input/Output, RF Output & Test Set Config, RF Output is set to RFIO1 or RFIO2 port, the Multiport Adapter GPS Output Port will be used.
Preset:	This is unaffected by Mode Preset but is set to "1" on a "Restore Input/Output Defaults" or "Restore System Defaults -> All"
State Saved:	Saved in State
Backwards Compatibility SCPI Notes:	The commands above are included for ESU compatibility
Initial S/W Revision:	A.10.00

Common Measurement Functions 1

Help Map ID:	0
--------------	---

RFIO0

Turn on or off the multiport adapter RFIO0 output port.

Key Path:	Input/Output, RF Output & Test Set Config, Multiport Adapter, Output Port
Preset:	Not affected by a Preset. Set to ON pressing System > Restore Defaults > Input/Output Settings or System > Restore Defaults > All.
State Saved:	Saved in instrument state.
Initial S/W Revision:	A.10.0
Help Map ID:	0

RFIO1

Turn on or off the multiport adapter RFIO1 output port.

Key Path:	Input/Output, RF Output & Test Set Config, Multiport Adapter, Output Port
Preset:	Not affected by a Preset. Set to OFF by pressing System > Restore Defaults > Input/Output Settings or System > Restore Defaults > All.
State Saved:	Saved in instrument state.
Initial S/W Revision:	A.10.0
Help Map ID:	0

RFIO2

Turn on or off the multiport adapter RFIO2 output port.

Key Path:	Input/Output, RF Output & Test Set Config, Multiport Adapter, Output Port
Preset:	Not affected by a Preset. Set to OFF by pressing System > Restore Defaults > Input/Output Settings or System > Restore Defaults > All.
State Saved:	Saved in instrument state.
Initial S/W Revision:	A.10.0
Help Map ID:	0

RFIO3

Turn on or off the multiport adapter RFIO3 output port.

Key Path:	Input/Output, RF Output & Test Set Config, Multiport Adapter, Output Port
Preset:	Not affected by a Preset. Set to OFF by pressing System > Restore Defaults > Input/Output Settings or System > Restore Defaults > All.
State Saved:	Saved in instrument state.

Initial S/W Revision:	A.10.0
Help Map ID:	0

RFIO4

Turn on or off the multiport adapter RFIO4 output port.

Key Path:	Input/Output, RF Output & Test Set Config, Multiport Adapter, Output Port
Preset:	Not affected by a Preset. Set to OFF by pressing System > Restore Defaults > Input/Output Settings or System > Restore Defaults > All.
State Saved:	Saved in instrument state.
Initial S/W Revision:	A.10.0
Help Map ID:	0

RFIO5

Turn on or off the multiport adapter RFIO5 output port.

Key Path:	Input/Output, RF Output & Test Set Config, Multiport Adapter, Output Port
Preset:	Not affected by a Preset. Set to OFF by pressing System > Restore Defaults > Input/Output Settings or System > Restore Defaults > All.
State Saved:	Saved in instrument state.
Initial S/W Revision:	A.10.0
Help Map ID:	0

RFIO6

Turn on or off the multiport adapter RFIO6 output port.

Key Path:	Input/Output, RF Output & Test Set Config, Multiport Adapter, Output Port, Page 2
Preset:	Not affected by a Preset. Set to OFF by pressing System > Restore Defaults > Input/Output Settings or System > Restore Defaults > All.
State Saved:	Saved in instrument state.
Initial S/W Revision:	A.10.0
Help Map ID:	0

RFIO7

Turn on or off the multiport adapter RFIO7 output port.

Key Path:	Input/Output, RF Output & Test Set Config, Multiport Adapter, Output Port, Page 2
-----------	--

Common Measurement Functions 1

Preset:	Not affected by a Preset. Set to OFF by pressing System > Restore Defaults > Input/Output Settings or System > Restore Defaults > All.
State Saved:	Saved in instrument state.
Initial S/W Revision:	A.10.0
Help Map ID:	0

Preamp On/Off

Turn on or off the preamplifier of the multiport adapter input path. It will provide one fix gain for the multiport adapter input path.

Key Path:	Input/Output, RF Output & Test Set Config, Multiport Adapter
Remote Command:	[:SENSe] :MPADapter :GAIN [:STATe] ON OFF 1 0 [:SENSe] :MPADapter :GAIN [:STATe] ?
Example:	:MPAD:GAIN ON
Dependencies:	This menu selection does not have any effect unless Input/Output, More, RF Output & Test Set Config, Multiport Adapter, Multiport Adapter is set to the On state.
Preset:	This is unaffected by Mode Preset but is set to OFF on a "Restore Input/Output Defaults" or "Restore System Defaults -> All"
State Saved:	Saved in instrument state.
Initial S/W Revision:	A.10.0
Help Map ID:	0

Amplitude Corrections

Corrections

Multiport Adapter Amplitude Corrections arrays can be entered by the user, sent over SCPI, or loaded from a file. The Multiport Adapter correction supports 16 separate Corrections arrays, each of which can contain up to 2000 points. They can be turned on and off individually and any or all can be on at the same time. Multiport Adapter has multiple Input/Output RF ports can have different corrections applied to the different ports. The correction data is applied to incoming signals as well as transmitted signals and is in the form of a list of spot frequencies and amplitude correction levels.

See section ["Amplitude Corrections"](#) on page 1320 for more information on Corrections.

Key Path:	Input/Output, RF Output & Test Set Config, Multiport Adapter
Mode:	Sequence Analyzer, I/Q Analyzer

Dependencies:	This key will only appear if you have the proper option installed in your instrument. Multiport Adapter Amplitude correction may not be available in all modes; if a mode does not support amplitude correction, the Correction On/Off and Apply Corrections On/Off keys should be grayed and un-accessible. This menu selection does not have any effect unless Input/Output, More, RF Output & Test Set Config, Multiport Adapter, Multiport Adapter is set to the On state.
Preset:	Multiport Adapter Corrections arrays are reset (deleted) by Restore Input/Output Defaults. They survive shutdown and restarting of the analyzer application, which means they will survive a power cycle.
Initial S/W Revision:	A.10.00
Help Map ID:	0

Select Correction

Specifies the selected correction. The term "selected correction" is used throughout this document to specify which correction will be affected by the functions.

Key Path:	Input/Output, RF Output & Test Set Config, Multiport adapter, Corrections
Mode:	Sequence Analyzer, I/Q Analyzer
Notes:	The selected correction is remembered even when not in the correction menu
Dependencies:	This menu selection does not have any effect unless Input/Output, More, RF Output & Test Set Config, Multiport Adapter, Multiport Adapter is set to the On state.
Preset:	Set to Correction 1 by Restore Input/Output Defaults
Readback:	Correction 1 Correction 2 Correction 3 Correction 4 Correction 5 Correction 6 Correction 7 Correction 9 Correction 9 Correction 10 Correction 11 Correction 12
Initial S/W Revision:	A.10.00
Help Map ID:	0

Correction On/Off

Turning the Selected Correction on allows the values in it to be applied to the data. This also automatically turns on "Apply Corrections" (sets it to ON), otherwise the correction would not take effect.

A new sweep is initiated if an amplitude correction is switched on or off. Note that changing, sending or loading corrections data does NOT directly initiate a sweep, however in general these operations will turn corrections on, which DOES initiate a sweep.

Key Path:	Input/Output, RF Output & Test Set Config, Multiport Adapter, Corrections
-----------	--

Common Measurement Functions 1

Remote Command:	[:SENSe]:MPADapter:CORRection:CSET[1] 2 3 4 5 6 7 8 9 10 11 12 13 14 15 16[:STATe] ON OFF 1 0 [:SENSe]:MPADapter:CORRection:CSET[1] 2 3 4 5 6 7 8 9 10 11 12 13 14 15 16[:STATe]?
Example:	SENS:MPAD:CORR:CSET ON
Dependencies:	<p>This menu selection does not have any effect unless Input/Output, More, RF Output & Test Set Config, Multiport Adapter, Multiport Adapter is set to the On state. This menu selection is hidden if the currently active measurement or mode does not support amplitude correction.</p> <p>Turning this on automatically turns on "Apply Corrections"</p> <p>Only the first correction array (Correction 1) supports antenna units. When this array is turned on, and it contains an Antenna Unit other than "None", the Y Axis Unit of the analyzer is forced to that Antenna Unit. All other Y Axis Unit choices are grayed out.</p> <p>Note that this means that a correction file with an Antenna Unit can only be loaded into the Corrections 1 register. Consequently only for Correction 1 does the dropdown in the Recall dialog include.ant, and if an attempt is made to load a correction file into any other Correction register which DOES contain an antenna unit, a Mass Storage error is generated.</p> <p>This command will generate an "Option not available" error unless you have the proper option installed in your instrument.</p>
Preset:	Not affected by a Preset. Set to OFF by Restore Input/Output Defaults
State Saved:	Saved in instrument state.
Initial S/W Revision:	A.10.00
Help Map ID:	0

Properties

Accesses a menu that lets you set the properties of the selected correction.

Key Path:	Input/Output, RF Output & Test Set Config, Multiport Adapter, Corrections
Dependencies:	This menu selection does not have any effect unless Input/Output, RF Output & Test Set Config, Multiport Adapter, Multiport Adapter is set to the On state. This menu selection is hidden if the currently active measurement or mode does not support amplitude correction.
Initial S/W Revision:	A.10.00
Help Map ID:	0

Select Correction

Specifies the selected correction. The term "selected correction" is used throughout this document to specify which

correction will be affected by the functions.

Key Path:	Input/Output, RF Output & Test Set Config, Multiport Adapter, Corrections, Properties
Notes:	The selected correction is remembered even when not in the correction menu
Dependencies:	This menu selection does not have any effect unless Input/Output, RF Output & Test Set Config, Multiport Adapter, Multiport Adapter is set to the On state
Preset:	Set to Correction 1 by Restore Input/Output Defaults.
Readback:	Correction 1 Correction 2 Correction 3 Correction 4 Correction 5 Correction 6 Correction 7 Correction 9 Correction 9 Correction 10 Correction 11 Correction 12 Correction 13 Correction 14 Correction 15 Correction 16
Initial S/W Revision:	A.10.00
Help Map ID:	0

Antenna Unit

For devices (like antennae) which make measurements of field strength or flux density, the correction array should contain within its values the appropriate conversion factors such that, when the data on the analyzer is presented in dBμV, the display is calibrated in the appropriate units. The "Antenna Unit" used for the conversion is contained within the corrections array database. It may be specified by the user or loaded in from an external file or SCPI.

When an array with an Antenna Unit other than "None" is turned on, the Y Axis Unit of the analyzer is forced to that unit. When this array is turned on, and it contains an Antenna Unit other than "None", the Y Axis Unit of the analyzer is forced to that Antenna Unit., and all other Y Axis Unit choices are grayed out.

Antenna Unit does not appear in all Modes that support Corrections. Only the modes listed in the Mode row of the table below support Antenna Units.

Key Path:	Input/Output, RF Output & Test Set Config, Multiport Adapter, Corrections, Properties
Mode:	SA
Remote Command:	[:SENSE] :MPADapter:CORRection:CSET [1] 2 3 4 5 6 7 8 9 10 11 12 13 14 15 16 :ANTenna [:UNIT] GAUSs PTESla UVM UAM NOConversion [:SENSE] :MPADapter:CORRection:CSET [1] 2 3 4 5 6 7 8 9 10 11 12 13 14 15 16 :ANTenna [:UNIT] ?
Example:	:MPAD:CORR:CSET:ANT GAUS
Dependencies:	Only the first correction array (Correction 1) supports antenna units. Note that this means that a correction file with an Antenna Unit can only be loaded into the Corrections 1 register. Consequently only for Correction 1 does the dropdown in the Recall dialog include.ant, and if an attempt is made to load a correction file into any other Correction register which DOES contain an antenna unit, a Mass Storage error is generated. Forceful message -250.3004
Preset:	Unaffected by Preset. Set to NOC by Restore Input/Output Defaults

Common Measurement Functions 1

State Saved:	Saved in State
Initial S/W Revision:	A.10.00
Help Map ID:	0

dB μ V/m

Sets the antenna unit to dB μ V/m. If this correction is turned on, and Apply Corrections is on, the Y Axis Unit will then be forced to dB μ V/m and all other Y Axis Unit selections will be grayed out.

Key Path:	Input/Output, RF Output & Test Set Config, Multiport Adapter, Corrections, Properties, Antenna Unit
Example:	:MPAD:CORR:CSET2:ANT UVM
Readback:	"dB μ V/m"
Initial S/W Revision:	A.10.00
Help Map ID:	0

dB μ A/m

Sets the antenna unit to dB μ A/m. If this correction is turned on, and Apply Corrections is on, the Y Axis Unit will then be forced to dB μ A/m and all other Y Axis Unit selections will be grayed out.

Key Path:	Input/Output, RF Output & Test Set Config, Multiport Adapter, Corrections, Properties, Antenna Unit
Example:	:MPAD:CORR:CSET2:ANT UVA
Readback:	" dB μ A/m"
Initial S/W Revision:	A.10.00
Help Map ID:	0

dBpT

Sets the antenna unit to dBpT. If this correction is turned on, and Apply Corrections is on, the Y Axis Unit will then be forced to dBpT and all other Y Axis Unit selections will be grayed out.

Key Path:	Input/Output, RF Output & Test Set Config, Multiport Adapter, Corrections, Properties, Antenna Unit
Example:	:MPAD:CORR:CSET3:ANT PTES
Readback:	"dBpT"
Initial S/W Revision:	A.10.00
Help Map ID:	0

dBG

Sets the antenna unit to dBG. If this correction is turned on, and Apply Corrections is on, the Y Axis Unit will then

be forced to dBG and all other Y Axis Unit selections will be grayed out.

Key Path:	Input/Output, RF Output & Test Set Config, Multiport Adapter, Corrections, Properties, Antenna Unit
Example:	:MPAD:CORR:CSET:ANT GAUS
Readback:	" dBG"
Initial S/W Revision:	A.10.00
Help Map ID:	0

None

Selects no antenna unit for this Correction set. Thus no Y Axis unit will be forced.

Key Path:	Input/Output, RF Output & Test Set Config, Multiport Adapter, Corrections, Properties, Antenna Unit
Example:	:MPAD:CORR:CSET4:ANT NOC
Readback:	"None"
Initial S/W Revision:	A.10.00
Help Map ID:	0

Frequency Interpolation

This setting controls how the correction values per-bucket are calculated. We interpolate between frequencies in either the logarithmic or linear scale.

This setting is handled and stored individually per correction set.

See [“Interpolation” on page 1326](#)

Key Path:	Input/Output, RF Output & Test Set Config, Multiport Adapter, Corrections, Properties
Remote Command:	[:SENSE] :MPADapter:CORREction:CSET [1 2 3 4 5 6 7 8 9 10 11 12 13 14 15 16 :X:SPACing LINear LOGarithmic [:SENSE] :MPADapter:CORREction:CSET [1 2 3 4 5 6 7 8 9 10 11 12 13 14 15 16 :X:SPACing?
Example:	:MPAD:CORR:CSET:X:SPAC LIN
Dependencies:	This menu selection does not have any effect unless Input/Output, More, RF Output & Test Set Config, Multiport Adapter, Multiport Adapter is set to the On state.
Preset:	Unaffected by a Preset. Set to Linear by Restore Input/Output Defaults.
State Saved:	Saved in instrument state.
Initial S/W Revision:	A.10.00
Help Map ID:	0

Common Measurement Functions 1

Interpolation

For each bucket processed by the application, all of the correction factors at the frequency of interest (center frequency of each bucket) are summed and added to the amplitude. All trace operations and post processing treat this post-summation value as the true signal to use.

To effect this correction, the goal, for any particular start and stop frequency, is to build a correction trace, whose number of points matches the current Sweep Points setting of the instrument, which will be used to apply corrections on a bucket by bucket basis to the data traces.

For amplitudes that lie between two user specified frequency points, we interpolate to determine the amplitude value. You may select either linear or logarithmic interpolation between the frequencies.

If we interpolate on a log scale, we assume that the line between the two points is a straight line on the log scale. For example, let's say the two points are (2,4) and (20,1). A straight line between them on a log scale looks like:

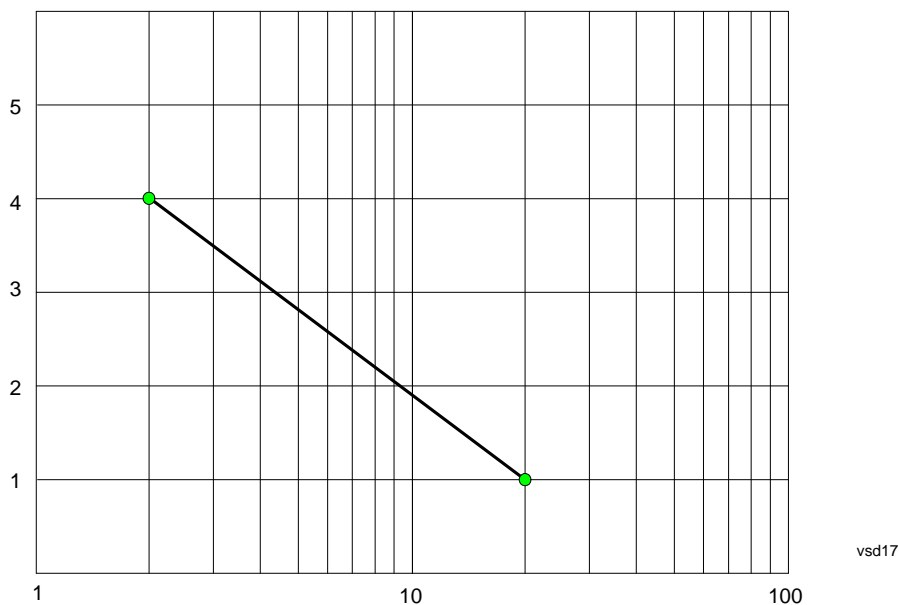

On a linear scale (like that of the spectrum analyzer), this translates to:

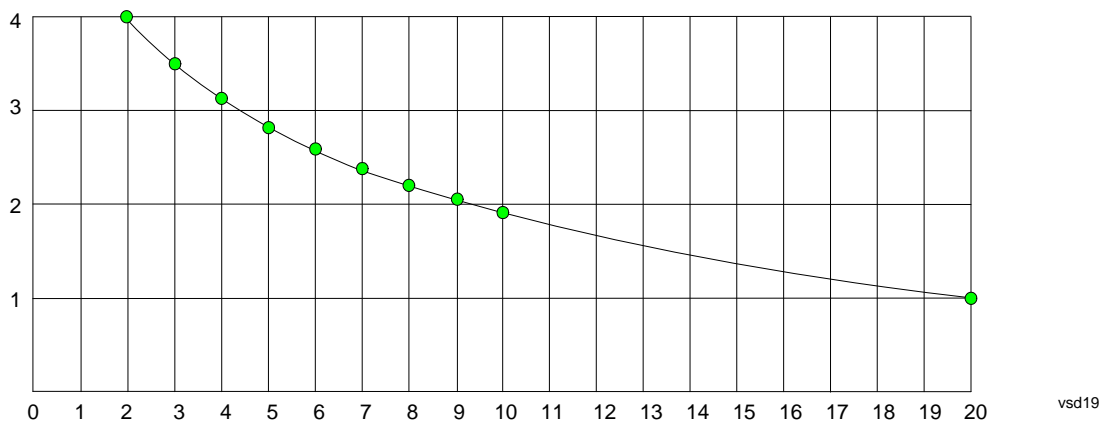

On the other hand, if we interpolate on a linear scale, we assume that the two points are connected by a straight line on the linear scale, as below:

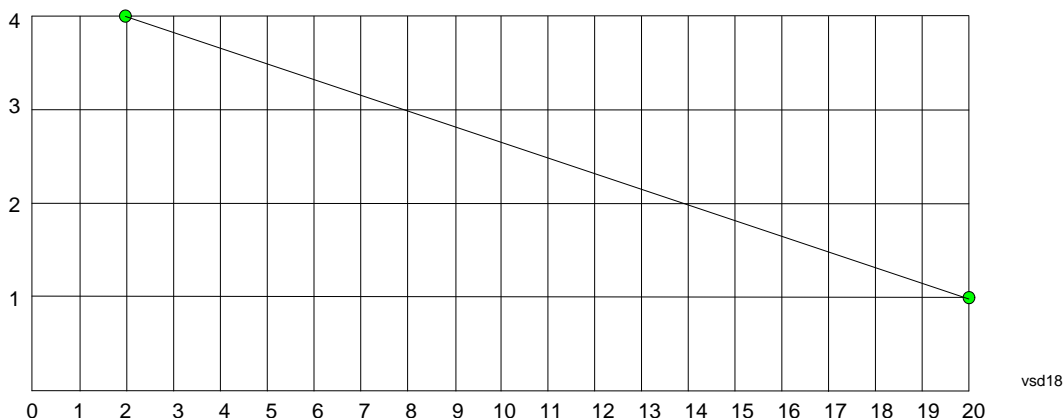

The correction to be used for each bucket is taken from the interpolated correction curve at the center of the bucket.

Description

Sets an ASCII description field which will be stored in an exported file. Can be displayed in the active function area by selecting as the active function, if desired to be in a screen dump.

Key Path:	Input/Output, RF Output & Test Set Config, Multiport Adapter, Corrections, Properties
Remote Command:	[:SENSE] :MPADapter:CORRection:CSET [1 2 3 4 5 6 7 8 9 10 11 12 13 14 15 16 :DESCription "text" [:SENSE] :MPADapter:CORRection:CSET [1 2 3 4 5 6 7 8 9 10 11 12 13 14 15 16 :DESCription?
Example:	:MPAD:CORR:CSET:DESC "11941A Antenna correction"
Notes:	45 chars max; may not fit on display if max chars used
Dependencies:	This menu selection does not have any effect unless Input/Output, More, RF Output & Test Set Config, Multiport Adapter, Multiport Adapter is set to the On state.
Preset:	Unaffected by a Preset. Set to empty by Restore Input/Output Defaults
State Saved:	Saved in instrument state.
Initial S/W Revision:	A.10.00
Help Map ID:	0

Comment

Sets an ASCII comment field which will be stored in an exported file. Can be displayed in the active function area by selecting as the active function, if desired to be in a screen dump.

Key Path:	Input/Output, RF Output & Test Set Config, Multiport Adapter, Corrections, Properties
-----------	--

Common Measurement Functions 1

Remote Command:	[:SENSe] :MPADapter:CORRection:CSET [1] 2 3 4 5 6 7 8 9 10 11 12 13 14 15 16 :COMMeNt "text" [:SENSe] :MPADapter:CORRection:CSET [1] 2 3 4 5 6 7 8 9 10 11 12 13 14 15 16 :COMMeNt ?
Example:	:MPAD:CORR:CSET:COMM "this is a comment"
Notes:	45 chars max; may not fit on display if max chars used
Preset:	Unaffected by Preset. Set to empty by Restore Input/Output Defaults
State Saved:	Saved in instrument state
Initial S/W Revision:	A.10.00
Help Map ID:	0

RF Port

Maps one of the sets of corrections to one of the IO ports.

Key Path:	Input/Output, RF Output & Test Set Config, Multiport Adapter, Corrections, Properties
Mode:	SEQAN
Remote Command:	[:SENSe] :MPADapter:CORRection:CSET [1] 2 3 4 5 6 7 8 9 10 11 12 13 14 15 16 :RF:PORT RFIO RFIO1 RFIO2 RFIO3 RFIO4 RFIO5 RFIO6 RFIO7 [:SENSe] :MPADapter:CORRection:CSET [1] 2 3 4 5 6 7 8 9 10 11 12 13 14 15 16 :RF:PORT ?
Example:	:MPAD:CORR:CSET:RF:PORT RFIO0
Notes:	
Dependencies:	Only available in EXT
Couplings:	
Preset:	Unaffected by Preset. Set to RF by Restore Input/Output Defaults
State Saved:	Saved in State
Backwards Compatibility SCPI:	
Initial S/W Revision:	A.10.00
Help Map ID:	0

RFIO0

The port to which the current corrections are applied. Pressing this key again allows the user access to the menu for specifying to which internal device and multiport adapter RF path the corrections for multiport adapter RFIO 0 are

applied.

Key Path:	Input/Output, RF Output & Test Set Config, Multiport Adapter, Corrections, Properties, RF Port
Remote Command:	[:SENSe] :MPADapter:CORRection:CSET [1] 2 3 4 5 6 7 8 9 10 11 12 13 14 15 16 :RF:PORT:RFIO0 SOURce ANALyzer BOTH [:SENSe] :MPADapter:CORRection:CSET [1] 2 3 4 5 6 7 8 9 10 11 12 13 14 15 16 :RF:PORT:RFIO0?
Example:	:MPAD:CORR:CSET:RF:PORT:RFIO0 BOTH
Preset:	Both
State Saved:	Saved in State
Initial S/W Revision:	A.10.0
Help Map ID:	0

Correct Source

Sets the corrections for the multiport adapter RFIO 0 port to be applied to the source.

Key Path:	Input/Output, RF Output & Test Set Config, Multiport Adapter, Corrections, Properties, RF Port, RFIO 0
Example:	:MPAD:CORR:CSET[1] 2 3 4 5 6 7 8 9 10 11 12 13 14 15 16:RF:PORT:RFIO0 SOUR
Readback:	"Correct Source"
Initial S/W Revision:	A.10.0
Help Map ID:	0

Correct Analyzer

Sets the corrections for the multiport adapter RFIO 0 port to be applied to the analyzer.

Key Path:	Input/Output, RF Output & Test Set Config, Multiport Adapter, Corrections, Properties, RF Port, RFIO 0
Example:	:MPAD:CORR:CSET[1] 2 3 4 5 6 7 8 9 10 11 12 13 14 15 16:RF:PORT:RFIO0 ANAL
Readback:	"Correct Analyzer"
Initial S/W Revision:	A.10.0
Help Map ID:	0

Common Measurement Functions 1

Correct Source and Analyzer

Sets the corrections for the multiport adapter RFIO 0 port to be applied to both the source and the analyzer.

Key Path:	Input/Output, RF Output & Test Set Config, Multiport Adapter, Corrections, Properties, RF Port, RFIO 0
Example:	:MPAD:CORR:CSET[1] 2 3 4 5 6 7 8 9 10 11 12 13 14 15 16:RF:PORT:RFIO0 BOTH
Readback:	"Correct Source and Analyzer"
Initial S/W Revision:	A.10.0
Help Map ID:	0

RFIO1

The port to which the current corrections will be applied. Pressing this key again allows the user access to the menu for specifying to which internal device and multiport adapter RF path the corrections for multiport adapter RFIO 1 are applied.

Key Path:	Input/Output, RF Output & Test Set Config, Multiport Adapter, Corrections, Properties, RF Port
Remote Command:	[:SENSE] :MPADapter:CORRection:CSET [1] 2 3 4 5 6 7 8 9 10 11 12 13 14 15 16 :RF:PORT:RFIO1 SOURCE ANALyzer BOTH [:SENSE] :MPADapter:CORRection:CSET [1] 2 3 4 5 6 7 8 9 10 11 12 13 14 15 16 :RF:PORT:RFIO1?
Example:	:MPAD:CORR:CSET:RF:PORT:RFIO1 BOTH
Preset:	Both
State Saved:	Saved in State
Initial S/W Revision:	A.10.0
Help Map ID:	0

Correct Source

Sets the corrections for the multiport adapter RFIO 1 port to be applied to the source.

Key Path:	Input/Output, RF Output & Test Set Config, Multiport Adapter, Corrections, Properties, RF Port, RFIO 1
Example:	:MPAD:CORR:CSET[1] 2 3 4 5 6 7 8 9 10 11 12 13 14 15 16:RF:PORT:RFIO1 SOUR
Readback:	"Correct Source"
Initial S/W Revision:	A.10.0
Help Map ID:	0

Correct Analyzer

Sets the corrections for the multiport adapter RFIO 1 port to be applied to the analyzer.

Key Path:	Input/Output, RF Output & Test Set Config, Multiport Adapter, Corrections, Properties, RF Port, RFIO 1
Example:	:MPAD:CORR:CSET[1] 2 3 4 5 6 7 8 9 10 11 12 13 14 15 16:RF:PORT:RFIO1 ANAL
Readback:	"Correct Analyzer"
Initial S/W Revision:	A.10.0
Help Map ID:	0

Correct Source and Analyzer

Sets the corrections for the multiport adapter RFIO 1 port to be applied to both the source and the analyzer.

Key Path:	Input/Output, RF Output & Test Set Config, Multiport Adapter, Corrections, Properties, RF Port, RFIO 1
Example:	:MPAD:CORR:CSET[1] 2 3 4 5 6 7 8 9 10 11 12 13 14 15 16:RF:PORT:RFIO1 BOTH
Readback:	"Correct Source and Analyzer"
Initial S/W Revision:	A.10.0
Help Map ID:	0

RFIO2

The port to which the current corrections are applied. Pressing this key again allows the user access to the menu for specifying to which internal device and multiport adapter RF path the corrections for multiport adapter RFIO 2 are applied.

Key Path:	Input/Output, RF Output & Test Set Config, Multiport Adapter, Corrections, Properties, RF Port
Remote Command:	[:SENSE] :MPADapter:CORREction:CSET [1] 2 3 4 5 6 7 8 9 10 11 12 13 14 15 16 :RF:PORT:RFIO2 SOURCE ANALyzer BOTH [:SENSE] :MPADapter:CORREction:CSET [1] 2 3 4 5 6 7 8 9 10 11 12 13 14 15 16 :RF:PORT:RFIO2?
Example:	:MPAD:CORR:CSET:RF:PORT:RFIO2 BOTH
Preset:	Both
State Saved:	Saved in State
Initial S/W Revision:	A.10.0
Help Map ID:	0

Common Measurement Functions 1

Correct Source

Sets the corrections for the multiport adapter RFIO 2 port to be applied to the source.

Key Path:	Input/Output, RF Output & Test Set Config, Multiport Adapter, Corrections, Properties, RF Port, RFIO 2
Example:	:MPAD:CORR:CSET[1] 2 3 4 5 6 7 8 9 10 11 12 13 14 15 16:RF:PORT:RFIO2 SOUR
Readback:	"Correct Source"
Initial S/W Revision:	A.10.0
Help Map ID:	0

Correct Analyzer

Sets the corrections for the multiport adapter RFIO 2 port to be applied to the analyzer.

Key Path:	Input/Output, RF Output & Test Set Config, Multiport Adapter, Corrections, Properties, RF Port, RFIO 2
Example:	:MPAD:CORR:CSET[1] 2 3 4 5 6 7 8 9 10 11 12 13 14 15 16:RF:PORT:RFIO2 ANAL
Readback:	"Correct Analyzer"
Initial S/W Revision:	A.10.0
Help Map ID:	0

Correct Source and Analyzer

Sets the corrections for the multiport adapter RFIO 2 port to be applied to both the source and the analyzer.

Key Path:	Input/Output, RF Output & Test Set Config, Multiport Adapter, Corrections, Properties, RF Port, RFIO 2
Example:	:MPAD:CORR:CSET[1] 2 3 4 5 6 7 8 9 10 11 12 13 14 15 16:RF:PORT:RFIO2 BOTH
Readback:	"Correct Source and Analyzer"
Initial S/W Revision:	A.10.0
Help Map ID:	0

RFIO3

The port to which the current corrections will be applied. Pressing this key again allows the user access to the menu for specifying to which internal device and multiport adapter RF path the corrections for multiport adapter RFIO 3 are applied.

Key Path:	Input/Output, RF Output & Test Set Config, Multiport Adapter, Corrections, Properties, RF Port
-----------	---

Remote Command:	[:SENSE] :MPADapter:CORRection:CSET [1] 2 3 4 5 6 7 8 9 10 11 12 13 14 15 16 :RF:PORT:RFIO3 SOURce ANALyzer BOTH [:SENSe] :MPADapter:CORRection:CSET [1] 2 3 4 5 6 7 8 9 10 11 12 13 14 15 16 :RF:PORT:RFIO3?
Example:	:MPAD:CORR:CSET:RF:PORT:RFIO3 BOTH
Preset:	Both
State Saved:	Saved in State
Initial S/W Revision:	A.10.0
Help Map ID:	0

Correct Source

Sets the corrections for the multiport adapter RFIO 3 port to be applied to the source.

Key Path:	Input/Output, RF Output & Test Set Config, Multiport Adapter, Corrections, Properties, RF Port, RFIO 3
Example:	:MPAD:CORR:CSET[1] 2 3 4 5 6 7 8 9 10 11 12 13 14 15 16:RF:PORT:RFIO3 SOUR
Readback:	"Correct Source"
Initial S/W Revision:	A.10.0
Help Map ID:	0

Correct Analyzer

Sets the corrections for the multiport adapter RFIO 3 port to be applied to the analyzer.

Key Path:	Input/Output, RF Output & Test Set Config, Multiport Adapter, Corrections, Properties, RF Port, RFIO 3
Example:	:MPAD:CORR:CSET[1] 2 3 4 5 6 7 8 9 10 11 12 13 14 15 16:RF:PORT:RFIO3 ANAL
Readback:	"Correct Analyzer"
Initial S/W Revision:	A.10.0
Help Map ID:	0

Correct Source and Analyzer

Sets the corrections for the multiport adapter RFIO 3 port to be applied to both the source and the analyzer.

Key Path:	Input/Output, RF Output & Test Set Config, Multiport Adapter, Corrections, Properties, RF Port, RFIO 3
Example:	:MPAD:CORR:CSET[1] 2 3 4 5 6 7 8 9 10 11 12 13 14 15 16:RF:PORT:RFIO3 BOTH

Common Measurement Functions 1

Readback:	"Correct Source and Analyzer"
Initial S/W Revision:	A.10.0
Help Map ID:	0

RFIO4

The port to which the current corrections are applied. Pressing this key again allows the user access to the menu for specifying to which internal device and multiport adapter RF path the corrections for multiport adapter RFIO 4 are applied.

Key Path:	Input/Output, RF Output & Test Set Config, Multiport Adapter, Corrections, Properties, RF Port
Remote Command:	[:SENSe] :MPADapter:CORRection:CSET [1] 2 3 4 5 6 7 8 9 10 11 12 13 14 15 16 :RF:PORT:RFIO4 SOURce ANALyzer BOTH [:SENSe] :MPADapter:CORRection:CSET [1] 2 3 4 5 6 7 8 9 10 11 12 13 14 15 16 :RF:PORT:RFIO4?
Example:	:MPAD:CORR:CSET:RF:PORT:RFIO4 BOTH
Preset:	Both
State Saved:	Saved in State
Initial S/W Revision:	A.10.0
Help Map ID:	0

Correct Source

Sets the corrections for the multiport adapter RFIO 4 port to be applied to the source.

Key Path:	Input/Output, RF Output & Test Set Config, Multiport Adapter, Corrections, Properties, RF Port, RFIO 4
Example:	:MPAD:CORR:CSET[1] 2 3 4 5 6 7 8 9 10 11 12 13 14 15 16:RF:PORT:RFIO4 SOUR
Readback:	"Correct Source"
Initial S/W Revision:	A.10.0
Help Map ID:	0

Correct Analyzer

Sets the corrections for the multiport adapter RFIO 4 port to be applied to the analyzer.

Key Path:	Input/Output, RF Output & Test Set Config, Multiport Adapter, Corrections, Properties, RF Port, RFIO 4
Example:	:MPAD:CORR:CSET[1] 2 3 4 5 6 7 8 9 10 11 12 13 14 15 16:RF:PORT:RFIO4 ANAL
Readback:	"Correct Analyzer"

Initial S/W Revision:	A.10.0
Help Map ID:	0

Correct Source and Analyzer

Sets the corrections for the multiport adapter RFIO 4 port to be applied to both the source and the analyzer.

Key Path:	Input/Output, RF Output & Test Set Config, Multiport Adapter, Corrections, Properties, RF Port, RFIO 4
Example:	:MPAD:CORR:CSET[1] 2 3 4 5 6 7 8 9 10 11 12 13 14 15 16:RF:PORT:RFIO4 BOTH
Readback:	"Correct Source and Analyzer"
Initial S/W Revision:	A.10.0
Help Map ID:	0

RFIO5

The port to which the current corrections are applied. Pressing this key again allows the user access to the menu for specifying to which internal device and multiport adapter RF path the corrections for multiport adapter RFIO 5 are applied.

Key Path:	Input/Output, RF Output & Test Set Config, Multiport Adapter, Corrections, Properties, RF Port
Remote Command:	[:SENSE] :MPADapter:CORRection:CSET [1] 2 3 4 5 6 7 8 9 10 11 12 13 14 15 16 :RF:PORT:RFIO5 SOURce ANALyzer BOTH [:SENSE] :MPADapter:CORRection:CSET [1] 2 3 4 5 6 7 8 9 10 11 12 13 14 15 16 :RF:PORT:RFIO5?
Example:	:MPAD:CORR:CSET:RF:PORT:RFIO5 BOTH
Preset:	Both
State Saved:	Saved in State
Initial S/W Revision:	A.10.0
Help Map ID:	0

Correct Source

Sets the corrections for the multiport adapter RFIO 5 port to be applied to the source.

Key Path:	Input/Output, RF Output & Test Set Config, Multiport Adapter, Corrections, Properties, RF Port, RFIO 5
Example:	:MPAD:CORR:CSET[1] 2 3 4 5 6 7 8 9 10 11 12 13 14 15 16:RF:PORT:RFIO5 SOUR
Readback:	"Correct Source"
Initial S/W Revision:	A.10.0

Common Measurement Functions 1

Help Map ID:	0
--------------	---

Correct Analyzer

Sets the corrections for the multiport adapter RFIO 5 port to be applied to the analyzer.

Key Path:	Input/Output, RF Output & Test Set Config, Multiport Adapter, Corrections, Properties, RF Port, RFIO 5
Example:	:MPAD:CORR:CSET[1] 2 3 4 5 6 7 8 9 10 11 12 13 14 15 16:RF:PORT:RFIO5 ANAL
Readback:	"Correct Analyzer"
Initial S/W Revision:	A.10.0
Help Map ID:	0

Correct Source and Analyzer

Sets the corrections for the multiport adapter RFIO 5 port to be applied to both the source and the analyzer.

Key Path:	Input/Output, RF Output & Test Set Config, Multiport Adapter, Corrections, Properties, RF Port, RFIO 5
Example:	:MPAD:CORR:CSET[1] 2 3 4 5 6 7 8 9 10 11 12 13 14 15 16:RF:PORT:RFIO5 BOTH
Readback:	"Correct Source and Analyzer"
Initial S/W Revision:	A.10.0
Help Map ID:	0

RFIO6

The port to which the current corrections are applied. Pressing this key again allows the user access to the menu for specifying to which internal device and multiport adapter RF path the corrections for multiport adapter RFIO 6 are applied.

Key Path:	Input/Output, RF Output & Test Set Config, Multiport Adapter, Corrections, Properties, RF Port, Page 2
Remote Command:	[:SENSe] :MPADapter:CORRection:CSET[1] 2 3 4 5 6 7 8 9 10 11 12 13 14 15 16 :RF:PORT:RFIO6 SOURce ANALyzer BOTH [:SENSe] :MPADapter:CORRection:CSET[1] 2 3 4 5 6 7 8 9 10 11 12 13 14 15 16 :RF:PORT:RFIO6?
Example:	:MPAD:CORR:CSET:RF:PORT:RFIO6 BOTH
Preset:	Both
State Saved:	Saved in State
Initial S/W Revision:	A.10.0
Help Map ID:	0

Correct Source

Sets the corrections for the multiport adapter RFIO 6 port to be applied to the source.

Key Path:	Input/Output, RF Output & Test Set Config, Multiport Adapter, Corrections, Properties, RF Port, RFIO 6
Example:	:MPAD:CORR:CSET[1] 2 3 4 5 6 7 8 9 10 11 12 13 14 15 16:RF:PORT:RFIO6 SOUR
Readback:	"Correct Source"
Initial S/W Revision:	A.10.0
Help Map ID:	0

Correct Analyzer

Sets the corrections for the multiport adapter RFIO 6 port to be applied to the analyzer.

Key Path:	Input/Output, RF Output & Test Set Config, Multiport Adapter, Corrections, Properties, RF Port, RFIO 6
Example:	:MPAD:CORR:CSET[1] 2 3 4 5 6 7 8 9 10 11 12 13 14 15 16:RF:PORT:RFIO6 ANAL
Readback:	"Correct Analyzer"
Initial S/W Revision:	A.10.0
Help Map ID:	0

Correct Source and Analyzer

Sets the corrections for the multiport adapter RFIO 6 port to be applied to both the source and the analyzer.

Key Path:	Input/Output, RF Output & Test Set Config, Multiport Adapter, Corrections, Properties, RF Port, RFIO 6
Example:	:MPAD:CORR:CSET[1] 2 3 4 5 6 7 8 9 10 11 12 13 14 15 16:RF:PORT:RFIO6 BOTH
Readback:	"Correct Source and Analyzer"
Initial S/W Revision:	A.10.0
Help Map ID:	0

RFIO7

The port to which the current corrections are applied. Pressing this key again allows the user access to the menu for specifying to which internal device and multiport adapter RF path the corrections for multiport adapter RFIO 7 are applied.

Key Path:	Input/Output, RF Output & Test Set Config, Multiport Adapter, Corrections, Properties, RF Port, Page 2
-----------	---

Common Measurement Functions 1

Remote Command:	[:SENSe] :MPADapter:CORRection:CSET [1] 2 3 4 5 6 7 8 9 10 11 12 13 14 15 16 :RF:PORT:RFIO7 SOURce ANALyzer BOTH [:SENSe] :MPADapter:CORRection:CSET [1] 2 3 4 5 6 7 8 9 10 11 12 13 14 15 16 :RF:PORT:RFIO7?
Example:	:MPAD:CORR:CSET:RF:PORT:RFIO7 BOTH
Preset:	Both
State Saved:	Saved in State
Initial S/W Revision:	A.10.0
Help Map ID:	0

Correct Source

Sets the corrections for the multiport adapter RFIO 7 port to be applied to the source.

Key Path:	Input/Output, RF Output & Test Set Config, Multiport Adapter, Corrections, Properties, RF Port, RFIO 7
Example:	:MPAD:CORR:CSET[1] 2 3 4 5 6 7 8 9 10 11 12 13 14 15 16:RF:PORT:RFIO7 SOUR
Readback:	"Correct Source"
Initial S/W Revision:	A.10.0
Help Map ID:	0

Correct Analyzer

Sets the corrections for the multiport adapter RFIO 7 port to be applied to the analyzer.

Key Path:	Input/Output, RF Output & Test Set Config, Multiport Adapter, Corrections, Properties, RF Port, RFIO 7
Example:	:MPAD:CORR:CSET[1] 2 3 4 5 6 7 8 9 10 11 12 13 14 15 16:RF:PORT:RFIO7 ANAL
Readback:	"Correct Analyzer"
Initial S/W Revision:	A.10.0
Help Map ID:	0

Correct Source and Analyzer

Sets the corrections for the multiport adapter RFIO 7 port to be applied to both the source and the analyzer.

Key Path:	Input/Output, RF Output & Test Set Config, Multiport Adapter, Corrections, Properties, RF Port, RFIO 7
Example:	:MPAD:CORR:CSET[1] 2 3 4 5 6 7 8 9 10 11 12 13 14 15 16:RF:PORT:RFIO7 BOTH

Readback:	"Correct Source and Analyzer"
Initial S/W Revision:	A.10.0
Help Map ID:	0

Table Editor

Edit

Invokes the integrated editing facility for this correction set. See description in section [“Table Editor” on page 1339](#).

When entering the menu, the editor window turns on, the selected correction is turned **On**, **Apply Corrections** is set to **On**, the amplitude scale is set to **Log**, and the Amplitude Correction (“Ampcor”) trace is displayed. The actual, interpolated correction trace is shown in green for the selected correction. Note that since the actual interpolated correction is shown, the correction trace may have some curvature to it. This trace represents only the correction currently being edited, rather than the total, accumulated amplitude correction for all amplitude corrections which are currently on, although the total, accumulated correction for all corrections which are turned on is still applied to the data traces.

Because corrections data is always in dB, but the Y-axis of the analyzer is in absolute units, it is necessary to establish a reference line for display of the Corrections data. The reference line is halfway up the display and represents 0 dB of correction. It is labeled “0 dB CORREC”. It is drawn in blue. (0,0,255) and is three pixels high. The green correction trace is drawn after all other traces and this reference blue line, so it sits “on top” of them.

Corrections data is always in dB. Whatever dB value appears in the correction table represents the correction to be applied to that trace at that frequency. So if a table entry shows 30 dB that means we ADD 30 dB to each trace to correct it before displaying it. By definition all points are connected. If a gap is desired for corrections data, enter 0 dB.

Note that a well-designed Corrections array should start at 0 dB and end at 0 dB. This is because whatever the high end point is will be extended to the top frequency of the instrument, and whatever the low end point is will be extended down to 0 Hz. So for a Corrections array to have no effect outside its range, you should start and end the array at 0 dB.

NOTE The table editor will only operate properly if the analyzer is sweeping, because its updates are tied to the sweep system. Thus, you should not try to use the editor in single sweep, and it will be sluggish during compute-intensive operations like narrow-span FFT sweeps.

When exiting the edit menu (by using the **Return** key or by pressing an instrument front-panel key), the editor window turns off and the Ampcor trace is no longer displayed; however, **Apply Corrections** remains **On**, any correction that was on while in the editor remains on, and the amplitude scale returns to its previous setting.

Corrections arrays are not affected by a Preset, because they are in the Input/Output system. They also survive shutdown and restarting of the analyzer application, which means they will survive a power cycle.

When editing a correction, the editor remembers which correction and which element in the correction array you were editing, and returns you to that correction and that element when you return to the editor after leaving it.

Key Path:	Input/Output, RF Output & Test Set Config, Multiport Adapter, Corrections
-----------	--

Common Measurement Functions 1

Initial S/W Revision:	A.10.00
Help Map ID:	0

Navigate

Lets you move through the table to edit the desired point.

Key Path:	Input/Output, RF Output & Test Set Config, Multiport Adapter, Corrections, Edit
Notes:	There is no value readback on the key
Min:	1
Max:	2000
Initial S/W Revision:	A.10.00
Help Map ID:	0

Frequency

Lets you edit the frequency of the current row.

Key Path:	Input/Output, RF Output & Test Set Config, Multiport Adapter, Corrections, Edit
Notes:	There is no value readback on the key.
Min:	0
Max:	1 THz
Initial S/W Revision:	A.10.00
Help Map ID:	0

Amplitude

Lets you edit the Amplitude of the current row.

Key Path:	Input/Output, RF Output & Test Set Config, Multiport Adapter, Corrections, Edit
Notes:	There is no value readback on the key.
Min:	-1000 dB
Max:	1000 dB
Initial S/W Revision:	A.10.00
Help Map ID:	0

Insert Point Below

Inserts a point below the current point. The new point is a copy of the current point and becomes the current point.

The new point is not yet entered into the underlying table, and the data in the row is displayed in light gray.

Key Path:	Input/Output, RF Output & Test Set Config, Multiport Adapter, Corrections, Edit
Initial S/W Revision:	A.10.00
Help Map ID:	0

Delete Point

Deletes the currently-selected point, whether or not that point is being edited, and selects the Navigate functionality. The point following the currently-selected point (or the point preceding if there is none) will be selected.

Key Path:	Input/Output, RF Output & Test Set Config, Multiport Adapter, Corrections, Edit
Initial S/W Revision:	A.10.00
Help Map ID:	0

Scale X Axis

Matches the X Axis to the selected Correction, as well as possible. Sets the Start and Stop Frequency to contain the minimum and maximum Frequency of the selected Correction. The range between Start Frequency and Stop Frequency is 12.5% above the range between the minimum and maximum Frequency, so that span exceeds this range by one graticule division on either side. If in zero-span, or there is no data in the Ampcor table, or the frequency range represented by the table is zero, no action is taken. Standard clipping rules apply if the value in the table is outside the allowable range for the X axis.

Key Path:	Input/Output, RF Output & Test Set Config, Multiport Adapter, Corrections, Edit
Dependencies:	If either the first or last point in the array is outside the frequency range of the current input, an error message is generated: “-221. Settings conflict; Start or Stop Freq out of range for current input settings”
Initial S/W Revision:	A.10.00
Help Map ID:	0

Delete Correction

Deletes the correction values for this set. When this key is pressed a prompt is placed on the screen that says “Please press Enter or OK key to delete correction. Press ESC or Cancel to close this dialog.” The deletion is only performed if you press OK or Enter.

Key Path:	Input/Output, RF Output & Test Set Config, Multiport Adapter, Corrections
Remote Command:	[:SENSE] :MPADapter:CORRection:CSET [1] 2 3 4 5 6 7 8 9 10 11 12 13 14 15 16 :DELeTe

Common Measurement Functions 1

Example:	MPAD:CORR:CSET:DEL MPAD:CORR:CSET1:DEL MPAD:CORR:CSET4:DEL
Notes:	Pressing this key when no corrections are present is accepted without error.
Initial S/W Revision:	A.10.00
Help Map ID:	0

Correction On/Off

Apply Corrections

Applies amplitude corrections which are marked as ON to the measured data. If this is set to OFF, then no amplitude correction sets will be used, regardless of their individual on/off settings. If set to ON, the corrections that are marked as ON (see [“Correction On/Off” on page 1321](#)) are used.

Key Path:	Input/Output, RF Output & Test Set Config, Multiport Adapter, Corrections
Remote Command:	[:SENSe] :MPADapter:CORRection:CSET:ALL [:STATe] ON OFF 1 0 [:SENSe] :MPADapter:CORRection:CSET:ALL [:STATe] ?
Example:	SENS:MPAD:CORR:CSET:ALL OFF This command makes sure that no amplitude corrections are applied, regardless of their individual on/off settings.
Preset:	Not affected by Preset. Set to OFF by Restore Input/Output Defaults
State Saved:	Saved in instrument state.
Initial S/W Revision:	A.10.00
Help Map ID:	0

Delete All Corrections

Erases all correction values for all 16 Amplitude Correction sets.

When this key is pressed a prompt is placed on the screen that says “Please press Enter or OK key to delete all corrections. Press ESC or Cancel to close this dialog.” The deletion is only performed if you press OK or Enter.

Key Path:	Input/Output, RF Output & Test Set Config, Multiport Adapter, Corrections
Remote Command:	[:SENSe] :MPADapter:CORRection:CSET:ALL:DELeTe
Example:	MPAD:CORR:CSET:ALL:DEL
Initial S/W Revision:	A.10.00
Help Map ID:	0

Set (Replace) Data (Remote Command Only)

The command takes an ASCII series of alternating frequency and amplitude points, each value separated by commas.

The values sent in the command will totally replace all existing correction points in the specified set.

An Ampcor array can contain 2000 points maximum.

Remote Command:	[:SENSE]:MPADapter:CORRection:CSET[1] 2 3 4 5 6 7 8 9 10 11 12 13 14 15 16:DATA <freq>, <ampl>, . . . [:SENSE]:MPADapter:CORRection:CSET[1] 2 3 4 5 6 7 8 9 10 11 12 13 14 15 16:DATA?
Example:	MPAD:CORR:CSET[1] 2 3 4 5 6 7 8 9 10 11 12 13 14 15 16:DATA 10000000,-1.0,20000000,1.0 This defines two correction points at (10 MHz, -1.0 dB) and (20 MHz, 1.0 dB) for correction set 1.
Preset:	Empty after Restore Input/Output Defaults. Survives a shutdown or restart of analyzer application (including a power cycle).
State Saved:	Saved in instrument state.
Min:	Freq: 0 Hz Amptd: -1000 dBm
Max:	Freq: 1 THz Amptd: +1000 dBm
Initial S/W Revision:	A.10.00
Help Map ID:	0

Merge Correction Data (Remote Command Only)

The command takes an ASCII series of alternating frequency and amplitude points, each value separated by commas. The difference between this command and Set Data is that this merges new correction points into an existing set.

Any new point with the same frequency as an existing correction point will replace the existing point's amplitude with that of the new point.

An Ampcor array can contain 2000 total points, maximum.

Remote Command:	[:SENSE]:MPADapter:CORRection:CSET[1] 2 3 4 5 6 7 8 9 10 11 12 13 14 15 16:DATA:MERGe <freq>, <ampl>, . . .
Example:	MPAD:CORR:CSET[1] 2 3 4 5 6 7 8 9 10 11 12 13 14 15 16:DATA:MERGE 15000000,-5.0,25000000,5.0 This adds two correction points at (15 MHz, -5.0 dB) and (25 MHz, 5.0 dB) to whatever values already exist in correction set 1.
Preset:	Empty after Restore Input/Output Defaults. Survives shutdown/restart of analyzer application (including power cycle)

Common Measurement Functions 1

Min:	Freq: 0 Hz Amptd: -1000 dBm
Max:	Freq: 1 THz Amptd: +1000 dBm
Initial S/W Revision:	A.10.00
Help Map ID:	0

Output Config

Accesses keys that configure various output settings, like the frequency reference output, trigger output and analog output.

Key Path:	Input/Output
Backwards Compatibility Notes:	1. In ESA there was not a user interface to enable the Video Output (Analog Output), Trigger Output, or Gate Output. In the X-Series each of these physical connectors requires configuration, thus the user interface has been added for X-Series, along with the potential for an output you think is always on to be switched off.
Initial S/W Revision:	Prior to A.02.00
Help Map ID:	3133

Trig Out (1 and 2)

Select the type of output signal that will be output from the rear panel Trig 1 Out or Trig 2 Out connectors.

Key Path:	Input/Output, Output Config
Remote Command:	:TRIGger TRIGger1 TRIGger2[:SEquence]:OUTPut HSWP MEASuring MAIN GATE GTRigger OEVen SPOint SSweep S SETtled S1Marker S2Marker S3Marker S4Marker OFF :TRIGger TRIGger1 TRIGger2[:SEquence]:OUTPut?
Example:	TRIG:OUTP HSWP TRIG2:OUTP GATE
Dependencies:	The second Trigger output (Trig 2 Out) does not appear in all models; in models that do not support it, the Trig 2 Out key is blanked, and sending the SCPI command for this output generates an error, "Hardware missing; Not available for this model number" In models that do not support the Trigger 2 output, this error is returned if trying to set Trig 2 Out and a query of Trig 2 Out returns OFF.
Dependencies:	SSweep SSETtled S1Marker S2Marker S3Marker S4Marker are only available for the source in the EXT.

Preset:	Trigger 1: Sweeping (HSWP) Trigger 2: Gate This is unaffected by a Preset but is preset to the above values on a "Restore Input/Output Defaults" or "Restore System Defaults->All"
State Saved:	Saved in instrument state
Initial S/W Revision:	Prior to A.02.00
Help Map ID:	3135

Off

Selects no signal to be output to the Trig 1 Out or Trig 2 Out connector.

Key Path:	Input/Output, Output Config, Trig 1/2 Output
Example:	TRIG1:OUTP OFF
Readback:	Off
Initial S/W Revision:	Prior to A.02.00
Help Map ID:	3141

Polarity

Sets the output to the Trig 1 Out or Trig 2 Out connector to trigger on either the positive or negative polarity.

Key Path:	Input/Output, Output Config, Trig 1/2 Output
Remote Command:	:TRIGger TRIGger1 TRIGger2[:SEquence]:OUTPut:POLarity POSitive NEGative :TRIGger TRIGger1 TRIGger2[:SEquence]:OUTPut:POLarity?
Example:	TRIG1:OUTP:POL POS
Preset:	This is unaffected by a Preset but is set to POSitive on a "Restore Input/Output Defaults" or "Restore System Defaults->All"
State Saved:	Saved in instrument state
Initial S/W Revision:	Prior to A.02.00
Help Map ID:	3142

Sweeping (HSWP)

Selects the Sweeping Trigger signal to be output to the Trig 1 Out or Trig 2 Out connector when a measurement is made. This signal has historically been known as "HSWP" (High = Sweeping), and is 5 V TTL level with 50 ohm output impedance."

Key Path:	Input/Output, Output Config, Trig 1/2 Output
-----------	---

Common Measurement Functions 1

Example:	TRIG1:OUTP HSWP
Readback:	Sweeping
Initial S/W Revision:	Prior to A.02.00
Help Map ID:	3136

Measuring

Selects the Measuring trigger signal to be output to the Trig 1 Out or Trig 2 Out connector. This signal is true while the Measuring status bit is true.

Key Path:	Input/Output, Output Config, Trig 1/2 Output
Example:	TRIG1:OUTP MEAS
Readback:	Measuring
Initial S/W Revision:	Prior to A.02.00
Help Map ID:	3137

Main Trigger

Selects the current instrument trigger signal to be output to the Trig 1 Out or Trig 2 Out connector.

Key Path:	Input/Output, Output Config, Trig 1/2 Output
Example:	TRIG1:OUTP MAIN
Readback:	Main Trigger
Initial S/W Revision:	Prior to A.02.00
Help Map ID:	3200

Gate Trigger

Selects the gate trigger signal to be output to the Trig 1 Out or Trig 2 Out connector. This is the source of the gate timing, not the actual gate signal.

Key Path:	Input/Output, Output Config, Trig 1/2 Output
Example:	TRIG1:OUTP GTR
Readback:	Gate Trigger
Initial S/W Revision:	Prior to A.02.00
Help Map ID:	3138

Gate

Selects the gate signal to be output to the Trig 1 Out or Trig 2 Out connector. The gate signal has been delayed and its length determined by delay and length settings. When the polarity is positive, a high on the Trig 1 Out or Trig 2

Out represents the time the gate is configured to pass the signal.

Key Path:	Input/Output, Output Config, Trig 1/2 Output
Example:	TRIG1:OUTP GATE
Readback:	Gate
Initial S/W Revision:	Prior to A.02.00
Help Map ID:	3139

Odd/Even Trace Point

Selects either the odd or even trace points as the signal to be output to the Trig 1 Out or Trig 2 Out connector when performing swept spectrum analysis. When the polarity is positive, this output goes high during the time the test set is sweeping past the first point (Point 0) and every other following trace point. The opposite is true if the polarity is negative.

Key Path:	Input/Output, Output Config, Trig 1/2 Output
Example:	TRIG1:OUTP OEV
Readback:	Odd/Even
Initial S/W Revision:	Prior to A.02.00
Help Map ID:	3140

Source Point Trigger

Selects the gate signal to be output to the Trig 1 Out or Trig 2 Out connector for use as the Point Trigger when operating an external source in Tracking mode. When Ext Trigger 1 is selected as the Point Trigger under Source, the Source Point Trigger under Trig1 Out automatically gets selected. Similarly, when Ext Trigger 2 is selected as the Point Trigger under Source, the Source Point Trigger key under Trig2 Out automatically gets selected

Key Path:	Input/Output, Output Config, Trig 1/2 Output
Example:	TRIG1:OUTP SPO
Readback:	Source Point
Initial S/W Revision:	Prior to A.02.00
Help Map ID:	3178

Source Marker 1

This key is only available in the EXT.

Trigger output at marker 1 in current playing Waveform file.

Key Path:	Input/Output, Output Config, Trig 1/2 Output
Example:	:TRIG1:OUTP S1M
ReadBack:	Marker 1

Common Measurement Functions 1

Initial S/W Revision:	A.05.01
Help Map ID:	30019

Source Marker 2

This key is only available in the EXT.

Trigger output at marker 2 in current playing Waveform file.

Key Path:	Input/Output, Output Config, Trig 1/2 Output
Example:	:TRIG1:OUTP S2M
ReadBack:	Marker 2
Initial S/W Revision:	A.05.01
Help Map ID:	30020

Source Marker 3

This key is only available in the EXT.

Trigger output at marker 3 in current playing Waveform file.

Key Path:	Input/Output, Output Config, Trig 1/2 Output
Example:	:TRIG1:OUTP S3M
ReadBack:	Marker 3
Initial S/W Revision:	A.05.01
Help Map ID:	30021

Source Marker 4

This key is only available in the EXT.

Trigger output at marker 4 in current playing Waveform file.

Key Path:	Input/Output, Output Config, Trig 1/2 Output
Example:	:TRIG1:OUTP S4M
ReadBack:	Marker 4
Initial S/W Revision:	A.05.01
Help Map ID:	30022

Analog Out

This menu lets you control which signal is fed to the “Analog Out” connector on the test set rear panel.

See “More Information” on page 1349

Key Path:	Input/Output, Output Config
Remote Command:	:OUTPut:ANALog OFF SVIDeo LOGVideO LINVideO DAUDio :OUTPut:ANALog?
Example:	OUTP:ANAL SVIDeo ! causes the analog output type to be Screen Video
Preset:	OFF
Preset:	This is unaffected by Preset but is set to DAUDio on a "Restore Input/Output Defaults" or "Restore System Defaults->All
State Saved:	Saved in Input/Output State
Readback line:	1-of-N selection [variable]
Backwards Compatibility Notes:	Prior to A.04.00, OFF was the default functionality except when in the Analog Demod application or with Tune and Listen, in which case it was DAUDio, and there was no selection menu. So for backwards compatibility with earlier X-Series firmware versions, Auto (:OUTP:ANAL:AUTO ON) will duplicate the prior behavior. The DNWB and SANalyzer parameters, which were legal in PSA but perform no function in the X-Series, are accepted without error.
Initial S/W Revision:	A.04.00
Help Map ID:	3143

More Information

The table below gives the range for each output.

Analog Out	Nominal Range exc. (10% overrange)	Scale Factor	Notes
Off	0 V		
Screen Video	0 – 1 V open circuit	10%/division	8566 compatible
Log Video	0 – 1 V terminated	1/(192.66 dB/V)	dB referenced to mixer level, 1V out for –10 dBm at the mixer.
Linear Video	0 – 1 V terminated	100%/V	Linear referenced to Ref Level, 1 V out for RF envelope at the Ref Level.
Demod Audio	(varies with test set setting)		

Auto

Selects the Auto state for the Analog Output menu. In this state, the Analog Output will automatically be set to the most sensible setting for the current mode or measurement.

If you make a selection manually from the Analog Out menu, this selection will remain in force until you change it

Common Measurement Functions 1

(or re-select Auto), even if you go to a mode or measurement for which the selected output does not apply.

Key Path:	Input/Output, Output Config, Analog Out
Remote Command:	:OUTPut:ANALog:AUTO OFF ON 0 1 :OUTPut:ANALog:AUTO?
Example:	OUTP:ANAL:AUTO ON
Preset:	ON
State Saved:	Saved in Input/Output State
Initial S/W Revision:	A.04.00
Help Map ID:	29995

Off

Turns off the analog output.

Key Path:	Input/Output, Output Config, Analog Out
Example:	OUTP:ANAL OFF ! causes the analog output to be off
Readback Text:	Off
Initial S/W Revision:	A.04.00
Help Map ID:	3144

Log Video (RF Envelope, Ref=Mixer Level)

Selects the analog output to be the log of the video signal. In this mode, the pre-detector data is output to the Analog Out connector with a Log scaling. The output is referenced to the current level at the mixer, does not depend on display settings like Reference Level or dB per division, and it is not influenced by the selected detector or any digital flatness corrections or trace post-processing (like Trace Averaging), but does change with input attenuation.

The output is designed so that full scale (1 V) corresponds to -10 dBm at the mixer. The full range (0-1 V) covers 192.66 dB ; thus, 0 V corresponds to -202.66 dBm at the mixer.

Key Path:	Input/Output, Output Config, Analog Out
Example:	OUTP:ANAL LOGV

Dependencies:	<p>Because the Log Video output uses one of the two IF processing channels, only one detector is available while Screen Video is selected. All active traces will change to use the same detector as the selected trace when Log Video is activated.</p> <p>Log Video output is not available while any EMI Detector is selected (Quasi Peak, RMS Average or EMI Average), because these detectors use both IF processing channels. Consequently, if the user chooses an EMI Detector, there will be no Log Video output.</p> <p>The output holds at its last value during an alignment, during a marker count, and during retrace (after a sweep and before the next sweep starts).</p> <p>This function depends on optional capability. The key will be blanked and the command will generate an “Option not available” error unless you have Option YAV licensed in your instrument.</p>
Couplings:	Log Video output changes while in FFT Sweeps, so for measurements that use exclusively FFT Sweeps, or if the user manually chooses FFT Sweeps, the Log Video output will look different than it does in swept mode.
Readback Text:	Log Video
Initial S/W Revision:	A.04.00
Help Map ID:	3146

Linear Video (RF Envelope, Ref=Ref Level)

Selects the analog output to be the envelope signal on a linear (voltage) scale. In this mode, the pre-detector data is output to the Analog Out connector with a Linear scaling. The output is based on the current Reference Level, and is not influenced by the selected detector or any digital flatness corrections or trace post-processing (like Trace Averaging).

The scaling is set so that 1 V output occurs with an instantaneous video level equal to the reference level, and 0 V occurs at the bottom of the graticule. This scaling gives you the ability to control the gain without having another setup control for the key. But it requires you to control the look of the display (the reference level) in order to control the analog output.

This mode is ideal for looking at Amplitude Modulated signals, as the linear envelope effectively demodulates the signal.

Key Path:	Input/Output, Output Config, Analog Out
Example:	OUTP:ANAL LINV

Common Measurement Functions 1

Dependencies:	<p>Because the Linear Video output uses one of the two IF processing channels, only one detector is available while Linear Video is selected. All active traces will change to use the same detector as the selected trace when Log Video is activated.</p> <p>Linear Video output is not available while any EMI Detector is selected (Quasi Peak, RMS Average or EMI Average), because these detectors use both IF processing channels. Consequently, if the user chooses an EMI Detector, there will be no Linear Video output.</p> <p>The output holds at its last value during an alignment and during a marker count and during retrace (after a sweep and before the next sweep starts).</p> <p>This function depends on optional capability; the key will be blanked and the command will generate an “Option not available” error unless you have Option YAV licensed in your instrument.</p>
Couplings:	Linear Video output changes while in FFT Sweeps, so for measurements that use exclusively FFT Sweeps, or if the user manually chooses FFT Sweeps, the Linear Video output will look different than it does in swept mode.
Readback Text:	Linear Video
Initial S/W Revision:	A.04.00
Help Map ID:	3147

Demod Audio

Selects the analog output to be the demodulation of the video signal.

When Demod Audio is selected, the demodulated audio signal appears at this output whenever the Analog Demod application is demodulating a signal.

When Analog Out is in the Auto state, this output is auto-selected when in the Analog Demod mode.

If any other Analog Output is manually selected when in the Analog Demod mode, a condition warning message appears.

Key Path:	Input/Output, Output Config, Analog Out
Example:	OUTP:ANAL DAUD
Dependencies:	<p>This key only appears if the Analog Demod application (N9063A), the N6141A or W6141A application, or Option EMC is installed and licensed, otherwise the key will be blanked and the command will generate an “Option not available” error.</p> <p>The output holds at its last value during an alignment and during a marker count. It is not held between sweeps, in order for Tune and Listen to work properly.</p> <p>When Demod Audio is the selected Analog Output:</p> <ul style="list-style-type: none"> • all active traces are forced to use the same detector. • CISPR detectors (QPD, EMI Avg, RMS Avg) are unavailable
Readback Text:	Demod Audio

Initial S/W Revision:	Prior to A.02.00 (this was the default functionality, and there was no selection)
Modified at S/W Revision:	A.04.00
Help Map ID:	3148

Digital Bus

This menu allows you to configure the LVDS connector located on the rear panel of the instrument. It is a unidirectional link of real time data at a 90 MSa/s rate. The ADC is sampling a 22.5 MHz IF.

The data that appears on this port is raw, uncorrected ADC samples, unless you have option RTL. With option RTL, you get fully corrected I/Q data.

This connector will only be active when the Narrowband IF Path is currently in use.

Key Path:	Input/Output, Output Config, Digital Out
Initial S/W Revision:	A.04.00
Help Map ID:	3559

Marker

See [“Marker Control Mode” on page 1354](#).

See [“Setting the Marker X-axis Value” on page 1354](#).

See [“Setting the Marker X Position in Trace Points” on page 1354](#).

See [“Setting the Marker Y-axis Value” on page 1356](#).

The Marker key accesses the Marker menu. A marker can be placed on a trace to allow the value of the trace at the marker point to be determined precisely. The functions in this menu include a 1-of-N selection of the control mode Normal, Delta, Fixed, or Off for the selected marker. If the selected marker is Off, pressing Marker sets it to Normal and places it at the center of the screen on the trace determined by the Marker Trace rules.

Markers may also be used in pairs to read the difference (or delta) between two data points. They can be used in Marker Functions to do advanced data processing, or to specify operating points in functions like Signal Track and N dB Points.

The SCPI command in the table below selects the marker and sets the marker control mode as described under **Normal**, **Delta**, **Fixed** and **Off**, below. All interactions and dependencies detailed under the key description are enforced when the remote command is sent.

Remote Command:	:CALCulate:MARKer [1] 2 3 4 5 6 7 8 9 10 11 12 :MODE POSITION DELTa FIXed OFF :CALCulate:MARKer [1] 2 3 4 5 6 7 8 9 10 11 12 :MODE?
Preset:	OFF (all markers)
State Saved:	The marker control mode is saved in instrument state

Common Measurement Functions 1

Backwards Compatibility SCPI:	:CALCulate:MARKer[1] 2 3 4 5 6 7 8 9 10 11 12:MODE SPAN BAND These parameters are aliased to POSition if sent. A query does not reflect them.
Initial S/W Revision:	Prior to A.02.00
Help Map ID:	3149

Marker Control Mode

Setting the Marker X-axis Value

The command below sets the marker X-axis value in the current marker X-axis scale unit. In each case the marker that is addressed becomes the selected marker. It has no effect (other than to cause the marker to become selected) if the control mode is **Off**, but it is the SCPI equivalent of entering an X value if the control mode is **Normal**, **Delta**, or **Fixed**.

Remote Command:	:CALCulate:MARKer[1] 2 3 4 5 6 7 8 9 10 11 12:X <freq> :CALCulate:MARKer[1] 2 3 4 5 6 7 8 9 10 11 12:X?
Notes:	<p>If no suffix is sent it will use the fundamental units for the current marker X-axis scale. If a suffix is sent that does not match the current marker X-axis scale unit, an invalid suffix error is generated.</p> <p>If the specified marker is Fixed and a Marker Function is on, a message is generated. If the key is pressed, an advisory message is generated. If the equivalent SCPI command is sent, this same message is generated as part of a “-221, Settings conflict” warning.</p> <p>The query returns the marker’s absolute X-axis value if the control mode is Normal or Fixed. It returns the offset from the marker’s reference marker if the control mode is Delta. The query is returned in the fundamental units for the current marker X-axis scale: Hz for Frequency and Inverse Time, seconds for Period and Time. If the marker is Off the response is not a number.</p>
Preset:	After a preset, if X is queried with no value sent first, the center of screen value is returned.
Min:	$-\infty$ (minus infinity)
Max:	$+\infty$ (plus infinity). X-Series marker values are not limited and do not clip
Default Unit:	Determined by X-axis scale
Backwards Compatibility SCPI:	:CALCulate:MARKer[1] 2 3 4:X:CENTer
Initial S/W Revision:	Prior to A.02.00
Help Map ID:	3150

Setting the Marker X Position in Trace Points

The command below sets the marker X position in trace points. It has no effect if the marker control

mode is **Off**. But it is the SCPI equivalent of entering a value if the control mode is **Normal** or **Delta** or **Fixed** – except the setting is in trace points rather than X-axis scale units.

NOTE The entered value in Trace Points is immediately translated into the current X-axis scale units for setting the value of the marker. The marker’s value in X-axis scale Units, NOT trace points, are preserved if a change is made to the X-axis scale settings. Thus, if you use this command to place a marker on bucket 500, which happens at that time to correspond to 13 GHz, and then you change the Start Frequency so that bucket 500 is no longer 13 GHz, the marker will stay at 13 GHz, NOT at bucket 500.

Remote Command:	:CALCulate:MARKer [1] 2 3 4 5 6 7 8 9 10 11 12 :X:POSition <real> :CALCulate:MARKer [1] 2 3 4 5 6 7 8 9 10 11 12 :X:POSition?
Notes:	If the specified marker is Fixed and a Marker Function is on, a message is generated. If the key is pressed, an advisory message is generated. If the equivalent SCPI command is sent, this same message is generated as part of a “-221, Settings conflict” warning. The query returns the marker’s absolute X-axis value in trace points if the control mode is Normal or Fixed . It returns the offset from the marker’s reference marker in trace points if the control mode is Delta . The value is returned as a real number, not an integer, corresponding to the translation from X-axis scale units to trace points
Preset:	After a preset, if X is queried with no value sent first, the center of screen value is returned. So if per default, the number of Trace points is 1001, the center value is 500.
Min:	0
Max:	Number of trace points – 1
Default Unit:	unitless
Backwards Compatibility SCPI:	:CALCulate:MARKer[1] 2 3 4:X:POSition:CENTer

Common Measurement Functions 1

Backwards Compatibility SCPI:	<p>The legacy command, <code>:CALCulate:MARKer[n]:X:POSition:CENTer <param></code> was used to control the center point between the Delta and Reference marker in trace points (buckets) in Span Pair mode. In the new system, this is equivalent to simply setting the marker position in trace points. So this command is aliased to the command <code>:CALCulate:MARKer[n]:X:POSition <param></code></p> <hr/> <p>NOTE The UP/DOWN parameters will increment/decrement by one bucket. This will require a conversion to buckets and back.</p>
Initial S/W Revision:	Prior to A.02.00
Help Map ID:	3151

Setting the Marker Y-axis Value

The command below selects the marker and sets the marker Y-axis value; the default unit is the current Y-axis unit. It has no effect (other than selecting the marker) unless the marker control mode is **Fixed**.

Remote Command:	<code>:CALCulate:MARKer [1] 2 3 4 5 6 7 8 9 10 11 12 :Y <real></code> <code>:CALCulate:MARKer [1] 2 3 4 5 6 7 8 9 10 11 12 :Y?</code>
Example:	<p>CALC:MARK2:MODE POS turns on marker 2 as a normal marker.</p> <p>CALC:MARK2:X 20 GHZ moves marker 2 to 20 GHz if X-axis scale is Frequency. If X-axis scale is Time, the -131 invalid suffix error is generated.</p>
Preset:	Trace value at center of screen. There is no way to predict what this will be after a preset.
Min:	- ∞ (minus infinity)
Max:	+ ∞ (plus infinity)
Initial S/W Revision:	Prior to A.02.00
Help Map ID:	3152

Select Marker

Specifies the selected marker. The term “selected marker” is used throughout this document to specify which marker is affected by the functions.

Key Path	Marker
Notes	The selected marker is remembered even when not in the Marker menu and is used if a Search is done or a Band Function is turned on or for Signal Track or Continuous Peak.
Preset	Marker 1

State Saved	The number of the selected marker is saved in instrument state.
Initial S/W Revision	Prior to A.02.00
Help Map ID	3153

Normal

Sets the control mode for the selected marker to **Normal** and turns on the active function for setting its value. If the selected marker was **Off**, it is placed at the center of the screen on the trace specified by the marker's Trace attribute.

A **Normal mode** (POSition type) marker can be moved to any point on the X-axis by specifying its X-axis value. Its absolute Y-axis value is then the value of the trace point at that X-axis value.

Key Path	Marker
Example	:CALC:MARK:MODE POS sets Marker 1 to Normal.
Notes	See the description under the "Marker" key, above.
Couplings	<ul style="list-style-type: none"> The marker addressed by this command becomes the selected marker on the front panel.
State Saved	The marker control mode (Normal, Delta, Fixed, Off) and X-axis value are saved in instrument state.
Initial S/W Revision	Prior to A.02.00
Help Map ID	3154

Delta

Sets the control mode for the selected marker to Delta and turns on the active function for setting its delta value. If the selected marker was **Off**, it is placed at the center of the screen on the trace specified by the marker's Trace attribute.

In Delta mode the marker result shows the relative result between the selected (Delta) marker and its reference marker. A delta marker can be moved to any point on the X-axis by specifying its X-axis offset from a reference marker. Its absolute Y-axis value is then the value of the trace point at that X-axis value.

Key Path	Marker
Example	:CALC:MARK:MODE DELT sets marker 1 to Delta.
Notes	See the description under the "Marker" key, above.
State Saved	The marker control mode (Normal, Delta, Fixed, Off) and X-axis value are saved in instrument state
Initial S/W Revision	Prior to A.02.00
Help Map ID	3155

Common Measurement Functions 1

Fixed

See “Fixed Marker X-axis Value” on page 1359.

See “Fixed Marker Y-axis Value” on page 1359.

Sets the control mode for the selected marker to Fixed. A fixed marker is fixed in the sense that it stays where you place it. It can be directly moved in both X and Y. It can be moved with a Peak Search. It can also be indirectly moved by re-zeroing the delta if it is a relative marker. If it is moved, it again becomes fixed at the X-axis point it moved to and it has a Y-axis result that it took on when it moved there. If a Normal or Delta marker is changed to Fixed it becomes fixed at the X-axis point it was at, and with the Y-axis result it had when it was set to Fixed.

In Fixed mode the marker result shows:

- If no Marker Function is on, the absolute X-axis and Y axis value of the marker
- If a Marker Function is on, the X-axis value and the Y-axis function result the marker had when it became fixed.

Fixed Marker X-axis Value

Key Path	Marker, Fixed
Example	:CALC:MARK:MODE FIX sets Marker 1 to Fixed.
Notes	See the description under the “Marker” key, above.
Dependencies	<p>You cannot directly set the X or Y value of a Fixed marker which has a marker function turned on. If an attempt is made to actually adjust it while a Marker Function is on, a message is generated. If the key is pressed, an advisory message is generated. If the equivalent SCPI command is sent, this same message is generated as part of a “-221, Settings conflict” warning.</p> <p>you cannot directly set the Y value of a Fixed marker while Normalize is turned on. If an attempt is made to do so while Normalize is on, a message is generated. If the key is pressed, an advisory message is generated. If the equivalent SCPI command is sent, this same message is generated as part of a “-221, Settings conflict” warning.</p>
State Saved	The marker control mode (Normal, Delta, Fixed, Off) and X and Y-axis values are saved in instrument state
Initial S/W Revision	Prior to A.02.00
Help Map ID	3489

Fixed Marker Y-axis Value

Key Path	Marker, Fixed
Example	:CALC:MARK:MODE FIX sets Marker 1 to Fixed.
Notes	See the description under the Marker key, above.
Dependencies	<p>you cannot directly set the X or Y value of a Fixed marker which has a marker function turned on. If an attempt is made to actually adjust it while a Marker Function is on, a message is generated. If the key is pressed, an advisory message is generated. If the equivalent SCPI command is sent, this same message is generated as part of a “-221, Settings conflict” warning.</p>
State Saved	The marker control mode (Normal, Delta, Fixed, Off) and X and Y-axis values are saved in instrument state
Default Unit	depends on the current selected Y axis unit
Initial S/W Revision	Prior to A.02.00
Help Map ID	3157

Off

Turns off the selected marker and its marker function setting, if any. However, Off does not affect which marker is selected.

Key Path	Marker
----------	---------------

Common Measurement Functions 1

Example	:CALC:MARK:MODE OFF sets Marker 1 to Off.
Notes	See the description under the “Marker” key, above.
State Saved	The marker control mode (Normal, Delta, Fixed, Off) is saved in instrument state
Initial S/W Revision	Prior to A.02.00
Help Map ID	3158

Properties

Opens a menu used to set certain properties of the selected marker.

Key Path	Marker
Initial S/W Revision	Prior to A.02.00
Help Map ID	3159

Select Marker

Duplicate of the **Select Marker** key under **Marker**. Selecting a marker here causes the same marker to be selected under **Marker**. (That is, there is only one “selected marker”.)

Relative To

Selects the marker that the selected marker is relative to (its reference marker).

Every marker has another marker to which it is relative. This marker is referred to as the “reference marker” for that marker. This attribute is set by the **Marker, Properties, Relative To** key. The marker must be a **Delta** marker to make this attribute relevant. If it is a **Delta** marker, the reference marker determines how the marker is controlled and how its value is displayed. A marker cannot be relative to itself.

Key Path	Marker, Properties
Remote Command	:CALCulate:MARKer [1] 2 3 4 5 6 7 8 9 10 11 12 :REFerence <integer> :CALCulate:MARKer [1] 2 3 4 5 6 7 8 9 10 11 12 :REFerence ?
Example	CALC:MARK1:REF 2 sets the marker 1 reference marker to 2 and turns marker 1 on as a delta marker.
Notes	A marker cannot be relative to itself so that choice is grayed out. If the grayed out key is pressed, an advisory message is generated. If the equivalent SCPI command is sent, this same message is generated as part of a “–221, Settings conflict” warning. See error –221.2200 in Master Error Messages: X-Series document for exact error text.

Notes	This command causes the marker specified with the subopcode to become selected. Range (for SCPI command): 1 to 12. If the range is exceeded the value is clipped.
Couplings	The act of specifying the selected marker's reference marker makes the selected marker a Delta marker. If the reference marker is off it is turned on in Fixed mode at the delta marker location.
Preset	The preset default "Relative To" marker (reference marker) is the next higher numbered marker (current marker +1). For example, if marker 2 is selected, then it's default reference marker is marker 3. The exception is marker 12, which has a default reference of marker 1. Set to the defaults by using Restore Mode Defaults . This is not reset by Marker Off , All Markers Off , or Preset .
State Saved	Saved in instrument state. Not affected by Marker Off and hence not affected by Preset or power cycle.
Min	1
Max	12
Status Bits/OPC dependencies	none Default (selected when Restore Mode Defaults is pressed): next higher numbered marker or 1 if marker 12.
Initial S/W Revision	Prior to A.02.00
Help Map ID	3160

X-axis scale (formerly Readout)

Accesses a menu that enables you to affect how the X-axis information for the selected marker is displayed in the marker area (top-right of display) and the active function area of the display, and how the marker is controlled. The available settings for the X-axis scale are Frequency, Period, Time, and Inverse Time.

See ["More Information" on page 1362](#).

Key Path	Marker, Properties
Remote Command	:CALCulate:MARKer [1] 2 3 4 5 6 7 8 9 10 11 12 :X:READout FREQUency TIME ITIME PERiod :CALCulate:MARKer [1] 2 3 4 5 6 7 8 9 10 11 12 :X:READout ? :CALCulate:MARKer [1] 2 3 4 5 6 7 8 9 10 11 12 :X:READout :AUTO ON OFF 1 0 :CALCulate:MARKer [1] 2 3 4 5 6 7 8 9 10 11 12 :X:READout :AUTO?
Example	CALC:MARK3:X:READ TIME sets the marker 3 X-axis scale to Time.

Common Measurement Functions 1

Notes	This command causes the specified marker to become selected.
Notes	This command causes the specified marker to become selected.
Preset	AUTO Marker Preset (selected when a marker is turned Off): Auto (see below). In most measurements the Auto settings results in Frequency being the preset readout.
State Saved	Saved in instrument state
Initial S/W Revision	Prior to A.02.00
Help Map ID	3161

More Information

The **X-axis scale** of a marker is the scale of its X-axis value. This affects the units displayed in the Marker Result block and used to specify the marker's X-axis location. The X-axis scale is specified using the **Marker, Properties, X-axis scale** key.

All markers in swept spans have both a time and frequency value. Which of these is used for the result display, and for positioning the marker, depends on the **X-axis scale** setting. The **X-axis scale** setting can be **Frequency** or **Time**, as well as the reciprocal of either (**Period** or **Inverse Time**). There is also an **Auto** setting - when in **Auto**, a marker's **X-axis scale** changes whenever the domain of the trace, upon which it set, changes. All choices for **X-axis scale** are allowed.

Auto

When in Auto, the X-Axis Scale is **Frequency** if the Marker Trace is a frequency domain trace, **Time** if the Marker Trace is a time domain trace. When in Auto, if the marker changes traces, or the domain of the trace the marker is on changes, the auto result is re-evaluated. If the X-axis scale is chosen manually, that Scale is used regardless of the domain of the trace.

Key Path	Marker, Properties, X-axis scale
Example	CALC:MARK2:X:READ:AUTO ON sets the marker 2 X-axis scaling to automatically select the most appropriate units.
Initial S/W Revision	Prior to A.02.00
Help Map ID	3066

Frequency

Sets the marker X-axis scale to Frequency, displaying the absolute frequency of a normal marker or the frequency of the delta marker relative to the reference marker. Frequency is the auto setting for frequency domain traces.

If Frequency is selected for a time domain trace, all of the points in the trace will show the same value. Attempting to use the knob or step keys to adjust the X-axis value of the marker or entering an X-axis value from the numeric keypad or remotely will have no effect but will generate no error.

Key Path	Marker, Properties, X-axis Scale
Example	CALC:MARK2:X:READ:FREQ sets the marker 2 X-axis scale to Frequency.

Notes	1-of-N readback is Frequency
State Saved	The X-axis scale setting is saved in instrument state.
Initial S/W Revision	Prior to A.02.00
Help Map ID	3162

Period

Sets the marker X-axis scale to Period, displaying the reciprocal of the frequency of the marker, or the reciprocal of the frequency separation of the two markers in a delta-marker mode. The units are those of time (sec, msec, et cetera). If the markers are at the same frequency in a delta marker mode, the result is the reciprocal of 0, which is infinitely large. The display will show “---” and a SCPI query will return infinity.

If Period is selected for a time domain trace, all of the points in the trace will show the same value. Attempting to use the knob or step keys to adjust the X-axis value of the marker or entering an X-axis value from the numeric keypad or remotely will have no effect but will generate no error.

Key Path	Marker, Properties, X-axis Scale
Example	CALC:MARK2:X:READ PER sets the marker 2 X-axis scale to Period.
Notes	1-of-N readback is Period
State Saved	The X-axis scale setting is saved in instrument state.
Initial S/W Revision	Prior to A.02.00
Help Map ID	3163

Time

Sets the marker X-axis scale to Time, displaying the time interval between a normal marker and the start of a sweep or the time of the delta marker relative to the reference marker. Time is the auto setting for time domain traces. In a delta-marker mode it is the (sweep) time interval between the two markers.

Key Path	Marker, Properties, X Axis Scale
Example	CALC:MARK2:X:READ TIME sets the marker 2 X-axis scale to Time.
Notes	1-of-N readback is Time
Couplings	Frequency domain traces taken in FFT mode have no valid time data. Therefore when Time is selected for markers on such traces, the X-axis value is taken as the appropriate percentage of the displayed sweep time, which is a calculated estimate.
State Saved	The X-axis scale setting is saved in instrument state
Initial S/W Revision	Prior to A.02.00
Help Map ID	3164

Inverse Time

Sets the marker X-axis scale to Inverse Time, displaying the reciprocal time. It is useful in a delta mode to show the reciprocal of (sweep) time between two markers. This function is only meaningful when on a time domain trace

Common Measurement Functions 1

and in the **Delta** control mode. If the markers are at the same X-axis value, the time between them is 0, so the reciprocal of sweep time is infinitely large. The display will show “---” and a SCPI query will return infinity.

Key Path	Marker, Properties, X Axis Scale
Example	:CALC:MARK2:X:READ ITIM sets the marker 2 X-axis scale to Inverse Time.
Notes	1-of-N readback is Inverse Time
Couplings	Frequency domain traces taken in FFT mode have no valid time data. Therefore when Inverse Time is selected for markers on such traces, the X-axis value is undefined, shows as “---” and returns not a number to a query.
State Saved	The X-axis scale setting is saved in instrument state
Initial S/W Revision	Prior to A.02.00
Help Map ID	3165

Marker Trace

Selects the trace that you want your marker to be placed on. A marker is associated with one and only one trace. This trace is used to determine the placement, result, and X-axis scale of the marker. All markers have an associated trace, even **Fixed** markers; it is from that trace that they determine their attributes and behaviors, and it is to that trace that they go when they become Normal or Delta markers.

See “[Auto Init On](#)” on page 1365.

See “[Auto Init Rules Flowchart](#)” on page 1365.

See “[Auto Init OFF](#)” on page 1365.

Key Path	Marker, Properties
Remote Command	:CALCulate:MARKer [1] 2 3 4 5 6 7 8 9 10 11 12 :TRACe 1 2 3 4 5 6 :CALCulate:MARKer [1] 2 3 4 5 6 7 8 9 10 11 12 :TRACe?
Example	CALC:MARK1:TRAC 2 places marker 1 on trace 2.
Notes	A marker may be placed on a blanked and/or inactive trace, even though the trace is not visible and/or updating. An application may register a trace name to be displayed on the key instead of a trace number.
Couplings	The state of Marker Trace is not affected by the Auto Couple key. If a Marker Trace is chosen manually, Auto Init goes to Off for that marker. Sending the remote command causes the addressed marker to become selected.
Preset	Presets on Preset or All Markers Off
State Saved	The Marker Trace and state of Auto Init for each marker is saved in instrument state.

Min	1
Max	6
Readback line	[TraceN, Auto Init] or [TraceN, Manual] where N is the trace number to which the marker is currently assigned.
Initial S/W Revision	Prior to A.02.00
Help Map ID	3166

Auto Init On

When **Auto Init** is true, the marker’s trace attribute is re-determined automatically by the test set whenever the marker turns on (Normal, Delta or Fixed) from an Off state. (The trace attribute is also determined for all markers that are on, whenever **Auto Init** is turned on).

When the marker moves between traces the marker’s X position in trace points is retained as it moves. For moving between active traces this generally means the x-axis value of the marker will not change. But for moving to or from an inactive trace, the x-axis value will take on that of the new trace at the bucket the marker was on the old trace (and is still on, on the new trace, since the bucket doesn’t change).

Note this is true even if the marker is off screen. Thus, a marker that is at the center of the screen on the old trace stays at the center of the screen on the new trace. A marker that is off screen one whole screen to the left on the old trace remains off screen one whole screen to the left on the new trace – even if this means it is at negative time.

Marker Trace is set to 1, and Auto Init is set to On, on a Preset or All Markers Off.

Auto Init Rules Flowchart

Auto Init OFF

This command associates the marker with the specified trace and turns Marker Trace, Auto Init OFF for that marker. If the marker is not **Off** it moves the marker from the trace it was on to the new trace. If the marker is **Off** it stays off but is now associated with the specified trace.

The query returns the number of the trace on which the marker is currently placed, even if that marker is in Auto mode.

Remote Command:	:CALCulate:MARKer [1] 2 3 4 5 6 7 8 9 10 11 12 :TRACe:AUTO OFF ON 0 1 :CALCulate:MARKer [1] 2 3 4 5 6 7 8 9 10 11 12 :TRACe:AUTO?
Notes:	Turning Marker Trace Auto Init off has no effect on the trace on which the marker is currently placed. The response to the query is 0 if OFF, 1 if ON.

Common Measurement Functions 1

Couplings:	The state of Auto Init is not affected by the Auto Couple key. Auto Init is set to True on a Preset or All Markers Off. If Auto Init is set to On for a marker and that marker is on, that marker's Marker Trace is immediately set according to the above flowchart. Sending the remote command causes the addressed marker to become selected.
Preset:	ON
Initial S/W Revision:	Prior to A.02.00
Help Map ID:	3167

Lines

When on, displays a vertical line of graticule height and a horizontal line of graticule width, intersecting at the indicator point of the marker (that is, the center of the X or the bottom tip of the diamond). The lines are blue in color.

If the marker is off screen the lines should be extended from the marker so that they go thru the screen area if possible. This is really useful for off screen Fixed markers as it lets you see their amplitude even though they are off the X-axis.

Key Path	Marker, Properties
Remote Command	:CALCulate:MARKer [1] 2 3 4 5 6 7 8 9 10 11 12 :LINes [:STATe] OFF ON 0 1 :CALCulate:MARKer [1] 2 3 4 5 6 7 8 9 10 11 12 :LINes [:STATe] ?
Example	:CALC:MARK2:LIN:ON turns Lines on for marker 2.
Couplings	Sending the remote command causes the addressed marker to become selected.
Preset	OFF
State Saved	Saved in State
Initial S/W Revision	Prior to A.02.00
Help Map ID	3168

Marker Table

When set to On the display is split into a measurement window and a marker data display window. For each marker which is on, information is displayed in the data display window, which includes the marker number, control mode, trace number, X axis scale, X axis value, and the Y-axis result. Additional information is shown for markers which have marker functions turned on.

Turning the Marker Table on turns the Peak Table off and vice versa.

Key Path	Marker
----------	--------

Remote Command	:CALCulate:MARKer:TABLE[:STATE] OFF ON 0 1 :CALCulate:MARKer:TABLE[:STATE]?
Example	CALC:MARK:TABL ON turns on the marker table.
Preset	OFF
State Saved	Whether the marker table is on is saved in instrument state
Initial S/W Revision	Prior to A.02.00
Help Map ID	3169

Marker Count

Accesses the marker count menu.

Key Path	Marker
Readback line	[On] if count on for the selected marker, [Off] if it is off.
Initial S/W Revision	Prior to A.02.00
Help Map ID	3170

Counter On/Off

Turns the marker frequency counter on and off. The selected marker is counted, and if the selected marker is a delta marker and its reference marker is not fixed, the reference marker is counted as well.

See [“Understanding the Marker Counter” on page 1369](#).

See [“Query Count Value” on page 1368](#).

Key Path	Marker Function, Marker Count
Remote Command	:CALCulate:MARKer[1] 2 3 4 5 6 7 8 9 10 11 12:FCOunt[:S TATe] OFF ON 0 1 :CALCulate:MARKer[1] 2 3 4 5 6 7 8 9 10 11 12:FCOunt[:S TATe]?
Example	CALC:MARK2:FCO ON selects marker 2, turns it on, and turns on the counter CALC:MARK2:FCO:X? returns the counted frequency.

Common Measurement Functions 1

Notes	<p>Fixed markers are not counted, but a Fixed marker will have a count stored in it if it is selected or is the reference marker for the selected marker. The count already in the marker is stored when the marker becomes fixed and if there is none or the marker moves (for example, Pk Search) it is counted and stored after the next sweep.</p> <p>If a Fixed marker has a count stored in it, that count is displayed when the marker is selected, and used as the reference count when that marker is a reference marker.</p> <p>If a Fixed marker has a count stored in it, that count is deleted if the marker X is adjusted.</p> <p>If a Fixed marker has a count stored in it, and a Search function is performed using the Fixed marker, while the counter is on, the count stored in the marker is updated.</p> <p>If a Fixed marker has a count stored in it, and is a reference marker, and the reference is moved to a valid trace point by re-zeroing the delta (by pressing Delta again or sending the DELTa SCPI command), while the counter is on, the count stored in the marker is updated.</p>
Notes	This command causes the specified marker to become selected.
Dependencies	Marker Count is unavailable (grayed out and Off) if the Gate function is on.
Couplings	<p>If the selected marker is Off when the counter is turned on, the selected marker is set to Normal and placed at center of screen on the trace determined by the Marker Trace rules.</p> <p>If a marker which is OFF is selected while the counter is on, the counter remains on, but since the marker is off, the count is undefined. In this case, the test set returns "not a number" to a SCPI count query.</p> <p>The counter is turned OFF when the selected marker is turned OFF.</p>
Preset	OFF
State Saved	The state of the counter (on/off) is saved in instrument state. In the case of Fixed markers, the count stored in the marker is saved in instrument state.
Initial S/W Revision	Prior to A.02.00
Help Map ID	3171

Query Count Value

Queries the frequency count. The query returns the absolute count unless the specified marker is in Delta mode, then it returns the relative count. If the marker is off, or the marker is on but the counter is off, the test set will return "not a number" to a SCPI count query. A marker with no stored count, or a non-**Fixed** marker on a stored trace, will also return not a number to a SCPI count query. Note this result may simply mean that the first sweep after the counter turned on has not yet completed.

Remote Command:	:CALCulate:MARKer [1] 2 3 4 5 6 7 8 9 10 11 12 :FCOUNT :X?
Notes:	This query does NOT cause the specified marker to become selected.
Initial S/W Revision:	Prior to A.02.00

Help Map ID:

0

Understanding the Marker Counter

See [“Counting Off-screen Markers” on page 1369](#).

See [“Delta Marker” on page 1369](#).

See [“Fixed Markers” on page 1369](#).

See [“More Information on "Counter"” on page 1370](#).

Using the internal counter we can count the frequency of a marker, but we cannot count while we are actually sweeping. So, once we are done with a sweep, we move to the selected marker frequency and count that frequency. Then, if the marker is a Delta marker, the count is also taken for its reference marker. The count is actually performed by moving the LO to the frequency (or frequencies in the case of a delta marker) we wish to count. The count is executed on a marker by marker basis and no further count is taken until after the next sweep (even if the marker moves before another sweep has completed).

The Marker Count is taken by tuning the test set to the frequency of the marker and counting the IF, with the test set not sweeping. The count is adjusted for display by adding or subtracting it (as appropriate) from the LO frequency, so that you see a count that represents the signal frequency. This is true even if External Mixing is on. Since all this happens between sweeps, you never see the test set retuning to do the counts.

If you wish to see the entered frequency of a counted marker it will appear in the active function area when that marker is selected (for Fixed markers, you have to press the Marker, Fixed key to select Fixed markers and then press it a second time to view or adjust the x or y marker values).

Counting Off-screen Markers

If the selected marker is off the X-axis the test set can still be tuned to the marker (unless it is outside the range of the test set), so the count can still be displayed. This means you can see a count for an off-screen marker even though there may be no valid Y-value for the marker. If the marker frequency is outside the range of the test set, the display will show three dashes in the count block (---), and not a number is returned to a SCPI count query.

Delta Marker

When a Delta Marker is selected while Marker Count is on:

If the reference marker is not a fixed marker, the display shows the difference between the count of the selected marker and the count of the reference marker

If the reference marker is a fixed marker and there is a count stored in the marker (because Marker Count was on when the marker became a fixed marker), the display shows the difference between the count at the marker and the count stored in the reference marker.

Marker Count works in zero span as well as in Swept analysis. The test set tunes to the frequency of the selected marker, which, for active zero span traces, is simply the center frequency of the test set.

Fixed Markers

Fixed markers have a count stored in them that is generally kept fixed and not updated. If a fixed marker

Common Measurement Functions 1

is selected, or used as a reference, the signal at the marker frequency is not counted; rather the stored count is seen or used as the reference. The count is stored, if Count is on, when the marker becomes fixed or when, while fixed, the marker is moved by re-zeroing the reference (if it is the reference marker) or via a peak search (since both of these, by definition, use valid trace data). The count stored in a Fixed marker is lost if the counter is turned off, if the marker is moved to an inactive trace, or if the marker is moved by adjusting its x-value.

More Information on "Counter"

When the counter is on, the count (or the delta count) for the selected marker is displayed.

The invalid data indicator (*) will turn on until the completion of the first count.

Marker Count frequency readings are corrected using the **Freq Offset** function. Note however that Marker Delta readings are not corrected, as any offset would be applied to both.

In zero span on active traces the counter continues to function, counting any signal near the center frequency of the test set.

NOTE No signal farther from the marker frequency than the Res BW is seen by the counter.

The above command turns on or off the frequency counter. If the specified marker number in the command is not the selected marker, it becomes the selected marker. If the specified marker number is not on, FCount ON sets it to Normal and places it at center of screen on the trace determined by the Marker Trace rules. Once the marker count is on, it is on for any selected marker, not just for the one used in the command. A 1 is returned to the state query only if marker count is on and the specified number is the selected marker. The invalid data indicator (*) will turn on until the completion of the first count but this does not keep a value from being returned.

Gate Time Auto/Man

Controls the length of time during which the frequency counter measures the signal frequency. Longer gate times allow for greater averaging of signals whose frequency is “noisy”, though the measurement takes longer. If the gate time is an integer multiple of the length of a power-line cycle (20 ms for 50 Hz power, 16.67 ms for 60 Hz power), the counter rejects incidental modulation at the power line rate. The shortest gate time that rejects both 50 and 60 Hz modulation is 100 ms, which is the value chosen in Auto, or on Preset or when Auto Couple is pressed.

The start time of the Gate Time of the counter must be controlled by the same trigger parameters as controls the sweep. Thus, if the Trigger is not in Free Run, the counter gate must not start until after the trigger is received and delayed.

Key Path	Marker Function, Marker Count
----------	-------------------------------

Remote Command	<pre>:CALCulate:MARKer [1] 2 3 4 5 6 7 8 9 10 11 12 :FCOunt :GATetime <time></pre> <pre>:CALCulate:MARKer [1] 2 3 4 5 6 7 8 9 10 11 12 :FCOunt :GATetime?</pre> <pre>:CALCulate:MARKer [1] 2 3 4 5 6 7 8 9 10 11 12 :FCOunt :GATetime:AUTO OFF ON 0 1</pre> <pre>:CALCulate:MARKer [1] 2 3 4 5 6 7 8 9 10 11 12 :FCOunt :GATetime:AUTO?</pre>
Example	:CALC:MARK2:FCO:GAT 1e-2 sets the gate time for Marker 2 to 10 ⁽⁻²⁾ s = 10 ms.
Notes	When Auto Couple is pressed, Gate Time is set to 100 ms.
Notes	This command causes the specified marker to become selected.
Preset	100 ms ON
State Saved	Saved in instrument state.
Min	1 us
Max	500 ms
Initial S/W Revision	Prior to A.02.00
Help Map ID	3173

Couple Markers

When this function is true, moving any marker causes an equal X-axis movement of every other marker which is not Fixed or Off. By “equal X-axis movement” we mean that we preserve the difference between each marker’s X-axis value (in the fundamental x-axis units of the trace that marker is on) and the X-axis value of the marker being moved (in the same fundamental x-axis units).

Note that Fixed markers do not couple. They stay where they were while all the other markers move. Of course, if a Fixed marker is being moved, all the non-fixed markers do move with it.

This may result in markers going off screen.

Key Path	Marker
Remote Command	<pre>:CALCulate:MARKer:COUPle [:STATe] OFF ON 0 1</pre> <pre>:CALCulate:MARKer:COUPle [:STATe] ?</pre>
Example	:CALC:MARK:COUP ON sets Couple Markers on.
Preset	Off, presets on Mode Preset and All Markers Off
State Saved	Saved in State
Initial S/W Revision	Prior to A.02.00
Help Map ID	3174

Common Measurement Functions 1

All Markers Off

Turns off all markers. See Marker, “Off” on page 1359.

Key Path	Marker
Remote Command	:CALCulate:MARKer:AOff
Example	CALC:MARK:AOff turns off all markers.
Couplings	sets the selected marker to 1.
Preset	n/a.
Initial S/W Revision	Prior to A.02.00
Help Map ID	3175

Marker Function

The Marker Function key opens up a menu of softkeys that allow you to control the Marker Functions of the instrument. Marker Functions perform post-processing operations on marker data. Band Functions are Marker Functions that allow you to define a band of frequencies around the marker. The band defines the region of data used for the numerical calculations. These marker functions also allow you to perform mathematical calculations on trace and marker data and report the results of these calculations in place of the normal marker result.

NOTE Unlike regular markers, marker function markers are not placed directly on the trace. They are placed at a location which is relative to the result of the function calculation.

See “More Information” on page 1373.

See “Fixed marker functions” on page 1373.

See “Interval Markers” on page 1374.

Remote Command	:CALCulate:MARKer[1 2 3 4 5 6 7 8 9 10 11 12:FUNCTION NOISE BPOWer BDENsity OFF :CALCulate:MARKer[1 2 3 4 5 6 7 8 9 10 11 12:FUNCTION?
Notes	Sending this command selects the subopcoded marker The marker function result is queried in the same fashion as the Marker Result, as outlined in the Marker section, with the CALC:MARK:Y? command.

Dependencies	Fixed markers: It is not possible to change the Band Function for a Fixed marker; so all of the Band Function keys are grayed out for a Fixed marker. If a marker function was already on when the marker became Fixed then the selected Band Function is shown but cannot be changed. Therefore, you cannot directly set the X or Y value of a Fixed marker which has a marker function turned on. To turn off the function, turn off the marker.
Preset	OFF
State Saved	The band function for each marker is saved in Instrument State
Initial S/W Revision	Prior to A.02.00
Help Map ID	3180

More Information

The units to be used for displaying Marker Function results in Delta mode vary depending on what is the reference marker and what it is referenced to.

Marker Functions are different from Measurements, which automatically perform complex sequences of setup, data acquisition, and display operations in order to measure specified signal characteristics. Marker Functions are specified for each individual marker and may be turned on individually for each marker.

The **Marker Fctn** menu controls which marker functions are turned on and allows you to adjust setup parameters for each function. The Marker Functions are **Marker Noise**, **Band/Interval Power**, and **Band/Interval Density**, only one of which can be on for a given marker.

If the selected marker is off, pressing Marker Fctn sets it to Normal and places it at the center of the display on the trace determined by the Marker Trace rules. However, if the selected marker was **Off**, **Marker Function Off** had to be the selected function, and it remains so even after the marker is thus turned on, although you may then change it.

Fixed marker functions

In the case of a fixed marker, it is not possible to turn on or change a band function. This is because a Fixed marker holds the value it had when it became fixed; the trace it was on may keep on changing, so the function value, which depends on trace data, could not be calculated on an ongoing basis.

It is possible to have a Marker Function on for a Fixed marker, in the case where a function was already on when the marker became Fixed. In this case the function value will be retained in the marker. It is also possible to have a Marker Function on for a Fixed marker in the case when the marker was off and was turned on as **Fixed** because **Delta** was pressed to create a reference marker - in which case the marker function, marker function width, Y Axis value and marker function result that the **Delta** marker had when **Delta** was pressed are copied into the Fixed marker. If **Delta** is pressed again, causing the fixed reference marker to move to the delta marker's position, the marker function, marker function width, Y Axis value and marker function result that the **Delta** marker had when **Delta** was pressed are again copied into the fixed reference marker.

If a Marker Function is on for a Fixed marker, the marker's reported value is derived by the function. Therefore you cannot directly set the X or Y value of a Fixed marker which has a marker function turned

Common Measurement Functions 1

on. Indirect setting as detailed above or when a Peak Search is performed is allowed, as the Fixed marker is always placed on a trace and can derive its function value from the trace at the moment when it is placed.

Interval Markers

What is an interval marker? The band power marker computes the total power within a span in a nonzero span. The results computation must include the RBW. The interval power marker measures the average power across some time interval in zero span.

Interval Density is defined to be Interval Power divided by Bn. Bn is the noise bandwidth of the RBW filter, as noted and used within the Band Power computation.

Select Marker

See [“Select Marker” on page 1356](#).

Marker Noise

Turns on the Marker Noise function for the selected marker, making it a noise marker. If the selected marker is off, it is turned on in **Normal** mode and located at the center of the screen.

When **Marker Noise** is selected while in the **Marker Function Off** state, the **Band Span** or **Interval Span** is initialized to 5% of the screen width.

When **Marker Noise** is on, the marker’s Y Axis Result is the average noise level, normalized to a 1 Hz noise power bandwidth, in the band specified under the **Band Adjust** key.

See [“More Information” on page 1375](#).

See [“Off-trace Markers” on page 1375](#).

Key Path	Marker Function
Example	<p>CALC:MARK:FUNC NOIS turns on marker 1 as a noise marker.</p> <p>CALC:MARK:FUNC? returns the current marker function for the marker specified. In this case it returns the string: NOIS.</p> <p>CALC:MARK:Y? returns the y-axis value of the Marker Noise function for marker 1 (if Marker Noise is ON for marker 1). Note that the delta value when the Y axis unit is Watt is the square of the delta value when the Y axis unit is Volt. For example, when the percent ratio with Y axis unit in Volt is 0.2, the percent ratio with Y axis unit in Watt will be $0.2^2 = 0.04$. When you read the value out remotely you have to know whether your Y Axis Unit is log (dB), linear (V or A), or power (W).</p>
Notes	See the description under the ““Marker Function” on page 1372” key.
Dependencies	Fixed markers: It is not possible to change the Band Function for a Fixed marker; so all of the Band Function keys are grayed out for a Fixed marker.
Couplings	Average detector and Power Averaging auto selected when Marker Noise on If the selected (specified) marker is off, selecting Marker Noise via front panel or SCPI will turn the marker on.

Initial S/W Revision	Prior to A.02.00
Help Map ID	3181

More Information

To guarantee accurate data for noise-like signals, a correction for equivalent noise bandwidth is made by the analyzer. The **Marker Noise** function accuracy is best when the detector is set to Average or Sample, because neither of these detectors will peak-bias the noise. The trade off between sweep time and variance of the result is best when Average Type is set to Power Averaging. Therefore, Auto coupling chooses the Average detector and Power Averaging when Marker Noise is on. Though the Marker Noise function works with all settings of detector and Average Type, using the positive or negative peak detector gives less accurate measurement results.

Off-trace Markers

If a **Normal** or **Delta** noise marker is so near to the left or right edge of the trace that some of the band is off the trace, then it uses only that subset of the Band Width that is on-trace. If the marker itself is off-trace, its value becomes undefined.

Neither band/interval power nor band/interval density markers are defined if any part of the band is off-trace (unless they are Fixed with a stored function value in them), except that when the edges of the bandwidth are trivially off-screen, due to mathematical limitations in the analyzer or in the controlling computer, the result will still be considered valid.

Band/Interval Power

Turns on the Band/Interval Power function for the selected marker. If the selected marker is off it is turned on in **Normal** marker and located at the center of the screen.

When **Band/Interval Power** is selected while in the **Marker Function Off** state, the **Band Span** or **Interval Span** is initialized to 5% of the screen width.

If the detector mode for the detector on the marker's trace is set to Auto, the average detector is selected. If the Average type is set to Auto, Power Averaging is selected. Other choices for the detector or Average type will usually cause measurement inaccuracy.

Key Path	Marker Function
Example	<p>CALC:MARK:FUNC BPOW turns on marker 1 as a band power marker.</p> <p>CALC:MARK2:FUNC? returns the current setting of marker function for marker 2. In this case it returns the string: BPOW.</p> <p>CALC:MARK:Y? returns the y-axis value of the Band Power function for marker 1. Note that the delta value when the Y axis unit is Watt is the square of the delta value when the Y axis unit is Volt. For example, when the percent ratio with Y axis unit in Volt is 0.2, the percent ratio with Y axis unit in Watt will be $0.2^2 = 0.04$. When you read the value out remotely you have to know whether your Y Axis Unit is log (dB), linear (V or A), or power (W).</p>
Notes	See the description under the ““Marker Function” on page 1372” key, above.

Common Measurement Functions 1

Dependencies	Fixed markers: It is not possible to change the Band Function for a Fixed marker; so all of the Band Function keys are grayed out for a Fixed marker.
Couplings	If the detector mode for the detector on the marker's trace is set to Auto, the average detector is selected. If the Average type is set to Auto, Power Averaging is selected. If the selected (specified) marker is off, selecting Band Power via front panel or SCPI will turn the marker on.
Initial S/W Revision	Prior to A.02.00
Help Map ID	3182

Band/Interval Density

Turns on the Band/Interval Density function for the selected marker. If the selected marker is off it is turned on in **Normal** marker mode and located at the center of the screen.

When **Band/Interval Density** is selected while in the **Marker Function Off** state, the **Band Span** or **Interval Span** is initialized to 5% of the screen width.

See [“More Information” on page 1377](#).

See [“What is band/interval density?” on page 1377](#)

Key Path	Marker Function
Example	CALC:MARK:FUNC BDEN turns on marker 1 as a band density marker. CALC:MARK:FUNC? returns the current setting of band function for the marker specified. In this case it returns the string: BDEN. CALC:MARK:Y? returns the y-axis value of the Band Density function for marker 1. Note that the delta value when the Y axis unit is Watt is the square of the delta value when the Y axis unit is Volt. For example, when the percent ratio with Y axis unit in Volt is 0.2, the percent ratio with Y axis unit in Watt will be $0.2^2 = 0.04$. When you read the value out remotely you have to know whether your Y Axis Unit is log (dB), linear (V or A), or power (W).
Notes	The zero-width case is treated as one bucket wide although it shows a width of 0. When the trace the marker is on crosses domains, the width crosses domains as well, to remain the same percentage of the trace
Notes	See the description under the “Marker Function” on page 1372 key, above.
Dependencies	Fixed markers: It is not possible to change the Band Function for a Fixed marker; so all of the Band Function keys are grayed out for a Fixed marker.
Couplings	If the detector mode for the detector on the marker's trace is set to Auto, the average detector is selected. If the Average type is set to Auto, Power Averaging is selected. If the selected (specified) marker is off, selecting Band Density via front panel or SCPI will turn the marker on.

State Saved	n/a.
Initial S/W Revision	Prior to A.02.00
Help Map ID	3183

More Information

It may seem like the band density marker function is exactly like a function of a noise marker with variable width. But they are somewhat different. The Noise markers assume that the signal to be measured is noise-like. Based on this assumption, we can actually make reasonable measurements under very nonideal conditions: any detector may be used, any averaging type, any VBW. In contrast, the Band Power and Band Density markers make no assumption about the statistics of the signal.

If the detector mode for the detector on the marker’s trace is set to Auto, the average detector is selected. If the Average type is set to Auto, Power Averaging is selected. Other choices for the detector or Average type will usually cause measurement inaccuracy.

What is band/interval density?

On frequency domain traces, the average density across a band is the total band power divided by the bandwidth over which it is measured.

On time domain traces, interval density is the average power in the interval divided by the noise bandwidth of the RBW of the trace.

Marker Function Off

Turns off band functions for the selected marker.

Key Path	Marker Function
Example	:CALC:MARK:FUNC OFF turns off marker functions for marker 1
Notes	See the description under the “Marker” on page 1353 key, above.
Dependencies	Fixed markers: It is not possible to change the Band Function for a Fixed marker; so all of the Band Function keys are grayed out for a Fixed marker, including Off
Couplings	Turning off the marker function has no effect on the band span nor does it turn the marker off.
Initial S/W Revision	Prior to A.02.00
Help Map ID	3184

Band Adjust

Opens a menu that lets you set the width or left or right edges of the band.

It is legal to change the width of the band even if there is no marker function on. Generally this can only happen by sending the SCPI command since access to the menu is restricted if no marker function is on.

Key Path	Marker Function
----------	------------------------

Common Measurement Functions 1

Dependencies	If the marker is Fixed, Band Adjust is grayed out. If the marker function is Off, Band Adjust is grayed out.
Couplings	If any of the Band Adjust functions are the active function, the wings and arms of the selected marker display in green; otherwise they display in white.
Initial S/W Revision	Prior to A.02.00
Help Map ID	3185

Band/Interval Span

Sets the width of the span for the selected marker.

It is legal to change the width of the band even if there is no marker function on. Generally this can only happen by sending the SCPI command since access to the menu is restricted if no marker function is on.

In the table below, $\text{sweep_width} = \max(1, \text{sweep_points} - 1)$ and sweep_points is the number of sweep points, set in the **Sweep** menu.

Key Path	Marker Function, Band Adjust
Remote Command	:CALCulate:MARKer [1] 2 3 4 5 6 7 8 9 10 11 12 :FUNCtion: BAND:SPAN <freq> :CALCulate:MARKer [1] 2 3 4 5 6 7 8 9 10 11 12 :FUNCtion: BAND:SPAN?
Example	:CALC:MARK12:FUNC:BAND:SPAN 20 MHz sets the band span of marker 12 to 20 MHz :CALC:MARK:FUNC:BAND:SPAN? queries the band span of Marker 1
Notes	Units are those of the trace's domain, Hz for frequency domain, s for time domain.
Notes	Sending this command selects the subopcoded marker The unit of the parameter must match the current domain of the trace the selected marker is on, or an invalid suffix error will be generated. If no unit is sent the fundamental unit for the trace domain will be used (Hz for freq domain traces, s for time domain traces). Note that all the values provided in this table are only valid for frequency domain traces. If the current domain of the trace is time domain, values and unit will be different. In frequency domain, the Preset value is dependant on the frequency range of the instrument. The default value 1.3245 GHz is appropriate only if the instrument is a 26.5 GHz instrument (Option 526). In a 26.5 GHz Instrument, the default span is 26.49 GHz, so 5% of the span corresponds to 1.3245 GHz.
Couplings	Changing the Band/Interval Span necessarily changes the Band/Interval Left and Band/Interval Right values Band/Interval Span is set to 0 when the marker is turned off Band/Interval Span is set to 5% of span when any marker function is turned on if and only if it is zero at that time

Preset	If 0, set to 5% of span, when a marker function is turned on
State Saved	Saved in Instrument State
Min	0 Hz
Max	Infinity. Unlike legacy analyzers, where the markers were forced to be on screen, X-Series marker values are not limited and do not clip
Backwards Compatibility SCPI	:CALCulate:MARKer[1] 2 3 4:X:SPAN
Initial S/W Revision	Prior to A.02.00
Help Map ID	3186

Band/Interval Left

Sets the left edge frequency or time for the band of the selected marker. The right edge is unaffected.

It is legal to change the width of the band even if there is no marker function on. Generally this can only happen by sending the SCPI command since access to the menu is restricted if no marker function is on.

In the table below, sweep_width = max(1,sweep_points-1) and sweep_points is the number of sweep points, set in the **Sweep** menu.

Key Path	Marker Function, Band Adjust
Remote Command	:CALCulate:MARKer [1] 2 3 4 5 6 7 8 9 10 11 12 :FUNction: BAND:LEFT <freq> :CALCulate:MARKer [1] 2 3 4 5 6 7 8 9 10 11 12 :FUNction: BAND:LEFT?
Example	:CALC:MARK12:FUNC:BAND:LEFT 20 GHz sets the left edge of the band span of marker 12 to 20 GHz :CALC:MARK:FUNC:BAND:LEFT? queries the band span of Marker 1
Notes	Units are those of the trace’s domain, Hz for frequency domain, s for time domain. When the left edge is moved, the right edge stays anchored; thus, the marker’s frequency will change.
Notes	Sending this command selects the subopcoded marker The unit of the parameter must match the current domain of the trace the selected marker is on, or an invalid suffix error will be generated.If no unit is sent the fundamental unit for the trace domain will be used (Hz for freq domain traces, s for time domain traces). Note that all the values provided in this table are only valid for frequency domain traces. If the current domain of the trace is time domain, values and unit will be different. In frequency domain, the Preset value is dependant on the frequency range of the instrument. The default value 1.3245 GHz is appropriate only if the instrument is a 26.5 GHz instrument (Option 526). In a 26.5 GHz Instrument, the default span is 26.49 GHz, so 5% of the span corresponds to 1.3245 GHz.

Common Measurement Functions 1

Couplings	<p>Changing the Band/Interval Left necessarily changes the Band/Interval Span and Band/Interval Center values</p> <p>Band/Interval Span is set to 0 when the marker is turned off so that means Band/Interval Left is set to the center value at this time</p> <p>Band/Interval Span is set to 5% of span when any marker function is turned on if and only if it is zero at that time</p>
Preset	If 0, Band/Interval Span is set to 5% of span, when a marker function is turned on, which affects Band/Interval Left
State Saved	Saved in Instrument State
Min	0 Hz
Max	Infinity. Unlike legacy analyzers, where the markers were forced to be on screen, X-Series marker values are not limited and do not clip
Backwards Compatibility SCPI	:CALCulate:MARKer[1] 2 3 4:X:STARt (This legacy command was used to control the Reference marker in Delta Pair/Band Pair mode, and is aliased to the new command.)
Initial S/W Revision	Prior to A.02.00
Help Map ID	3188

Band/Interval Right

Sets the right edge frequency or time for the band of the selected marker. The left edge is unaffected

In the table below, $\text{sweep_width} = \max(1, \text{sweep_points} - 1)$ and sweep_points is the number of sweep points, set in the **Sweep** menu.

It is legal to change the width of the band even if there is no marker function on. Generally this can only happen by sending the SCPI command since access to the menu is restricted if no marker function is on.

Key Path	Marker Function, Band Adjust
Remote Command	:CALCulate:MARKer[1] 2 3 4 5 6 7 8 9 10 11 12:FUNction: BAND:RIGHT <freq> :CALCulate:MARKer[1] 2 3 4 5 6 7 8 9 10 11 12:FUNction: BAND:RIGHT?
Example	:CALC:MARK12:FUNC:BAND:RIGHT 20 GHz sets the right edge of the band span of marker 12 to 20 GHz :CALC:MARK:FUNC:BAND:RIGHT? queries the band span of Marker 1
Notes	Units are those of the trace's domain, Hz for frequency domain, s for time domain. When the right edge is moved, the left edge stays anchored; thus, the marker's frequency will change.

Notes	<p>Sending this command selects the subopcoded marker</p> <p>The unit of the parameter must match the current domain of the trace the selected marker is on, or an invalid suffix error will be generated. If no unit is sent the fundamental unit for the trace domain will be used (Hz for freq domain traces, s for time domain traces).</p> <p>Note that all the values provided in this table are only valid for frequency domain traces. If the current domain of the trace is time domain, values and unit will be different. In frequency domain, the Preset value is dependant on the frequency range of the instrument. The default value 1.3245 GHz is appropriate only if the instrument is a 26.5 GHz instrument (Option 526). In a 26.5 GHz Instrument, the default span is 26.49 GHz, so 5% of the span corresponds to 1.3245 GHz.</p>
Couplings	<p>Changing the Band/Interval Right necessarily changes the Band/Interval Span and Band/Interval Center values</p> <p>Band/Interval Span is set to 5% of span when any marker function is turned on if and only if it is zero at that time</p>
Preset	If 0, Band/Interval Span is set to 5% of span, when a marker function is turned on, which affects Band/Interval Right
State Saved	Saved in Instrument State
Min	0 Hz
Max	Infinity. Unlike legacy analyzers, where the markers were forced to be on screen, X-Series marker values are not limited and do not clip
Backwards Compatibility SCPI	<p>:CALCulate:MARKer[1] 2 3 4:X:STOP</p> <p>(This legacy command was used to control the Delta marker in Delta Pair/Band Pair mode, and is aliased to the new command. For compatibility. Note that if you were using the old command for Band Power measurements it will work just fine.)</p>
Initial S/W Revision	Prior to A.02.00
Help Map ID	3190

Measure at Marker

This key and all the keys in this menu only appear with the N6141A or W6141A application or Option EMC installed and licensed.

Key Path	Marker Function
Dependencies	The Measure at Marker menu is not available in Spectrogram.
Initial S/W Revision	A.02.00
Help Map ID	3816

Measure at Marker

When this key is pressed, the analyzer executes one Measure at Marker function and then returns.

Common Measurement Functions 1

Measure at Marker goes to the frequency of the selected marker and takes a reading with each of the three detectors selected in the Detectors menu, using the dwell times specified there, then displays the readings in a window on the display, using the current Y-Axis Unit.

When the Measure at Marker is complete, the analyzer restores all settings to their pre-Measure-at-Marker values and normal sweeps resume.

Key Path	Marker Function, Measure at Marker
Remote Command	:CALCulate:MARKer [1] 2 3 4 5 6 7 8 9 10 11 12 :FUNction: MAMarker?
Example	:CALC:MARK2:FUNC:MAM? Performs a Measure at Marker function at Marker 2's current frequency and, when completed, returns the results of the measure at marker window in a query
Notes	<p>This query command returns comma separated values for the 3 specified detectors and the frequency value of the marker. If a Detector is off or if no measurement has yet completed, -999.0 will be returned. This can happen, for example, if you are operating with too large a value of (span/sweep points) and the Measure at Marker function does not execute but instead puts up the advisory message, "Span per point too large, narrow span or increase RBW or number of points" (see below).</p> <p>The size of the return data array is fixed at 4. The elements are:</p> <ol style="list-style-type: none"> 1. Detector 1 value (if off, -999.0 for backwards compatibility) 2. Detector 2 value (if off, -999.0 for backwards compatibility) 3. Detector 3 value (if off, -999.0 for backwards compatibility) 4. Frequency of Marker <p>If a sweep is in process when this function executes it aborts, and restarts after the function is complete.</p> <p>This command is not backwards compatible with the E7400 and PSA option 239 so the Backwards Compatibility command is included.</p>
Dependencies	If BW & Avg Type is in Autocoupled state, the (up to three) measurements taken by Measure at Marker are taken with Auto Coupled settings for the functions in the BW menu, even if those functions are in manual.
Couplings	If the specified Marker is not on, the analyzer turns it on at center of screen and does a peak search before performing the function.
Status Bits/OPC dependencies	OPC goes true when the measurement is complete
Backwards Compatibility SCPI	:MEASure:EMI:MARKer[1] 2 3 4 5 6 7 8 9 10 11 12? (Performs a Measure at Marker function at specified marker's current frequency and returns the results)
Initial S/W Revision	A.02.00
Help Map ID	3817

Measure at Marker presents its information in a separate window which normally appears in the upper right of the display but can be repositioned to the upper left.

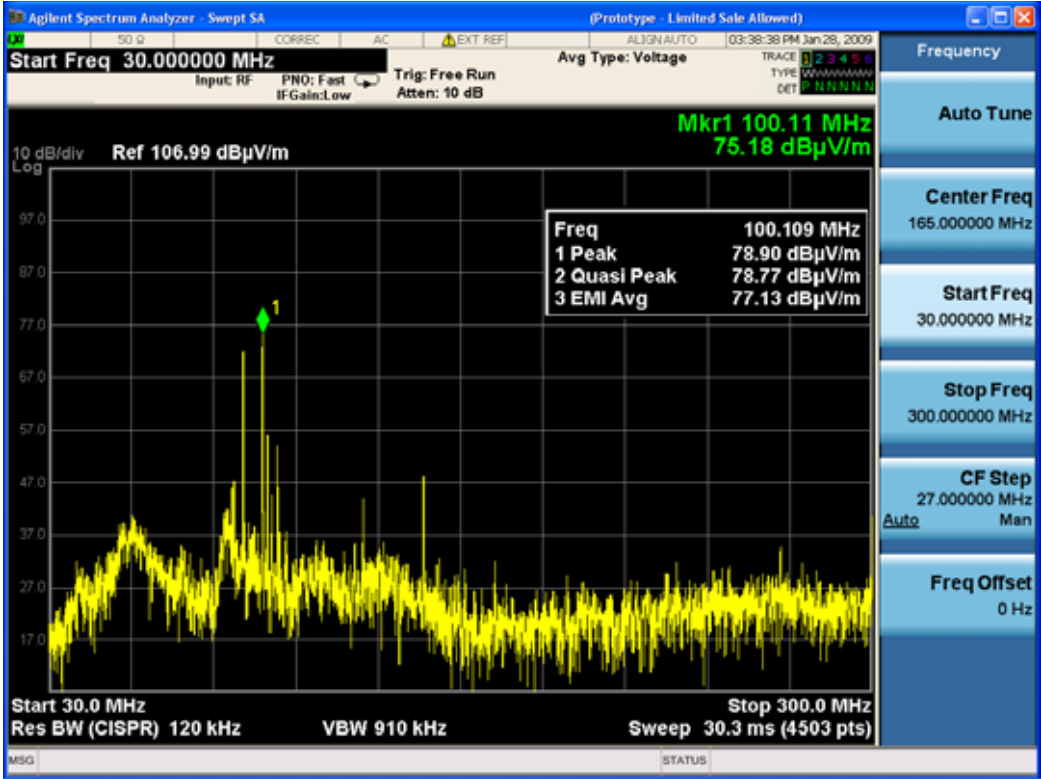

The Measure at Marker box shows the detector name for the selected detectors and “Off” for those not selected. The names used are:

Name	Detector
Normal	Normal
Peak	Peak
Sample	Sample
Neg Peak	Negative Peak
RMS	Average detector with Power Average (RMS)
Log Avg	Average detector with Log-Pwr Average
VoltageAvg	Average detector with Voltage Average
Quasi Peak	Quasi Peak
EMI Avg	EMI Average
RMS Avg	RMS Average

The marker frequency is shown in the “Freq” field. The measured value is shown for all detectors except those that are “Off.” For these, --- is displayed. The current Y-Axis unit is used, and the precision that is

Common Measurement Functions 1

used for the detector value displays is exactly the same as for the Marker The precision used for the Frequency display is six significant digits.

The sequence of steps in the measurement is as follows:

- Any sweep in progress is aborted.
- If in Zero Span, the Center Frequency is used as the frequency at which to take the reading, since in Zero Span, all markers are by definition at the Center Frequency
- If not in Zero Span:
 - If the selected marker is Off, it is first turned on in the center of the screen and a peak search performed.
 - If the selected marker is on, but offscreen, it is first moved to the center of the screen and a peak search performed.
 - A frequency “zoom” function is performed to determine the frequency of the selected marker to the required precision. If you are operating with too large a value of (span/sweep points) then the Measure at Marker window will not display, but instead an advisory message, “Span per point too large, narrow span or increase RBW or number of points”. This means you have chosen a combination of RBW, span and sweep points that makes each trace point much wider than the RBW, so that the trace point in which the signal appears is an inadequately precise measure of its frequency—for example, with a 30 MHz to 1000 MHz span, 601 trace points and 120 kHz RBW, each trace point is 13 times as wide as the RBW. In this case, a SCPI query of the results will yield -999 dBm for each detector.
 - If the zoom is successful, the analyzer goes to zero span at this frequency
- Each detector is then read in successive single-point zero span sweeps, using a sweep time equal to the specified dwell time. The value displayed by Measure at Marker represents the maximum value output by the detector during the dwell time Autocoupled bandwidth and average type settings are used for each detector unless the **BW & Avg Type** key is set to **As Set**, in which case the current bandwidth and average type settings are used.
- Each result is then displayed in the measure at marker window as it becomes available.
- The analyzer returns to its pre-Measure at Marker span and settings after executing a Measure at Marker function, including Bandwidth, Avg Type, and EMC Std - regardless of the setting of **BW & Avg Type**
- Finally, if the sweep had to be aborted, the aborted sweep is restarted.

While the function is executing, all the fields except Freq show --- for their values until the measurement is complete for that detector. As each detector is read, an informational message is displayed in the status line, for example,

Measuring with detector 1 (Peak) with RBW=120 kHz

After the last detector, the status line is cleared.

Meas at Marker Window

This key opens a menu which controls the Measure at Marker window.

Key Path	Marker Function, Measure at Marker
Readback	In square brackets, the state of the window then the window position, separated by commas, as [On, Left]
Initial S/W Revision	A.02.00
Help Map ID	3818

Window

This key turns the Measure at Marker window on and off. It turns on automatically when Measure at Marker is initiated and turns off on a Preset. If the Window is turned on without a Measure at Marker result, --- is displayed for each result for which the detector is not "Off".

Key Path	Marker Function, Measure at Marker, Meas at Marker Window
Remote Command	:DISPlay:WINDow:MAMarker[:STATE] ON OFF 1 0 :DISPlay:WINDow:MAMarker[:STATE]?
Example	:DISP:WIND:MAM ON
Couplings	The window turns on automatically when Measure at Marker is initiated and turns off on a Preset.
Preset	Off
State Saved	Saved in instrument state
Readback Text	On Off
Initial S/W Revision	A.02.00
Help Map ID	3819

Position

This key controls the placement of the Measure at Marker window on the display.

Key Path	Marker Function, Measure at Marker, Meas at Marker Window
Remote Command	:DISPlay:WINDow:MAMarker:POSition LEFT RIGHT :DISPlay:WINDow:MAMarker:POSition?
Example	:DISP:WIND:MAM:POS RIGH
Preset	Right
State Saved	Saved in instrument state
Readback Text	Left Right
Initial S/W Revision	A.02.00

Common Measurement Functions 1

Help Map ID	3820
-------------	------

Detectors

This key opens up a menu that allows you to configure the detectors to be used for the Measure at Marker reading. Any of the analyzer's detectors can be used for each of the three detectors, or any of the three can be turned off. The dwell time for each detector is also settable.

When performing a Meas at Marker, the dwell time settings that you select will depend on the characteristics of the emission you are measuring. The default dwell time (200 ms) should work well for typical EUT emissions, but sometimes you will encounter emissions for which the defaults are not optimal. This is especially the case for emissions that vary slowly over time or have a slow repetition rate. By lengthening the dwell times you can increase the likelihood of accurately measuring these low repetition rate signals.

When Measure at marker is activated, the receiver makes a zero span measurement for each of the (up to) three detectors selected, using the Dwell Time set for each detector. If the signal's repetition period is greater than 200 ms (the default setting), the dwell time should be increased to capture at least two and preferably more repetitions of the signal. Additionally, if you do not need or do not wish to use a detector to make a measurement, that specific detector may be turned off.

If the Measure at Marker window is being displayed, and one of the detectors is changed, any value being displayed for that detector changes to "---" until the next successful reading from that detector.

Key Path	Marker Function, Measure at Marker,
Remote Command	:CALCulate:MAMarker:DETECTOR[1] 2 3 OFF NORMAl AVERAge POSitive SAMPlE NEGative QPEak EAVERage RAVERage :CALCulate:MAMarker:DETECTOR[1] 2 3?
Example	:CALC:MAM:DET2 QPE Sets the detector for measure at marker detector 2 to Quasi peak :CALC:MAM:DET OFF Sets the detector for measure at marker detector 1 to Off
State Saved	Saved in instrument state
Initial S/W Revision	A.02.00
Help Map ID	3821

Key Path	Marker Function, Measure at Marker,
Remote Command	:CALCulate:MAMarker:DETECTOR[1] 2 3:DWELl <dwell time> :CALCulate:MAMarker:DETECTOR[1] 2 3:DWELl?
Example	:CALC:MAM:DET2:DWEL 500 ms Sets the detector for measure at marker detector 2 to dwell for 500 ms
State Saved	Saved in instrument state

Backwards Compatibility SCPI	[:SENSe]:EMI:MEASure:DETEctor:DWELl <dwel time> Sets all of the detectors dwell time to the specified amount
Initial S/W Revision	A.02.00
Help Map ID	0

Detector 1

This menu lets you select the detector to be used for Detector 1, or turn Detector 1 off. This is a 1-of-N menu that shows the normal list of detectors, but with the “Auto” key replaced by “Off”.

Key Path	Marker Function, Measure at Marker, Detectors
Remote Command	See “ Detectors ” on page 1386.
Example	:CALC:MAM:DET QPE Sets the detector for measure at marker detector 1 to Quasi peak :CALC:MAM:DET OFF Sets the detector for measure at marker detector 1 to Off
Preset	Peak
State Saved	Saved in instrument state
Readback Text	Detector name
Initial S/W Revision	A.02.00
Help Map ID	3822

Detector 2

This menu lets you select the detector to be used for Detector 2, or turn Detector 2 off. This is a 1-of-N menu that shows the normal list of detectors, but with the “Auto” key replaced by “Off”.

Key Path	Marker Function, Measure at Marker, Detectors
Remote Command	See “ Detectors ” on page 1386.
Example	:CALC:MAM:DET2 QPE Sets the detector for measure at marker detector 2 to Quasi peak :CALC:MAM:DET2 OFF Sets the detector for measure at marker detector 2 to Off
Preset	Quasi Peak
State Saved	Saved in instrument state
Readback Text	Detector name

Common Measurement Functions 1

Backwards Compatibility SCPI	[:SENSe]:EMI:MEASure:DETEctor:QPEak[:STATe] OFF ON 0 1 If sent with On as a parameter, sets detector 2 to Quasi Peak If sent with Off as a parameter, sets detector 2 to Off
Initial S/W Revision	A.02.00
Help Map ID	3823

Detector 3

This menu lets you select the detector to be used for Detector 3, or turn Detector 3 off. This is a 1-of-N menu that shows the normal list of detectors, but with the “Auto” key replaced by “Off”.

Key Path	Marker Function, Measure at Marker, Detectors
Remote Command	See “Detectors” on page 1386.
Example	:CALC:MAM:DET3 QPE Sets the detector for measure at marker detector 1 to Quasi peak :CALC:MAM:DET3 OFF Sets the detector for measure at marker detector 1 to Off
Preset	EMI Average
State Saved	Saved in instrument state
Readback Text	Detector name
Backwards Compatibility SCPI	[:SENSe]:EMI:MEASure:DETEctor:AVERage[:STATe] OFF ON 0 1 If sent with On as a parameter, sets detector 3 to EMI Average If sent with Off as a parameter, sets detector 3 to Off
Initial S/W Revision	A.02.00
Help Map ID	3824

Detector 1 Dwell Time

This is the time specified by the user to dwell while taking the measurement for detector 1. The minimum allowed dwell time is based on the current detector. If “Off” is selected for detector 1, this key is grayed out and shows 200 ms.

Key Path	Marker Function, Measure at Marker, Detectors
Remote Command	See “Detectors” on page 1386.
Example	:CALC:MAM:DET:DWEL 400 ms Sets the dwell time for detector 1 to 400 ms
Preset	200 ms
State Saved	Saved in instrument state

Min	1 ms
Max	60 s
Initial S/W Revision	A.02.00
Default Unit	s
Help Map ID	3825

Detector 2 Dwell Time

This is the time specified by the user to dwell while taking the measurement for detector 2. The minimum allowed dwell time is based on the current detector. If “Off” is selected for detector 2, this key is grayed out and shows 200 ms.

Key Path	Marker Function, Measure at Marker, Detectors
Remote Command	See “ Detectors ” on page 1386.
Example	:CALC:MAM:DET2:DWEL 400 ms Sets the dwell time for detector 2 to 400 ms
Preset	200 ms
State Saved	Saved in instrument state
Min	1 ms
Max	60 s
Initial S/W Revision	A.02.00
Default Unit	s
Help Map ID	3826

Detector 3 Dwell Time

This is the time specified by the user to dwell while taking the measurement for detector 3. The minimum allowed dwell time is based on the current detector. If “Off” is selected for detector 3, this key is grayed out and shows 200 ms.

Key Path	Marker Function, Measure at Marker, Detectors
Remote Command	See “ Detectors ” on page 1386.
Example	:CALC:MAM:DET3:DWEL 400 ms Sets the dwell time for detector 1 to 400 ms
Preset	200 ms
State Saved	Saved in instrument state
Min	1 ms
Max	60 s

Common Measurement Functions 1

Initial S/W Revision	A.02.00
Default Unit	s
Help Map ID	3827

BW & Avg Type

This key controls the type of bandwidth and average type coupling used in Measure at Marker.

If set to “Autocoupled”, then the RBW and Average Type are selected by the instrument during the Measure at Marker function, according to the normal Autocouple rules, regardless of whether RBW and Average Type are currently in Auto. If set to “As Set”, then the current value for RBW and Average Type are used (which of course, could also be “Auto”).

Here are the details of the two modes:

If **BW & Avg Type** is set to **Autocoupled**, **Measure at Marker** behaves as follows:

1. The **EMC Std** changes to CISPR if any of the CISPR detectors (EMI Avg, RMS Avg, QPD) becomes selected; for all other detectors, the value of **EMC Std** that existed before Measure at Marker is used.
2. **RBW** autocouples throughout Measure at Marker, even if **RBW** is set to **Manual**. The autocouple rules are based on whatever the instantaneous setting of EMC Std, Span, and Center Freq are.

If **BW & Avg Type** is set to **As Set**, **Measure at Marker** behaves as follows:

1. The **EMC Std** never changes; so if it is set to **None** it stays at **None** throughout, even if one of the CISPR detectors is selected.
2. If **RBW** is set to **Auto**, then **RBW** autocouples throughout Measure at Marker. The autocouple rules are based on whatever the setting of EMC Std, Span, and Center Freq are.
3. If **RBW** is set to **Manual**, the RBW never changes at all throughout Measure at Marker, it stays at the value to which it was set before Measure at Marker began.

The analyzer returns to its pre-Measure at Marker span and settings after executing a Measure at Marker function, including Bandwidth, Avg Type, and EMC Std.

It is important to note that, when RBW is coupled to Frequency, as it is when **EMC Std** is anything but “None”, for all EMI measurements, the frequency it is coupled to for Measure at Marker is the MARKER frequency, not the Center Frequency.

Key Path	Marker Function, Measure at Marker
Remote Command	:CALCulate:MAMarker:COUPling ON OFF 1 0 :CALCulate:MAMarker:COUPling?
Example	:CALC:MAM:COUP ON
Preset	Autocoupled
State Saved	Saved in instrument state
Readback Text	Autocoupled As Set
Initial S/W Revision	A.02.00

Help Map ID	3828
-------------	------

Center Presel On/Off

This key controls the automatic centering of the preselector for the Measure at Marker function.

When Center Presel is On, the first step in performing the Measure at Marker function is to perform a Presel Center. This is not performed if the microwave preselector is off, or the selected marker's frequency is below Band 1. If the function is not performed, no message is generated.

Key Path	Marker Function, Measure at Marker
Remote Command	:CALCulate:MAMarker:PCENter ON OFF 1 0 :CALCulate:MAMarker:PCENter?
Example	:CALC:MAM:PCEN ON
Dependencies	Blank in models that do not include a preselector, such as option 503. If the SCPI is sent in these instruments, it is accepted without error, and the query always returns 0.
Preset	On
Backwards Compatibility SCPI	[:SENSe]:EMI:MEASure:PCENter[:STATe] OFF ON 0 1 [:SENSe]:EMI:MEASure:PCENter[:STATe]?
Initial S/W Revision	A.02.00
Help Map ID	3829

Marker To

The Marker -> key accesses menu keys that can copy the current marker value into other test set parameters (for example, Center Freq). The currently selected marker is made the active function on entry to this menu (if the currently selected marker is not on when you press this front-panel key, it is turned on at the center of the screen as a normal type marker and then made the active function).

The **Marker ->** (or Marker To) feature is used to quickly assign a marker's x- or y-axis value to another parameter. For example, if a marker's x-axis value is 500 MHz and y-axis value is -20 dBm, pressing **Mkr -> CF** would assign 500 MHz to **Center Freq** and pressing **Mkr ->Ref Lvl** would assign -20 dBm to **Ref Level**.

Notes	All Marker To functions executed from the front panel use the selected marker's values, while all Marker To remote commands specify in the command which marker's value to use. Consistent with other remote marker commands, sending a Marker To remote command will never change which marker is selected.
Initial S/W Revision	Prior to A.02.00
Help Map ID	3192

Common Measurement Functions 1

Mkr->CF

Sets the center frequency of the test set to the frequency of the selected marker. The marker stays at this frequency, so it moves to the center of the display. In delta marker mode, this function sets the center frequency to the x-axis value of the delta marker. When the frequency scale is in log mode, the center frequency is not at the center of the display.

If the currently selected marker is not on when this key is pressed, it is turned on at the center of the screen as a normal type marker.

Key Path	Marker ->
Remote Command	:CALCulate:MARKer [1] 2 3 4 5 6 7 8 9 10 11 12 [:SET] :CEN Ter
Example	CALC:MARK2:CENt sets the CF of the test set to the value of marker 2.
Notes	Sending this command selects the subopcoded marker If specified marker is off, this command will turn it on at the center of the screen as a normal type marker.
Dependencies	This function is not available (key is grayed out) when x-axis is the time domain
Couplings	All the usual couplings associated with setting Center Frequency apply (see the Frequency Section).
Initial S/W Revision	Prior to A.02.00
Help Map ID	3193

Mkr->CF Step

Sets the center frequency (CF) step size of the test set to the marker frequency, or in a delta-marker mode, to the frequency difference between the delta and reference markers.

If the currently selected marker is not on when this key is pressed, it is turned on at the center of the screen as a normal type marker.

Key Path	Marker ->
Remote Command	:CALCulate:MARKer [1] 2 3 4 5 6 7 8 9 10 11 12 [:SET] :STE P
Example	CALC:MARK1:STEP sets the CF step to the value (or delta value) of marker 1.
Notes	Sending this command selects the subopcoded marker If specified marker is off, this command will turn it on at the center of the screen as a normal type marker.
Dependencies	This function is not available (key is grayed out) when x-axis is the time domain

Couplings	All the usual couplings associated with setting CF Step apply (see the Frequency Section).
Initial S/W Revision	Prior to A.02.00
Help Map ID	3194

Mkr->Start

Changes the start frequency to the frequency of the selected marker. The marker stays at this frequency, so it moves to the left edge of the display. In delta marker mode, this function sets the start frequency to the x-axis value of the delta marker.

If the currently selected marker is not on when this key is pressed, it is turned on at the center of the screen as a normal type marker.

Key Path	Marker ->
Remote Command	:CALCulate:MARKer [1] 2 3 4 5 6 7 8 9 10 11 12 [:SET] :STARt
Example	CALC:MARK1:STAR sets the start frequency to the value (or delta value) of marker 1.
Notes	Sending this command selects the subopcoded marker If specified marker is off, this command will turn it on at the center of the screen as a normal type marker.
Dependencies	This function is not available (key is grayed out) when x-axis is the time domain
Couplings	All the usual couplings associated with setting Start Frequency apply (see the Frequency Section).
Initial S/W Revision	Prior to A.02.00
Help Map ID	3195

Mkr->Stop

Changes the stop frequency to the frequency of the selected marker. The marker stays at this frequency, so it moves to the right edge of the display. In delta marker mode, this function sets the stop frequency to the x-axis value of the delta marker.

If the currently selected marker is not on when this key is pressed, it is turned on at the center of the screen as a normal type marker.

Key Path	Marker ->
Remote Command	:CALCulate:MARKer [1] 2 3 4 5 6 7 8 9 10 11 12 [:SET] :STOP
Example	CALC:MARK3:STOP sets the stop frequency to the value (or delta value) of marker 3.

Common Measurement Functions 1

Notes	Sending this command selects the subcoded marker If specified marker is off, this command will turn it on at the center of the screen as a normal type marker.
Dependencies	This function is not available (key is grayed out) when x-axis is the time domain
Couplings	All the usual couplings associated with setting Stop Frequency apply (see the Frequency Section).
Initial S/W Revision	Prior to A.02.00
Help Map ID	3196

Mkr Δ ->Span

Sets the start and stop frequencies to the values of the delta markers. That is, it moves the lower of the two marker frequencies to the start frequency and the higher of the two marker frequencies to the stop frequency. The marker mode is unchanged and the two markers (delta and reference) end up on opposite edges of the display.

Key Path	Marker ->
Remote Command	:CALCulate:MARKer [1] 2 3 4 5 6 7 8 9 10 11 12 [:SET] :DEL Ta:SPAN
Example	CALC:MARK2:DELT:SPAN sets the start and stop frequencies to the values of marker 2 and its reference marker.
Notes	Sending this command selects the subcoded marker
Dependencies	This function is only available when the selected marker is a delta marker. Otherwise the key is grayed out. In addition, this function is not available when x-axis is the time domain
Couplings	All the usual couplings associated with setting Span apply (see the Section “Span” on page 1745 ”).
Backwards Compatibility SCPI	:CALCulate:MARKer[1] 2 3 4 5 6 7 8 9 10 11 12[:SET]:SPAN
Initial S/W Revision	Prior to A.02.00
Help Map ID	3197

Mkr Δ ->CF

Sets the center frequency to the frequency difference between the selected marker and its reference marker. The marker is then changed to a Normal marker and placed at the center of span.

Key Path	Marker ->
Remote Command	:CALCulate:MARKer [1] 2 3 4 5 6 7 8 9 10 11 12 [:SET] :DEL Ta:CENTer
Example	CALC:MARK2:CENt sets the CF of the test set to the value of marker 2.

Notes	Sending this command selects the subopcoded marker
Dependencies	This function is only available when the selected marker is a delta marker. Otherwise the key is grayed out. In addition, this function is not available when x-axis is the time domain
Initial S/W Revision	Prior to A.02.00
Help Map ID	3198

Mkr->Ref Lvl

Sets the reference level to the amplitude value of the selected marker, moving the marked point to the reference level (top line of the graticule). The marker’s mode (Normal, Delta, Fixed) doesn’t matter in this case. For example, given a delta marker, if the delta marker is the selected marker, its amplitude is applied to the reference level. If the reference marker is selected, its amplitude is applied to the reference level.

If the currently selected marker is not on when this key is pressed, it is turned on at the center of the screen as a normal type marker, and its amplitude applied to the reference level.

Key Path	Marker ->
Remote Command	:CALCulate:MARKer [1] 2 3 4 5 6 7 8 9 10 11 12 [:SET] :RLEVel
Example	CALC:MARK2:RLEV sets the reference level of the test set to the amplitude of marker 2.
Notes	Sending this command selects the subopcoded marker If specified marker is off, this command will turn it on at the center of the screen as a normal type marker.
Couplings	All the usual couplings associated with setting Reference Level apply.
Initial S/W Revision	Prior to A.02.00
Help Map ID	3199

Meas

The information in this section is common to all measurements. For key and remote command information for a specific measurement, refer to the section that describes the measurement of interest.

Measurements available under the Meas key are specific to the current Mode.

When viewing Help for measurements, note the following:

NOTE Operation for some keys differs between measurements. The information displayed in Help pertains to the current measurement. To see how a key operates in a different measurement, exit Help (press the Cancel Esc key), select the

Common Measurement Functions 1

measurement, then reenter Help (press the Help key) and press that key.

Key Path:	Front-panel key
Initial S/W Revision:	Prior to A.02.00
Help Map ID:	4008

Remote Measurement Functions

This section contains the following topics:

[“Measurement Group of Commands” on page 1397](#)

[“Current Measurement Query \(Remote Command Only\) ” on page 1400](#)

[“Limit Test Current Results \(Remote Command Only\)” on page 1400](#)

[“Data Query \(Remote Command Only\)” on page 1400](#)

[“Calculate/Compress Trace Data Query \(Remote Command Only\)” on page 1400](#)

[“Calculate Peaks of Trace Data \(Remote Command Only\)” on page 1405](#)

[“Format Data: Numeric Data \(Remote Command Only\)” on page 1407](#)

[“Format Data: Byte Order \(Remote Command Only\)” on page 1409](#)

Initial S/W Revision:	Prior to A.02.00
Help Map ID:	29978

Measurement Group of Commands

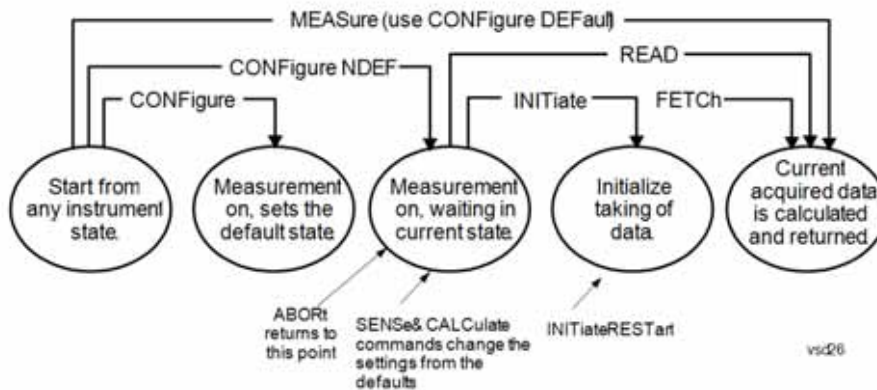
**Measure Commands:****:MEASure:<measurement>[n]?**

This is a fast single-command way to make a measurement using the factory default instrument settings. These are the settings and units that conform to the Mode Setup settings (e.g. radio standard) that you have currently selected.

- Stops the current measurement (if any) and sets up the instrument for the specified measurement using the factory defaults
- Initiates the data acquisition for the measurement
- Blocks other SCPI communication, waiting until the measurement is complete before returning results.
- If the function does averaging, it is turned on and the number of averages is set to 10.
- After the data is valid it returns the scalar results, or the trace data, for the specified measurement. The type of data returned may be defined by an [n] value that is sent with the command.

The scalar measurement results will be returned if the optional [n] value is not included, or is set to 1. If the [n] value is set to a value other than 1, the selected trace data results will be returned. See each command for details of what types of scalar results or trace data results are available.

ASCII is the default format for the data output. (Older versions of Spectrum Analysis and Phase Noise mode measurements only use ASCII.) The binary data formats should be used for handling large blocks of data since they are smaller and faster than the ASCII format. Refer to the FORMat:DATA command for more information.

If you need to change some of the measurement parameters from the factory default settings you can set up the measurement with the CONFIgure command. Use the commands in the SENSE:<measurement> and CALCulate:<measurement> subsystems to change the settings. Then you can use the READ? command to initiate the measurement and query the results.

If you need to repeatedly make a given measurement with settings other than the factory defaults, you can use the commands in the SENSE:<measurement> and CALCulate:<measurement> subsystems to set up the measurement. Then use the READ? command to initiate the measurement and query results.

Measurement settings persist if you initiate a different measurement and then return to a previous one. Use READ:<measurement>? if you want to use those persistent settings. If you want to go back to the default settings, use MEASure:<measurement>?.

Common Measurement Functions 1

Measure Commands:
Configure Commands:
:CONFigure:<measurement> This command stops the current measurement (if any) and sets up the instrument for the specified measurement using the factory default instrument settings. It does not initiate the taking of measurement data unless INIT:CONTinuous is ON. If you change any measurement settings after using the CONFigure command, the READ command can be used to initiate a measurement without changing the settings back to their defaults. :CONFigure:NDEFault<measurement> stops the current measurement and changes to the specified measurement. It does not change the settings to the defaults. It does not initiate the taking of measurement data unless INIT:CONTinuous is ON. The CONFigure? query returns the current measurement name. The CONFigure:CATalog? query returns a quoted string of all licensed measurement names in the current mode. For example, "SAN, CHP, OBW, ACP, PST, TXP, SPUR, SEM, LIST".
Fetch Commands:
:FETCh:<measurement>[n]? This command puts selected data from the most recent measurement into the output buffer. Use FETCh if you have already made a good measurement and you want to return several types of data (different [n] values, for example, both scalars and trace data) from a single measurement. FETCh saves you the time of re-making the measurement. You can only FETCh results from the measurement that is currently active, it will not change to a different measurement. An error message is reported if a measurement other than the current one is specified. If you need to get new measurement data, use the READ command, which is equivalent to an INITiate followed by a FETCh. The scalar measurement results will be returned if the optional [n] value is not included, or is set to 1. If the [n] value is set to a value other than 1, the selected trace data results will be returned. See each command for details of what types of scalar results or trace data results are available. The binary data formats should be used for handling large blocks of data since they are smaller and transfer faster than the ASCII format. (FORMat:DATA) FETCh may be used to return results other than those specified with the original READ or MEASure command that you sent.
INITiate Commands:

Measure Commands:	
:INITiate:<measurement>	
<p>This command is not available for measurements in all the instrument modes:</p> <ul style="list-style-type: none"> • Initiates a trigger cycle for the specified measurement, but does not output any data. You must then use the FETCh<meas> command to return data. If a measurement other than the current one is specified, the instrument will switch to that measurement and then initiate it. • For example, suppose you have previously initiated the ACP measurement, but now you are running the channel power measurement. If you send INIT:ACP? it will change from channel power to ACP and will initiate an ACP measurement. • Does not change any of the measurement settings. For example, if you have previously started the ACP measurement and you send INIT:ACP? it will initiate a new ACP measurement using the same instrument settings as the last time ACP was run. • If your selected measurement is currently active (in the idle state) it triggers the measurement, assuming the trigger conditions are met. Then it completes one trigger cycle. Depending upon the measurement and the number of averages, there may be multiple data acquisitions, with multiple trigger events, for one full trigger cycle. It also holds off additional commands on GPIB until the acquisition is complete. 	
READ Commands:	
:READ:<measurement>[n]?	
<ul style="list-style-type: none"> • Does not preset the measurement to the factory default settings. For example, if you have previously initiated the ACP measurement and you send READ:ACP? it will initiate a new measurement using the same instrument settings. • Initiates the measurement and puts valid data into the output buffer. If a measurement other than the current one is specified, the instrument will switch to that measurement before it initiates the measurement and returns results. <p>For example, suppose you have previously initiated the ACP measurement, but now you are running the channel power measurement. Then you send READ:ACP? It will change from channel power back to ACP and, using the previous ACP settings, will initiate the measurement and return results.</p> <ul style="list-style-type: none"> • Blocks other SCPI communication, waiting until the measurement is complete before returning the results <p>If the optional [n] value is not included, or is set to 1, the scalar measurement results will be returned. If the [n] value is set to a value other than 1, the selected trace data results will be returned. See each command for details of what types of scalar results or trace data results are available. The binary data formats should be used when handling large blocks of data since they are smaller and faster than the ASCII format. (FORMat:DATA)</p>	

Initial S/W Revision:	Prior to A.02.00
Help Map ID:	0

Common Measurement Functions 1

Current Measurement Query (Remote Command Only)

This command returns the name of the measurement that is currently running.

Remote Command:	:CONFIgure?
Example:	CONF?
Initial S/W Revision:	Prior to A.02.00
Help Map ID:	0

Limit Test Current Results (Remote Command Only)

Queries the status of the current measurement limit testing. It returns a 0 if the measured results pass when compared with the current limits. It returns a 1 if the measured results fail any limit tests.

Remote Command:	:CALCulate:CLIMits:FAIL?
Example:	CALC:CLIM:FAIL? queries the current measurement to see if it fails the defined limits. Returns a 0 or 1: 0 it passes, 1 it fails.
Initial S/W Revision:	Prior to A.02.00
Help Map ID:	0

Data Query (Remote Command Only)

Returns the designated measurement data for the currently selected measurement and subopcode.

n = any valid subopcode for the current measurement. See the measurement command results table for your current measurement, for information about what data is returned for the subopcodes.

This command uses the data setting specified by the FORMat:BORDER and FORMat:DATA commands and can return real or ASCII data. (See the format command descriptions under Input/Output in the Analyzer Setup section.)

Remote Command:	:CALCulate:DATA [n] ?
Notes:	The return trace depends on the measurement. In CALCulate:<meas>:DATA[n], n is any valid subopcode for the current measurement. It returns the same data as the FETCh:<measurement>? query where <measurement> is the current measurement.
Initial S/W Revision:	Prior to A.02.00
Help Map ID:	0

Calculate/Compress Trace Data Query (Remote Command Only)

Returns compressed data for the currently selected measurement and sub-opcode [n].

n = any valid sub-opcode for that measurement. See the MEASure:<measurement>? command description of your specific measurement for information on the data that can be returned.

The data is returned in the current Y Axis Unit of the test set. The command is used with a sub-opcode <n> (default=1) to specify the trace. With trace queries, it is best if the test set is not sweeping during the query. Therefore, it is generally advisable to be in Single Sweep, or Update=Off.

This command is used to compress or decimate a long trace to extract and return only the desired data. A typical example would be to acquire N frames of GSM data and return the mean power of the first burst in each frame. The command can also be used to identify the best curve fit for the data.

Remote Command:	:CALCulate:DATA<n>:COMPRESS? BLOCK CFIT MAXimum MINimum MEAN DMEan RMS RMSCubed SAMPLE SDEVIation PPHase [,<soffset>[,<length>[,<roffset>[,<rlimit>]]]]
Example:	To query the mean power of a set of GSM bursts: Supply a signal that is a set of GSM bursts. Select the IQ Waveform measurement (in IQ Analyzer Mode). Set the sweep time to acquire at least one burst. Set the triggers such that acquisition happens at a known position relative to a burst. Then query the mean burst levels using, CALC:DATA2:COMP? MEAN,24e-6,526e-6 (These parameter values correspond to GSM signals, where 526e-6 is the length of the burst in the slot and you just want 1 burst.)
Notes:	The command supports 5 parameters. Note that the last 4 (<soffset>,<length>,<roffset>,<rlimit>) are optional. But these optional parameters must be entered in the specified order. For example, if you want to specify <length>, then you must also specify <soffset>. See details below for a definition of each of these parameters. This command uses the data in the format specified by FORMat:DATA, returning either binary or ASCII data.
Initial S/W Revision:	Prior to A.02.00
Help Map ID:	0

- BLOCk or block data - returns all the data points from the region of the trace data that you specify. For example, it could be used to return the data points of an input signal over several timeslots, excluding the portions of the trace data that you do not want. (This is x,y pairs for trace data and I,Q pairs for complex data.)
- CFIT or curve fit - applies curve fitting routines to the data. <soffset> and <length> are required to define the data that you want. <roffset> is an optional parameter for the desired order of the curve equation. The query will return the following values: the x-offset (in seconds) and the curve coefficients ((order + 1) values).

MIN, MAX, MEAN, DME, RMS, RMSC, SAMP, SDEV and PPH return one data value for each specified region (or <length>) of trace data, for as many regions as possible until you run out of trace data (using <roffset> to specify regions). Or they return the number of regions you specify (using <rlimit>) ignoring any data beyond that.

- MINimum - returns the minimum data point (y value) for the specified region(s) of trace data. For I/Q

Common Measurement Functions 1

trace data, the minimum magnitude of the I/Q pairs is returned.

- **MAXimum** - returns the maximum data point (y value) for the specified region(s) of trace data. For I/Q trace data, the maximum magnitude of the I/Q pairs is returned.
- **MEAN** - returns a single value that is the arithmetic mean of the data point values (in dB/ dBm) for the specified region(s) of trace data. For I/Q trace data, the mean of the magnitudes of the I/Q pairs is returned. See the following equations.

NOTE

If the original trace data is in dB, this function returns the arithmetic mean of those log values, not log of the mean power which is a more useful value. The mean of the log is the better measurement technique when measuring CW signals in the presence of noise. The mean of the power, expressed in dB, is useful in power measurements such as Channel Power. To achieve the mean of the power, use the RMS option.

Equation 1

Mean Value of Data Points for Specified Region(s)

$$\text{MEAN} = \frac{1}{n} \sum_{X_i \in \text{region}(s)} X_i \quad \text{vsd27-1}$$

where X_i is a data point value, and n is the number of data points in the specified region(s).

Equation 2

Mean Value of I/Q Data Pairs for Specified Region(s)

$$\text{MEAN} = \frac{1}{n} \sum_{X_i \in \text{region}(s)} |X_i| \quad \text{vsd27-2}$$

where $|X_i|$ is the magnitude of an I/Q pair, and n is the number of I/Q pairs in the specified region(s).

- **DMEan** - returns a single value that is the mean power (in dB/ dBm) of the data point values for the specified region(s) of trace data. See the following equation:

Equation 3

DMEan Value of Data Points for Specified Region(s)

$$\text{DME} = 10 \times \log_{10} \left(\frac{1}{n} \sum_{X_i \in \text{region}(s)} 10^{\frac{X_i}{10}} \right) \quad \text{vsd27-3}$$

- **RMS** - returns a single value that is the average power on a root-mean-squared voltage scale (arithmetic rms) of the data point values for the specified region(s) of trace data. See the following equation.

NOTE For I/Q trace data, the rms of the magnitudes of the I/Q pairs is returned. See the following equation.

This function is very useful for I/Q trace data. However, if the original trace data is in dB, this function returns the rms of the log values which is not usually needed.

Equation 4
RMS Value of Data Points for Specified Region(s)

$$\text{RMS} = \sqrt{\frac{1}{n} \sum_{X_i \in \text{region}(s)} X_i^2}$$

vsd27-4

where X_i is a data point value, and n is the number of data points in the specified region(s).

Equation 5
RMS Value of I/Q Data Pairs for Specified Region(s)

$$\text{RMS} = \sqrt{\frac{1}{n} \sum_{X_i \in \text{region}(s)} X_i X_i^*}$$

vsd27-5

where X_i is the complex value representation of an I/Q pair, X_i^* its conjugate complex number, and n is the number of I/Q pairs in the specified region(s).

Once you have the rms value for a region of trace data (linear or I/Q), you may want to calculate the mean power. You must convert this rms value (peak volts) to power in dBm:

$$10 \times \log[10 \times (\text{rms value})^2]$$

- **SAMPLE** - returns the first data value (x,y pair) for the specified region(s) of trace data. For I/Q trace data, the first I/Q pair is returned.
- **SDEViation** - returns a single value that is the arithmetic standard deviation for the data point values for the specified region(s) of trace data. See the following equation.

For I/Q trace data, the standard deviation of the magnitudes of the I/Q pairs is returned. See the following equation.

Equation 6
Standard Deviation of Data Point Values for Specified Region(s)

$$\text{SDEV} = \sqrt{\frac{1}{n} \sum_{X_i \in \text{region}(s)} (X_i - \bar{X})^2}$$

vsd27-7

where X_i is a data point value, \bar{X} is the arithmetic mean of the data point values for the specified

Common Measurement Functions 1

region(s), and n is the number of data points in the specified region(s).

$$\text{SDEV} = \sqrt{\frac{1}{n} \sum_{X_i \in \text{region}(s)} (|X_i| - \bar{X})^2}$$

vsd27-8

where $|X_i|$ is the magnitude of an I/Q pair, \bar{X} is the mean of the magnitudes for the specified region(s), and n is the number of data points in the specified region(s).

- PPHase - returns the x,y pairs of both rms power (dBm) and arithmetic mean phase (radian) for every specified region and frequency offset (Hz). The number of pairs is defined by the specified number of regions. This parameter can be used for I/Q vector (n=0) in Waveform (time domain) measurement and all parameters are specified by data point in PPHase.

The rms power of the specified region may be expressed as:

$$\text{Power} = 10 \times \log [10 \times (\text{RMS I/Q value})] + 10.$$

The RMS I/Q value (peak volts) is:

$$\sqrt{\frac{1}{n} \sum_{X_i \in \text{region}} X_i X_i^*}$$

vsd27-9

where X_i is the complex value representation of an I/Q pair, X_i^* its conjugate complex number, and n is the number of I/Q pairs in the specified region.

The arithmetic mean phase of the specified region may be expressed as:

$$\frac{1}{n} \sum_{Y_i \in \text{region}} Y_i$$

vsd27-10

where Y_i is the unwrapped phase of I/Q pair with applying frequency correction and n is the number of I/Q pairs in the specified region.

The frequency correction is made by the frequency offset calculated by the arithmetic mean of every specified region's frequency offset. Each frequency offset is calculated by the least square method against the unwrapped phase of I/Q pair.

Sample Trace Data - Constant Envelope

(See below for explanation of variables.)

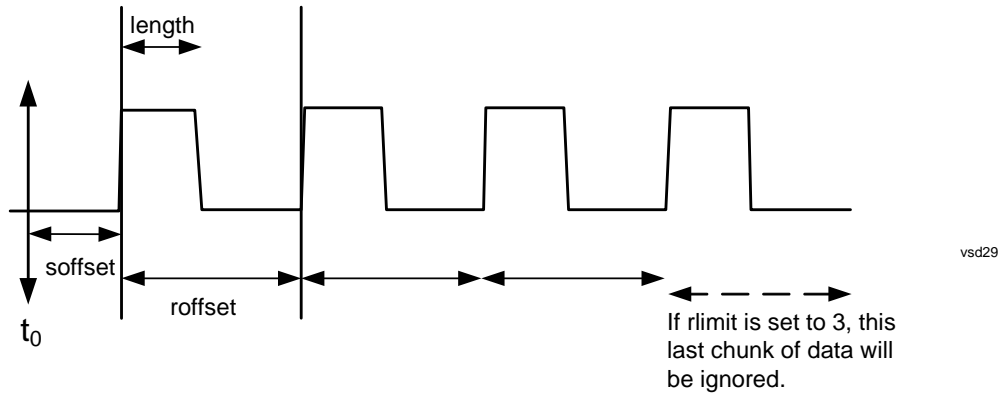

Sample Trace Data - Not Constant Envelope

(See below for explanation of variables.)

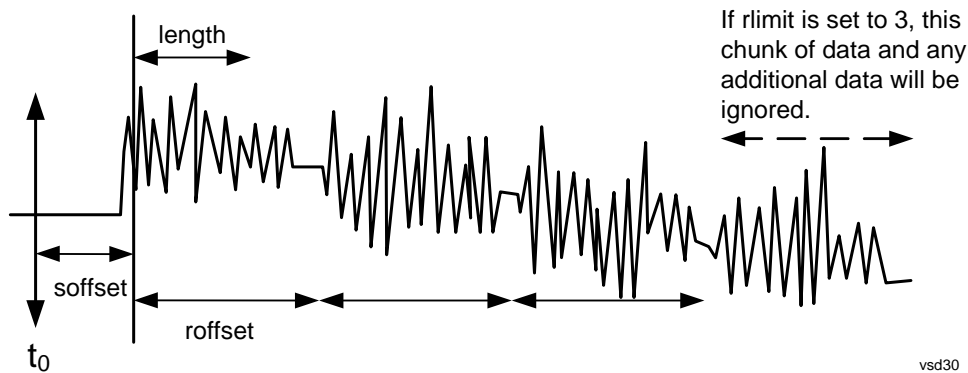

`<soffset>` - start offset is an optional real number. (It is in seconds for time-domain traces, and is a dimensionless index 0 to $N_{\text{points}} - 1$, for frequency-domain traces). It specifies the amount of data at the beginning of the trace that will be ignored before the decimation process starts. It is the time or frequency change from the start of the trace to the point where you want to start using the data. The default value is zero.

`<length>` - is an optional real number. (It is in seconds for time-domain traces, and is a dimensionless index 0 to $N_{\text{points}} - 1$, for frequency-domain traces). It defines how much data will be compressed into one value. This parameter has a default value equal to the current trace length.

`<roffset>` - repeat offset is an optional real number. (It is in seconds for time-domain traces, and is a dimensionless index 0 to $N_{\text{points}} - 1$, for frequency-domain traces). It defines the beginning of the next field of trace elements to be compressed. This is relative to the beginning of the previous field. This parameter has a default value equal to the `<length>` variable. Note that this parameter is used for a completely different purpose when curve fitting (see CFIT above).

`<rlimit>` - repeat limit is an optional integer. It specifies the number of data items that you want returned. It will ignore any additional items beyond that number. You can use the Start offset and the Repeat limit to pick out exactly what part of the data you want to use. The default value is all the data.

Calculate Peaks of Trace Data (Remote Command Only)

Returns a list of all the peaks for the currently selected measurement and sub-opcode [n]. The peaks must meet the requirements of the peak threshold and excursion values.

Common Measurement Functions 1

n = any valid sub-opcode for the current measurement. See the MEASure:<measurement> command description of your specific measurement for information on the data that can be returned.

The command can only be used with specific sub-opcodes with measurement results that are trace data. Both real and complex traces can be searched, but complex traces are converted to magnitude in dBm. In many measurements the sub-opcode n=0, is the raw trace data which cannot be searched for peaks. And Sub-opcode n=1, is often calculated results values which also cannot be searched for peaks.

This command uses the data setting specified by the FORMat:BORDER and FORMat:DATA commands and can return real or ASCII data. If the format is set to INT,32, it returns REAL,32 data.

The command has four types of parameters:

- Threshold (in dBm)
- Excursion (in dB)
- Sorting order (amplitude, frequency, time)
- Optional in some measurements: Display line use (all, > display line, < display line)

Remote Command:	:CALCulate:DATA [1] 2 3 4 5 6 :PEAKs? <threshold>, <excursion> [, AMPLitude FREQuency TIME]
Example:	<p>CALC:DATA4:PEAK? -40,10,FREQ,GTDL This will identify the peaks of trace 4 that are above -40 dBm, with excursions of at least 10 dB. The peaks are returned in order of increasing frequency, starting with the lowest frequency. Only the peaks that are above the display line are returned.</p> <p>Query Results 1:</p> <p>With FORMat:DATA REAL,32 selected, it returns a list of floating-point numbers. The first value in the list is the number of peak points that are in the following list. A peak point consists of two values: a peak amplitude followed by its corresponding frequency (or time).</p> <p>If no peaks are found the peak list will consist of only the number of peaks, (0).</p>

Notes:	<p><n> - is the trace that will be used</p> <p><threshold> - is the level below which trace data peaks are ignored. Note that the threshold value is required and is always used as a peak criterion. To effectively disable the threshold criterion for this command, provide a substantially low threshold value such as -200 dBm. Also note that the threshold value used in this command is independent of and has no effect on the threshold value stored under the Peak Criteria menu.</p> <p><excursion> - is the minimum amplitude variation (rise and fall) required for a signal to be identified as peak. Note that the excursion value is required and is always used as a peak criterion. To effectively disable the excursion criterion for this command, provide the minimum value of 0.0 dB. Also note that the excursion value used in this command is independent of and has no effect on the excursion value stored under the Peak Criteria menu.</p> <p>Values must be provided for threshold and excursion. The sorting and display line parameters are optional (defaults are AMPLitude and ALL).</p> <p>Note that there is always a Y-axis value for the display line, regardless of whether the display line state is on or off. It is the current Y-axis value of the display line which is used by this command to determine whether a peak should be reported</p> <p>Sorting order:</p> <p>AMPLitude - lists the peaks in order of descending amplitude, with the highest peak first (default if optional parameter not sent)</p> <p>FREQuency - lists the peaks in order of occurrence, left to right across the x-axis.</p> <p>TIME - lists the peaks in order of occurrence, left to right across the x-axis.</p> <p>Peaks vs. Display Line:</p> <p>ALL - lists all of the peaks found (default if optional parameter not sent).</p> <p>GTDLine (greater than display line) - lists all of the peaks found above the display line.</p> <p>LTDLine (less than display line) - lists all of the peaks found below the display line.</p>
Initial S/W Revision:	Prior to A.02.00
Help Map ID:	0

Format Data: Numeric Data (Remote Command Only)

This command specifies the format of the trace data input and output. It specifies the formats used for trace data during data transfer across any remote port. It affects only the data format for setting and querying trace data for the :TRACe[:DATA], TRACe[:DATA]?, :CALCulate:DATA[n]? and FETCh:SANalyzer[n]? commands and queries.

Remote Command:	<p>:FORMat [:TRACe] [:DATA] ASCii INTeger, 32 REAL, 32 REAL, 64</p> <p>:FORMat [:TRACe] [:DATA] ?</p>
------------------------	---

Common Measurement Functions 1

Notes:	<p>The query response is:</p> <p>ASCii: ASC,8</p> <p>REAL,32: REAL,32</p> <p>REAL,64: REAL,64</p> <p>INTeger,32: INT,32</p> <p>When the numeric data format is REAL or ASCii, data is output in the current Y Axis unit. When the data format is INTeger, data is output in units of m dBm (.001 dBm).</p> <p>The INT,32 format returns binary 32-bit integer values in internal units (m dBm), in a definite length block.</p>
Dependencies:	<p>Sending a data format spec with an invalid number (for example, INT,48) generates no error. The test set simply uses the default (8 for ASCii, 32 for INTeger, 32 for REAL).</p> <p>Sending data to the test set which does not conform to the current FORMat specified, results in an error. Sending ASCII data when a definite block is expected generates message -161 "Invalid Block Data" and sending a definite block when ASCII data is expected generates message -121 "Invalid Character in Number".</p>
Preset:	ASCii
Backwards Compatibility Notes:	Note that the INT,32 format is only applicable to the command, TRACe:DATA. This preserves backwards compatibility for the Swept SA measurement. For all other commands/queries which honor FORMat:DATA, if INT,32 is sent the analyzer will behave as though it were set to REAL,32.
Initial S/W Revision:	Prior to A.02.00
Help Map ID:	0

The specs for each output type follow:

ASCii - Amplitude values are in ASCII, in the current Y Axis Unit, one ASCII character per digit, values separated by commas, each value in the form:

SX.YYYYYEsZZ

Where:

S = sign (+ or -)

X = one digit to left of decimal point

Y = 5 digits to right of decimal point

E = E, exponent header

s = sign of exponent (+ or -)

ZZ = two digit exponent

REAL,32 - Binary 32-bit real values in the current Y Axis Unit, in a definite length block.

REAL,64 - Binary 64-bit real values in the current Y Axis Unit, in a definite length block.

Format Data: Byte Order (Remote Command Only)

This command selects the binary data byte order for data transfer and other queries. It controls whether binary data is transferred in normal or swapped mode. This command affects only the byte order for setting and querying trace data for the :TRACe[:DATA], TRACe[:DATA]? , :CALCulate:DATA[n]? and FETCh:SANalyzer[n]? commands and queries.

By definition any command that says it uses FORMat:DATA uses any format supported by FORMat:DATA.

The NORMAl order is a byte sequence that begins with the most significant byte (MSB) first, and ends with the least significant byte (LSB) last in the sequence: 1|2|3|4. SWAPped order is when the byte sequence begins with the LSB first, and ends with the MSB last in the sequence: 4|3|2|1.

Remote Command:	:FORMat:BORDER NORMAl SWAPped :FORMat:BORDER?
Preset:	NORMAl
Initial S/W Revision:	Prior to A.02.00
Help Map ID:	0

Meas Setup

The Meas Setup key opens up a menu of keys that allow you to control the most important parameters for the current measurement.

NOTE In the Meas Setup menu you may configure Averaging, by setting the Average Number and the Average Type.

Key Path	Front-panel key
Initial S/W Revision	Prior to A.02.00
Help Map ID	3202

Average/Hold Number

Sets the terminal count number N for **Average**, **Max Hold** and **Min Hold** trace types. This number is an integral part of how the average trace is calculated. Basically, increasing N results in a smoother average trace.

See [“More Information” on page 1410](#).

See [“AVER:CLE command” on page 1410](#).

Key Path	Meas Setup
----------	-------------------

Common Measurement Functions 1

Remote Command	[:SENSE] :AVERAge:COUNT <integer> [:SENSE] :AVERAge:COUNT?
Couplings	Restarting any of these functions (Average, Max Hold or Min Hold) restarts all of them, as there is only one count.
Preset	100
State Saved	Saved in Instrument State
Min	1
Max	10000
Status Bits/OPC dependencies	See the Section Sweep/Control@3273 for a discussion of the Sweeping, Measuring, Settling and OPC bits, and the Hi Sweep line. All are affected when a sequence is reset.
Initial S/W Revision	Prior to A.02.00
Help Map ID	3203

More Information

AVER:CLE command

The AVER:CLE command (below) resets the average/hold count and does an INIT:IMM, which begins another set of sweeps when trigger conditions are satisfied. It only does this if an active trace is in Average or Hold type.

Remote Command:	[:SENSE] :AVERAge:CLEAr
Example:	AVER:COUN 100 AVER:CLE sets the current count (k and K) to 1 and restarts the averaging process.
Notes:	When the test set receives this command it performs an INIT:IMM, if and only if there is an active trace in Max Hold, Min Hold, or Average type.
Default Unit:	Enter
Initial S/W Revision:	Prior to A.02.00
Help Map ID:	3204

Average Type

Lets you control the way averaging is done by choosing one of the following averaging scales: log-power (video), power (RMS), or voltage averaging. Also lets you choose Auto Average Type (default).

When performing Trace Averaging, the equation that is used to calculate the averaged trace depends on the average type. See the descriptions for the keys which select each Average Type (“[Log-Pwr Avg \(Video\)](#)” on page 1412 (Video), “[Pwr Avg \(RMS\)](#)” on page 1413 (RMS), or “[Voltage Avg](#)” on page 1413) for details on these equations.

See “More Information” on page 1411.

Key Path	Meas Setup
Remote Command	[:SENSe] :AVERAge :TYPE :AUTO OFF ON 0 1 [:SENSe] :AVERAge :TYPE :AUTO?
Preset	ON
State Saved	Saved in Instrument State
Readback line	1-of-N selection as Log-Pwr (Video) for Log-Pwr (Video) Avg Pwr (RMS) for Power Avg Voltagefor Voltage
Initial S/W Revision	Prior to A.02.00
Help Map ID	3205

Remote Command:	[:SENSe] :AVERAge :TYPE RMS LOG SCALAr [:SENSe] :AVERAge :TYPE?
Notes:	Parameters map to avg types as: RMS = Pwr (RMS) Avg LOG = Log-Pwr (Video) Avg SCALAr = Voltage Avg
Preset:	LOG
Backwards Compatibility SCPI:	[:SENSe] :AVERAge :TYPE LINear sets Scalar averaging [:SENSe] :AVERAge :TYPE VOLTage sets Scalar averaging [:SENSe] :AVERAge :TYPE VIDEo sets Log-Power averaging [:SENSe] :AVERAge :TYPE LPOWer sets Log-Power averaging [:SENSe] :AVERAge :TYPE POWEr sets RMS averaging
Initial S/W Revision:	Prior to A.02.00
Help Map ID:	3206

More Information

When you select log-power averaging, the measurement results are the average of the signal level in logarithmic units (decibels). When you select power average (RMS), all measured results are converted into power units before averaging and filtering operations, and converted back to decibels for displaying. Remember: there can be significant differences between the average of the log of power and the log of the average power.

These are the averaging processes within the test set and all of them are affected by this setting:

Common Measurement Functions 1

Trace averaging (see Section “[Trace Average](#)” on page 1786) averages signal amplitudes on a trace-to-trace basis. The average type applies to all traces in Trace Average (it is not set on a trace-by-trace basis).

Average detector (see Section “[Detector](#)” on page 1792) averages signal amplitudes during the time or frequency interval represented by a particular measurement point.

VBW filtering (see Section “[BW](#)” on page 1343) adds video filtering which is a form of averaging of the video signal.

When **Auto** is selected, the test set chooses the type of averaging (see below). When one of the average types is selected manually, the test set uses that type regardless of other test set settings, and shows Man on the **Average Type** key.

Auto

Chooses the optimum type of averaging for the current test set measurement settings.

Key Path	Meas setup, Average Type
Example	AVER:TYPE:AUTO ON
Notes	See Average Type , above
Couplings	Here are the auto-select rules for Average Type : Auto selects Voltage Averaging if the Detector for any active trace is EMI Average or QPD or RMS Average ; otherwise it selects Power (RMS) Averaging if a Marker Function (Marker Noise, Band/Intvl Power) is on, or Detector is set to Man and Average ; otherwise if Amplitude, Scale Type is set to Lin it selects Voltage Averaging ; otherwise, if the EMC Standard is set to CISPR, it selects Voltage; otherwise Auto selects Log-Power Average . Note that these rules are only applied to active traces. Traces which are not updating do not impact the auto-selection of Average Type.
State Saved	Saved in Instrument State
Readback	The type auto-selected is displayed in the readback line on the Average Type key
Initial S/W Revision	Prior to A.02.00
Help Map ID	3207

Log-Pwr Avg (Video)

Selects the logarithmic (decibel) scale for all filtering and averaging processes. This scale is sometimes called “Video” because it is the most common display and analysis scale for the video signal within the test set. This scale is excellent for finding CW signals near noise, but its response to noise-like signals is 2.506 dB lower than the average power of those noise signals. This is compensated for in the Marker Noise function.

The equation for trace averaging on the log-pwr scale is shown below, where K is the number of averages accumulated. (In continuous sweep mode, once K has reached the Average/Hold Number, K stays at that value, providing a continuous running average.)

$$\text{New avg} = ((K-1)\text{Old avg} + \text{New data})/K$$

Assumes all values in decibel scale.

Key Path	Meas setup, Average Type
Example	AVER:TYPE LOG
Notes	See “Average Type” on page 1410”
Couplings	See “Auto” on page 1412”
Readback	Log-Pwr (Video)
Initial S/W Revision	Prior to A.02.00
Help Map ID	3208

Pwr Avg (RMS)

In this average type, all filtering and averaging processes work on the power (the square of the magnitude) of the signal, instead of its log or envelope voltage. This scale is best for measuring the true time average power of complex signals. This scale is sometimes called RMS because the resulting voltage is proportional to the square root of the mean of the square of the voltage.

In the equation for averaging on this scale (below), K is the number of averages accumulated. (In continuous sweep mode, once K has reached the Average/Hold Number, K stays at that value, providing a running average.)

$$\text{New avg} = 10 \log ((1/K)((K-1)(10\text{Old avg}/10)+10\text{New data}/10))$$

Equation assumes all values are in the decibel scale.

Key Path	Meas setup, Average Type
Example	AVER:TYPE RMS
Notes	See “Average Type” on page 1410
Couplings	See “Auto” on page 1412
Readback	Pwr (RMS)
Initial S/W Revision	Prior to A.02.00
Help Map ID	3209

Voltage Avg

In this Average type, all filtering and averaging processes work on the voltage of the envelope of the signal. This scale is good for observing rise and fall behavior of AM or pulse-modulated signals such as radar and TDMA transmitters, but its response to noise-like signals is 1.049 dB lower than the average power of those noise signals. This is compensated for in the **Marker Noise** function.

In the equation for averaging on this scale (below), K is the number of averages accumulated. (In continuous sweep mode, once K has reached the Average/Hold Number, K stays at that value.)

$$\text{New avg} = 20 \log ((1/K)((K-1)(10\text{Old avg}/20)+10\text{New data}/20))$$

Common Measurement Functions 1

Equation assumes all values are in the decibel scale.

Key Path	Meas setup, Average Type
Example	AVER:TYPE SCAL
Notes	See “Average Type” on page 1410
Couplings	See “Auto” on page 1412
Readback	Pwr (RMS)
Initial S/W Revision	Prior to A.02.00
Help Map ID	3210

Limits

The limits key opens up a menu of keys to control the limits for the current measurement. Limits arrays can be entered by the user, sent over SCPI, or loaded from a file.

Initial S/W Revision	A.02.00
Key Path	Meas Setup
Dependencies	This key will only appear if you have the proper option installed in your test set.
Preset	Limits are turned off by a Preset, but the Limits arrays (data) are only reset (deleted) by Restore Mode Defaults. They survive shutdown and restarting of the test set application, which means they will survive a power cycle.
Help Map ID	3832

Select Limit

Specifies the selected limit. The term “selected limit” is used throughout this document to specify which limit is affected by the functions.

Key Path	Meas Setup, Limits
Notes	The selected limit is remembered even when not in the Limit Menu.
Preset	Limit 1, not affected by Mode Preset, preset by Restore Mode Defaults.
State Saved	Saved in State.
Initial S/W Revision	A.02.00
Help Map ID	3833

Limit On/Off

Selects whether the limit and margin are displayed. If Test Limits is on, this also determines whether the test trace (see [“Test Trace” on page 1416](#)) is tested against the limit. If **Limit On/Off** is **On**, the following occurs:

- The limit line is displayed, in the same color as the limited trace, but paler. Portions of traces which fail the limits are displayed in red.
- The margin line is displayed if Margin is on and the Margin Value is non-zero (see “Margin” on page 1421). The margin line is displayed in the same color as the limit line, but paler still and dashed. Portions of traces which pass the limits but fail the margin is displayed in amber.
- The trace is tested for the purpose of the “Trace Pass/Fail” indication in the graticule if, in addition to **Limit On/Off** being **On**, the trace is displayed and **Test Limits (All Limits)** is on (see “Test Limits” on page 1427). If the trace is not tested, no report of the trace passing or failing is seen on the graticule. Note that the SCPI queries of Limit Pass/Fail are independent of these conditions; the test is always performed when queried over SCPI.

The PASS/FAIL box in the corner of the Meas Bar is only displayed if there is at least one “Trace Pass/Fail” indication displayed in the graticule.

Note that the red and amber coloring of traces which fail the limits and/or margins only applies to traces whose X-axis corresponds to the current test set X-axis. Traces which are not updating (in View, for example) will not change color if the test set X-axis settings (for example, start and stop frequency) do not match those of the trace, for example if they have been changed since the trace stopped updating. In this case, the Invalid Data indicator (*) will appear in the upper right hand corner.

When the limits are frequency limits but the trace is a zero-span trace, the limit trace is drawn at the limit amplitude of the center frequency. When the limits are time limits but the trace is a frequency domain trace, the limit trace is drawn according to the current time axis, with the left of the screen being 0 and the right being equal to sweep time.

Key Path	Meas Setup, Limits
Remote Command	:CALCulate:LLINe [1] 2 3 4 5 6 :DISPlay OFF ON 0 1 :CALCulate:LLINe [1] 2 3 4 5 6 :DISPlay?
Example	:CALC:LLIN2:DISP ON turns on the display for limit line 2.
Dependencies	This command will generate an “Option not available” error unless you have the proper option installed in your test set.
Couplings	Limit display ON selects the limit. Testing is done on all displayed limits if Test Limits (All Limits) is ON. Entering the limit menu from the GUI turns on the selected limit.
Preset	OFF
State Saved	Saved in State.
Backwards Compatibility SCPI	:CALCulate:LLINe[1] 2:STATe OFF ON 0 1 (In the past you had to send the DISP command as well as the STATe command in order to get a limit on and testing. Now, the DISP command is sufficient, but we accept the state command and do nothing with it)
Initial S/W Revision	A.02.00
Help Map ID	3834

Common Measurement Functions 1

Properties

Accesses a menu which lets you set the properties of the selected limit.

Key Path	Meas Setup, Limits
Initial S/W Revision	A.02.00
Help Map ID	3835

Select Limit

Specifies the selected limit. The term “selected limit” is used throughout this document to specify which limit is affected by the functions.

Key Path	Meas Setup, Limits, Properties
Notes	The selected limit is remembered even when not in the Limit Menu.
Preset	Limit 1, not affected by Mode Preset, preset by Restore Mode Defaults.
State Saved	Saved in State.
Initial S/W Revision	A.02.00
Help Map ID	3836

Test Trace

Selects the trace you want the limit to test. A limit is applied to one and only one trace; each trace can have both an upper and a lower limit. When executing Limit Test, the limit is applied only to the specified trace.

A trace can have multiple limit lines simultaneously; in that case, only one upper and one lower limit line will affect the color of the trace. Other limit lines are displayed, and affect the pass/fail status, but the trace does not turn red if it crosses a secondary limit line.

Key Path	Meas Setup, Limits, Properties
Remote Command	:CALCulate:LLINe [1] 2 3 4 5 6 :TRACe 1 2 3 4 5 6 :CALCulate:LLINe [1] 2 3 4 5 6 :TRACe?
Example	:CALC:LLIN3:TRAC 2 applies limit 3 to trace 2.
Notes	When the trace display is off, the trace is not tested. The trace is tested only when the trace display is on and Test Limits (see “ Test Limits ” on page 1427) is on.
Couplings	This matters when testing a trace or limit line for failure, via :CALC:LLIN3:FAIL? or :CALC:TRAC2:FAIL?
Preset	Limits 1 and 2 preset to 1, Limits 3 and 4 preset to 2, Limits 5 and 6 preset to 3 Not affected by Mode Preset, preset by Restore Mode Defaults.
State Saved	Saved in State.
Min	1

Max	6
Readback	Trace 1 2 3 4 5 6
Initial S/W Revision	A.02.00
Help Map ID	3837

Type

Selects whether the limit you are editing is an upper or lower limit. An upper limit fails if the trace exceeds the limit. A lower limit fails if the trace falls below the limit.

Key Path	Meas Setup, Limits, Properties
Remote Command	:CALCulate:LLINe [1] 2 3 4 5 6 :TYPE UPPER LOWER :CALCulate:LLINe [1] 2 3 4 5 6 :TYPE?
Example	:CALC:LLIN2:TYPE LOW sets limit line 2 to act as a lower limit.
Couplings	If a margin has already been set for this limit line, and this key is used to change the limit type, then the margin value will reverse sign.
Preset	Upper for Line 1, 3, and 5; Lower for Line 2, 4, 6. Not affected by Mode Preset, preset by Restore Mode Defaults.
State Saved	Saved in State.
Initial S/W Revision	A.02.00
Help Map ID	3838

Interpolation

Accesses a menu which lets you set the frequency and amplitude interpolation of the selected limit.

Key Path	Meas Setup, Limits, Properties
Readback	[Lin Log Frequency, Lin Log Amplitude]
Initial S/W Revision	A.02.00
Help Map ID	3839

Frequency Interpolation

This key is grayed out if Time is the selected X-axis units. Sets the interpolation between frequency points, allowing you to determine how limit trace values are computed between points in a limit table. The available interpolation modes are linear and logarithmic. If frequency interpolation is logarithmic (Log), frequency values between limit points are computed by first taking the logarithm of both the table values and the intermediate value. A linear interpolation is then performed in this logarithmic frequency space. An exactly analogous manipulation is done for logarithmic amplitude interpolation.

Note that the native representation of amplitude is in dB.

For linear amplitude interpolation and linear frequency interpolation, the interpolation is computed as:

Common Measurement Functions 1

$$y = 20 \log \left(\frac{10^{\frac{y_{i+1}}{20}} - 10^{\frac{y_i}{20}}}{f_{i+1} - f_i} (f - f_i) + 10^{\frac{y_i}{20}} \right)$$

For linear amplitude interpolation and log frequency interpolation, the interpolation is computed as:

$$y = 20 \log \left(\frac{10^{\frac{y_{i+1}}{20}} - 10^{\frac{y_i}{20}}}{\log f_{i+1} - \log f_i} (\log f - \log f_i) + 10^{\frac{y_i}{20}} \right)$$

For log amplitude interpolation and linear frequency interpolation, the interpolation is computed as:

$$y = \frac{y_{i+1} - y_i}{f_{i+1} - f_i} (f - f_i) + y_i$$

For log amplitude interpolation and log frequency interpolation, the interpolation is computed as:

$$y = \frac{y_{i+1} - y_i}{\log f_{i+1} - \log f_i} (\log f - \log f_i) + y_i$$

NOTE Interpolation modes determine how limit values are computed between points in the limit table. The appearance of a limit trace is also affected by the amplitude scale, which may be linear or logarithmic.

Key Path	Meas Setup, Limits, Properties, Interpolation
Remote Command	:CALCulate:LLINE [1] 2 3 4 5 6 :CONTRol:INTerpolate:TYPE LOGarithmic LINear :CALCulate:LLINE [1] 2 3 4 5 6 :CONTRol:INTerpolate:TYPE?
Example	:CALC:LLIN:CONT:INT:TYPE LIN sets limit line 1 frequency interpolation to linear.
Preset	Linear, not affected by Mode Preset, preset by Restore Mode Defaults.
State Saved	Saved in instrument state.
Initial S/W Revision	A.02.00
Help Map ID	3840

Amplitude Interpolation

Sets the interpolation to linear or logarithmic for the specified limiting points set, allowing you to determine how limit trace values are computed between points in a limit table. See Frequency Interpolation for the equations used to calculate limit values between points.

Key Path	Meas Setup, Limits, Properties, Interpolation
----------	---

Remote Command	:CALCulate:LLINE [1] 2 3 4 5 6:AMPLitude:INTerpolate:TYPE LOGarithmic LINEar :CALCulate:LLINE [1] 2 3 4 5 6:AMPLitude:INTerpolate:TYPE?
Example	:CALC:LLIN:AMPL:INT:TYPE LIN sets limit line 1 amplitude interpolation to linear.
Preset	Logarithmic, not affected by Mode Preset, preset by Restore Mode Defaults.
State Saved	Saved in instrument state.
Initial S/W Revision	A.02.00
Help Map ID	3841

Fixed / Relative

Opens a menu which will allow you to specify that the selected limit is relative to either Center Frequency or Reference level.

Key Path	Meas Setup, Limits, Properties
Readback	Fixed Rel to CF Rel to RL Rel to CF + RL (square brackets)
Initial S/W Revision	A.02.00
Help Map ID	3842

Relative to CF

Chooses whether the limit line frequency points are coupled to the test set center frequency, and whether the frequency points are expressed as an offset from the test set center frequency. If the limit lines are specified with time, this has no effect. The limit table must in this case support negative frequencies.

For example, assume you have a frequency limit line, and the test set center frequency is at 1 GHz. If Relative to CF is “Off”, entering a limit line segment with a frequency coordinate of 300 MHz displays the limit line segment at 300 MHz, and the limit line segment will not change frequency if the center frequency changes. If Relative to CF is “On”, entering a limit line segment with a frequency coordinate of 300 MHz displays the limit line segment at CF + 300 MHz, or 1.3 GHz. Furthermore, if the center frequency changes to 2 GHz, the limit line segment is displayed at CF + 300 MHz, or 2.3 GHz.

It is possible to change this setting after a limit line has been entered. When changing from On to Off or vice-versa, the frequency values in the limit line table change so that the limit line remains in the same position for the current frequency settings of the test set.

Pressing this button makes Center Frequency the active function.

Key Path	Meas Setup, Limits, Properties, Fixed/Relative
Remote Command	:CALCulate:LLINE [1] 2 3 4 5 6:FREQUENCY:CMODE:RELative ON OFF 1 0 :CALCulate:LLINE [1] 2 3 4 5 6:FREQUENCY:CMODE:RELative?
Example	:CALC:LLIN:FREQ:CMOD:REL ON makes limit line 1 relative to the center frequency.

Common Measurement Functions 1

Notes	If the Trace Domain is changed to Time (:CALCulate:LLINE:CONTRol:DOMain TIME), the SCPI command :CALCulate:LLIne[1] 2 3 4 5 6:FREQuency:CMODE:RELative ON OFF 1 0 will have no effect.
Couplings	Pressing this button makes Center Frequency the active function.
Preset	Off, not affected by Mode Preset, preset by Restore Mode Defaults.
State Saved	Saved in instrument state.
Initial S/W Revision	A.02.00
Help Map ID	3843

Relative to RL

Chooses whether the limit line amplitude points are coupled to the test set reference level, and whether the amplitude points are expressed as an offset from the test set reference level.

For example, assume you have a limit line, and the reference level at -10 dBm. If Relative to RL is “Off”, entering a limit line segment with an amplitude coordinate of -20 dB displays the limit line segment at -20 dBm, and the limit line segment will not change amplitude if the reference level amplitude changes. If Relative to RL is “On”, entering a limit line segment with an amplitude coordinate of -20 dB displays the limit line segment at RL -20 dB, or -30 dBm. Furthermore, if the reference level amplitude changes to -30 dBm, the limit line segment is displayed at RL -20 dB, or -50 dBm.

It is possible to change this setting after a limit line has been entered. When changing from On to Off or vice-versa, the amplitude values in the limit line table change so that the limit line remains in the same position for the current reference level settings of the test set.

Key Path	Meas Setup, Limits, Properties, Fixed/Relative
Remote Command	:CALCulate:LLINe [1] 2 3 4 5 6 :AMPLitude:CMODE:RELative ON OFF 1 0 :CALCulate:LLINe [1] 2 3 4 5 6 :AMPLitude:CMODE:RELative?
Example	:CALC:LLIN:AMPL:CMOD:REL ON makes limit line 1 relative to the reference level amplitude.
Couplings	Pressing this button makes Reference level the active function.
Preset	Off, not affected by Mode Preset, preset by Restore Mode Defaults.
State Saved	Saved in instrument state.
Initial S/W Revision	A.02.00
Help Map ID	3844

Description

Provides a description of up to 60 characters by which the operator can easily identify the limit. It is stored in the exported file. Can be displayed in the active function area by selecting as the active function, if desired to be in a

screen dump.

Key Path	Meas Setup, Limits, Properties
Remote Command	:CALCulate:LLINE [1] 2 3 4 5 6:DESCription "Description" :CALCulate:LLINE [1] 2 3 4 5 6:DESCription?
Example	:CALC:LLIN:DESC "European Emissions"
Preset	"" (null String), not affected by Mode Preset, preset by Restore Mode Defaults.
State Saved	Saved in instrument state
Readback	As much of the description will fit on one line of the key, followed by "..." if some of the description will not fit on one line of the key.
Initial S/W Revision	A.02.00
Help Map ID	3845

Comment

Sets an ASCII comment field which is stored in an exported file. Can be displayed in the active function area by selecting as the active function, if desired to be in a screen dump. The Limits .csv file supports this field.

Key Path	Meas Setup, Limits, Properties
Remote Command	:CALCulate:LLINE [1] 2 3 4 5 6:COMMENT "text" :CALCulate:LLINE [1] 2 3 4 5 6:COMMENT?
Example	:CALC:LLIN1:COMM "this is a comment"
Preset	"" (null String), not affected by Mode Preset, preset by Restore Mode Defaults.
State Saved	Saved in instrument state.
Readback	As much of the description will fit on one line of the key, followed by "..." if some of the description will not fit on one line of the key.
Initial S/W Revision	A.02.00
Help Map ID	3846

Margin

Selects a margin for this limit, which will cause a trace to Fail Margin when the trace is between the limit line and the margin line. Portions of the traces which pass the limit but fail the margin are displayed in an amber color.

A margin is always specified in dB relative to a limit – an upper limit always has a negative margin, and a lower limit always has a positive margin. If a value is entered with the incorrect sign, the system automatically takes the negative of the entered value.

If the limit type is switched from lower to upper while margin is present, the margin reverses sign.

Common Measurement Functions 1

When the Margin is selected, it may be turned off by pressing the Margin key until Off is underlined. This may also be done by performing a preset. Margin is the default active function whenever the margin is on, and it is not the active function whenever the margin is off.

The margin lines are displayed in the same color as limit lines, but paler. If the limited trace is blanked then the limit line and the margin line is blanked as well.

Key Path	Meas Setup, Limits
Remote Command	:CALCulate:LLINe [1] 2 3 4 5 6 :MARGin <rel_amp1> :CALCulate:LLINe [1] 2 3 4 5 6 :MARGin? :CALCulate:LLINe [1] 2 3 4 5 6 :MARGin:STATe OFF ON 0 1 :CALCulate:LLINe [1] 2 3 4 5 6 :MARGin:STATe?
Example	:CALC:LLIN1:MARG -2dB sets limit line 1's margin to -2 dB (Limit Line 1 is by default an upper limit). :CALC:LLIN2:MARG 1dB sets limit line 2's margin to 1 dB (Limit Line 2 is by default a lower limit). :CALC:LLIN2:MARG:STAT OFF turns off the margin for limit line 2 and removes any tests associated with that margin line.
Notes	The queries "Limit Line Fail?" (:CALCulate:LLINe[1] 2 3 4 5 6:FAIL?) and "Trace Fail?" (:CALCulate:TRACe[1] 2 3 4 5 6:FAIL?) will return 1 if the margin fails.
Couplings	This will affect :CALC:LLIN3:FAIL or :CALC:TRAC2:FAIL?
Preset	not affected by Mode Preset, set to 0 dB for all Limits by Restore Mode Defaults.
State Saved	Saved in instrument state.
Min	-40 dB (Upper); 0 dB (Lower)
Max	0 dB (Upper); 40 dB (Lower);
Default Unit	dB
Initial S/W Revision	A.02.00
Help Map ID	3847

Edit

Opens the Table Editor for the selected limit line.

When entering the menu, the editor window (with the limit table) turns on, the selected Limit is turned **On** and the amplitude scale is set to **Log**. The display of the trace to which the selected limit applies is turned on (thus, traces in Blank are set to View and traces in Background are set to On). Turning on the Limit means it's display is on, and it's testing mode is on as well; you should turn off any other limits that are on if they interfere with the editing of the selected limit.

NOTE The table editor will only operate properly if the test set is sweeping, because its

updates are tied to the sweep system. Thus, you should not try to use the editor in single sweep, and it will be slow during computer-intensive operations like narrow-span FFT sweeps.

When exiting the edit menu (by using the Return key or by pressing a test set front panel key), the editor window turns off, however the Limit is still on and displayed, and the amplitude scale remains **Log**.

Limits are turned off by a Preset, but the Limits arrays (data) are only reset (deleted) by Restore Mode Defaults. They survive shutdown and restarting of the test set application, which means they will survive a power cycle.

Key Path	Meas Setup, Limits
Couplings	Turns the Limit Peaks table off. A remote user can enter or access limit line data via :CALCulate:LLINe[1] 2 3 4 5 6:DATA
Initial S/W Revision	A.02.00
Help Map ID	3848

Navigate

Lets you move through the table to edit the desired point

Key Path	Meas Setup, Limits, Edit
Notes	There is no value readback on the key
Initial S/W Revision	A.02.00
Help Map ID	3849

Frequency

Lets you edit the frequency of the current row.

Key Path	Meas Setup, Limits, Edit
Notes	There is no value readback on the key
Initial S/W Revision	A.02.00
Help Map ID	3850

Amplitude

Lets you edit the Amplitude of the current row.

Key Path	Meas Setup, Limits, Edit
Notes	There is no value readback on the key
Min	-1000 dBm

Common Measurement Functions 1

Max	1000 dBm
Initial S/W Revision	A.02.00
Help Map ID	3851

Insert Point Below

Pressing this key inserts a point below the current point. The new point is a copy of the current point and becomes the current point. The new point is not yet entered into the underlying table, and the data in the row is displayed in light gray.

Key Path	Meas Setup, Limits, Edit
Initial S/W Revision	A.02.00
Help Map ID	3852

Delete Point

This is an immediate action key. It will immediately delete the currently-selected point, whether or not that point is being edited, and select Navigate. The point following the currently-selected point (or the point preceding if there is none) is selected.

Key Path	Meas Setup, Limits, Edit
Initial S/W Revision	A.02.00
Help Map ID	3853

Copy from Limit

Copies an existing limit into the current limit, including all secondary parameters (Description, Associated Trace, Type, Margin, Interpolation, Relative to CF/RL).

Remote Command:	:CALCulate:LLINE [1] 2 3 4 5 6 :COPY LLINE1 LLINE2 LLINE3 LLINE4 LLINE5 LLINE6
Example:	:CALC:LLINE2:COPY LLINE1 copies the data from line 1 into line 2.
Notes:	Auto return to the Edit menu.
Initial S/W Revision:	A.02.00
Help Map ID:	3874

Build from Trace

Builds a limit using an existing trace. This command will overwrite all data in the limit. Since a straight copy would typically have hundreds or thousands of segments, the data is approximated to better represent a limit line; small excursions whose width is less than 10 trace buckets will sometimes not be captured. Secondary parameters which are not associated with traces (Description, Associated Trace, Type, Margin, Interpolation, Relative to CF/RL) are unchanged.

When taking a trace in order to build a limit, it will often work well to take the trace with a resolution bandwidth wider than the expected measurement, a video bandwidth lower than the expected measurement, and with the

detector set to Max Hold or Min Hold.

Note that an upper limit is built above the trace, while a lower limit is built below the trace. If the trace is constant, the limit should pass after being built.

Remote Command:	:CALCulate:LLINE [1] 2 3 4 5 6 :BUILd TRACE1 TRACE2 TRACE3 TRACE4 TRACE5 TRACE6
Example:	:CALC:LLIN2:BUIL TRACE1 builds limit line 2 based on the data in trace 1. This will overwrite the data in the table editor.
Notes:	Auto return to Edit menu.
Initial S/W Revision:	A.02.00
Help Map ID:	3873

Offset

Enters a menu which allows you to offset the limit trace by a specified frequency, time, or amplitude. The offsets are immediately applied to the limit trace for display and failure calculation; the offset can also be applied to the points in the limit line.

Key Path	Meas Setup, Limits, Edit
Initial S/W Revision	A.02.00
Help Map ID	3870

X Offset

Offsets the limit trace by some specified frequency (for Frequency-based limit lines) or a time (for time-based limit lines).

Key Path	Meas Setup, Limits, Edit, Offset
Remote Command	:CALCulate:LLINE [1] 2 3 4 5 6 :OFFSet:X <value> :CALCulate:LLINE [1] 2 3 4 5 6 :OFFSet:X? <value> = <freq> if Limit X-Axis Unit is Frequency, <value> = <time> if Limit X-Axis Unit is Time
Example	:CALC:LLIN:OFFS:X -50MHZ sets the X axis offset to -50 MHz. :CALC:LLIN:OFFS:UPD will apply the X axis offset to all points in the limit line, then reset the X axis offset to zero.
Preset	0 Hz if Limit X-Axis Unit is Frequency 0 S if Limit X-Axis Unit is Time
State Saved	Saved in State, survives Preset
Min	-500 GHz
Max	500 GHz
Default Unit	Determined by X axis scale.

Common Measurement Functions 1

Initial S/W Revision	A.02.00
Help Map ID	3871

Y Offset

Offsets all segments in the limit line by some specified amplitude.

Key Path	Meas Setup, Limits, Edit, Offset
Remote Command	:CALCulate:LLINe [1] 2 3 4 5 6 :OFFSet:Y <rel ampl> :CALCulate:LLINe [1] 2 3 4 5 6 :OFFSet:Y?
Example	:CALC:LLIN:OFFS:Y -3 dB sets the Y axis offset to -3 dB. :CALC:LLIN:OFFSet:UPD will apply the Y axis offset to all points in the limit line, then reset the Y axis offset to zero.
Preset	0 dB
State Saved	Saved in instrument state.
Min	-Infinity
Max	+Infinity
Default Unit	dB
Initial S/W Revision	A.02.00
Help Map ID	3872

Apply Offsets to Limit Table

Adds the X and Y offsets to each point in the limit table, then resets the X and Y offset values to zero. This has no effect on the position of the limit trace.

For example, if the X offset is -10 MHz and the Y offset is 1 dB, the values in the limit table are updated as follows: 10 MHz is subtracted from each X value, 1 dB is added to each Y value. The offset values are then reset to zero. The limit trace is not moved and the limit table is updated to accurately reflect the currently-displayed limit trace.

Key Path	Meas Setup, Limits, Edit, Offset
Remote Command	:CALCulate:LLINe [1] 2 3 4 5 6 :OFFSet:UPDate
Example	:CALC:LLIN:OFFS:UPD sets updates the limit table to reflect the X and Y offsets, then resets the offsets to zero.
State Saved	No state
Initial S/W Revision	A.02.00
Help Map ID	3866

Scale X Axis

Matches the X-axis to the selected Limit, as well as possible.

For frequency limits and a frequency-domain X-axis, sets the Start and Stop Frequency to contain the minimum and maximum Frequency of the selected Limit. The range between Start Frequency and Stop Frequency is 12.5% above the range between the minimum and maximum Frequency so that span exceeds this range by one graticule division on either side.

For time limits and a time-domain X-axis, sets the sweep time to match the maximum Time of the selected Limit.

If the domain of the selected limit does not match the domain of the X-axis, no action is taken. Standard clipping rules apply, if the value in the table is outside the allowable range for the X axis.

Key Path	Meas Setup, Limits, Edit
Initial S/W Revision	A.02.00
Help Map ID	3867

Delete Limit

Deletes the currently selected limit line. Pressing Delete Limit purges the data from the limit line tables.

Limit data – including secondary parameters such as description, margin value, et cetera - are cleared and returned to factory preset settings.

When this key is pressed a prompt is placed on the screen that says “Please press Enter or OK key to delete limit. Press ESC or Cancel to close this dialog.” The deletion is only performed if you press OK or Enter; if so, after the deletion, the informational message “Limit deleted” appears in the MSG line.

Key Path	Meas Setup, Limits
Remote Command	:CALCulate:LLINe [1] 2 3 4 5 6 :DELete
Example	:CALC:LLIN2:DEL deletes all data for limit line 2.
Initial S/W Revision	A.02.00
Help Map ID	3854

Test Limits

Selects whether displayed traces are tested against displayed limits (i.e. those for which Limit On/Off is set to On).

For each displayed trace for which a Limit is turned on, a message is displayed in the upper-left corner of the graticule to notify whether the trace passes or fails the limits.

If the trace is at or within the bounds of all applicable limits and margins, the text “Trace x Pass” is displayed in green, where x is the trace number. A separate line is used for each reported trace.

If the trace is at or within the bounds of all applicable limits, but outside the bounds of some applicable margin, the text “Trace x Fail Margin” is displayed in amber, where x is the trace number. A separate line is used for each reported trace.

If the trace is outside the bounds of some applicable limits, the text “Trace x Fail” is displayed in red, where x is the trace number. A separate line is used for each reported trace.

If the trace has no enabled limits, or the trace itself is not displayed, no message is displayed for that trace.

Common Measurement Functions 1

The PASS/FAIL box in the corner of the Meas Bar is only displayed if there is at least one “Trace Pass/Fail” indication displayed in the graticule.

If two amplitude values are entered for the same frequency, a single vertical line is the result. In this case, if an upper line is chosen, the lesser amplitude is tested. If a lower line is chosen, the greater amplitude is tested.

This command only affects the display, and has no impact on remote behavior. Limit queries over SCPI test the trace against the limit regardless of whether the trace or the limit is turned on (exception: the query `:CALCulate:TRACe[1]|2|3|4|5|6:FAIL?` tests only the limits that are turned on for that trace).

Key Path	Meas Setup, Limits
Remote Command	<code>:CALCulate:LLINe:TEST OFF ON 0 1</code> <code>:CALCulate:LLINe:TEST?</code>
Example	<code>:CALC:LLIN:TEST ON</code> turns on testing, and displays the results in the upper left corner.
Preset	On, not affected by Mode Preset, preset by Restore Mode Defaults.
State Saved	Saved in instrument state.
Initial S/W Revision	A.02.00
Help Map ID	3855

X-Axis Unit

Selects how the limit-line segments are defined. Pressing X-axis unit selects whether the limit lines are entered using frequency (Freq) or sweep time (Time) to define the segments. They can be specified as a table of limit-line segments of amplitude versus frequency, or of amplitude versus time. When the X-Axis Unit is set to Time, a time value of zero corresponds to the start of the sweep, which is at the left edge of the graticule, and the column and key in the Limit Table Editor will read Time instead of Frequency

Switching the limit-line definition between Freq and Time will erase all of the current limit lines. When you do this from the front panel, a warning dialog will pop up letting you know that you are about to erase all the limit lines, and prompting you to hit “OK” if you are sure.

Changing the X-axis unit will erase all your limit lines. Are you sure you want to do this? Press **Enter** or **OK** to proceed, or **Cancel (Esc)** to cancel.

Key Path	Meas Setup, Limits
Remote Command	<code>:CALCulate:LLINe:CONTRol:DOMain FREQuency TIME</code> <code>:CALCulate:LLINe:CONTRol:DOMain?</code>
Example	<code>:CALC:LLIN:CONT:DOM FREQ</code> deletes all currently existing limit lines, then sets all limit lines to be specified in terms of frequency.
Couplings	This affects all limit lines simultaneously, and resets all limit line data except the .wav file and email address stored in the Actions.
Preset	Freq, not affected by Mode Preset, preset by Restore Mode Defaults.

State Saved	Saved in instrument state.
Initial S/W Revision	A.02.00
Help Map ID	3856

Delete All Limits

Deletes all limit lines. Pressing Delete All Limits purges the data from all limit line tables.

All limit data are cleared and returned to factory preset settings.

When this key is pressed a prompt is placed on the screen that says “Please press Enter or OK key to delete all limits. Press ESC or Cancel to close this dialog.” The deletion is only performed if you press OK or Enter; if so, after the deletion, the informational message “All Limits deleted” appears in the MSG line.

Key Path	Meas Setup, Limits
Remote Command	:CALCulate:LLINe:ALL:DELeTe
Example	:CALC:LLIN:ALL:DEL deletes all data for all limit lines.
Initial S/W Revision	A.02.00
Help Map ID	3857

Limit Line Data (Remote Command Only, Backwards Compatibility)

Defines the limit line values, and destroys all existing data. Up to 200 points may be defined for each limit using the following parameters.

<x>Frequency or time values as specified by :Calculate:LLINe:CONTRol:DOMain. Units default to Hz (for frequency) and seconds (for time).

Range: -30 Gs to +30 Gs for time limits, -3 kHz to +350 GHz for frequency limits.

<ampl>Amplitude values units default to dBm. Up to two amplitude values can be provided for each x-axis value, by repeating <x-axis> in the data list.

Range: -1000 dBm to +1000 dBm

<connect> connect values are either "0" or "1." A "1" means this point is connected to the previously defined point to define the limit line. A "0" means that it is a point of discontinuity and is not connected to the preceding point. The connect value is ignored for the first point.

Remote Command:	:CALCulate:LLINe [1] 2 3 4 5 6 :DATA <x>, <ampl>, <connect> :CALCulate:LLINe [1] 2 3 4 5 6 :DATA?
Example:	:CALC:LLIN3:DATA 1E9,-20,0,2E9,-20,1,2E9,-10,1,3E9,-10,1 describes a stair-stepped limit line.

Common Measurement Functions 1

Preset:	Limit line data is cleared by Restore Mode Defaults. However, it survives shutdown/restart of the test set application (including power cycle)
State Saved:	Saved in instrument state.
Initial S/W Revision:	A.02.00
Help Map ID:	0

Limit Line Fail? (Remote Command Only)

Tests a limit line against its associated trace. Returns a 0 if the trace is within the limit and margin, a 1 if the trace exceeds either the limit or the margin.

Note that this command only tests one limit line – other limit lines are not tested when executing this command. To see whether a trace passed all limits, use :CALCulate:TRACe:FAIL?.

Note this command performs the test regardless of whether the trace or the limit is turned on on the display.

Remote Command:	:CALCulate:LLINe [1] 2 3 4 5 6 :FAIL?
Example:	:CALC:LLIN:FAIL? returns a zero if limit line 1's associated trace has no failure, 1 if there is a margin or limit failure.
Initial S/W Revision:	A.02.00
Help Map ID:	0

Limit State (Remote Command Only, SCPI standard compatibility)

Sets or queries whether the limit line is tested. This command is identical to :CALC:LLIN[1]|2|3|4|5|6:DISP.

Remote Command:	:CALCulate:LIMit [1] 2 3 4 5 6 :STATe ON OFF 0 1 :CALCulate:LIMit [1] 2 3 4 5 6 :STATe?
Example:	:CALC:LIM:STAT ON turns on limit line 1
Couplings:	This command is identical to :CALC:LLIN:DISP Testing is done on all displayed limits if "Test All Limits" is ON.
Preset:	Off (all limits)
State Saved:	Saved in State.
Initial S/W Revision:	A.02.00
Help Map ID:	0

Limit Line Control (Remote Command Only, SCPI standard compatibility)

Defines a list of limit line control (frequency or time) values for a given limit line. Up to 2000 points may be defined for each limit using the following parameters.

<x>Frequency or time values as specified by :CALCulate:LLINE:CONTRol:DOMain. Units default to Hz (for frequency) and seconds (for time).

Range: -30 Gs to +30 Gs for time limits, -3 kHz to +1200 GHz for frequency limits.

Note that X values may be repeated if a vertical step in the limit line is desired.

The points query returns the number of points in the control. It should match the number of points in the amplitude, that is, the number of values for the CONTRol axis and for the corresponding UPPER and/or LOWER limit lines must be identical. If one array is larger than the other, the limit trace is built using only as much data as is contained in the smaller array.

An empty array returns not a number (9.91e+37 to a data query), 0 to a POINTs query.

Remote Command:	:CALCulate:LIMit [1] 2 3 4 5 6 :CONTRol [:DATA] <x>, <x>, ... :CALCulate:LIMit [1] 2 3 4 5 6 :CONTRol [:DATA] ?
Example:	:CALC:LIM:CONT 1GHz,2GHz,2GHz,3GHz describes the X values of a stair-stepped limit line.
Preset:	Limit line data is cleared by Restore Mode Defaults.
State Saved:	Saved in instrument state.
Initial S/W Revision:	A.02.00
Help Map ID:	0

Remote Command:	:CALCulate:LIMit [1] 2 3 4 5 6 :CONTRol :POINTs?
Example:	:CALC:LIM:CONT:POIN? returns the number of points in the limit line.
Preset:	Limit line data is cleared by Restore Mode Defaults.
State Saved:	Saved in instrument state.
Initial S/W Revision:	A.02.00
Help Map ID:	0

Limit Line Upper / Lower (Remote Command Only, SCPI standard compatibility)

Defines a list of amplitude values for a given limit line. Changing the number of elements in the list spectrum will automatically turn the limit line off. Using the “UPP” syntax defines an upper limit line, using the “LOW” syntax defines a lower limit line. Note that a line may not be simultaneously both upper and lower; the type of the limit line will automatically be changed as appropriate. Up to 200 points may be defined for each limit using the following parameters.

<ampl>Amplitude values units default to dBm.

Range: -200 dBm to +100 dBm

The points query returns the number of points in the amplitude list. It will not be possible to turn on the limit line unless the number of points in the control matches the number of points in the amplitude.

The points query returns the number of points in the amplitude list. It should match the number of points

Common Measurement Functions 1

in the control, that is, the number of values for the CONTROL axis and for the corresponding UPPER and/or LOWER limit lines must be identical. If one array is larger than the other, the limit trace is built using only as much data as is contained in the smaller array.

An empty array returns the system error “list is empty” to a data query, 0 to a POINTs query.

Remote Command:	:CALCulate:LIMit [1] 2 3 4 5 6 :UPPer [:DATA] <ampl>, <ampl>, ... :CALCulate:LIMit [1] 2 3 4 5 6 :UPPer [:DATA] ?
Example:	:CALC:LIM:UPP -10, -10, -20, -20 describes the amplitude values of an upper limit line
Preset:	Limit line data is cleared by Restore Mode Defaults.
State Saved:	Saved in instrument state.
Initial S/W Revision:	A.02.00
Help Map ID:	0

Remote Command:	:CALCulate:LIMit [1] 2 3 4 5 6 :UPPer :POINTs?
Example:	:CALC:LIM:UPP:POIN? returns the number of points in the upper limit line.
Preset:	Upper Limit line data/points is cleared by Restore Mode Defaults.
State Saved:	Saved in instrument state.
Initial S/W Revision:	A.02.00
Help Map ID:	0

Remote Command:	:CALCulate:LIMit [1] 2 3 4 5 6 :LOWer [:DATA] <ampl>, ... :CALCulate:LIMit [1] 2 3 4 5 6 :LOWer [:DATA] ?
Example:	:CALC:LIM:LOW -10, -10, -20, -20 describes the amplitude values of a lower limit line
Preset:	Limit line data is cleared by Restore Mode Defaults.
State Saved:	Saved in instrument state.
Initial S/W Revision:	A.02.00
Help Map ID:	0

Remote Command:	:CALCulate:LIMit [1] 2 3 4 5 6 :LOWer :POINTs?
Example:	:CALC:LIM:UPP:POIN? returns the number of points in the lower limit line.
Preset:	Limit line data/points is cleared by Restore Mode Defaults.
State Saved:	Saved in instrument state.
Initial S/W Revision:	A.02.00

Help Map ID:	0
--------------	---

Limit Fail? (Remote Command Only, SCPI standard Compatibility)

Tests a limit line against its associated trace. Returns a 0 if the trace is within the limit and margin, a 1 if the trace exceeds either the limit or the margin. This command is identical to “:CALC:LLIN:FAIL?”

Note that this command only tests one limit line – other limit lines are not tested when executing this command. To see whether a trace passed all limits, use :CALCulate:TRACe:FAIL?.

Note this command performs the test regardless of whether the trace or the limit is turned on on the display.

Remote Command:	:CALCulate:LIMit [1] 2 3 4 5 6 : FAIL?
Example:	:CALC:LIM:FAIL? returns a zero if limit line 1’s associated trace has no failure, 1 if there is a margin or limit failure.
Couplings:	This command is identical to :CALC:LLIN:FAIL?
Initial S/W Revision:	A.02.00
Help Map ID:	0

Limit Clear (Remote Command Only, SCPI standard Compatibility)

Clears a limit line, and all associated data. This command is identical to “:CALC:LLIN:DEL”

Remote Command:	:CALCulate:LIMit [1] 2 3 4 5 6 : CLear
Example:	:CALC:LIM2:CLE deletes all data for limit line 2.
Couplings:	This command is identical to :CALC:LLIN:DEL
Initial S/W Revision:	A.02.00
Help Map ID:	0

Trace Fail? (Remote Command Only)

Tests a trace against all associated limit lines. Returns a 0 if the trace is within all limits and margins, a 1 if the trace exceed either the limit or the margin. If no limits apply to the selected trace, this will automatically return a 0.

Only applies to limits that are turned on, if a Limit is off it will not be tested. If a Trace is not displaying it will still be tested, and if **Test Limits (All Limits)** is off the Trace will still be tested.

This command ignores limit lines that are assigned to other traces.

Remote Command:	:CALCulate:TRACe [1] 2 3 4 5 6 : FAIL?
Example:	:CALC:TRAC3:FAIL? returns a zero if there is no failure, 1 if the trace exceeds either the limit or the margin.
Initial S/W Revision:	A.02.00

Common Measurement Functions 1

Help Map ID:	0
--------------	---

Fixed / Relative Limit (Remote Command Only, Backwards Compatibility)

This command sets both Relative to CF and Relative to RL simultaneously for all limits. If queried, it returns whether Limit Line 1 is set Relative to CF, and ignores all other fixed/relative data.

Remote Command:	:CALCulate:LLINe:CMODE FIXed RELative :CALCulate:LLINe:CMODE?
Example:	:CALC:LLIN:CMOD REL makes all limit lines relative to the center frequency and reference level.
Notes:	<p>This SCPI command is only supported for Backwards Compatibility.</p> <p>On the X-Series, this functionality is provided by a key which is specific to each limit line, and which provides a sub-menu with 2 keys (Relative to CF / Relative to RL).</p> <p>In order to be consistent with the implementation of the following new commands:</p> <pre>:CALCulate:LLINe[1] 2 3 4 5 6:FREQuency:CMODE:RELative ON OFF 1 0</pre> <pre>:CALCulate:LLINe[1] 2 3 4 5 6:FREQuency:CMODE:RELative?</pre> <p>and</p> <pre>:CALCulate:LLINe[1] 2 3 4 5 6:AMPLitude:CMODE:RELative ON OFF 1 0</pre> <pre>:CALCulate:LLINe[1] 2 3 4 5 6:AMPLitude:CMODE:RELative?</pre> <p>The :CALCulate:LLINe:CMODE? Query will returns 1 if Limit Line 1 is set Relative to CF, and returns 0 otherwise.</p>
Preset:	Fixed
Initial S/W Revision:	A.02.00
Help Map ID:	0

Merge Limit Line Data

Adds the points with the specified values to the current limit line, allowing you to merge limit line data. Up to two amplitude values are allowed for each X value. If more than 200 points are entered to be merged, the first 200 points are merged, then an error 'too many DATA entries' is reported.

Remote Command:	:CALCulate:LLINe [1] 2 3 4 5 6 :DATA:MERGe <x-axis>, <ampl>, <connected>
Example:	:CALC:LLIN1:DATA:MERG 1000000000,-20,0,2000000000,-30,1 merges the 10 GHz segment and the 20 GHz segment into limit line 1. Note that the 20 GHz segment is connected to the next lower point, which may or may not be the 10 GHz point.
Notes:	This SCPI command is only supported for Backwards Compatibility.
Preset:	Fixed

Initial S/W Revision:	A.02.00
Help Map ID:	0

N dB Points

Turns N dB points on and off and allows you to set the N dB value. N dB uses the selected marker. If the selected marker is not on when N dB is turned on, the selected marker turns on, as a Normal marker, at center screen, and is used by N dB.

See “N dB Points Results Query” on page 1436.

See “More Information” on page 1436.

Key Path	Meas Setup
Remote Command	:CALCulate:BWIDth BANDwidth:NDB <rel_ampl> :CALCulate:BWIDth BANDwidth:NDB? :CALCulate:BWIDth BANDwidth[:STATe] OFF ON 0 1 :CALCulate:BWIDth BANDwidth[:STATe] ?
Notes	If the selected marker is turned Off it turns off N dB Points. N DB Points is unaffected by Auto Couple
Preset	Off, 3.01 dB OFF
Preset	Off, 3.01 dB OFF
State Saved	The on/off status and the offset value are both saved in instrument state.
Min	-140 dB
Max	-0.01 dB
Initial S/W Revision	Prior to A.02.00
Help Map ID	3211

Common Measurement Functions 1

N dB Points Results Query

Remote Command:	:CALCulate:BWIDth BANDwidth:RESult?
Example:	:CALC:MARK:AOFF set selected marker to 1 :CALC:MARK:MAX put marker 1 on peak :CALC:BWID ON turn on N dB for the selected marker (1) :CALC:BWID:NDB-3.01 set the offset to -3.01 dB :CALC:BWID:RES? Query the result
Notes:	-100 returned if invalid reading
Initial S/W Revision:	Prior to A.02.00
Help Map ID:	3212

More Information

A marker should be placed on the peak of interest before turning on N dB points. The N dB points function looks for the two points on the marker's trace closest to the marker's X-axis value that are N dB below the marker's amplitude, one above and the other below the marker's X-axis value. (That is, one point is to the right and one is to the left of the selected marker.) The selected N dB value is called the offset. The function reports the frequency difference (for frequency domain traces) or time difference (for time domain traces) between those two points.

Each point is identified by a horizontal arrow pointing towards the marker, next to the trace. The arrows used by the N dB Points function is as shown in the figure below (where each square represents one pixel). They point in, horizontally, at the trace below a peak, on either side of its skirts. There is one pixel between the arrow and the trace

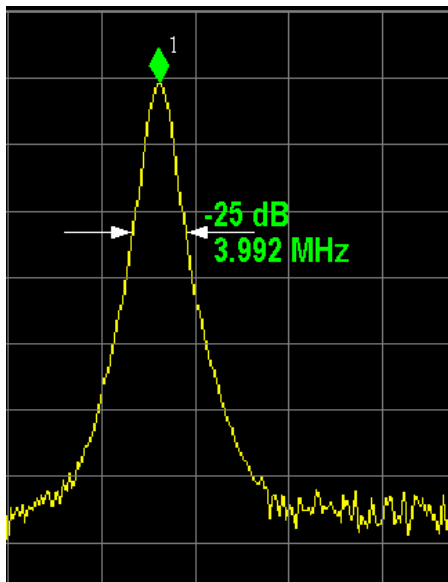

N dB Points can be used to measure the bandwidth of a signal; it is commonly used in conjunction with a tracking generator to measure filter bandwidths.

In one of the common use cases, the marker is placed on a peak, and the arrows are displayed N dB down the skirt from the marker on either side of the peak. The N dB value and the frequency difference between the two arrows is displayed around the arrow as shown in the figure above. Normally this displays on the right hand arrow, but if this would place any part of the text off screen to the right then it displays on the left arrow.

If the test set is unable to find data that is N dB below the marker on either side of the marker, the arrows are displayed at the indicator point of the marker, no value (---) is displayed as the result and -100 Hz returned remotely (see figure below):



Some sample N dB scenarios are shown below, to illustrate how the function works in various cases. In each case, the two-headed blue arrow represents N dB of amplitude.

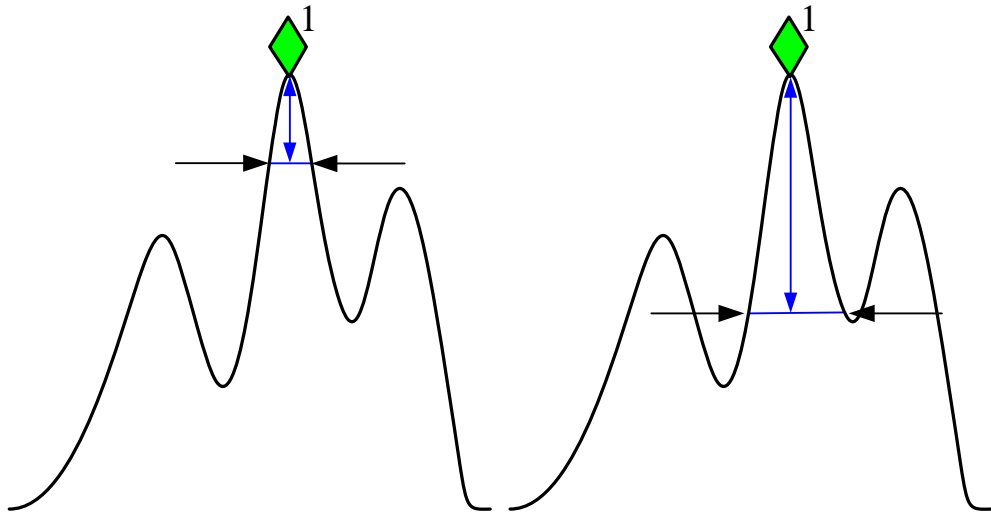

Common Measurement Functions 1

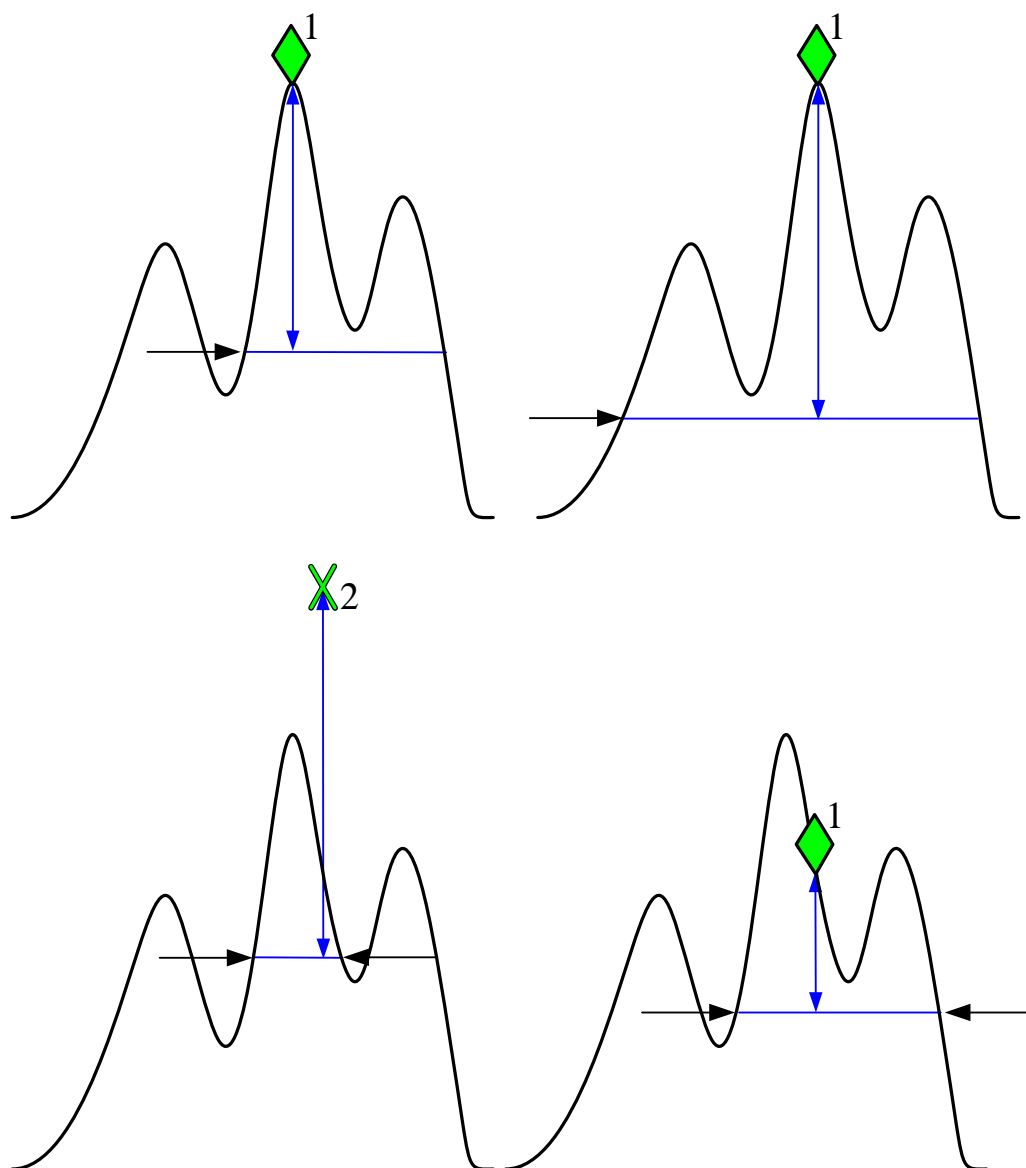

PhNoise Opt

Selects the LO (local oscillator) phase noise behavior for various desired operating conditions.

Remote Command:	<code>[:SENSe] :FREQuency:SYNTHeSis [:STATe] 1 2 3</code> <code>[:SENSe] :FREQuency:SYNTHeSis [:STATe] ?</code>
Example:	<code>FREQ:SYNT 2</code> selects optimization for best wide offset phase noise
Notes:	Parameter: 1 - optimizes phase noise for small frequency offsets from the carrier. 2 - optimizes phase noise for wide frequency offsets from the carrier. 3 - optimizes LO for tuning speed

Preset:	Because this function is in Auto after preset, and because Span after preset > 314.16 kHz (see Auto rules, next section) the state of this function after Preset is 2.
Dependencies:	Does not appear in all models. The key is blank in those models, but the SCPI command is accepted for compatibility (although no action is taken).
Initial S/W Revision:	Prior to A.02.00
Modified at S/W Revision:	A.02.00
Help Map ID:	3213

Auto

Selects the LO (local oscillator) phase noise behavior to optimize dynamic range and speed for various test set operating conditions.

The X-Series has two grades of LO; a high performance LO that gives the best phase noise performance; and a medium-performance LO that gives excellent performance.

In models with the high performance LO, Auto will choose:

Fast Tuning whenever Span > 44.44 MHz or RBW > 1.9 MHz

otherwise, if center frequency is < 195 kHz OR ALL of the following are true:

CF 1 MHz AND Span 1.3 MHz AND RBW 75 kHz

then Best Close in Phase Noise;

otherwise, Best Wide-offset Phase Noise

In models with the medium-performance LO, Auto will choose:

Fast Tuning whenever Span > 12.34 MHz or RBW > 250 kHz

otherwise, if center frequency is < 25 kHz OR ALL of the following are true:

CF >= 1 MHz AND Span <= 141.4 kHz AND RBW <= 5 kHz

then **Best Close in Phase Noise**;

otherwise, **Best Wide-offset Phase Noise**

In units whose hardware does not provide for an extra-fast tuning option, the settings for Fast Tuning are the same as Best Close-in, so in those models you will see no difference between these settings.

These rules apply whether in swept spans, zero span, or FFT spans.

Key Path	Meas Setup, PhNoise Opt
Remote Command	[:SENSe] :FREQuency:SYNTHeSis:AUTO [:STATe] OFF ON 0 1 [:SENSe] :FREQuency:SYNTHeSis:AUTO [:STATe] ?
Example	FREQ:SYNT:AUTO ON
Preset	ON

Common Measurement Functions 1

State Saved	Saved in instrument state.
Initial S/W Revision	Prior to A.02.00
Help Map ID	3215

Best Close-in P Noise

The LO phase noise is optimized for smaller offsets from the carrier, at the expense of phase noise farther out.

Key Path	Meas Setup, PhNoise Opt
Example	FREQ:SYNT 1
Couplings	offset <20 kHz
Readback	Close-in. If manually selected the “Man” is underlined. The actual frequency offset within which noise is optimized is shown with in square brackets, as this can vary depending on the hardware set in use. For example, in some test sets this annotation appears as [offset <20 kHz]
Initial S/W Revision	Prior to A.02.00
Help Map ID	3216

Best Wide-offset Noise

The LO phase noise is optimized for wider offsets from the carrier. Optimization is especially improved for offsets from 70 kHz to 300 kHz. Closer offsets are compromised and the throughput of measurements (especially remote measurements where the center frequency is changing rapidly), is reduced.

Key Path	Meas Setup, PhNoise Opt
Example	FREQ:SYNT 2
Couplings	offset >30 kHz
Readback	Wide-offset. If manually selected the “Man” is underlined. The actual frequency offset beyond which noise is optimized is shown with in square brackets, as this can vary depending on the hardware set in use. For example, in some test sets this annotation appears as [offset >30 kHz]
Initial S/W Revision	Prior to A.02.00
Help Map ID	3217

Fast Tuning

In this mode, the LO behavior compromises phase noise at many offsets from the carrier in order to allow rapid measurement throughput when changing the center frequency or span. The term “fast tuning” refers to the time it takes to move the local oscillator to the start frequency and begin a sweep;

this setting does not impact the actual sweep time in any way.

Key Path	Meas Setup, PhNoise Opt
Example	FREQ:SYNT 3
State Saved	Saved in instrument state.
Readback	Fast Tuning. Also, the “Man” must be underlined.
Initial S/W Revision	Prior to A.02.00
Help Map ID	3218

ADC Dither

Accesses the menu to control the ADC Dither function. The dither function enhances linearity for low level signals at the expense of reduced clipping-to-noise ratio. The reduced clipping-to-noise ratio results in higher noise, because we work to ensure that the clipping level of the ADC relative to the front terminals remains unchanged with the introduction of dither, and this results in reduced ADC dynamic range. So making measurements with ADC dither gives you better amplitude linearity, but turning ADC dither off gives you a lower noise floor (better sensitivity).

With dither on, the third-order distortions are usually invisible for mixer levels below -35 dBm. With dither off, these distortions can be visible, with typical power levels of -110 dBm referred to the mixer. Detection nonlinearity can reach 1 dB for dither off at mixer levels around -70 dBm and lower, while the specified nonlinearity is many times smaller with dither on.

When ADC Dither is on, the linearity of low-level signals is improved. The enhanced linearity is mostly improved scale fidelity. The linearity improvements of dither are most significant for RBWs of 3.9 kHz and less in swept mode, and FFT widths of 4 kHz and less in FFT mode.

The increased noise due to turning dither on is most significant in low band (0 to 3.6 GHz) with IF Gain set to Low, where it can be about 0.2 dB.

Key Path	Meas Setup
Example	ADC:DITH:HIGH Sets the ADC dither setting to High ADC:DITH ON Sets the ADC dither setting to Medium
Remote Command	[:SENSe] :ADC:DITHer [:STATe] OFF ON HIGH [:SENSe] :ADC:DITHer [:STATe] ?
Dependencies	
Preset	AUTO
Backwards Compatibility SCPI	The old command [:SENSe]:ADC:DITHer AUTO is aliased to [:SENSe]:ADC:DITHer:AUTO[:STATe] ON; because of this, the [:SENSe]:ADC:DITHer function cannot be a true Boolean, so the query, [:SENSe]:ADC:DITHer? returns OFF or ON (not 1 or 0 like a true Boolean)
Initial S/W Revision	Prior to A.02.00

Common Measurement Functions 1

Modified at S/W Revision	A.02.00
Help Map ID	3219

Auto

Sets the ADC dither to automatic. The test set then chooses the dither level according to which is most likely to be the best selection, based on other settings within the digital IF.

When in Auto, the test set sets the dither to Medium whenever the effective IF Gain is Low by this definition of IF Gain = Low:

- When Sweep Type = Swept, IF Gain = Low whenever Swept IF Gain is set to Low Gain, whether by auto coupling or manual selection.
- When Sweep Type = FFT, IF Gain = Low whenever FFT IF Gain is set to "Low Gain," which cannot happen by auto coupling.

Whenever the IF Gain is not low by this definition, Auto sets the dither to Off.

Key Path	Meas Setup, ADC Dither
Remote Command	[:SENSe] :ADC:DITHer:AUTO [:STATe] OFF ON 0 1 [:SENSe] :ADC:DITHer:AUTO [:STATe] ?
Example	ADC:DITH:AUTO ON
Preset	ON
State Saved	Saved in instrument state
Readback	The "Auto" is underlined, and the readback value is whatever setting is auto-selected
Initial S/W Revision	Prior to A.02.00
Help Map ID	3220

High (Best Log Accy)

When ADC dither is set to High, the scale fidelity is especially good, most notably the relative scale fidelity. The trade off is that there is a modest loss of noise floor performance, up to about a decibel.

Key Path	Meas setup, ADC Dither
Example	ADC:DITH:HIGH
Readback	If manually selected, the readback is High, with the "Man" underlined
Initial S/W Revision	A.02.00
Help Map ID	3869

Medium (Log Accy)

The Medium setting of ADC Dither (known as "On" in earlier versions of the test set software) improves

the linearity of low-level signals at the expense of some noise degradation.

Key Path	Meas setup, ADC Dither
Example	ADC:DITH:ON
Readback	If manually selected, the readback is Medium, with the “Man” underlined
Initial S/W Revision	Prior to A.02.00
Modified at S/W Revision	A.02.00
Help Map ID	3221

Off (Best Noise)

When ADC Dither is Off, the test set noise floor is improved, because without the need to make room for the dither, you get a lower noise floor and better sensitivity.

Key Path	Meas setup, ADC Dither
Example	ADC:DITH:OFF
Readback	If manually selected, the readback is Off, with the “Man” underlined.
Initial S/W Revision	Prior to A.02.00
Help Map ID	3222

Swept IF Gain

To take full advantage of the RF dynamic range of the test set, there is an added switched IF amplifier with approximately 10 dB of gain. When you can turn it on without overloading the test set, the dynamic range is always better with it on than off. The **Swept IF Gain** key can be used to set the IF Gain function to Auto, or to High Gain (the extra 10 dB), or to Low Gain. These settings affect sensitivity and IF overloads.

This function is only active when in Swept sweeps. In FFT sweeps, the FFT IF Gain function is used instead.

Key Path	Meas Setup
Remote Command	[:SENSE] : IF : GAIN : SWEPT [: STATE] OFF ON 0 1 [:SENSE] : IF : GAIN : SWEPT [: STATE] ?
Example	IF:GAIN:SWEP ON
Notes	where ON = high gain OFF = low gain

Common Measurement Functions 1

Couplings	<p>The 'auto' rules for Swept IF Gain depend on attenuation, preamp state, start and stop frequency and the setting of FFT IF Gain. Set the Swept IF Gain to High (On) when the total input attenuation is 0 dB, the preamp is off, the start frequency is 10 MHz or more, and the FFT IF Gain is auto coupled, or manually set to Autorange, or manually set to High. Also set the Swept IF Gain to High (On) when the total input attenuation is 2 dB or less, the preamp is on, the start frequency is 10 MHz or more, and the stop frequency is 3.6 GHz or less and the FFT IF Gain is auto coupled, or manually set to Uttering, or manually set to High. Under all other circumstances, set the Swept IF Gain to Low (Off).</p> <p>If the sweep type is Swept, the start frequency of the test set is less than 10 MHz, and you put Swept IF Gain in Manual On, a warning condition is generated and remains in effect as long as this condition exists. The warning message is about a possible IF overload.</p> <p>As with most parameters with an AUTO state, AUTO COUPLE sets it to Auto, and setting any specific value (for example on or off) will set the AUTO state to false.</p>
Preset	<p>Auto after a Preset which yields Off unless the Preamp is on.</p> <p>Auto and Off after Meas Preset.</p>
State Saved	Saved in instrument state.
Readback Line	High Gain or Low Gain
Initial S/W Revision	Prior to A.02.00
Help Map ID	3223

Auto

Activates the auto rules for Swept IF Gain

Key Path	Meas setup
Remote Command	<pre>[:SENSe] : IF : GAIN : SWEPT : AUTO [: STATE] OFF ON 0 1 [:SENSe] : IF : GAIN : SWEPT : AUTO [: STATE] ?</pre>
Example	IF:GAIN:SWEP:AUTO ON
Preset	ON
Initial S/W Revision	Prior to A.02.00
Help Map ID	3224

Low Gain (Best for Large Signals)

Forces Swept IF Gain to be off.

Key Path	Meas setup, ADC Ranging
Example	IF:GAIN:SWEP OFF

State Saved	Saved in instrument state.
Readback	Low Gain
Initial S/W Revision	Prior to A.02.00
Help Map ID	3225

High Gain (Best Noise Level)

Forces Swept IF Gain to be on.

Key Path	Meas setup, ADC Ranging
Example	IF:GAIN:SWEP ON
Dependencies	The High setting for Swept IF Gain is grayed out when FFT IF Gain is manually set to Low (not when Low is chosen by the auto-rules).
State Saved	Saved in instrument state.
Readback	High Gain
Initial S/W Revision	Prior to A.02.00
Help Map ID	3226

FFT IF Gain

Accesses the keys to set the ranging in the digital IF when doing FFT sweeps. When in Autorange mode, the IF checks its range once for every FFT chunk, to provide the best signal to noise ratio. You can specify the range for the best FFT speed, and optimize for noise or for large signals.

When the sweep type is FFT and this function is in Autorange, the IF Gain is set ON initially for each chunk of data. The data is then acquired. If the IF overloads, then the IF Gain is set OFF and the data is re-acquired. Because of this operation, the Auto setting uses more measurement time as the test set checks/resets its range. You can get faster measurement speed by forcing the range to either the high or low gain setting. But you must know that your measurement conditions will not overload the IF (in the high gain range) and that your signals are well above the noise floor (for the low gain range), and that the signals are not changing.

Key Path	Meas Setup
Remote Command	[:SENSE] : IF:GAIN:FFT [:STATe] AUTOrange LOW HIGH [:SENSe] : IF:GAIN:FFT [:STATe] ?
Couplings	As with most parameters with an AUTO state, AUTO COUPLE sets it to Auto, which then picks Autorange, and setting any specific value (AUTOrange, LOW or HIGH) will set the AUTO state to false.
Preset	AUTOrange
State Saved	Saved in instrument state.
Readback Line	Autorange, High Gain or Low Gain

Common Measurement Functions 1

Initial S/W Revision	Prior to A.02.00
Help Map ID	3227

Auto

Allows the test set to pick the FFT IF Gain method as appropriate. This “Auto” state is set by the Auto Couple key, and it puts it in Autorange.

Key Path	Meas setup
Remote Command	[:SENSE] : IF : GAIN : FFT : AUTO [: STATE] OFF ON 0 1 [:SENSE] : IF : GAIN : FFT : AUTO [: STATE] ?
Example	IF:GAIN:FFT:AUTO ON
Preset	ON
State Saved	Saved in instrument state.
Backwards Compatibility SCPI	DISPlay:WINDow[1]:TRACe:Y[:SCALe]:LOG:RANGe:AUTO
Initial S/W Revision	Prior to A.02.00
Help Map ID	3228

Autorange (Slower – Follows Signals)

Turns the ADC ranging to automatic which provides the best signal to noise ratio. Autorange is usually preferred over the manual range choices.

Key Path	Meas setup, FFT IF Gain
Example	IF:GAIN:FFT AUTOrange
State Saved	Saved in instrument state.
Readback	Autorange
Initial S/W Revision	Prior to A.02.00
Help Map ID	3229

Low Gain (Best for Large Signals)

Forces FFT IF Gain to be off.

Key Path	Meas setup, FFT IF Gain
Example	IF:GAIN:FFT LOW
State Saved	Saved in instrument state.
Readback	Low Gain
Initial S/W Revision	Prior to A.02.00

Help Map ID	3230
-------------	------

High Gain (Best Noise Level)

Forces FFT IF Gain to be on.

Key Path	Meas setup, FFT IF Gain
Example	IF:GAIN:FFT HIGH
Dependencies	The High setting for FFT IF Gain is grayed out when Swept IF Gain is manually set to Low (not when Low is chosen by the auto-rules).
State Saved	Saved in instrument state.
Readback	High Gain
Initial S/W Revision	Prior to A.02.00
Help Map ID	3231

Analog Demod Tune & Listen

The Analog Demod Tune & Listen key opens the Analog Demod menu which contains keys to turn the demod function on and off and select modulation type. This key only appears if the U9063A Analog Demod personality is installed and licensed.

When the function is on (set to AM, FM, or PM), the demodulated signal is fed to the test set's speaker. Muting and volume control functions are done through the standard Windows speaker volume control interface.

Key Path	Meas Setup
Remote Command	[:SENSe] :DEMod AM FM PM OFF [:SENSe] :DEMod?
Example	DEM AM turns amplitude demodulation function ON
Dependencies	When Tune & Listen is turned on, all active traces are forced to use the same detector. CISPR detectors (QPD, EMI Avg, RMS Avg) and Tune & Listen are mutually exclusive. No sound output is heard if one of these detectors is selected.
Preset	OFF
State Saved	Saved in instrument state.
Initial S/W Revision	Prior to A.02.00
Modified at S/W Revision	A.02.00
Help Map ID	3800

Common Measurement Functions 1

AM

Pressing this key, when it is not selected, selects and activates the AM demodulation function. Pressing it a second time branches to the AM Demod menu where AM demodulation settings can be adjusted.

Key Path	Meas Setup, Analog Demod Tune&Listen
State Saved	Saved in instrument state.
Initial S/W Revision	Prior to A.02.00
Help Map ID	3801

Channel BW (AM Demod)

Sets the RBW setting used by the hardware during the demodulation period in nonzero spans. Note that this is a separate parameter only for the demodulation function and does not affect the RBW setting in the BW menu which is used during the normal sweep. The flat top filter type must be used during the demodulation period. A 5 kHz Video Bandwidth filter is used.

In Zero Span, the test set's RBW & VBW filters are used for the demodulation; thus, the Channel BW (and RBW filter type) will match those of the test set. This allows gap-free listening. The Channel BW key is grayed out and the value displayed on the key matches the current RBW of the test set. Upon leaving zero span, the non-zero-span setting of Channel BW is restored as well as the flattop filter type.

Key Path	Meas Setup, Analog Demod Tune&Listen, AM
Remote Command	[:SENSE] :DEMod:AM:BA NDwidth:CHANnel <freq> [:SENSE] :DEMod:AM:BA NDwidth:CHANnel?
Example	DEM:AM:BA ND:CHAN 200 kHz
Notes	This key/command is grayed out in zero span.
Dependencies	Unavailable in zero span.
Couplings	In zero span only, the value is set equal to the test set's current RBW value and it displays that value on the key, but the key is grayed out.
Preset	30 kHz
State Saved	Saved in instrument state.
Min	390 Hz
Max	8 MHz
Default Unit	Hz
Initial S/W Revision	Prior to A.02.00
Help Map ID	3802

FM

Pressing this key, when it is not selected, selects and activates the FM demodulation function. Pressing it

a second time branches to the FM Demod menu where FM demodulation settings can be adjusted.

Key Path	Meas Setup, Analog Demod Tune&Listen
Example	DEM FM turns frequency demodulation function ON
State Saved	Saved in instrument state.
Initial S/W Revision	Prior to A.02.00
Help Map ID	3803

Channel BW (FM Demod)

Sets the RBW setting used by the hardware during the demodulation period in nonzero spans. Note that this is a separate parameter only for the demodulation function and does not affect the RBW setting in the BW menu which is used during the normal sweep. The flat top filter type must be used during the demodulation period. A 5 kHz Video Bandwidth filter is used.

In Zero Span, the test set’s RBW & VBW filters are used for the demodulation; thus, the Channel BW (and RBW filter type) will match those of the test set. This allows gap-free listening. The Channel BW key is grayed out and the value displayed on the key matches the current RBW of the test set. Upon leaving zero span, the previous setting of Channel BW and the flattop filter type are restored.

Key Path	Meas Setup, Analog Demod Tune&Listen, FM
Remote Command	[:SENSe] :DEMod:FM:BANDwidth:CHANnel <freq> [:SENSe] :DEMod:FM:BANDwidth:CHANnel?
Example	DEM:FM:BAND:CHAN 200 MHz
Notes	This key / command is grayed out in zero span
Dependencies	Unavailable in zero span.
Couplings	In zero span only, the value is set equal to the test set’s current RBW value and it displays that value on the key, but the key is grayed out.
Preset	150 kHz
State Saved	Saved in instrument state.
Min	390 Hz
Max	8 MHz
Default Unit	Hz
Initial S/W Revision	Prior to A.02.00
Help Map ID	3804

De-emphasis (FM Demod only)

The De-emphasis setting controls a single-pole filter (6 dB/octave roll off), usually to counter intentional pre-emphasis in the transmitter. When De-emphasis state is OFF the hardware digital filter is bypassed,

Common Measurement Functions 1

otherwise the setting is applied

The De-emphasis key is only available when FM is the demod selected. It is grayed out for AM and PM.

Key Path	Meas Setup, Analog Demod Tune & Listen, FM
Remote Command	[[:SENSE]:DEMod:FM:DEEMphasis OFF US25 US50 US75 US750 [:SENSE]:DEMod:FM:DEEMphasis?
Example	DEM:FM:DEEM US75 DEM:FM:DEEM?
Dependencies	Only available in FM. Grayed out for AM and PM.
Preset	US75 (recommended for US commercial FM 75 μ s pre-emphasis)
State Saved	Saved in instrument state.
Readback line	1-of-N selection
Initial S/W Revision	Prior to A.02.00
Help Map ID	3805

Off

This setting bypasses the De-emphasis filter.

Key Path	Meas Setup, Analog Demod Tune&Listen, FM, De-emphasis
Example	DEM:FM:DEEM OFF
Readback	Off
Initial S/W Revision	Prior to A.02.00
Help Map ID	3858

25 μ s

Sets the De-emphasis time constant to 25 μ s.

Key Path	Meas Setup, Analog Demod Tune&Listen, FM, De-emphasis
Example	DEM:FM:DEEM US25
Readback	25 μ s
Initial S/W Revision	Prior to A.02.00
Help Map ID	3859

50 μ s

Sets the De-emphasis time constant to 50 μ s.

Key Path	Meas Setup, Analog Demod Tune&Listen, FM, De-emphasis
Example	DEM:FM:DEEM US50
Readback	50 μ s
Initial S/W Revision	Prior to A.02.00
Help Map ID	3860

75 μ s

Sets the De-emphasis time constant to 75 μ s.

Key Path	Meas Setup, Analog Demod Tune&Listen, FM, De-emphasis
Example	DEM:FM:DEEM US75
Readback	75 μ s
Initial S/W Revision	Prior to A.02.00
Help Map ID	3861

750 μ s

Sets the De-emphasis time constant to 750 μ sec.

Key Path	Meas Setup, Analog Demod Tune&Listen, FM, De-emphasis
Example	DEM:FM:DEEM US750
Readback	750 μ s
Initial S/W Revision	Prior to A.02.00
Help Map ID	3862

PM

Pressing this key, when it is not selected, selects and activates the PM demodulation function. Pressing it a second time branches to the PM Demod menu where PM demodulation settings can be adjusted.

Key Path	Meas Setup, Analog Demod Tune&Listen
Example	DEM PM turns Phase demodulation function ON
State Saved	Saved in instrument state.
Initial S/W Revision	Prior to A.02.00
Help Map ID	3806

Common Measurement Functions 1

Channel BW (PM Demod)

Sets the RBW setting used by the hardware during the demodulation period in nonzero spans. Note that this is a separate parameter only for the demodulation function and does not affect the RBW setting in the BW menu which is used during the normal sweep. The flat top filter type must be used during the demodulation period. A 5 kHz Video Bandwidth filter is used.

In Zero Span, the test set's RBW & VBW filters are used for the demodulation; thus, the Channel BW (and RBW filter type) will match those of the test set. This allows gap-free listening. The Channel BW key is grayed out and the value displayed on the key matches the current RBW of the test set. Upon leaving zero span, the previous setting of Channel BW and the flattop filter type are restored.

Key Path	Meas Setup, Analog Demod Tune&Listen, M
Remote Command	[:SENSE] :DEMod:PM:BANDwidth:CHANnel <freq> [:SENSE] :DEMod:PM:BANDwidth:CHANnel?
Example	DEM:PM:BAND:CHAN 200 MHz
Notes	This key / command is grayed out in zero span
Dependencies	Unavailable in zero span.
Couplings	In zero span only, the value is set equal to the test set's current RBW value and it displays that value on the key, but the key is grayed out.
Preset	100 kHz
State Saved	Saved in instrument state.
Min	390 Hz
Max	8 MHz
Default Unit	Hz
Initial S/W Revision	Prior to A.02.00
Help Map ID	3807

Off

Pressing this key, turns the demodulation function off.

Key Path	Meas Setup, Analog Demod Tune&Listen
Example	DEM OFF turns the demodulation function OFF
State Saved	Saved in instrument state.
Initial S/W Revision	Prior to A.02.00
Help Map ID	3808

Demod Time

Sets the amount of time the test set demodulates the signal after each sweep. The demodulated signal can be heard through the speaker during demodulation. In zero span, demodulation can be performed continuously, making this parameter not applicable, hence it is grayed out in zero span.

Key Path	Meas Setup, Analog Demod Tune&Listen
Remote Command	[:SENSe] :DEMod:TIME <time> [:SENSe] :DEMod:TIME?
Example	DEM:TIME 500 ms DEM:TIME?
Notes	This key / command is grayed out in zero span
Dependencies	Unavailable in zero span.
Preset	500 ms
State Saved	Saved in instrument state.
Min	2 ms
Max	100 s
Initial S/W Revision	Prior to A.02.00
Help Map ID	3809

Demod State (Remote Command Only)

Sets or queries the state of the Analog Demod Tune and Listen function. Setting the state to ON with this command will select AM demodulation by default and activate it (turn it on).

The response to the query is determined by the current setting of [:SENSe] :DEMod AM|FM|PM|OFF. The response is 1 if AM, FM, PM are selected, or 0 if OFF is selected.

Remote Command:	[:SENSe] :DEMod:STATe OFF ON 0 1 [:SENSe] :DEMod:STATe?
Preset:	OFF
Initial S/W Revision:	Prior to A.02.00
Help Map ID:	0

Mode

The Mode key allows you to select the available measurement applications or “Modes”. Modes are a collection of measurement capabilities packaged together to provide an instrument personality that is specific to your measurement needs. Each application software product is ordered separately by Model Number and must be licensed to be available. Once an instrument mode is selected, only the commands that are valid for that mode can be executed.

Common Measurement Functions 1

NOTE Key operation can be different between modes. The information displayed in Help is about the current mode.

To access Help for a different Mode you must first exit Help (by pressing the Cancel (Esc) key). Then select the desired mode and re-access Help.

For more information on Modes, preloading Modes, and memory requirements for Modes, see [“More Information” on page 1455](#)

Key Path:	Front-panel key
Remote Command:	: INStRument [: SELEct] SEQAN BASIC WCDMA EDGEgSM WIMAXOFDMA ADEMOD BT00th TDSC DMA CDMA2K CDMA1XEV LTE LTETDD : INStRument [: SELEct] ?
Example:	INST SEQAN
Notes:	The available parameters are dependent upon installed and licensed applications resident in the instrument. Parameters given here are an example, specific parameters are in the individual Application. A list of the valid mode choices is returned with the INST:CAT? Query.
Preset:	Not affected by Preset. In the EXT, the mode set by Restore System Defaults is the Sequence Analyzer mode.
State Saved:	Saved in instrument state
Backwards Compatibility SCPI:	: INStRument[: SELEct] GSM provided for backwards compatibility. Mapped to EDGEgSM.
Backwards Compatibility SCPI:	: INStRument[: SELEct] SANalyzer provided for ESU compatibility. When this command is received, the analyzer aliases it to the following: INST:SEL SCPI LC This results in the analyzer being placed in SCPI Language Compatibility Mode, in order to emulate the ESU Spectrum Analyzer Mode.
Backwards Compatibility SCPI:	: INStRument[: SELEct] RECEiver provided for ESU compatibility. When this command is received, the analyzer aliases it to the following: : INST:SEL EMI : CONF FSC This results in the analyzer being placed in the EMI Receiver Mode, running the Frequency Scan measurement, in order to emulate the ESU Receiver Mode.
Initial S/W Revision:	Prior to A.02.00

Modified at S/W Revision:	A.10.01
Help Map ID:	2670
Example:	INST 'SEQAN'?
Notes:	The query is not a quoted string. It is an enumeration as indicated in the Instrument Select table above. The command must be sequential: i.e. continued parsing of commands cannot proceed until the instrument select is complete and the resultant SCPI trees are available.
Backwards Compatibility SCPI:	:INSTrument[:SElect] 'GSM' 'BASIC'
Initial S/W Revision:	Prior to A.02.00
Help Map ID:	0

More Information

It is possible to specify the order in which the Modes appear in the Mode menu, using the Configure Applications utility (**System, Power On, Configure Applications**). It is also possible, using the same utility, to specify a subset of the available applications to load into memory at startup time, which can significantly decrease the startup time of the test set. During runtime, if an application that is not loaded into memory is selected (by either pressing that applications Mode key or sending that applications :INST:SEL command over SCPI), there will be a pause while the Application is loaded. During this pause a message box that says “Loading application, please wait...” is displayed.

Each application (Mode) that runs in the X-Series test set consumes virtual memory. The various applications consume varying amounts of virtual memory, and as more applications run, the memory consumption increases. Once an application is run, some of its memory remains allocated even when it is not running, and is not released until the test set program (xSA.exe) is shut down.

Agilent characterizes each Mode and assigns a memory usage quantity based on a conservative estimate. There is a limited amount of virtual memory available to applications (note that this is virtual memory and is independent of how much physical RAM is in the instrument). The instrument keeps track of how much memory is being used by all loaded applications – which includes those that preloaded at startup, and all of those that have been run since startup.

When you request a Mode that is not currently loaded, the instrument looks up the memory estimate for that Mode, and adds it to the residual total for all currently loaded Modes. If there is not enough virtual memory to load the Mode, a dialog box and menu will appear that gives you four options:

Close and restart the test set program without changing your configured preloads. This may free up enough memory to load the requested Mode, depending on your configured preloads

Clear out all preloads and close and restart the test set program with only the requested application preloaded, and with that application running. This choice is guaranteed to allow you to run the requested application; but you will lose your previously configured preloads. In addition, there may be little or no room for other applications, depending on the size of the requested application.

Bring up the Configure Applications utility in order to reconfigure the preloaded apps to make room for the applications you want to run (this will then require restarting the test set program with your new

Common Measurement Functions 1

configuration). This is the recommended choice because it gives you full flexibility to select exactly what you want.

Exit the dialog box without doing anything, which means you will be unable to load the application you requested.

In each case except 4, this will cause the test set software to close, and you will lose all unsaved traces and results.

If you attempt to load a mode via SCPI that will exceed memory capacity, the Mode does not load and an error message is returned:

```
-225, "Out of memory; Insufficient resources to load Mode (mode name) "
```

where “mode name” is the SCPI parameter for the Mode in question, for example, BASIC for IQ Analyzer Mode.

Application Mode Number Selection (Remote Command Only)

Select the measurement mode by its mode number. The actual available choices depend upon which applications are installed in your instrument. The modes appear in this table in the same order they appear in the Mode menu (if the order is not changed by the Configure Applications utility found in the **System, Power On** menu). See [“Detailed List of Modes” on page 1460](#) for Mode details.

The Mode Number is the parameter for use with the :INSTRument:NSElect command. The Mode Parameter is the parameter for use with the :INSTRument[:SElect] command.

Mode	Mode Number	Mode Parameter
Sequence Analyzer	400	SEQAN
I/Q Analyzer (Basic)	8	BASIC
WCDMA with HSPA+	9	WCDMA
GSM/EDGE/EDGE Evo	13	EDGE GSM
802.16 OFDMA (WiMAX/WiBro)	75	WIMAXOFDMA
Analog Demod	234	ADEMOD
Bluetooth	228	BTooth
TD-SCDMA with HSPA/8PSK	211	TDSCDMA
cdma2000	10	CDMA2K
1xEV-DO	15	CDMA1XEV
LTE	102	LTE
LTE TDD	105	LTETDD

Remote Command:	:INSTRument:NSElect <integer> :INSTRument:NSElect?
------------------------	---

Example:	:INST:NSEL 1
Notes:	The command must be sequential: i.e. continued parsing of commands cannot proceed until the instrument select is complete and the resultant SCPI trees are available.
Preset:	Not affected by Preset. Set to default mode following Restore System Defaults.
State Saved:	Saved in instrument state
Initial S/W Revision:	Prior to A.02.00
Help Map ID:	0

Application Mode Catalog Query (Remote Command Only)

Returns a string containing a comma separated list of names of all the installed and licensed measurement modes (applications). These names can only be used with the :INSTrument[:SELEct] command.

Remote Command:	:INSTrument:CATalog?
Example:	:INST:CAT?
Notes:	Query returns a quoted string of the installed and licensed modes separated with a comma. Example: "BASIC,EDGE GSM,CDMA"
Backwards Compatibility Notes:	VSA (E4406A) :INSTrument:CATalog? returned a list of installed INSTrument:SELECT items as a comma separated list of string values: "BASIC","GSM","EDGE GSM","CDMA","NADC","PDC","WCDMA","CDMA2K","CDMA1XEV","IDEN","WIDEN","WLAN","SERVICE" X-Series uses the ESA/PSA compatible query of a string contain comma separated values: "BASIC,CDMA,CDMA2K,WCDMA,CDMA1XEV,EDGE GSM,GSM,TDS CDMA,DMODULATION,WLAN"
Initial S/W Revision:	Prior to A.02.00
Help Map ID:	0

Application Identification (Remote Commands Only)

Each entry in the Mode Menu will have a Model Number and associated information: Version, and Options.

This information is displayed in the Show System screen. The corresponding SCPI remote commands are defined here.

[“Current Application Model ” on page 1458](#)

[“Current Application Revision” on page 1458](#)

[“Current Application Options” on page 1458](#)

Common Measurement Functions 1

Current Application Model

Returns a string that is the Model Number of the currently selected application (mode).

Remote Command:	:SYSTem:APPLication[:CURRent] [:NAME] ?
Example:	:SYST:APPL?
Notes:	Query returns a quoted string that is the Model Number of the currently selected application (Mode). Example: "N9060A" String length is 6 characters.
Preset:	Not affected by Preset
State Saved:	Not saved in state, the value will be the selected application when a Save is done.
Initial S/W Revision:	Prior to A.02.00
Help Map ID:	0

Current Application Revision

Returns a string that is the Revision of the currently selected application (mode).

Remote Command:	:SYSTem:APPLication[:CURRent] :REVIsion?
Example:	:SYST:APPL:REV?
Notes:	Query returns a quoted string that is the Revision of the currently selected application (Mode). Example: "1.0.0.0" String length is a maximum of 23 characters. (each numeral can be an integer + 3 decimal points)
Preset:	Not affected by a Preset
State Saved:	Not saved in state, the value will be the selected application when a Save is done.
Initial S/W Revision:	Prior to A.02.00
Help Map ID:	0

Current Application Options

Returns a string that is the Options list of the currently selected application (Mode).

Remote Command:	:SYSTem:APPLication[:CURRent] :OPTion?
Example:	:SYST:APPL:OPT?

Notes:	Query returns a quoted string that is the Option list of the currently selected application (Mode). The format is the name as the *OPT? or SYSTem:OPTion command: a comma separated list of option identifiers. Example: "1FP,2FP" String length is a maximum of 255 characters.
Preset:	Not affected by a Preset
State Saved:	Not saved in state per se, the value will be the selected application when a Save is invoked.
Initial S/W Revision:	Prior to A.02.00
Help Map ID:	0

Application Identification Catalog (Remote Commands Only)

A catalog of the installed and licensed applications (Modes) can be queried for their identification.

[“Application Catalog Number of Entries” on page 1459](#)

[“Application Catalog Revision” on page 1460](#)

[“Application Catalog Options” on page 1460](#)

Application Catalog Number of Entries

Returns the number of installed and licensed applications (Modes).

Remote Command:	:SYSTem:APPLication:CATalog[:NAME]:COUNT?
Example:	:SYST:APPL:CAT:COUN?
Preset:	Not affected by Preset
State Saved:	Not saved in instrument state.
Initial S/W Revision:	Prior to A.02.00
Help Map ID:	0

Application Catalog Model Numbers

Returns a list of Model Numbers for the installed and licensed applications (Modes).

Remote Command:	:SYSTem:APPLication:CATalog[:NAME]?
Example:	:SYST:APPL:CAT?
Notes:	Returned value is a quoted string of a comma separated list of Model Numbers. Example, if SAMS and Phase Noise are installed and licensed: "N9060A,N9068A" String length is COUNT * 7 - 1. (7 = Model Number length + 1 for comma. -1 = no comma for the 1st entry.)

Common Measurement Functions 1

Preset:	Not affected by a Preset
State Saved:	Not saved in instrument state.
Initial S/W Revision:	Prior to A.02.00
Help Map ID:	0

Application Catalog Revision

Returns the Revision of the provided Model Number.

Remote Command:	:SYSTem:APPLication:CATalog:REVIion? <model>
Example:	:SYST:APPL:CAT:REV? 'N9060A'
Notes:	Returned value is a quoted string of revision for the provided Model Number. The revision will be a null-string (") if the provided Model Number is not installed and licensed. Example, if SAMS is installed and licensed: "1.0.0.0"
Preset:	Not affected by a Preset.
State Saved:	Not saved in instrument state.
Initial S/W Revision:	Prior to A.02.00
Help Map ID:	0

Application Catalog Options

Returns a list of Options for the provided Model Number

Remote Command:	:SYSTem:APPLication:CATalog:OPTion? <model>
Example:	:SYST:APPL:CAT:OPT? 'N9060A'
Notes:	Returned value is a quoted string of a comma separated list of Options, in the same format as *OPT? or :SYSTem:OPTion?. If the provided Model Number is not installed and licensed a null-string (") will be returned. Example, if SAMS is installed and licensed: "2FP" String length is a maximum of 255 characters.
Preset:	Not affected by a Preset
State Saved:	Not saved in instrument state.
Initial S/W Revision:	Prior to A.02.00
Help Map ID:	0

Detailed List of Modes

This section contains an alphabetical list of Modes available in the X-Series, along with a brief

description of each Mode.

Note that with the exception of the 89601 VSA, only licensed applications appear in the Mode menu. The 89601 will always appear, because it's licensing is handled differently.

1xEV-DO

Selects the 1xEV-DO mode for general purpose measurements of signals following this standard. There are several measurements available in this mode.

If you are using the Help feature, this mode must be currently active to access its detailed information. If it is not active, exit the Help feature (Esc key), select the mode, and re-access Help.

Key Path:	Mode
Example:	INST:SEL CDMA1XEV INST:NSEL 15
Initial S/W Revision:	Prior to A.02.00
Help Map ID:	3566

802.16 OFDMA (WiMAX/WiBro)

Selects the OFDMA mode for general purpose measurements of WiMAX signals. There are several measurements available in this mode.

If you are using the Help feature, this mode must be currently active to access its detailed information. If it is not active, exit the Help feature (Esc key), select the mode, and re-access Help.

Key Path:	Mode
Example:	INST:SEL WIMAXOFDMA INST:NSEL 75
Initial S/W Revision:	Prior to A.02.00
Help Map ID:	3531

Analog Demod

Selects the Analog Demod mode for making measurements of AM, FM and phase modulated signals.

If you are using the Help feature, this mode must be currently active to access its detailed information. If it is not active, exit the Help feature (Esc key), select the mode, and re-access Help.

Key Path:	Mode
Example:	INST:SEL ADEMOD INST:NSEL 234
Initial S/W Revision:	Prior to A.02.00
Help Map ID:	3529

Common Measurement Functions 1

Bluetooth

Selects the Bluetooth mode for Bluetooth specific measurements. There are several measurements available in this mode.

If you are using the Help feature, this mode must be currently active to access its detailed information. If it is not active, exit the Help feature (Esc key), select the mode, and re-access Help.

Key Path:	Mode
Example:	INST:SEL BT INST:NSEL 228
Initial S/W Revision:	A.06.01
Help Map ID:	30035

cdma2000

Selects the cdma2000 mode for general purpose measurements of signals following this standard. There are several measurements available in this mode.

If you are using the Help feature, this mode must be currently active to access its detailed information. If it is not active, exit the Help feature (Esc key), select the mode, and re-access Help.

Key Path:	Mode
Example:	INST:SEL CDMA2K INST:NSEL 10
Initial S/W Revision:	Prior to A.02.00
Help Map ID:	3533

GSM/EDGE/EDGE Evo

Selects the GSM with EDGE mode for general purpose measurements of signals following this standard. There are several measurements available in this mode.

If you are using the Help feature, this mode must be currently active to access its detailed information. If it is not active, exit the Help feature (Esc key), select the mode, and re-access Help.

Key Path:	Mode
Example:	INST:SEL EDGEGSM INST:NSEL 13
Initial S/W Revision:	Prior to A.02.00
Modified at S/W Revision:	A.02.00
Help Map ID:	3532

IQ Analyzer (Basic)

The IQ Analyzer Mode makes general purpose frequency domain and time domain measurements. These measurements often use alternate hardware signal paths. These frequency domain and time domain measurements can be used to output I/Q data results when measuring complex modulated digital signals.

If you are using the Help feature, this mode must be currently active to access its detailed information. If it is not active, exit the Help feature (Esc key), select the mode, and re-access Help.

Key Path:	Mode
Example:	INST:SEL BASIC INST:NSEL 8
Initial S/W Revision:	Prior to A.02.00
Help Map ID:	3526

LTE

Selects the LTE mode for general purpose measurements of signals following the LTE FDD standard. There are several measurements available in this mode.

If you are using the Help feature, this mode must be currently active to access its detailed information. If it is not active, exit the Help feature (Esc key), select the mode, and re-access Help.

Key Path:	Mode
Example:	INST:SEL LTE INST:NSEL 102
Initial S/W Revision:	Prior to A.02.00
Help Map ID:	3586

LTE TDD

Selects the LTE TDD mode for general purpose measurements of signals following the LTE TDD standard. There are several measurements available in this mode.

If you are using the Help feature, this mode must be currently active to access its detailed information. If it is not active, exit the Help feature (Esc key), select the mode, and re-access Help.

Key Path:	Mode
Example:	INST:SEL LTETDD INST:NSEL 105
Initial S/W Revision:	A.03.00
Help Map ID:	44220

Common Measurement Functions 1

Sequence Analyzer

Selects the Sequence Analyzer mode for sequenced measurements. Depending on licensed applications there may be a number of different measurements available in this mode. These measurements are all done on IQ captured data and can be set up to calculated on any part of the capture.

If you are using the Help feature, this mode must be currently active to access its detailed information. If it is not active, exit the Help feature (Esc key), select the mode, and re-access Help.

Key Path:	Mode
Example:	INST:SEL SEQAN INST:NSEL 400
Initial S/W Revision:	A.05.01
Help Map ID:	30033

TD-SCDMA with HSPA/8PSK

Selects the TD-SCDMA mode for general purpose measurements of signals following this standard. There are several measurements available in this mode.

If you are using the Help feature, this mode must be currently active to access its detailed information. If it is not active, exit the Help feature (Esc key), select the mode, and re-access Help.

Key Path:	Mode
Example:	INST:SEL TDSCDMA INST:NSEL 211
Initial S/W Revision:	Prior to A.02.00
Help Map ID:	3534

W-CDMA with HSPA+

Selects the W-CDMA with HSPA+ mode for general purpose measurements of signals following this standard. There are several measurements available in this mode.

If you are using the Help feature, this mode must be currently active to access its detailed information. If it is not active, exit the Help feature (Esc key), select the mode, and re-access Help.

Key Path:	Mode
Example:	INST:SEL WCDMA INST:NSEL 9
Initial S/W Revision:	Prior to A.02.00
Help Map ID:	3530

Global Settings

Opens up a menu that allows you to switch certain Meas Global parameters to a Mode Global state. These switches apply to all Modes that support global settings. No matter what Mode you are in when you set the “Global Center Frequency” switch to on, it applies to all Modes that support Global Settings.

Key Path:	Front Panel Key
Initial S/W Revision:	Prior to A.02.00
Help Map ID:	4003

Global Center Freq

The software maintains a Mode Global value called “Global Center Freq”.

When the **Global Center Freq** key is switched to **On** in any mode, the current mode’s center frequency is copied into the Global Center Frequency, and from then on all modes which support global settings use the Global Center Frequency. So you can switch between any of these modes and the Center Freq will remain unchanged.

Adjusting the Center Freq of any mode which supports Global Settings, while **Global Center Freq** is **On**, will modify the Global Center Frequency.

When **Global Center Freq** is turned **Off**, the Center Freq of the current mode is unchanged, but now the Center Freq of each mode is once again independent.

When **Mode Preset** is pressed while **Global Center Freq** is **On**, the Global Center Freq is preset to the preset Center Freq of the current mode.

This function is reset to Off when the Restore Defaults key is pressed in the Global Settings menu, or when **System, Restore Defaults, All Modes** is pressed.

Key Path:	Mode Setup, Global Settings
Scope:	Mode Global
Remote Command:	:INSTrument:COUPle:FREQUency:CENTer ALL NONE :INSTrument:COUPle:FREQUency:CENTer?
Example:	INST:COUP:FREQ:CENT ALL INST:COUP:FREQ:CENT?
Preset:	Set to Off on Global Settings, Restore Defaults and System, Restore Defaults, All Modes
Range:	On Off
Initial S/W Revision:	Prior to A.02.00
Help Map ID:	4009

Remote Command:	:GLOBal:FREQUency:CENTer[:STATe] 1 0 ON OFF :GLOBal:FREQUency:CENTer[:STATe]?
------------------------	--

Common Measurement Functions 1

Preset:	Off
Initial S/W Revision:	Prior to A.02.00
Help Map ID:	0

Restore Defaults

This key resets all of the functions in the Global Settings menu to Off. This also occurs when System, Restore Defaults, All Modes is pressed.

Key Path:	Mode Setup, Global Settings
Remote Command:	:INSTrument:COUPle:DEFault
Example:	INST:COUP:DEF
Backwards Compatibility SCPI:	:GLOBal:DEFault
Initial S/W Revision:	Prior to A.02.00
Help Map ID:	4010

Mode Setup

The Mode Setup menu contains setup functions that are global across the entire Mode. These functions are independent of which measurement is currently running - they are global to all measurements in the mode, or "Meas Global." The Mode Setup functions are not the only Meas Global functions in the test set; for example, the Trigger Setup functions are Meas Global, and there are even Mode Global functions (that is, the same for all Modes) in the Input/Output menu, but the fact that they are all Meas Global is a distinguishing characteristic of the Mode Setup functions.

The Mode Setup menu also contains the **Restore Mode Defaults** key. Most Meas Global functions are restored to their preset values by **Mode Preset**, however some variables are more persistent and are not preset until the **Restore Mode Defaults** key is pressed.

There are also a few Meas Global variables (for example, Global Center Frequency) that can be switched to be Mode Global, that is, the same for all modes. The keys under the Global Settings key control whether these variables are Mode Global or not.

Key Path	Front-panel key
Initial S/W Revision	Prior to A.02.00
Help Map ID	28881

Direction

Enables you to set the Direction of the signal being measured. The Sync/Format, Chan Profile, Time and Advanced menus will all change based on the link direction selected. Also, since downlink and uplink signals use OFDMA and SC-FDMA respectively, the list of trace results available and the default traces

presented will also change based on the link direction parameter.

Key Path:	Mode Setup
Mode:	LTE
Remote Command:	[:SENSE] :RADio:STANdard:DIRection DLINK ULINK [:SENSE] :RADio:STANdard:DIRection?
Example:	RAD:STAN:DIR DLIN
Couplings:	Changes in Direction affect many other modulation analysis setup parameters
Preset:	DLIN
State Saved:	Saved in instrument state.
Range:	Downlink Uplink
Initial S/W Revision:	Prior to A.02.00
Help Map ID:	28882

Demod

Accesses a menu that enables you to select parameters used in demodulation measurements.

Key Path:	Mode setup
Initial S/W Revision:	Prior to A.02.00
Help Map ID:	28891

Bandwidth

Enables you to set the LTE signal bandwidth (which also determines the total number of resource blocks for Modulation Analysis measurement).

Key Path:	Mode Setup, Demod
Mode:	LTE
Remote Command:	[:SENSE] :RADio:STANdard:BANDwidth B1M4 B3M B5M B10M B15M B20M [:SENSE] :RADio:STANdard:BANDwidth?
Example:	RAD:STAN:BAND B5M
Preset:	B5M
State Saved:	Saved in instrument state.
Range:	1.4 MHz (6 RB) 3 MHz (15 RB) 5 MHz (25 RB) 10 MHz (50 RB) 15 MHz (75 RB) 20 MHz (100 RB)
Initial S/W Revision:	Prior to A.02.00

Common Measurement Functions 1

Modified at S/W Revision:	A.03.00
Help Map ID:	28883

Spectrum

Determines if the spectrum of the incoming data is mirrored or not. The actual mirroring is accomplished by conjugating the complex time data.

Note that only the Modulation Analysis measurement and Conformance EVM measurement support this feature.

Key Path:	Mode Setup, Demod
Mode:	LTE
Remote Command:	[:SENSE] :SPECTrum NORMal INVert [:SENSe] :SPECTrum?
Example:	SPEC INV SPEC?
Preset:	NORM
State Saved:	Saved in instrument state.
Range:	Normal Invert
Initial S/W Revision:	Prior to A.02.00
Modified at S/W Revision:	A.03.00
Help Map ID:	28897

Fixed Equalization

Enables you to apply a fixed FIR equalization filter to the time data, before it is used in further analysis. You define the filter by its frequency response rather than by its impulse response. The frequency response must be stored in a data register.

Note that only the Modulation Analysis measurement supports this feature.

Key Path:	Mode Setup, Demod
Mode:	LTE
Initial S/W Revision:	Prior to A.02.00
Help Map ID:	28898

Fixed EQ Mode

Enables you to turn fixed equalization off, on in normal mode, or on in inverted mode. The effect of Normal mode is to divide the spectrum of the unequalized data by the frequency response in the data register. Invert mode

multiplies instead of divides.

Key Path:	Mode Setup, Demod, Fixed Equalization
Mode:	LTE
Remote Command:	[:SENSE] :CORRection:FEQualizer OFF NORMal INVert [:SENSE] :CORRection:FEQualizer?
Example:	CORR:FEQ NORM CORR:FEQ?
Preset:	OFF
State Saved:	Saved in instrument state.
Range:	Off Normal Invert
Initial S/W Revision:	Prior to A.02.00
Modified at S/W Revision:	A.03.00
Help Map ID:	28888

Freq Response Register

Enables you to choose a register that contains the frequency response information for fixed equalization.

Key Path:	Mode Setup, Demod, Fixed Equalization
Mode:	LTE
Remote Command:	[:SENSE] :CORRection:FEQualizer:REGister D1 D2 D3 D4 D5 D6 [:SENSE] :CORRection:FEQualizer:REGister?
Example:	CORR:FEQ:REG D2 CORR:FEQ:REG?
Preset:	D1
State Saved:	Saved in instrument state.
Range:	Data 1 Data 2 Data 3 Data 4 Data 5 Data 6
Initial S/W Revision:	Prior to A.02.00
Modified at S/W Revision:	A.03.00
Help Map ID:	28899

Preset to Standard

Sets the parameters to the LTE standard preset.

Key Path:	Mode Setup
-----------	-------------------

Common Measurement Functions 1

Mode:	LTE
Remote Command:	[:SENSe] :RADio:STANdard:PRESet B1M4 B3M B5M B10M B15M B20M
Example:	RAD:STAN:PRES B5M
Couplings:	Preset To Standard presets parameter values
Preset:	B5M
State Saved:	Saved in instrument state.
Range:	1.4 MHz (6 RB) 3 MHz (15 RB) 5 MHz (25 RB) 10 MHz (50 RB) 15 MHz (75 RB) 20 MHz (100 RB)
Initial S/W Revision:	Prior to A.02.00
Modified at S/W Revision:	A.03.00
Help Map ID:	28900

Restore Mode Defaults

Resets the state for the currently active mode by resetting the mode persistent settings to their factory default values, clearing mode data, and performing a Mode Preset

For more information, see [Restore Mode Defaults@2307@i](#).

Key Path:	Mode setup
Initial S/W Revision:	Prior to A.02.00
Help Map ID:	28885

Global Settings

See [Global Settings@4003@i](#) for details.

Global Center Freq

See [Global Center Freq@4009@i](#) for details.

Restore Defaults

See [Restore Defaults@4010@i](#) for details.

Peak Search

Pressing the Peak Search key displays the Peak Search menu and places the selected marker on the trace point with the maximum y-axis value for that marker's trace. The Peak Search features allow you to define specific search criteria to determine which signals can be considered peaks, excluding unwanted signals from the search.

See “More Information” on page 1471.

Remote Command:	:CALCulate:MARKer [1] 2 3 4 5 6 7 8 9 10 11 12 :MAXimum
Example:	CALC:MARK2:MAX performs a peak search using marker 2. CALC:MARK2:Y? queries the marker amplitude (Y-axis) value for marker 2. CALC:MARK2:X? queries the marker frequency or time (X-axis) value for marker 2. SYST:ERR? can be used to query the errors to determine if a peak is found. The error –200 is returned after an unsuccessful search.
Notes:	Sending this command selects the subopcoded marker.
Initial S/W Revision:	Prior to A.02.00
Help Map ID:	3233

More Information

If **Same as “Next Peak” Criteria** is selected, and either **Pk Excursion** or **Pk Threshold** are on, a signal must meet those criteria. If no valid peak is found, a message is generated. And then the marker is not moved. When **Highest Peak** is on, or both **Pk Excursion** and **Pk Threshold** are off, the marker is always placed at the point on the trace with the maximum y-axis value, even if that point is on the very edge of the trace (exception: negative frequencies and signals close to the LO are not searched at all).

Pressing Peak Search with the selected marker off causes the selected marker to be set to **Normal** at the center of the screen, then a peak search is immediately performed.

Pressing the front panel Peak Search key always does a peak search. Occasionally, you may need to get to the Peak Search menu key functions without doing a peak search. You can do this by first accessing the Peak Search menu. Then go to the other menus that you need to access. Finally, you can get back to the Peak Search key menu by using the front panel Return key and pressing it as many times as required to navigate back through the previously accessed menus until you get back to the Peak Search menu.

Next Peak

Pressing Next Peak moves the selected marker to the peak that has the next highest amplitude less than the marker’s current value. Only peaks which meet all enabled peak criteria are considered. If there is no valid peak lower than the current marker position, an error is generated and the marker is not moved.

If the selected marker was off, then it is turned on as a normal marker and a peak search is performed.

Key Path	Peak Search
Remote Command	:CALCulate:MARKer [1] 2 3 4 5 6 7 8 9 10 11 12 :MAXimum:NEXT
Example	CALC:MARK2:MAX:NEXT Selects marker 2 and moves it to the peak that is closest in amplitude to the current peak, but the next lower value.
Notes	Sending this command selects the subopcoded marker.
State Saved	Not part of saved state.

Common Measurement Functions 1

Initial S/W Revision	Prior to A.02.00
Help Map ID	3234

Next Pk Right

Pressing Next Pk Right moves the selected marker to the nearest peak right of the current marker which meets all enabled peak criteria. If there is no valid peak to the right of the current marker position, an error is generated and the marker is not moved.

If the selected marker was off, then it is turned on as a normal marker and a peak search is performed.

Key Path	Peak Search
Remote Command	:CALCulate:MARKer [1] 2 3 4 5 6 7 8 9 10 11 12 :MAXimum:RIGht
Example	CALC:MARK2:MAX:RIGH Selects marker 2 and moves it to the next peak to the right of the current marker position.
Notes	Sending this command selects the subcoded marker.
State Saved	Not part of saved state.
Initial S/W Revision	Prior to A.02.00
Help Map ID	3235

Next Pk Left

Pressing Next Pk Left moves the selected marker to the nearest peak left of the current marker which meets all enabled peak criteria. If there is no valid peak to the left of the current marker position, an error is generated and the marker is not moved.

If the selected marker was off, then it is turned on as a normal marker and a peak search is performed.

Key Path	Peak Search
Remote Command	:CALCulate:MARKer [1] 2 3 4 5 6 7 8 9 10 11 12 :MAXimum:LEFT
Example	CALC:MARK2:MAX:LEFT selects marker 2 and moves it to the next peak to the left of the current marker position.
State Saved	Not part of saved state.
Initial S/W Revision	Prior to A.02.00
Help Map ID	3236

Marker Delta

Performs the same function as the Delta 1-of-N selection key in the Marker menu. Basically this sets the control mode for the selected marker to Delta mode. See the Section [“Marker” on page 1449](#) for the complete description of this function. The key is duplicated here in the Peak Search Menu to allow you to conveniently perform a peak search and change the marker’s control mode to Delta without having to

access two separate menus.

Initial S/W Revision	Prior to A.02.00
Key Path	Peak Search or Marker
Notes	Whenever the selected marker is in Delta mode and you are in the Peak Search menu, the Marker Delta key should be highlighted and the active function for setting its delta value turned on.
Help Map ID	3237

Mkr->CF

Assigns the selected marker’s frequency to the Center Frequency setting. See the Section ““[Marker To](#)” on page 1489” for the description of this function. The key is duplicated here in the Peak Search Menu to allow you to conveniently perform a peak search and marker to CF without having to access two separate menus.

Key Path	Peak Search or Marker ->
Dependencies	Same as specified under Marker To
Initial S/W Revision	Prior to A.02.00
Help Map ID	3238

Mkr->Ref Lvl

Assigns the selected marker’s level to the Reference Level setting. See the Section ““[Marker To](#)” on page 1489” for the description of this function. The key is duplicated here in the Peak Search Menu to allow you to conveniently perform a peak search and marker to RL without having to access two separate menus.

Key Path	Peak Search or Marker ->
Dependencies	Same as specified under Marker To
Initial S/W Revision	Prior to A.02.00
Help Map ID	3239

Peak Criteria

Pressing this key opens the Peak Criteria menu and allows you to adjust the Pk Threshold and Pk Excursion parameters used for peak search functions.

For a signal to be identified as a peak it must meet certain criteria. Signals in the negative frequency range and signals very close to 0 Hz are ignored. If either the peak excursion or peak threshold functions are on, then the signal must satisfy those criteria before being identified as a peak.

When peak excursion and peak threshold are both off:

Peak Search, Continuous Peak Search, and maximum part of **Pk-Pk Search** will search the trace for the point with the highest y-axis value which does not violate the LO feed through rules. A rising and

Common Measurement Functions 1

falling slope are not required for these three peak search functions.

The remaining search functions **Next Peak**, **Next Pk Right**, et cetera will only consider trace points which have a rising and falling slope on the left and right respectively.

Key Path	Peak Search
Initial S/W Revision	Prior to A.02.00
Help Map ID	3240

“Peak Search” Criteria

This menu lets you decide what kind of search you want to do when the Peak Search key is pressed (or the equivalent SCPI command sent).

Note that there are two “types” of peak search functions. One type is the “Peak Search” type, the other type is the “Next Peak” type. “Next Peak” searches (for example, Next Peak, Next Pk Left, Next Pk Right) are always checked using the Excursion and Threshold criteria as long as these criteria are On. The “Peak Search” type of search, simply finds the highest point on the trace. However you can change the “Peak Search” type of search so that it also uses the Excursion and Threshold criteria. This allows you to find the Maximum point on the trace that also obeys the Excursion and/or Threshold criteria.

When **Highest Peak** is selected, pressing **Peak Search** simply finds the highest peak on the marker’s trace. If **Same as “Next Peak” Criteria** is selected, then the search is also forced to consider the Excursion and Threshold found under the “**Next Peak**” **Criteria** menu.

Key Path	Peak Search, Peak Criteria
Remote Command	:CALCulate:MARKer:PEAK:SEARch:MODE MAXimum PARAmeter :CALCulate:MARKer:PEAK:SEARch:MODE?
Notes	MAXimum corresponds to the Highest Peak setting PARAmeter corresponds to the Same as “Next Peak” Criteria setting
Preset	MAXimum
State Saved	Saved in instrument state.
Readback line	Current state
Initial S/W Revision	Prior to A.02.00
Help Map ID	3241

Highest Peak

When this key is selected, pressing the Peak Search key or issuing the equivalent SCPI command finds the maximum point on the trace, subject to the peak-search qualifications. This also affects the Peak Search half of Pk-Pk search and the Continuous Peak Search.

Key Path	Peak Search, Peak Criteria, “Peak Search” Criteria
----------	---

Example	CALC:MARK:PEAK:SEAR:MODE MAX
Readback	Highest Peak
Initial S/W Revision	Prior to A.02.00
Help Map ID	3242

Same as “Next Peak” Criteria

When this key is selected, pressing the Peak Search key or issuing the equivalent SCPI command finds the maximum point on the trace, but subject to the Excursion and Threshold set under the Next Peak Criteria menu. The search is, of course, also subject to the peak-search qualifications. This also affects the Peak Search half of Pk-Pk search and the Continuous Peak Search.

Key Path	Peak Search, Peak Criteria, “Peak Search” Criteria
Example	CALC:MARK:PEAK:SEAR:MODE PAR
Readback	Use Excurs & Thr
Initial S/W Revision	Prior to A.02.00
Help Map ID	3243

“Next Peak” Criteria

This key opens up a menu which allows you to independently set the Peak Excursion and Peak Threshold and turn them on and off.

Key Path	Peak Search, Peak Criteria
Initial S/W Revision	Prior to A.02.00
Help Map ID	3244

Pk Excursion On/Off

Turns the peak excursion requirement on/off and sets the excursion value. The value defines the minimum amplitude variation (rise and fall) required for a signal to be identified as peak. For example, if a value of 6 dB is selected, peak search functions like the marker Next Pk Right function move only to peaks that rise and fall 6 dB or more.

When both Pk Excursion and Pk Threshold are on, a signal must rise above the Pk Threshold value by at least the **Peak Excursion** value and then fall back from its local maximum by at least the **Peak Excursion** value to be considered a peak.

NOTE In the event that a sequence of trace points with precisely the same values represents the maximum, the leftmost point is found.

See [“More Information” on page 1476](#).

Key Path	Peak Search, Peak Criteria, “Next Peak” Criteria
----------	---

Common Measurement Functions 1

Remote Command	:CALCulate:MARKer:PEAK:EXCursion <rel_ampl> :CALCulate:MARKer:PEAK:EXCursion? :CALCulate:MARKer:PEAK:EXCursion:STATE OFF ON 0 1 :CALCulate:MARKer:PEAK:EXCursion:STATE?
Example	:CALC:MARK:PEAK:EXC:STAT ON :CALC:MARK:PEAK:EXC 30 DB sets the minimum peak excursion requirement to 30 dB
Dependencies	Available only when Y axis unit is amplitude units, otherwise grayed out.
Couplings	Whenever you adjust the value of Pk Excursion (with the knob, step keys, or by completing a numeric entry), and Peak Threshold is turned ON, the Peak Threshold Line and the Peak Excursion Region are displayed.
Preset	6.0 dB ON
Preset	6.0 dB ON
State Saved	Saved in State
Min	0.0 dB
Max	100.0 dB
Initial S/W Revision	Prior to A.02.00
Help Map ID	3245

More Information

If two signals are very close together and the peak excursion and threshold criteria are met at the outside edges of the combined signals, this function finds the highest of these two signals as a peak (or next peak). However, if a signal appears near the edge of the screen such that the full extent of either the rising or falling edge cannot be determined, and the portion that is on screen does not meet the excursion criteria, then the signal cannot be identified as a peak.

When measuring signals near the noise floor, you can reduce the excursion value even further to make these signals recognizable. To prevent the marker from identifying noise as signals, reduce the noise floor variations to a value less than the peak-excursion value by reducing the video bandwidth or by using trace averaging.

Pk Threshold On/Off

Turns the peak threshold requirement on/off and sets the threshold value. The peak threshold value defines the minimum signal level (or min threshold) that the peak identification algorithm uses to recognize a peak.

When both Pk Excursion and Pk Threshold are on, a signal must rise above the Pk Threshold value by at least the **Peak Excursion** value and then fall back from its local maximum by at least the **Peak Excursion** value to be considered a peak.

For example, if a threshold value of -90 dBm is selected, the peak search algorithm will only consider signals with amplitude greater than the -90 dBm threshold. If a threshold value of -90 dBm is selected, and **Peak Excursion** is **On** and set to 6 dB, the peak search algorithm will only consider signals with amplitude greater than the -90 dBm

threshold which rise 6 dB above the threshold and then fall back to the threshold.

Key Path	Peak Search, Peak Criteria, "Next Peak Criteria"
Remote Command	:CALCulate:MARKer:PEAK:THReshold <ampl> :CALCulate:MARKer:PEAK:THReshold? :CALCulate:MARKer:PEAK:THReshold:STATe OFF ON 0 1 :CALCulate:MARKer:PEAK:THReshold:STATe?
Example	CALC:MARK:PEAK:THR:STAT ON turns on the threshold criterion. CALC:MARK:PEAK:THR -60 dBm sets the threshold to -60 dBm.
Dependencies	When Ref Level Offset changes, Peak Threshold must change by the same amount.
Preset	-90.0 dBm ON
State Saved	Saved in instrument state.
Min	The current displayed Ref Level - 200 dB. The current displayed Ref Level is the current Ref Level, offset by the Ref Level Offset.
Max	The current displayed Ref Level. This means the current Ref Level, offset by the Ref Level Offset.
Default Unit	depends on the current selected Y axis unit
Initial S/W Revision	Prior to A.02.00
Help Map ID	3246

Pk Threshold Line On/Off

Turns the peak threshold line on or off. Preset state is off. No equivalent SCPI command.

See ["More Information" on page 1477](#).

Dependencies	If Peak Threshold is Off and the Peak Threshold line is turned on, it should turn on Peak Threshold.
Initial S/W Revision	Prior to A.02.00
Help Map ID	3814

More Information

The Peak Threshold line is green and has the value of the peak threshold (for example, "-20.3 dBm") written above its right side, above the line itself. If Peak Excursion is ON it shows on the left side as a region above the Peak Threshold line. As with all such lines (Display Line, Trigger Level line, et cetera) it is drawn on top of all traces.

Common Measurement Functions 1

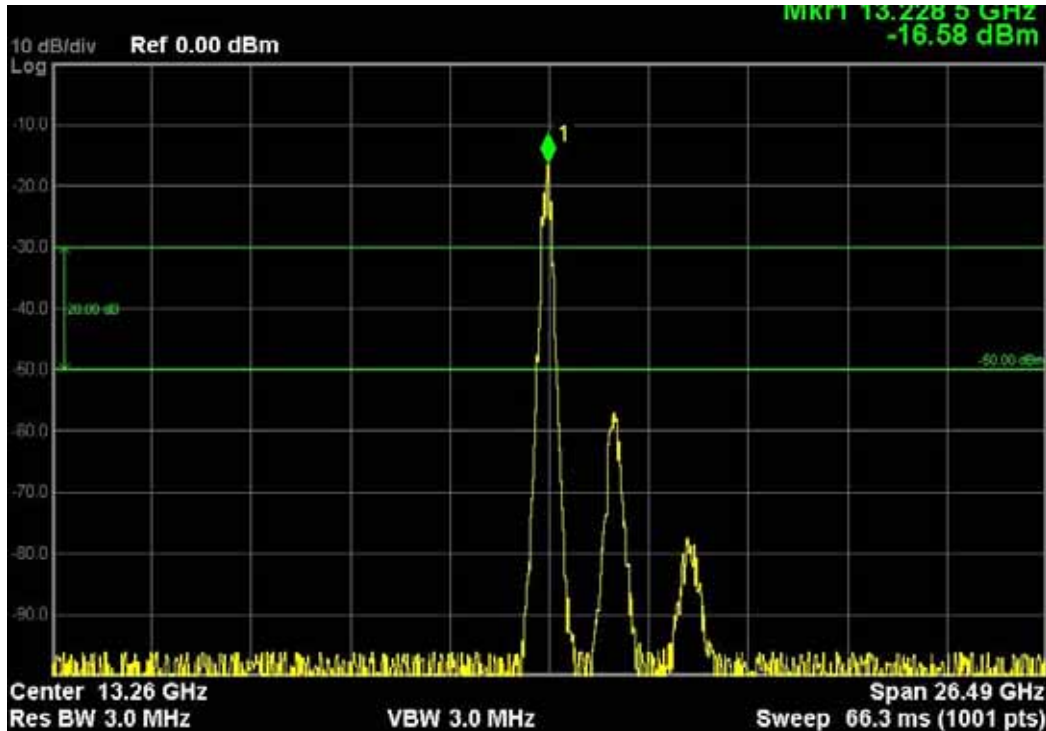

This function is automatically set to ON (thus turning on the Peak Threshold line) whenever the value of Peak Threshold or Peak Excursion becomes the active function, unless Peak Threshold is OFF. It is automatically set to OFF whenever Peak Threshold is set to OFF. Manually turning it ON automatically turns on Pk Threshold.

The Peak Excursion part is on whenever the Pk Threshold part is on, unless Peak Excursion is OFF.

Peak Table

Opens the Peak Table menu.

The Peak Table provides a displayed list of up to 20 signal peaks from the selected trace. If more than one trace window is displayed, the selected trace in the selected window is used. If there are more than 20 signals which meet the peak search criteria, only the 20 highest peaks are listed.

The Peak Table is updated after each sweep. The list of peaks in the Peak Table can be ordered either by ascending frequency or by descending amplitude. In either case, the entire trace is first evaluated and the 20 highest peaks are selected for inclusion in the list. After the peaks are selected, they are then sorted and displayed according to the Peak Sort setting.

Key Path	Peak Search
Initial S/W Revision	Prior to A.02.00
Help Map ID	3247

Peak Table On/Off

Turns Peak Table on/off. When turned on, the display is split into a measurement window and a peak table display window.

Turning the Peak Table on turns the Marker Table off and vice versa.

Key Path	Peak Search, Peak Table
Remote Command	:CALCulate:MARKer:PEAK:TABLE:STATe OFF ON 0 1 :CALCulate:MARKer:PEAK:TABLE:STATe?
Example	CALC:MARK:PEAK:TABL:STAT ON Turns on and displays the peak table.
Dependencies	When the Peak Table turns on, if Peak Threshold is On then it becomes the active function.
Preset	OFF
State Saved	Saved in instrument state.
Initial S/W Revision	Prior to A.02.00
Help Map ID	3248

Peak Sort

Sets the peak table sorting routine to list the peaks in order of descending amplitude or ascending frequency. The remote command can also be used to sort the peaks found using the :CALCulate:DATA:PEAKs command.

Key Path	Peak Search, Peak Table
Remote Command	:CALCulate:MARKer:PEAK:SORT FREQuency AMPLitude :CALCulate:MARKer:PEAK:SORT?
Example	CALC:MARK:PEAK:SORT AMPL Sets sorting routine to list peaks in order of descending amplitude. CALC:MARK:PEAK:SORT?
Preset	AMPLitude
Preset	AMPLitude
State Saved	Saved in instrument state.
Backwards Compatibility SCPI	:TRACe:MATH:PEAK:SORT
Backwards Compatibility SCPI	The old TRAC:MATH:PEAK:SORT command/query used in ESA is still supported for backward compatibility.
Initial S/W Revision	Prior to A.02.00
Help Map ID	3249

Peak Readout

Shows up to twenty signal peaks as defined by the setting:

All (ALL) - lists all the peaks defined by the peak criteria, in the current sort setting.

Above Display Line (GTDLIne) - lists the peaks that are greater than the defined display line, and that

Common Measurement Functions 1

meet the peak criteria. They are listed in the current sort order.

Below Display Line (LTDLine) - lists the peaks that are less than the defined display line, and that meet the peak criteria. They are listed in the current sort order.

If the peak threshold is defined and turned on, then the peaks must meet this peak criteria in addition to the display line requirements.

See “More Information” on page 1480.

Key Path	Peak Search, Peak Table
Remote Command	:CALCulate:MARKer:PEAK:TABLE:READout ALL GTDLine LTDLine :CALCulate:MARKer:PEAK:TABLE:READout?
Example	CALC:MARK:PEAK:TABL:READ GTDL
Dependencies	Turning Display Line off forces Readout to ALL
Preset	All
Preset	All
State Saved	Saved in instrument state.
Readback line	1-of-N selection
Initial S/W Revision	Prior to A.02.00
Help Map ID	3250

More Information

If the Display Line (see the Section “View/Display”) is turned on, the Peak Table can be selected to include all peaks, only those above the Display Line, or only those below the Display Line. See Figures 1-2 and 1-3 to understand what happens if both Display Line and Pk Threshold are turned on.

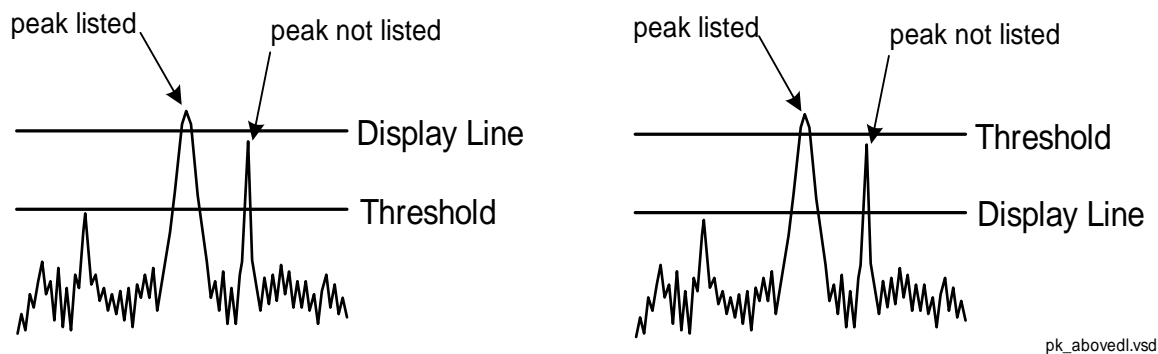

Figure 1- 2Above Display Line Peak Identification

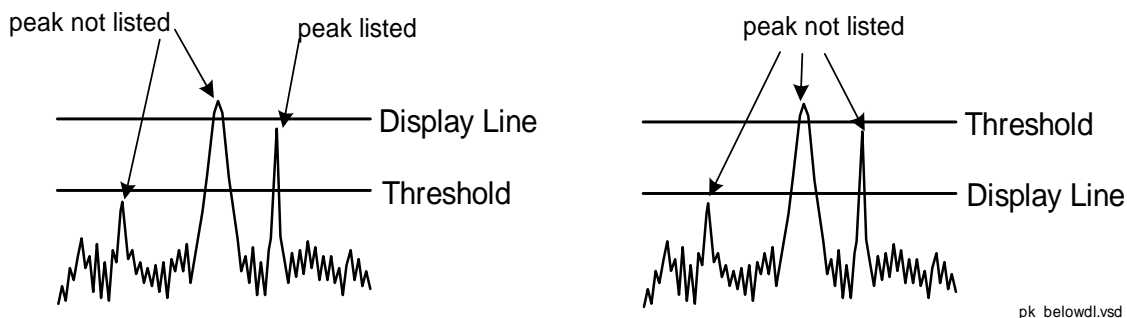

Figure 1- 3Below Display Line Peak Identification

All

Sets the peak table to display the 20 highest peaks in the order specified by the current Peak Sort setting. If the Peak Criteria are turned on, then only peaks that meet the defined Pk Excursion and Pk Threshold values are found.

Key Path	Peak Search, Peak Table, Peak Readout
Example	CALC:MARK:PEAK:TABL:READ ALL
Notes	Auto return after pressed
Readback	All
Initial S/W Revision	Prior to A.02.00
Help Map ID	3251

Above Display Line

Sets the peak table to display only the 20 highest peaks above the display line in the order specified by the current Sort setting. If the Peak Criteria are turned on, then only peaks that meet the defined criteria are found. If the display line is not already on, it is turned on (it has to be on or it cannot be used to exclude peaks).

Key Path	Peak Search, Peak Table, Peak Readout
Example	CALC:MARK:PEAK:TABL:READ GTDL
Notes	Auto return after pressed
Dependencies	When Above Display Line is selected, Display Line is turned on and becomes the active function.
Readback	Above DL
Initial S/W Revision	Prior to A.02.00
Help Map ID	3252

Below Display Line

Sets the peak table to display only the 20 highest peaks below the display line as defined by the peak in the order

Common Measurement Functions 1

specified by the current Sort setting. If the Peak Criteria are turned on, then only peaks that meet the defined criteria are found. If the display line is not already on, it is turned on (it has to be on or it cannot be used to exclude peaks).

Key Path	Peak Search, Peak Table, Peak Readout
Example	CALC:MARK:PEAK:TABL:READ LTDL
Notes	Auto return after pressed
Dependencies	When Below Display Line is selected, Display Line is turned on and becomes the active function.
Readback	Below DL
Initial S/W Revision	Prior to A.02.00
Help Map ID	3253

Continuous Peak Search On/Off

Turns Continuous Peak Search on or off. When Continuous Peak Search is on, a peak search is automatically performed for the selected marker after each sweep. The rules for finding the peak are exactly the same as for **Peak Search**, including the use of the peak criteria rules. If no valid peak is found, a warning is generated after each sweep.

See [“More Information” on page 1483](#).

Key Path	Peak Search
Remote Command	:CALCulate:MARKer [1] 2 3 4 5 6 7 8 9 10 11 12 :CPSearch [:STATE] ON OFF 1 0 :CALCulate:MARKer [1] 2 3 4 5 6 7 8 9 10 11 12 :CPSearch [:STATE] ?
Example	CALC:MARK:CPS ON Turns on Continuous Peak Search.
Notes	Sending this command selects the subcoded marker
Couplings	The Continuous Peak Search key is grayed out when the selected marker is a Fixed marker. Also, if Continuous Peak Search is on and the selected marker becomes a fixed marker, then Continuous Peak Search is turned off and the key grayed out. Signal Track and Continuous Peak Search are mutually exclusive so if Signal Track is on, Continuous Peak Search is grayed out and vice versa.
Preset	Mode Preset
State Saved	Saved in instrument state.
Status Bits/OPC dependencies	The Measuring bit should remain set while this command is operating and should not go false until the marker position has been updated.
Initial S/W Revision	Prior to A.02.00
Help Map ID	3254

More Information

When Continuous Peak Search is turned on a peak search is immediately performed and then is repeated after each sweep. If Continuous Peak Search is turned on with the selected marker off, the selected marker is set to **Normal** at the center of the screen, and then a peak search is immediately performed and subsequently repeated after each sweep.

When in Continuous Peak Search, *OPC will not return true, nor will READ or MEASure return any data, until the sweep is complete and the marker has been re-peaked. Note further that if the test set is in a measurement such as averaging, and Continuous Peak Search is on, the entire measurement is allowed to complete (i.e., all the averages taken up to the average number) before the repeak takes place, and only THEN will *OPC go true and READ or MEASure return data.

When Continuous Peak Search is turned on for a marker, a little “hat” is placed above the marker.

Pk-Pk Search

Finds and displays the amplitude and frequency (or time, if in zero span) differences between the highest and lowest y-axis value. It places the selected marker on the minimum value on its selected trace. And it places that marker’s reference marker on the peak of its selected trace. This function turns on the reference marker and sets its mode to **Fixed** if it is not already on. (These markers may be on two different traces.)

The rules for finding the maximum peak are exactly the same as for **Peak Search**, including the use of the peak criteria rules. However, the minimum trace value is not required to meet any criteria other than being the minimum y-axis value in the trace.

When Pk-Pk Search is successful, a message is displayed on the message line.

If the selected marker is off, a delta type marker is turned on and the peak-to-peak search is done. If the selected marker is on, but it is not a delta marker, then it is changed to delta which turns on the reference marker if needed, and then it performs the peak-to-peak function.

Key Path	Peak Search
Remote Command	:CALCulate:MARKer [1] 2 3 4 5 6 7 8 9 10 11 12 :PTPeak
Example	CALC:MARK:PTP CALC:MARK:Y? queries the delta amplitude value for marker 1.
Notes	Turns on the Marker Δ active function.
Notes	Sending this command selects the subcoded marker.
Dependencies	Pk-Pk Search is grayed out when Coupled Markers is on.
Couplings	The selected marker becomes a delta marker if not already in delta mode.
State Saved	Not part of saved state.
Initial S/W Revision	Prior to A.02.00
Help Map ID	3255

Common Measurement Functions 1

Min Search

Moves the selected marker to the minimum y-axis value on the current trace. Minimum (negative) peak searches do not have to meet the peak search criteria. It just looks for the lowest y-axis value. If the selected marker is Off, it is turned on before the minimum search is performed.

Key Path	Peak Search
Remote Command	:CALCulate:MARKer [1] 2 3 4 5 6 7 8 9 10 11 12 :MINimum
Example	CALC:MARK:MIN selects marker 1 and moves it to the minimum amplitude value.
Notes	Sending this command selects the subcoded marker.
State Saved	Not part of saved state.
Initial S/W Revision	Prior to A.02.00
Help Map ID	3256

Recall

In the LTE FDD mode, four types of recall functions are available under the Data menu: “Limit Mask”, “E-UTRA Test Model”, “Signal Studio Setup”, and “Vector Signal Analyzer”. “Limit Mask” enables setting of a preset limit mask for Power Suite-based measurements, and currently it is available for the SEM/ACP measurements with the LTE FDD mode. Recalling “E-UTRA Test Model” sets complicated RB settings for each Test Model for the Modulation Analysis and Conformance EVM measurements. Recalling “Signal Studio Setup” or “89600 Vector Signal Analyzer” enables you to recall parameters which have been set and saved on the external platform.

Key Path:	Front Panel
Mode:	LTEFDD
Initial S/W Revision:	Prior to A.02.00
Modified at S/W Revision:	A.06.00
Help Map ID:	28892

State

See State@2638@i for more information.

Data

See Data@2648@i for more information.

Import Trace Data

See Import Trace Data@30195@i for more information.

Signal Studio Setup

This key allows you to recall the Agilent Signal Studio setup file created on the Signal Studio (N7625B).

This key is valid only for the Mod Analysis measurement. For E-TM test model signal, please use corresponding EVM setup file under My Documents\LTEFDD\data\evmsetup.

For the supported carrier types, see the table below.

Signal Studio	Carrier Type
N7624B Signal Studio for 3GPP LTE FDD	Advanced LTE FDD(2009-03)
	Advanced LTE FDD(2009-12)
	Basic LTE FDD(2009-03)
	Basic LTE FDD(2009-12)

File Location and Extension

File location: “My Documents\LTEFDD\data”

File type: xml

File extension: .scp

You need to place the Signal Studio Setup file created on N7625B in the above directory in advance. Pressing **OPEN** under the Import Data menu will open this directory from which you can select the setup file.

Example:

File Location: My Documents\LTEFDD\data

File Name: Uplink PRACH.scp

Key Path:	Recall, Data
Mode:	LTEFDD
Remote Command:	:MMEMory:LOAD:SSSetup <string>
Example:	MMEM:LOAD:SSS "Uplink PRACH.scp"
Notes:	Sets of parameters related to Signal Studio Setup are overwritten by the contents of the setup file.
Initial S/W Revision:	A.06.00
Help Map ID:	28893

89601 VSA Setup

Enables you to import the 89600 Vector Signal Analyzer Setup file created using the 89600 Vector Signal Analyzer Option BHE (LTE FDD). This key is valid only for the Mod Analysis measurement.

File Location and Extension

File location: “My Documents\LTEFDD\data”

File type: text file

Common Measurement Functions 1

File extension: .set, .setx

Place the 89600 Vector Signal Analyzer Setup file that you saved on 89600 in the above directory. When you select **OPEN** under the Import Data menu, the directory opens enabling you to select your setup file.

Example:

File Location: My Documents\LTEFDD\data

File Name: Uplink PRACH.set

Key Path:	Recall, Data
Mode:	LTEFDD
Remote Command:	:MMEMory:LOAD:VSASetup <string>
Example:	MMEM:LOAD:VSAS "Uplink PRACH.set"
Notes:	Sets of parameters related to Vector Signal Analyzer Setup are overwritten by the contents of the setup file.
Initial S/W Revision:	A.06.00
Modified at S/W Revision:	A.10.00
Help Map ID:	28894

Masks

This key allows you to recall a preset mask file from the list. The preset mask file contains configuration for only Carrier, Offset, Limit settings, and the preset profile BW. Any set of values not specified by the preset mask file will not be overwritten.

You cannot change or create the preset mask file since it is a binary file. This key is valid for the Spectrum Emission Mask and ACP measurements.

File location: "My Documents\LTEFDD\data.masks"

Note that "My Documents" is an alias to a directory and its place differs depending on which user is logged in. At XSA start up, XSA will overwrite all of the limit mask files to the current user's "My Documents\LTEFDD\data.masks" each time.

File type: Binary

Filename: The filename follows the rule below, in which the word is connected with underscores.

<Measurement>_<Direction>_<Bandwidth>_<Condition>.mask

Where

<Measurement> Measurement the limit mask file is applied to: SEM or ACP

<Direction> Direction: BS (Downlink) or MS (Uplink).

<Bandwidth> Bandwidth

<Condition> Condition. It depends on the measurement.

File extension: .mask

Pressing **OPEN** under the Import Data menu will open the above directory from which you can select a mask file. When you change the Bandwidth or Direction, all Power Suite measurement parameters are reset to the hard coded preset parameters. Thus you must recall the appropriate preset mask file again after the change.

You cannot read the contents of the provided pre-set mask file since it is a binary file. Detailed contents of the file are provided by a PDF format file located in the same directory as the pre-set mask file.

Example:

File Location: My Documents/LTEFDD/data/masks/SEM_MS

File Name: SEM_MS_15MHz_Add_NS04.mask

The following table shows the sets of variables imported to the ACP measurement.

Offset	Start Freq (MHz)	Stop Freq (MHz)	Res BW (Hz)	Meas BW	Rel Start	Rel Stop	Fail Mask
A	5	7.14	30k	1	-8	-25	Rel
B	7.14	10.57	30k	1	-25	-27	Rel
C	10.57	20	30k	1	-27	-50	Rel
D	20	25	30k	1	-50	-50	Rel
E	25	30	30k	1	-50	-50	Rel

Key Path:	Recall, Data
Mode:	LTEFDD
Remote Command:	:MMEMory:LOAD:MASK <string>
Example:	MMEM:LOAD:MASK "ACP_BS\ACP_BS_3MHz_pairE-UTRA_CatA.mask"
Notes:	Sets of parameters related to Limit, Carrier and Offset are overwritten by the contents of the preset mask file.
Initial S/W Revision:	A.03.00
Help Map ID:	28889

EVM Setup

This key allows you to recall EVM parameter setting to measure E-UTRA Test Model in 3GPP standard (36.141-810 6.1.1).

E-UTRA Test Model 1.1 (E-TM1.1)

E-UTRA Test Model 1.2 (E-TM1.2)

E-UTRA Test Model 2 (E-TM2)

Common Measurement Functions 1

E-UTRA Test Model 3.1 (E-TM3.1)

E-UTRA Test Model 3.2 (E-TM3.2)

E-UTRA Test Model 3.3 (E-TM3.3)

This key is valid for the Modulation Analysis and Conformance EVM measurements only.

File Location and Extension

File location: My Documents\LTEFDD\data\evmsetup

Note that “My Documents” is an alias to a directory and its place differs depending on which user is logged in. At XSA start up, XSA will overwrite all of the EVM Setup files to the current user’s “My Documents\LTEFDD\data\evmsetup” each time.

File type: binary

File extension: .evms

Pressing **OPEN** under the Import Data menu will open the above directory from which you can select an EVM Setup file. When you change the Bandwidth, parameters are reset to the hard coded preset parameters. Thus you must recall the appropriate EVM Setup file again after the change.

You cannot read the contents of the provided EVM Setup file since it is a binary file.

Example:

File Location: My Documents\LTEFDD\data\evmsetup

Filename: TM3.1-BW1.4MHz.evms

Key Path:	Recall, Data
Mode:	LTEFDD
Remote Command:	:MMEMory:LOAD:EVMSetup <string>
Example:	MMEM:LOAD:EVMS "TM2-BW15MHz.evms"
Notes:	Sets of parameters related to EVM Setup are overwritten by the contents of the EVM Setup file.
Initial S/W Revision:	A.03.00, A.08.00
Help Map ID:	28890

Restart

The Restart function restarts the current sweep, or measurement, or set of averaged/held sweeps or measurements. If you are Paused, pressing Restart does a Resume.

The Restart function is accessed in several ways:

- Pressing the Restart key
- Sending the remote command INIT:IMMEDIATE

- Sending the remote command INIT:REStart

Key Path:	Front-panel key
Remote Command:	:INITiate[:IMMEDIATE] :INITiate:REStart
Example:	:INIT:IMM :INIT:REST
Notes:	:INITiate:REStart and :INITiate:IMMEDIATE perform exactly the same function.
Couplings:	Resets average/hold count k. For the first sweep overwrites all active (update=on) traces with new current data. For application modes, it resets other parameters as required by the measurement.
Status Bits/OPC dependencies:	This is an Overlapped command. The STATus:OPERation register bits 0 through 8 are cleared. The STATus:QUEStionable register bit 9 (INTegrity sum) is cleared. The SWEEPING bit is set. The MEASURING bit is set.
Backwards Compatibility Notes:	For Spectrum Analysis mode in ESA and PSA, the Restart hardkey and the INITiate:REStart command restart trace averages (displayed average count reset to 1) for a trace in Clear Write , but did not restart Max Hold and Min Hold . In the X-Series, the Restart hardkey and the INITiate:REStart command restart not only Trace Average , but Max Hold and Min Hold traces as well. For wireless comms modes in ESA and PSA, the Restart hardkey and the INITiate:REStart command restart every measurement, which includes all traces and numeric results. There is no change to this operation.
Initial S/W Revision:	Prior to A.02.00
Help Map ID:	3307

The **Restart** function first aborts the current sweep/measurement as quickly as possible. It then resets the sweep and trigger systems, sets up the measurement and initiates a new data measurement sequence with a new data acquisition (sweep) taken once the trigger condition is met.

If the test set is in the process of aligning when **Restart** is executed, the alignment finishes before the restart function is performed.

Even when set for Single operation, multiple sweeps may be taken when Restart is pressed (for example, when averaging/holding is on). Thus when we say that **Restart** "restarts a measurement," we may mean:

- It restarts the current sweep
- It restarts the current measurement
- It restarts the current set of sweeps if any trace is in Trace Average, Max Hold or Min Hold

Common Measurement Functions 1

- It restarts the current set of measurements if Averaging, or Max Hold, or Min Hold is on for the measurement
- depending on the current settings.

With **Average/Hold Number** (in **Meas Setup** menu) set to 1, or Averaging off, or no trace in Trace Average or Hold, a single sweep is equivalent to a single measurement. A single sweep is taken after the trigger condition is met; and the test set stops sweeping once that sweep has completed. However, with **Average/Hold Number** >1 and at least one trace set to **Trace Average, Max Hold, or Averaging on (most other measurements)**, multiple sweeps/data acquisitions are taken for a single measurement. The trigger condition must be met prior to each sweep. The sweep is stopped when the average count k equals the number N set for **Average/Hold Number**. A measurement average usually applies to all traces, marker results, and numeric results; but sometimes it only applies to the numeric results.

Once the full set of sweeps has been taken, the test set will go to idle state. To take one more sweep without resetting the average count, increment the average count by 1, by pressing the step up key while Average/Hold Number is the active function, or sending the remote command CALC:AVER:TCON UP.

Save

Most of the functions under this key work the same way in many measurements, so they are documented in [Save@2600@i](#).

The Amplitude Correction function under Save is documented here.

Amplitude Correction

Pressing this key selects **Amplitude Corrections** as the data type to be exported. Pressing this key again brings up the Select Menu, which allows the user to select which **Amplitude Correction** to save.

Amplitude Corrections are fully discussed in the documentation of the Input/Output key, under the Corrections softkey.

Key Path:	Save
Remote Command:	:MMEMory:STORe:CORRection 1 2 3 4 5 6, <filename>
Example:	:MMEM:STOR:CORR 2 "myAmpcor.csv" saves Correction 2 to the file myAmpcor.csv on the current path. The default path is My Documents\amplitudeCorrections.
Notes:	If the save is initiated via SCPI, and the file already exists, the file will be overwritten. Using the C: drive is strongly discouraged, since it runs the risk of being overwritten during an instrument software upgrade. Both single and double quotes are supported for any filename parameter over SCPI.

Dependencies:	Corrections are not supported by all Measurements. If in a Mode in which some Measurements support it, this key will be grayed out in measurements that do not. The key will not show at all if no measurements in the Mode support it. This key will not appear unless you have the proper option installed in your instrument.
Readback:	Selected Correction
Backwards Compatibility SCPI:	:MMEMory:STORe:CORRection ANTenna CABLe OTHer USER, <filename> For backwards compatibility, ANTenna maps to 1, CABLe maps to 2, OTHer maps to 3 and USER maps to 4
Initial S/W Revision:	A.02.00
Help Map ID:	2612

Correction Data File

A Corrections Data File contains a copy of one of the test set correction tables. Corrections provide a way to adjust the trace display for predetermined gain curves (such as for cable loss).

Corrections files are text files in .csv (comma separated values) form, to make them importable into Excel or other spreadsheet programs. The format for Corrections files is as follows.

Line #	Type of field	Example	Notes
1	File type, must be "Amplitude Correction"	Amplitude Correction	May not be omitted
2	File Description (in quotes)	"Correction Factors for 11966E"	60 characters max; may be empty but may not be omitted. If exceeds 60 characters, error -233 Too much data reported
3	Comment (in quotes)	"Class B Radiated"	60 characters max; may be empty but may not be omitted. . If exceeds 60 characters, error -233 Too much data reported
4	Instrument Version, Model #	A.02.06,N9020A	May be empty but may not be omitted
5	Option List, File Format Version	K03 LFE EXM ,01	May be empty but may not be omitted
6	Freq Unit to be used for all frequency values in the file	Frequency Unit,MHz	assumed to be Hz if omitted

Common Measurement Functions 1

Line #	Type of field	Example	Notes
7	Antenna Unit	Antenna Unit,None	If omitted leaves the Antenna unit unchanged. The amplitude unit in the Antenna Unit field is a conversion factor that is used to adjust the Y Axis Units of the current mode, if the mode supports Antenna Units. For more details on antenna correction data, refer to the Input/Output,Corrections key description. Allowable values: dBuv/m, dBuA/m, dBG, dBpT, None
8	Freq Interpolation	Frequency Interpolation,Linear	if omitted leaves the Freq Interpolation unchanged. Allowable values: Linear, Logarithmic
9	Bias value in mA	Bias,0.00	If omitted leaves the Bias value unchanged (added as of A.08.50)
10	Bias State	Bias State,On	If omitted leaves the Bias State unchanged. Allowable values: On, Off (added as of A.08.50)
11	Overlap, two values, Freq1 and Freq2, separated by commas.	Overlap,33500,40000	Uses Freq Unit from line 6. Thus, in this example Freq1=33.5 GHz, Freq2=40.0 GHz (see note below). If omitted leaves the overlap unchanged (added as of A.08.50)
12	DATA marker	DATA	Corrections data begins in the next line

Lines 2 through 5 can be empty but must appear in the file. Lines 6 through 11 are optional, the lines can be left out of the file altogether.

The Overlap row and the two Bias rows apply only to external mixing. Both are read-only, they are never written by the test set. The only way to insert or modify these rows is to edit the file with a text editor or a spreadsheet editor. These rows are intended for use by mixer manufacturers, as they allow the manufacturer to insert data about how the mixer corrections were generated and how they should be applied. The Bias rows allow you to specify whether to turn Bias on or off when the Correction is turned on and to specify a Bias value (turning off the Correction does not change the Bias, but turning it back on again sets it to the value specified in the file). The Overlap row allows you to specify an overlap region in which two different corrections may be applied. It is expected that in the corrections data itself, there will be TWO corrections values exactly at Max Freq, otherwise Overlap is ignored. The way the overlap is processed is as follows: if at any given time the current test set Start Freq is greater than Freq 1 and lower than Freq 2, and the current Stop Freq is greater than Freq 2, extend the first correction point at or above Freq 2 down to Freq 1, rather than using the correction data between Freq1 and Freq2.

The Antenna Unit row can only be used in Correction register 1, because there can only be one setting for Antenna Unit at any given time. If a Correction whose Antenna Unit is set to anything but None is loaded into any Correction register but 1, an error is generated (Mass storage error; Can only load an Antenna Unit into Correction 1). When a correction file is saved from any Correction register but 1, Antenna Unit is always written as None.

Similarly, the Bias rows can only be used in Correction register 1, because there can only be one setting for Bias at any given time. If a Correction file with a Bias or Bias State row is loaded into any Correction register but 1, an error is generated: Mass storage error; Can only load Bias Settings into Correction 1

The data follows the DATA row, as comma separated X, Y pairs; one pair per line.

For example, suppose you have an Antenna to correct for on an N9020A version A.02.06 and the correction data is:

- 0 dB at 200 MHz
- 17 dB at 210 MHz
- 14.8 dB at 225 MHz

Then the file will look like:

- Amplitude Correction
- "Correction Factors for 11966E"
- "Class B Radiated"
- A.02.06,N9020A
- P13 EA3 UK6,01
- Frequency Unit,MHz
- Antenna Unit,dBuV/m
- Frequency Interpolation,Linear
- DATA
- 200.000000,0.00
- 210.000000,17.00
- 225.000000,14.80

The choices for the 1 of N fields in the metadata are as follows:

- Frequency Unit: Hz, kHz, MHz, GHz
- Antenna Unit: dBuV/m, dBuA/m, dBG, dBpT, None
- Frequency Interpolation: Logarithmic, Linear

Multiport Adapter Amplitude Correction

Pressing this key selects **Multiport Adapter Amplitude Corrections** as the data type to be exported. Pressing this key again brings up the Select Menu, which allows the user to select which **Multiport Adapter Amplitude Correction** to save.

Amplitude Corrections are fully discussed in the documentation of the Input/Output key, under the Corrections softkey.

Key Path:	Save, Data, Amplitude Correction
-----------	---

Common Measurement Functions 1

Remote Command:	:MMEMory:STORe:MPADapter:CORRection 1 2 3 4 5 6 7 8 9 10 11 12 13 14 15 16, <filename>
Example:	:MMEM:STOR:MPAD:CORR 2 "myAmpcor.csv" saves Multiport Adapter Correction 2 to the file myAmpcor.csv on the current path. The default path is My Documents\amplitudeCorrections.
Notes:	If the save is initiated via SCPI, and the file already exists, the file will be overwritten. Using the C: drive is strongly discouraged, since it runs the risk of being overwritten during an instrument software upgrade. Both single and double quotes are supported for any filename parameter over SCPI.
Dependencies:	Corrections are not supported by all Measurements. If in a Mode in which some Measurements support it, this key will be grayed out in measurements that do not. The key will not show at all if no measurements in the Mode support it. This key will not appear unless you have the proper option installed in your instrument.
Readback:	Selected Correction
Backwards Compatibility SCPI:	For backwards compatibility only, the following parameters syntax is supported: :MMEMory:STORe:MPADapter:CORRection ANTenna CABLe OTHer USER, <filename> ANTenna maps to 1, CABLe maps to 2, OTHer maps to 3 and USER maps to 4
Initial S/W Revision:	A.10.00
Help Map ID:	0

Correction Data File

A Corrections Data File contains a copy of one of the analyzer correction tables. Corrections provide a way to adjust the trace display for predetermined gain curves (such as for cable loss).

Corrections files are text files in .csv (comma separated values) form, to make them importable into Excel or other spreadsheet programs. The format for Corrections files is as follows.

Line #	Type of field	Example	Notes
1	File type, must be "Amplitude Correction"	Amplitude Correction	May not be omitted
2	File Description (in quotes)	"Correction Factors for 11966E"	45 characters max; may be empty but may not be omitted. If exceeds 45 characters, error -233 Too much data reported

Common Measurement Functions 1

3	Comment (in quotes)	“Class B Radiated”	45 characters max; may be empty but may not be omitted. . If exceeds 45 characters, error –233 Too much data reported
4	Instrument Version, Model #	A.02.06,N9020A	May be empty but may not be omitted
5	Option List, File Format Version	K03 LFE EXM ,01	May be empty but may not be omitted
6	Freq Unit to be used for all frequency values in the file	Frequency Unit,MHz	assumed to be Hz if omitted
7	Antenna Unit,	Antenna Unit,None	If omitted leaves the Antenna unit unchanged. The amplitude unit in the Antenna Unit field is a conversion factor that is used to adjust the Y Axis Units of the current mode, if the mode supports Antenna Units. For more details on antenna correction data, refer to the Input/Output,Corrections key description. Allowable values: dBuv/m, dBuA/m, dBG, dBpT, None
8	Freq Interpolation	Frequency Interpolation,Linear	if omitted leaves the Freq Interpolation unchanged. Allowable values: Linear, Logarithmic
9	Bias value in mA	Bias,0.00	If omitted leaves the Bias value unchanged (added as of A.08.50)
10	Bias State	Bias State,On	If omitted leaves the Bias State unchanged. Allowable values: On, Off (added as of A.08.50)
11	Overlap, two values, Freq1 and Freq2, separated by commas.	Overlap,33500,40000	Uses Freq Unit from line 6. Thus, in this example Freq1=33.5 GHz, Freq2= 40.0 GHz (see note below). If omitted leaves the overlap unchanged (added as of A.08.50)
12	DATA marker	DATA	Corrections data begins in the next line

Lines 2 through 5 can be empty but must appear in the file. Lines 6 through 11 are optional, the lines can be left out of the file altogether.

The Overlap row and the two Bias rows apply only to external mixing. Both are read-only, they are never written by the analyzer. The only way to insert or modify these rows is to edit the file with a text editor or a spreadsheet editor. These rows are intended for use by mixer manufacturers, as they allow the manufacturer to insert data about how the mixer corrections were generated and how they should be applied. The Bias rows allow you to specify whether to turn Bias on or off when the Correction is turned on and to specify a Bias value (turning off the Correction does not change the Bias, but turning it back on again sets it to the value specified in the file). The Overlap row allows you to specify an overlap region in which two different corrections may be applied. It is expected that in the corrections data itself, there

Common Measurement Functions 1

will be TWO corrections values exactly at Max Freq, otherwise Overlap is ignored. The way the overlap is processed is as follows: if at any given time the current analyzer Start Freq is greater than Freq 1 and lower than Freq 2, and the current Stop Freq is greater than Freq 2, extend the first correction point at or above Freq 2 down to Freq 1, rather than using the correction data between Freq1 and Freq2.

The Antenna Unit row can only be used in Correction register 1, because there can only be one setting for Antenna Unit at any given time. If a Correction whose Antenna Unit is set to anything but None is loaded into any Correction register but 1, an error is generated (Mass storage error; Can only load an Antenna Unit into Correction 1). When a correction file is saved from any Correction register but 1, Antenna Unit is always written as None.

Similarly, the Bias rows can only be used in Correction register 1, because there can only be one setting for Bias at any given time. If a Correction file with a Bias or Bias State row is loaded into any Correction register but 1, an error is generated: Mass storage error; Can only load Bias Settings into Correction 1

The data follows the DATA row, as comma separated X, Y pairs; one pair per line.

For example, suppose you have an Antenna to correct for on an N9020A version A.02.06 and the correction data is:

- 0 dB at 200 MHz
- 17 dB at 210 MHz
- 14.8 dB at 225 MHz

Then the file will look like:

- Amplitude Correction
- "Correction Factors for 11966E"
- "Class B Radiated"
- A.02.06,N9020A
- P13 EA3 UK6,01
- Frequency Unit,MHz
- Antenna Unit,dBuV/m
- Frequency Interpolation,Linear
- DATA
- 200.000000,0.00
- 210.000000,17.00
- 225.000000,14.80

The choices for the 1 of N fields in the metadata are as follows:

- Frequency Unit: Hz, kHz, MHz, GHz
- Antenna Unit: dBuv/m, dBuA/m, dBG, dBpT, None
- Frequency Interpolation: Logarithmic, Linear

Multiport Adapter Amplitude Correction 1,2,3,4,5,6,7,8,9,10,11,~,15,16

These keys let you pick which Correction to save. Once selected, the key returns back to the Export Data menu and the selected Correction number is annotated on the key.

The next step in the Save process is to select the Save As key in the Export Data menu.

Key Path:	Save, Data, Amplitude Correction, Multiport Adptr Correction
Preset:	Not part of a Preset, but is reset to Correction 1 by Restore Input/Output Defaults. Survives a shutdown.
Readback:	1
Initial S/W Revision:	A.10.00
Help Map ID:	0

Single (Single Measurement/Sweep)

Sets the test set for Single measurement operation. The single/continuous state is Meas Global, so the setting will affect all the measurements. If you are Paused, pressing Single does a Resume.

Key Path:	Front-panel key
Example:	:INIT:CONT OFF
Notes:	See Cont key description.
Backwards Compatibility Notes:	For Spectrum Analysis mode in ESA and PSA, the Single hardkey and the INITiate:IMM switched from continuous measurement to single measurement and restarted sweeps and averages (displayed average count reset to 1), but did not restart Max Hold and Min Hold . In the X-Series, the Single hardkey and the INITiate:IMM command initiate a sweep/ measurement/ average sequence/hold sequence including Max Hold and Min Hold . For Spectrum Analysis mode in ESA and PSA, the Single hardkey restarted the sweep regardless of whether or not you were in an active sweep or sweep sequence. In the X-Series, Restart does this but Single only restarts the sweep or sweep sequence if you are in the idle state.
Initial S/W Revision:	Prior to A.02.00
Help Map ID:	3515

Source (Internal)

Opens a menu of keys that access various source configuration menus and settings. In the test set, pressing this key also causes the central view area to change and display the Source Control Main view.

Key Path:	Front-panel key
Help Map ID:	35360

Common Measurement Functions 1

RF Output

This parameter sets the source RF power output state.

Key Path:	Source
Remote Command:	:OUTPut [:EXTErnal] [:STATe] ON OFF 1 0 :OUTPut [:EXTErnal] [:STATe] ?
Example:	OUTP OFF OUTP?
Notes:	<p>This setting is for the independent mode and has no effect on the “List Sequencer” on page 1586. If the “Sequencer” on page 1587 is set to ON, the list sequencer controls the source output and this key will be grayed-out. And this setting will be none-forceful grey out on front panel to indicate out-of-scope. Non-forceful means user still can change this setting by SCPI but cannot change on front panel. When set to OFF will make source leave list sequencer and this setting will be black out and take effect immediately.</p> <p>When the RF Output is ON, an “RF” annunciator is displayed in the system settings panel. When the RF Output is turned Off, the RF annunciator is cleared. If the “Sequencer” on page 1587 is set to ON, the “RF” annunciator will be replaced by “SEQ” in the system settings panel, indicating that the output is controlled by the list sequencer.</p>
Preset:	Off
Range:	On Off
Initial S/W Revision:	A.05.00
Help Map ID:	35361

Amplitude

Allows you to access the Amplitude sub-menu.

Key Path:	Source
Notes:	<p>The sub-menu under this button is for independent mode and has no effect on “List Sequencer” on page 1586. If the “Sequencer” on page 1587 is set to ON, the list sequencer controls the source output and this key will be grayed-out on front panel to indicate out-of-scope. When you set “Sequencer” on page 1587 to Off will make source leave list sequencer and this button will be black out.</p>
Initial S/W Revision:	A.05.00
Help Map ID:	35362

RF Power

Allows you to adjust the power level of the source using the numeric keypad, step keys, or RPG. Pressing any digit, 0 through 9, on the numeric keypad brings up the unit terminator.

Please refer to the “RF Power Range ” on page 1500 table below for the valid ranges.

Key Path:	Source, Amplitude
Remote Command:	:SOURce:POWer[:LEVel][:IMMediate][:AMPLitude] <ampl> :SOURce:POWer[:LEVel][:IMMediate][:AMPLitude]?
Example:	SOUR:POW -100 dBm
Notes:	<p>Amplitude corrections can be specified for use with the source. In the event of amplitude corrections being applied, the valid ranges for the RF power do not change dependant on the current amplitude correction setting. If the combination of RF power + amplitude correction is higher or lower than the source output range, the Source Unleveled bit is set and the “Source Unleveled” indicator will appear on status panel to indicate that the source cannot maintain the output power that has been requested.</p> <p>When signal generator is unable to maintain the requested output level, the “Source Unleveled” indicator will appear on status panel. When the source output setting is restored to the normal range, the “Source Unleveled” is removed from status panel.</p> <p>Internal source has list sequence mode, which comprises of several steps which contain separate output power, frequency and waveform etc. When the source list sequence playing is complete, the last step keeps playing, and user can use this command to change the list sequence last step’s output power.</p> <p>The multiport adapter RFIO TX ports and GPS ports cannot ensure power accuracy when power setting is lower than -130dBm, this power setting value is defined by the sum of RF Power setting and related amplitude correction value. But user settable value could be lower than this limit. When application detected there exists power setting lower than -130dBm on MPA RFIO TX ports, then popup warning message. When application detected there exists power setting lower than -130dBm on MPA GPS ports, then popup warning message. This is only warning message, and check is performed when RF is ON.</p>
Dependencies:	The RF power is dependent on the RF output port and frequency, such that the current frequency and selected output port determine the valid range of power values.
Preset:	-100 dBm
Min:	The range of values depends on the current frequency and selected RF output port. Please refer to the “RF Power Range ” on page 1500 table below for the valid ranges.
Max:	The range of values depends on the current frequency and selected RF output port. Please refer to the “RF Power Range ” on page 1500 table below for the valid ranges.
Initial S/W Revision:	A.05.00
Help Map ID:	35363

Common Measurement Functions 1

RF Power Range

RF Output Port	Frequency Range	Min Output Power	Max Output Power
High Power RF Out	$10 \text{ MHz} \leq f \leq 6 \text{ GHz}$	-130 dBm	20 dBm
RFIO 1 & RFIO 2	$10 \text{ MHz} \leq f \leq 6 \text{ GHz}$	-130 dBm	0 dBm

Set Reference Power

This key allows you to set the power reference. Pressing this key turns the power reference state to ON, sets the reference power value to the current RF output power, maintains this power at the RF output, and sets the displayed power to 0.00 dB. All subsequent RF power values entered under Source>Amplitude>RF Power are interpreted as being relative to this reference power.

When you use a power reference, the signal generator outputs an RF power that is set relative to the reference power by the value entered under Source>Amplitude>RF Power as follows:

Output power = reference power entered power

Where:

reference power equals the original RF Power entered under Source>Amplitude>RF Power and set as the reference power

entered power equals a new value entered under Source>Amplitude>Amptd Offset

In addition, the displayed power value is the same as a new value entered under Source>Amplitude>RF Power.

NOTE	If Power Ref is set to ON with a reference value set, entering a value under Source>Amplitude>RF Power and pressing Set Reference Power will add that value to the existing Power Ref value. If you wish to change the reference power value to a new value entered under Source>Amplitude>RF Power, first you must set Power Ref to OFF and then press Set Reference Power.
-------------	---

Key Path:	Source, Amplitude
Dependencies:	This key is unavailable, and is grayed out when the “List Sequencer” on page 1586 is turned ON.
Initial S/W Revision:	A.05.00
Help Map ID:	35364

Power Ref

This key allows you to toggle the state of the power reference.

When you use a power reference, the signal generator outputs an RF power that is set relative to the reference power by the value entered under Source>Amplitude>RF Power as follows:

Output power = reference power + entered power

Where:

reference power equals the original RF Power entered under Source>Amplitude>RF Power and set as the reference power

entered power equals a new value entered under Source>Amplitude>Amptd Offset

For more information on Reference Frequency refer to [“Set Reference Power ” on page 1500](#)

Key Path:	Source, Amplitude
Remote Command:	:SOURce:POWer:REFerence <ampl> :SOURce:POWer:REFerence? :SOURce:POWer:REFerence:STATe OFF ON 0 1 :SOURce:POWer:REFerence:STATe?
Example:	SOUR:POW:REF 0.00 dBm SOUR:POW:REF:STATe ON
Dependencies:	This setting is unavailable and is grayed out when the “List Sequencer” on page 1586 is turned ON.
Couplings:	This value is coupled to the “Set Reference Power ” on page 1500 key such that pressing the Set Reference Power key updates the reference power with the current output power.
Preset:	0.00 dBm OFF
Min:	-125.00 dBm
Max:	10.00 dBm
Initial S/W Revision:	A.05.00
Help Map ID:	35365

Amptd Offset

Allows you to specify the RF output power offset value.

When the amplitude offset is set to zero (0) and you set a new offset value (positive or negative), the displayed amplitude value will change as follows and the RF output power will not change:

Displayed value = output power + offset value

Where:

output power equals the original RF Power entered under Source>Amplitude>RF Power

offset value equals the value entered under Source>Amplitude>Amptd Offset

When the amplitude offset is set to a value other than zero (0) and you enter a new RF power value under Source>Amplitude>RF Power, the displayed power will be the same as the value entered and the RF

Common Measurement Functions 1

output power will be equal to the value entered minus the offset value as follows:

Output power = entered power – offset power

Displayed Power = output power + offset power

Displayed power = entered power

Where:

entered power equals the amplitude entered under Source>Amplitude>RF Power

offset power equals the value previously entered and set under Source>Amplitude>Amptd Offset

Key Path:	Source, Amplitude
Remote Command:	:SOURce:POWer[:LEVel][:IMMediate]:OFFSet <rel_ampl> :SOURce:POWer[:LEVel][:IMMediate]:OFFSet?
Example:	SOUR:POW:OFFS 0.00 dB
Dependencies:	This setting is unavailable, and is grayed out when the List Sequencer is turned ON.
Preset:	0.00 dB
Min:	-200.00 dB
Max:	200.00 dB
Initial S/W Revision:	A.05.00
Help Map ID:	35366

ALC

Allows you to enable or disable the automatic leveling control (ALC) circuit.

The purpose of the ALC circuit is to hold output power at a desired level by adjusting the source's power circuits to compensate for power drift. Power drift occurs over time and changes in temperature.

Turning the ALC off disables the ALC circuitry, enabling you to measure the output at a specific point in a test setup and adjust as required for the desired power level at that point. Turning the ALC off is useful when the modulation consists of very narrow pulses that are below the pulse width specification of the ALC, or when the modulation consists of slow amplitude variations that the automatic leveling would remove.

Key Path:	Source, Amplitude
Remote Command:	:SOURce:POWer:ALC[:STATe] ON OFF 1 0 :SOURce:POWer:ALC[:STATe]?
Example:	SOUR:POW:ALC OFF SOUR:POW:ALC?
Preset:	On

Range:	On Off
Initial S/W Revision:	A.05.00
Help Map ID:	35367

Modulation

Allows you to toggle the state of the modulation.

Key Path:	Source
Remote Command:	:OUTPut:MODulation[:STATe] ON OFF 1 0 :OUTPut:MODulation[:STATe] ?
Example:	:OUTP:MOD OFF
Notes:	This setting is for independent mode and has no effect on “List Sequencer” on page 1586 . If the “Sequencer” on page 1587 is set to ON, the list sequencer controls the source output and this key will be grayed-out. And this setting will be none-forceful grey out on front panel to indicate out-of-scope. Non-forceful means user still can change this setting by SCPI but cannot change manually on front panel. When set to Off will make source leave list sequencer and this setting will be black out and take effect immediately. When the Modulation is ON, the “MOD” annunciator is displayed in the system settings panel. When the Modulation is turned Off, the “MOD” annunciator is cleared. If the “Sequencer” on page 1587 is set to ON, the “MOD” annunciator will be replaced by “SEQ” in the system settings panel indicating that the output is controlled by list sequencer.
Preset:	Off
Range:	On Off
Initial S/W Revision:	A.05.00
Help Map ID:	35373

Frequency

Allows you to access the Frequency sub-menu.

Key Path:	Source
Notes:	The sub-menu under this button is for independent mode and has no effect on “List Sequencer” on page 1586 . If the “Sequencer” on page 1587 is set to ON, the list sequencer controls the source output and this key will be grayed-out. And this button will be grey out on front panel to indicate out-of-scope. When set to Off will make source leave list sequencer and this button will be black out.
Initial S/W Revision:	A.05.00
Help Map ID:	35374

Common Measurement Functions 1

Frequency

Allows you to set the RF Output Frequency. You can adjust the frequency of the source using the numeric keypad, step keys, or RPG. Pressing any digit, 0 through 9, on the numeric keypad brings up the unit terminator.

Key Path:	Source, Frequency
Remote Command:	:SOURce:FREQuency[:CW] <freq> :SOURce:FREQuency[:CW]?
Example:	SOUR:FREQ 1.00 GHz
Notes:	Internal source has list sequence mode, which comprises of several steps which contain separate output power, frequency and waveform etc. When the source list sequence playing is complete, the last step keeps playing, and user can use this command to change the list sequence last step's output frequency.
Couplings:	The frequency value is coupled to the current channel band and number, such that updates to the band and number will update the frequency value to the corresponding absolute frequency.
Preset:	1.00 GHz
Min:	10.00 MHz
Max:	Hardware Dependant: Option 503 = 3.6 GHz Option 504 = 3.8 GHz
Initial S/W Revision:	A.05.00
Help Map ID:	35375

Channel

The frequency of the source can be specified by a channel number of a given frequency band. This key allows you to specify the current channel number. For the appropriate range of channel numbers for a given frequency band, refer to the following tables: “[GSM/EDGE Channel Number Ranges](#)” on page 1506, “[W-CDMA Channel Number Ranges](#)” on page 1506, “[CDMA 2000 / 1xEVDO Channel Number Ranges](#)” on page 1509, “[LTE FDD Channel Number Ranges](#)” on page 1511, “[LTE TDD Channel Number Ranges](#)” on page 1512, and “[TDSCDMA Channel Number Ranges](#)” on page 1513.

Key Path:	Source, Frequency
Remote Command:	:SOURce:FREQuency:CHANnels:NUMBer <int> :SOURce:FREQuency:CHANnels:NUMBer?
Example:	SOUR:FREQ:CHAN:NUMB 1
Notes:	This key is grayed out when the “ Radio Standard ” on page 1514 is set to NONE.

Common Measurement Functions 1

Dependencies:	This key is grayed out when the “Radio Standard” on page 1514 is set to NONE.
Couplings:	The channel number is coupled to the frequency value when the “Radio Standard” on page 1514 is not set to NONE. When the frequency value is changed, the channel number will increase or decrease to match the new frequency. If the frequency is not at an exact match for a channel number, the nearest channel number is displayed along with a greater than or less than sign to indicate the frequency is above or below the channel number.
Preset:	1
Min:	Please refer to the tables below for the valid ranges.
Max:	Please refer to the tables below for the valid ranges.
Initial S/W Revision:	A.05.00
Help Map ID:	35376

Common Measurement Functions 1

GSM/EDGE Channel Number Ranges

Band	Link (Device)	Range	Frequency (MHz)
P-GSM	Uplink (MS)	$1 \leq n \leq 124$	$890.0 + 0.2*n$
	Downlink (BS)	$1 \leq n \leq 124$	$935.0 + 0.2*n$
E-GSM	Uplink (MS)	$0 \leq n \leq 124$	$890.0 + 0.2*n$
		$975 \leq n \leq 1023$	$890.0 + 0.2*(n-1024)$
	Downlink (BS)	$0 \leq n \leq 124$	$935.0 + 0.2*n$
		$975 \leq n \leq 1023$	$935.0 + 0.2*(n-1024)$
DCS 1800	Uplink (MS)	$512 \leq n \leq 885$	$1710.200 + 0.20*(n-512)$
	Downlink (BS)	$512 \leq n \leq 885$	$1805.200 + 0.20*(n-512)$
PCS 1900	Uplink (MS)	$512 \leq n \leq 810$	$1850.200 + 0.2*(n-512)$
	Downlink (BS)	$512 \leq n \leq 810$	$1930.200 + 0.2*(n-512)$
R-GSM	Uplink (MS)	$0 \leq n \leq 124$	$890.0 + 0.2*n$
		$955 \leq n \leq 1023$	$890.0 + 0.2*(n-1024)$
	Downlink (BS)	$0 \leq n \leq 124$	$935.0 + 0.2*n$
		$955 \leq n \leq 1023$	$935.0 + 0.2*(n-1024)$
GSM 450	Uplink (MS)	$256 \leq n \leq 293$	$450.6 + 0.2*(n-259)$
	Downlink (BS)	$256 \leq n \leq 293$	$460.6 + 0.2*(n-259)$
GSM 480	Uplink (MS)	$306 \leq n \leq 340$	$479.000 + 0.20*(n-306)$
	Downlink (BS)	$306 \leq n \leq 340$	$489.000 + 0.20*(n-306)$
GSM 850	Uplink (MS)	$128 \leq n \leq 251$	$824.200 + 0.20*(n-128)$
	Downlink (BS)	$128 \leq n \leq 251$	$869.200 + 0.20*(n-128)$
GSM 700	Uplink (MS)	$438 \leq n \leq 516$	$777.200 + 0.20*(n-438)$
	Downlink (BS)	$438 \leq n \leq 516$	$747.200 + 0.20*(n-438)$
T-GSM810	Uplink (MS)	$350 \leq n \leq 425$	$806.0 + 0.20*(n-350)$
	Downlink (BS)	$350 \leq n \leq 425$	$851.0 + 0.20*(n-350)$

W-CDMA Channel Number Ranges

Band	Link (Device)	Range	Frequency (MHz)
Band I	Downlink	$10562 \leq n \leq 10838$	$n \div 5$
	Uplink	$9612 \leq n \leq 9888$	$n \div 5$

Band	Link (Device)	Range	Frequency (MHz)
Band II	Downlink	$412 \leq n \leq 687$ $9662 \leq n \leq 9938$	$n+5 + 1850.1$ $n+5$
	Uplink	$12 \leq n \leq 287$ $350 \leq n \leq 425$	$n+5 + 1850.1$ $n+5$
Band III	Downlink	$1162 \leq n \leq 1513$	$n+5 + 1575$
	Uplink	$937 \leq n \leq 1288$	$n+5 + 1525$
Band IV	Downlink	$537 \leq n \leq 1738$ $1887 \leq n \leq 2087$	$n+5 + 1805$ $n+5 + 1735.1$
	Uplink	$1312 \leq n \leq 1513$ $1662 \leq n \leq 1862$	$n+5 + 1450$ $n+5 + 1380.1$
Band V	Downlink	$1007 \leq n \leq 1087$ $4357 \leq n \leq 4458$	$n+5 + 670.1$ $n+5$
	Uplink	$782 \leq n \leq 862$ $4132 \leq n \leq 4233$	$n+5 + 670.1$ $n+5$
Band VI	Downlink	$1037 \leq n \leq 1062$ $4387 \leq n \leq 4413$	$n+5 + 670.1$ $n+5$
	Uplink	$812 \leq n \leq 837$ $4162 \leq n \leq 4188$	$n+5 + 670.1$ $n+5$
Band VII	Downlink	$2237 \leq n \leq 2563$ $2587 \leq n \leq 2912$	$n+5 + 2175$ $n+5 + 2105.1$
	Uplink	$2012 \leq n \leq 2338$ $2362 \leq n \leq 2687$	$n+5 + 2100$ $n+5 + 2030.1$
Band VIII	Downlink	$2937 \leq n \leq 3088$	$n+5 + 340$
	Uplink	$2712 \leq n \leq 2863$	$n+5 + 340$
Band IX	Downlink	$9237 \leq n \leq 9387$	$n+5$
	Uplink	$8762 \leq n \leq 8912$	$n+5$
Band X	Downlink	$3112 \leq n \leq 3388$ $3412 \leq n \leq 3687$	$n+5 + 1490$ $n+5 + 1430.1$
	Uplink	$2887 \leq n \leq 3163$ $3187 \leq n \leq 3462$	$n+5 + 1135$ $n+5 + 1075.1$

Common Measurement Functions 1

Band	Link (Device)	Range	Frequency (MHz)
Band XI	Downlink	$3712 \leq n \leq 3812$	$n+5 + 736$
	Uplink	$3487 \leq n \leq 3587$	$n+5 + 733$
Band XII	Downlink	$3837 \leq n \leq 3903$	$n+5 - 37$
		$3927 \leq n \leq 3992$	$n+5 - 54.9$
	Uplink	$3612 \leq n \leq 3678$	$n+5 - 22$
		$3702 \leq n \leq 3767$	$n+5 - 39.9$
Band XIII	Downlink	$4017 \leq n \leq 4043$	$n+5 - 55$
		$4067 \leq n \leq 4092$	$n+5 - 64.9$
	Uplink	$3792 \leq n \leq 3818$	$n+5 + 21$
		$3702 \leq n \leq 3767$	$n+5 - 39.9$
Band XIV	Downlink	$4117 \leq n \leq 4143$	$n+5 - 63$
		$4167 \leq n \leq 4192$	$n+5 - 72.9$
	Uplink	$3892 \leq n \leq 3918$	$n+5 + 12$
		$3942 \leq n \leq 3967$	$n+5 + 2.1$

CDMA 2000 / 1xEVDO Channel Number Ranges

Band	Link (Device)	Range	Frequency (MHz)
US Cellular	Uplink (MS, reverse link)	$1 \leq N \leq 799$ $991 \leq N \leq 1023$ $1024 \leq N \leq 1323$	$0.030 \times N + 825.000$ $0.030 \times (N - 1023) + 825.000$ $0.030 \times (N - 1024) + 815.040$
	Downlink (BS, forward link)	$1 \leq N \leq 799$ $991 \leq N \leq 1023$ $1024 \leq N \leq 1323$	$0.030 \times N + 870.000$ $0.030 \times (N - 1023) + 870.000$ $0.030 \times (N - 1024) + 860.040$
US PCS	Uplink (MS, reverse link)	$0 \leq N \leq 1199$	$1850.000 + 0.050 \times N$
	Downlink (BS, forward link)	$0 \leq N \leq 1199$	$1930.000 + 0.050 \times N$
Japan Cellular Band	Uplink (MS, reverse link)	$1 \leq N \leq 799$ $801 \leq N \leq 1039$ $1041 \leq N \leq 1199$ $1201 \leq N \leq 1600$	$0.0125 \times (N + 915.000)$ $0.0125 \times (N - 800) + 898.000$ $0.0125 \times (N - 1040) + 887.000$ $0.0125 \times (N - 1200) + 893.000$
	Downlink (BS, forward link)	$1 \leq N \leq 799$ $801 \leq N \leq 1039$ $1041 \leq N \leq 1199$ $1201 \leq N \leq 1600$	$0.0125 \times (N + 860.000)$ $0.0125 \times (N - 800) + 843.000$ $0.0125 \times (N - 1040) + 832.000$ $0.0125 \times (N - 1200) + 838.000$
Korean PCS Band	Uplink (MS, reverse link)	$0 \leq N \leq 599$	$0.050 \times N + 1750.000$
	Downlink (BS, forward link)	$0 \leq N \leq 599$	$0.050 \times N + 1840.000$
NMT-450 Band	Uplink (MS, reverse link)	$1 \leq N \leq 400$ $472 \leq N \leq 871$ $1039 \leq N \leq 1473$ $1536 \leq N \leq 1715$ $1792 \leq N \leq 2016$	$0.025 \times (N - 1) + 450.000$ $0.025 \times (N - 472) + 410.000$ $0.020 \times (N - 1024) + 451.010$ $0.025 \times (N - 1536) + 479.000$ $0.020 \times (N - 1792) + 479.000$
	Downlink (BS, forward link)	$1 \leq N \leq 400$ $472 \leq N \leq 871$ $1039 \leq N \leq 1473$ $1536 \leq N \leq 1715$ $1792 \leq N \leq 2016$	$0.025 \times (N - 1) + 460.000$ $0.025 \times (N - 472) + 420.000$ $0.020 \times (N - 1024) + 461.010$ $0.025 \times (N - 1536) + 489.000$ $0.020 \times (N - 1792) + 489.000$

Common Measurement Functions 1

Band	Link (Device)	Range	Frequency (MHz)
IMT-2000 Band	Uplink (MS, reverse link)	$0 \leq N \leq 1199$	$1920.000 + 0.050 \times N$
	Downlink (BS, forward link)	$0 \leq N \leq 1199$	$2100.000 + 0.050 \times N$
Upper 700 MHz Band	Uplink (MS, reverse link)	$0 \leq N \leq 240$	$776.000 + 0.050 \times N$
	Downlink (BS, forward link)	$0 \leq N \leq 240$	$746.000 + 0.050 \times N$
Secondary 800 MHz Band	Uplink (MS, reverse link)	$0 \leq N \leq 719$ $720 \leq N \leq 919$	$0.025 \times N + 806.000$ $0.025 \times (N - 720) + 896.000$
	Downlink (BS, forward link)	$0 \leq N \leq 719$ $720 \leq N \leq 919$	$0.025 \times N + 851.000$ $0.025 \times (N - 720) + 935.000$
2.5 GHz IMT Extension	Uplink (MS, reverse link)	$0 \leq N \leq 1399$	$2500.000 + 0.050 \times N$
	Downlink (BS, forward link)	$0 \leq N \leq 1399$	$2620.000 + 0.050 \times N$
US PCS 1.9 GHz	Uplink (MS, reverse link)	$0 \leq N \leq 1299$	$1850.000 + 0.050 \times N$
	Downlink (BS, forward link)	$0 \leq N \leq 1299$	$1930.000 + 0.050 \times N$
AWS	Uplink (MS, reverse link)	$0 \leq N \leq 899$	$1710.000 + 0.050 \times N$
	Downlink (BS, forward link)	$0 \leq N \leq 899$	$2100.000 + 0.050 \times N$
US 2.5 GHz	Uplink (MS, reverse link)	$140 \leq N \leq 1459$	$2495.000 + 0.050 \times N$
	Downlink (BS, forward link)	$140 \leq N \leq 1459$	$2617.000 + 0.050 \times N$
700 Public Safety	Uplink (MS, reverse link)	$0 \leq N \leq 240$	$787.000 + 0.050 \times N$
	Downlink (BS, forward link)	$0 \leq N \leq 240$	$757.000 + 0.050 \times N$
C2K Lower 700	Uplink (MS, reverse link)	$0 \leq N \leq 360$	$698.000 + 0.050 \times N$
	Downlink (BS, forward link)	$0 \leq N \leq 360$	$728.000 + 0.050 \times N$

Band	Link (Device)	Range	Frequency (MHz)
400 Euro PAMR	Uplink (MS, reverse link)	$1 \leq N \leq 400$	$0.025 \times (N-1) + 450.000$
		$472 \leq N \leq 871$	$0.025 \times (N-472) + 410.000$
		$1536 \leq N \leq 1715$	$0.025 \times (N-1536) + 479.000$
	Downlink (BS, forward link)	$1 \leq N \leq 400$	$0.025 \times (N-1) + 460.000$
		$472 \leq N \leq 871$	$0.025 \times (N-472) + 420.000$
		$1536 \leq N \leq 1715$	$0.025 \times (N-1536) + 489.000$
800 PAMR	Uplink (MS, reverse link)	$0 \leq N \leq 239$	$870.0125 + 0.025 \times N$
	Downlink (BS, forward link)	$0 \leq N \leq 239$	$915.0125 + 0.025 \times N$

LTE FDD Channel Number Ranges

The carrier frequency in the uplink and downlink is designated by the E-UTRA Absolute Radio Frequency Channel Number (EARFCN) in the range 0 – 65535. The relation between EARFCN and the carrier frequency in MHz for the downlink is given by the following equation, where F_{DL_low} and $N_{Offs-DL}$ are given in table 5.4.4–1 and N_{DL} is the downlink EARFCN.

$$F_{DL} = F_{DL_low} + 0.1(N_{DL} - N_{Offs-DL})$$

The relation between EARFCN and the carrier frequency in MHz for the uplink is given by the following equation where F_{UL_low} and $N_{Offs-UL}$ are given in table 5.4.4–1 and N_{UL} is the uplink EARFCN.

$$F_{UL} = F_{UL_low} + 0.1(N_{UL} - N_{Offs-UL})$$

Band	Downlink			Uplink		
	F_{DL_low} (MHz)	$N_{Offs-DL}$	Range of N_{DL}	F_{UL_low} (MHz)	$N_{Offs-UL}$	Range of N_{UL}
1	2110	0	0 – 599	1920	18000	18000 – 18599
2	1930	600	600 - 1199	1850	18600	18600 – 19199
3	1805	1200	1200 – 1949	1710	19200	19200 – 19949
4	2110	1950	1950 – 2399	1710	19950	19950 – 20399
5	869	2400	2400 – 2649	824	20400	20400 – 20649
6	875	2650	2650 – 2749	830	20650	20650 – 20749

Common Measurement Functions 1

7	2620	2750	2750 – 3449	2500	20750	20750 – 20449
8	925	3450	3450 – 3799	880	21450	21450 – 21799
9	1844.9	3800	3800 – 4149	1749.9	21800	21800 – 22149
10	2110	4150	4150 – 4749	1710	22150	22150 – 22749
11	1475.9	4750	4750 – 4949	1427.9	22750	22750 – 22949
12	729	5010	5010 – 5179	699	23010	23010 – 23179
13	746	5180	5180 – 5279	777	23180	23180 – 23279
14	758	5280	5280 – 5379	788	23280	23280 – 23379
...						
17	734	5730	5730 – 5849	704	23730	23730 – 23849
18	860	5850	5850 – 5999	815	23850	23850 – 23999
19	875	6000	6000 – 6149	830	24000	24000 – 24149
20	791	6150	6150 – 6449	832	24150	24150 – 24449
21	1495.9	6450	6450 – 6599	1447.9	24450	24450 – 24599
...						
24	1525	7700	7700 – 8039	1626.5	25700	25700 – 26039
25	1930	8040	8040 – 8689	1850	26040	26040 – 26689
26	859	8690	8690 - 9039	814	26690	26690 - 27039
...						

Note: The channel numbers that designate carrier frequencies so close to the operating band edges that the carrier extends beyond the operating band edge shall not be used. This implies that the first 7, 15, 25, 50, 75 and 100 channel numbers at the lower operating band edge and the last 6, 14, 24, 49, 74 and 99 channel numbers at the upper operating band edge shall not be used for channel bandwidths of 1.4, 3, 5, 10, 15 and 20 MHz respectively.

LTE TDD Channel Number Ranges

The carrier frequency in the uplink and downlink is designated by the E-UTRA Absolute Radio Frequency Channel Number (EARFCN) in the range 0 – 65535. The relation between EARFCN and the carrier frequency in MHz for the downlink is given by the following equation, where F_{DL_low} and $N_{Offs-DL}$ are given in table 5.4.4–1 and N_{DL} is the downlink EARFCN.

$$F_{DL} = F_{DL_low} + 0.1(N_{DL} - N_{Offs-DL})$$

The relation between EARFCN and the carrier frequency in MHz for the uplink is given by the following equation where F_{UL_low} and $N_{Offs-UL}$ are given in table 5.4.4–1 and N_{UL} is the uplink EARFCN.

$$F_{UL} = F_{UL_low} + 0.1(N_{UL} - N_{Offs-UL})$$

Band	Downlink			Uplink		
	F _{DL_low} (MHz)	N _{Offs-DL}	Range of N _{DL}	F _{UL_low} (MHz)	N _{Offs-UL}	Range of N _{UL}
33	1900	36000	36000 – 36199	1900	36000	36000 – 36199
34	2010	36200	36200 – 36349	2010	36200	36200 – 36349
35	1850	36350	36350 – 36949	1850	36350	36350 – 36949
36	1930	36950	36950 – 37549	1930	36950	36950 – 37549
37	1910	37550	37550 – 37749	1910	37550	37550 – 37749
38	2570	37750	37750 – 38249	2570	37750	37750 – 38249
39	1880	38250	38250 – 38649	1880	38250	38250 – 38649
40	2300	38650	38650 – 39649	2300	38650	38650 – 39649
41	2496	39650	39650 – 41589	2496	39650	39650 – 41589
42	3400	41590	41590 – 43589	3400	41590	41590 – 43589
43	3600	43590	43590 – 45589	3600	43590	43590 – 45589

Note: The channel numbers that designate carrier frequencies so close to the operating band edges that the carrier extends beyond the operating band edge shall not be used. This implies that the first 7, 15, 25, 50, 75 and 100 channel numbers at the lower operating band edge and the last 6, 14, 24, 49, 74 and 99 channel numbers at the upper operating band edge shall not be used for channel bandwidths of 1.4, 3, 5, 10, 15 and 20 MHz respectively.

TDSCDMA Channel Number Ranges

1.28 Mcps TDD Option

No TX-RX frequency separation is required as Time Division Duplex (TDD) is employed. Each subframe consists of 7 main timeslots where all main timeslots (at least the first one) before the single switching point are allocated DL and all main timeslots (at least the last one) after the single switching point are allocated UL.

The nominal channel spacing is 1.6 MHz, but this can be adjusted to optimise performance in a particular deployment scenario.

The carrier frequency is designated by the UTRA absolute radio frequency channel number (UARFCN). The value of the UARFCN in the IMT2000 band is defined in the general case as follows:

$$N_t = 5 * F \quad 0.0 \text{ MHz} \leq F \leq 3276.6 \text{ MHz}$$

where F is the carrier frequency in MHz

Additional channels applicable to operation in the frequency band defined in sub-clause 5.2(d) are defined via the following UARFCN definition:

$$N_t = 5 * (F - 2150.1 \text{ MHz}) \quad 2572.5 \text{ MHz} \leq F \leq 2617.5 \text{ MHz}$$

Common Measurement Functions 1

UARFCN

1.28 Mcps TDD Option

The following UARFCN range shall be supported for each band:

Table: UTRA Absolute Radio Frequency Channel Number 1.28 Mcps TDD Option

Frequency Band	Frequency Range	UARFCN Uplink and Downlink transmission
For operation in frequency band as defined in subclause 5.2 (a)	1900–1920 MHz	9504 to 9596
	2010–2025 MHz	10054 to 10121
For operation in frequency band as defined in subclause 5.2 (b)	1850–1910 MHz	9254 to 9546
	1930–1990 MHz	9654 to 9946
For operation in frequency band as defined in subclause 5.2 (c)	1910–1930 MHz	9554 to 9646
For operation in frequency band as defined in subclause 5.2 (d)	2570–2620 MHz	12854 to 13096
For operation in frequency band as defined in subclause 5.2 (e)	2300–2400 MHz	11504 to 11996
For operation in frequency band as defined in subclause 5.2 (f)	1880–1920 MHz	9404 to 9596

Radio Setup

Allows access to the sub-menus for selecting the radio standard and associated radio band. You can also set a frequency reference and offset.

Key Path:	Source, Frequency
Initial S/W Revision:	A.05.00
Help Map ID:	35377

Radio Standard

Allows access to the channel band sub-menus to select the desired radio standard. When you have selected the radio standard, you can then set an active channel band. The radio standard and the active channel band allow you to use channel numbers to set frequency automatically.

Key Path:	Source, Frequency, Radio Setup
-----------	---------------------------------------

Remote Command:	:SOURce:FREQuency:CHANnels: BAND NONE PGSM EGSM RGSM DCS1800 PCS1900 TGSM810 GSM450 GSM480 GSM700 GSM850 BANDI BANDII BANDIII BANDIV BANDV BANDVI BANDVII BANDVIII BANDIX BANDX BANDXI BANDXII BANDXIII BANDXIV USCELL USPCS JAPAN KOREAN NMT IMT2K UPPER SECOND PAMR400 PAMR800 IMTEXT PCS1DOT9G AWS US2DOT5G PUBLIC LOWER BAND1 BAND2 BAND3 BAND4 BAND5 BAND6 BAND7 BAND8 BAND10 BAND11 BAND12 BAND13 BAND14 BAND17 BAND18 BAND19 BAND20 BAND21 BAND24 BAND25 BAND26 BAND33 BAND34 BAND35 BAND36 BAND37 BAND38 BAND39 BAND40 BAND41 BAND42 BAND43 BANDA BANDB BANDC BANDD BANDE BANDF :SOURce:FREQuency:CHANnels: BAND?
Example:	SOUR:FREQ:CHAN:BAND PGSM
Notes:	Set this setting to “NONE” will grey out “Channel” on page 1504 Channel
Initial S/W Revision:	A.05.00
Help Map ID:	35378

None

Selects no radio standard for use. When you have selected the radio standard to NONE, you cannot use channel numbers to set frequency automatically. You will need to set the frequency manually.

Key Path:	Source, Frequency, Radio Setup, Radio Standard
Initial S/W Revision:	A.05.00
Help Map ID:	35678

GSM/EDGE

Sets GSM/EDGE as the radio standard for use and accesses the GSM/EDGE specific channel band sub-menus.

Key Path:	Source, Frequency, Radio Setup, Radio Standard
Initial S/W Revision:	A.05.00
Help Map ID:	35379

P-GSM

Selects P-GSM as the active channel band.

Key Path:	Source, Frequency, Radio Setup, Radio Standard, GSM/EDGE
Example:	SOUR:FREQ:CHAN:BAND PGSM
Initial S/W Revision:	A.05.00
Help Map ID:	35380

Common Measurement Functions 1

E-GSM

Selects E-GSM as the active channel band.

Key Path:	Source, Frequency, Radio Setup, Radio Standard, GSM/EDGE
Example:	SOUR:FREQ:CHAN:BAND EGSM
Initial S/W Revision:	A.05.00
Help Map ID:	35381

R-GSM

Selects R-GSM as the active channel band.

Key Path:	Source, Frequency, Radio Setup, Radio Standard, GSM/EDGE
Example:	SOUR:FREQ:CHAN:BAND RGSM
Initial S/W Revision:	A.05.00
Help Map ID:	35382

DCS 1800

Selects DCS 1800 as the active channel band.

Key Path:	Source, Frequency, Radio Setup, Radio Standard, GSM/EDGE
Example:	SOUR:FREQ:CHAN:BAND DCS1800
Initial S/W Revision:	A.05.00
Help Map ID:	35383

PCS 1900

Selects PCS 1900 as the active channel band.

Key Path:	Source, Frequency, Radio Setup, Radio Standard, GSM/EDGE
Example:	SOUR:FREQ:CHAN:BAND PCS1900
Initial S/W Revision:	A.05.00
Help Map ID:	35384

GSM 450

Selects GSM 450 as the active channel band.

Key Path:	Source, Frequency, Radio Setup, Radio Standard, GSM/EDGE
Example:	SOUR:FREQ:CHAN:BAND GSM450
Initial S/W Revision:	A.05.00

Help Map ID:	35386
--------------	-------

GSM 480

Selects GSM 480 as the active channel band.

Key Path:	Source, Frequency, Radio Setup, Radio Standard, GSM/EDGE
Example:	SOUR:FREQ:CHAN:BAND GSM480
Initial S/W Revision:	A.05.00
Help Map ID:	35387

GSM 850

Selects GSM 850 as the active channel band.

Key Path:	Source, Frequency, Radio Setup, Radio Standard, GSM/EDGE
Example:	SOUR:FREQ:CHAN:BAND GSM850
Initial S/W Revision:	A.05.00
Help Map ID:	35389

GSM 700

Selects GSM 700 as the active channel band.

Key Path:	Source, Frequency, Radio Setup, Radio Standard, GSM/EDGE
Example:	SOUR:FREQ:CHAN:BAND GSM700
Initial S/W Revision:	A.05.00
Help Map ID:	35388

T-GSM 810

Selects T-GSM 810 as the active channel band.

Key Path:	Source, Frequency, Radio Setup, Radio Standard, GSM/EDGE
Example:	SOUR:FREQ:CHAN:BAND T-GSM810
Initial S/W Revision:	A.05.00
Help Map ID:	35385

WCDMA

Sets WCDMA as the radio standard for use and accesses the W-CDMA specific channel band sub-menus.

Key Path:	Source, Frequency, Radio Setup, Radio Standard
Initial S/W Revision:	A.05.00

Common Measurement Functions 1

Help Map ID:	35390
--------------	-------

Band I

Selects Band I as the active channel band.

Key Path:	Source, Frequency, Radio Setup, Radio Standard, WCDMA
Example:	SOUR:FREQ:CHAN:BAND BANDI
Initial S/W Revision:	A.05.00
Help Map ID:	35391

Band II

Selects Band II as the active channel band.

Key Path:	Source, Frequency, Radio Setup, Radio Standard, WCDMA
Example:	SOUR:FREQ:CHAN:BAND BANDII
Initial S/W Revision:	A.05.00
Help Map ID:	35392

Band III

Selects Band III as the active channel band.

Key Path:	Source, Frequency, Radio Setup, Radio Standard, WCDMA
Example:	SOUR:FREQ:CHAN:BAND BANDIII
Initial S/W Revision:	A.05.00
Help Map ID:	35393

Band IV

Selects Band IV as the active channel band.

Key Path:	Source, Frequency, Radio Setup, Radio Standard, WCDMA
Example:	SOUR:FREQ:CHAN:BAND BANDIV
Initial S/W Revision:	A.05.00
Help Map ID:	35394

Band V

Selects Band V as the active channel band.

Key Path:	Source, Frequency, Radio Setup, Radio Standard, WCDMA
Example:	SOUR:FREQ:CHAN:BAND BANDV

Initial S/W Revision:	A.05.00
Help Map ID:	35395

Band VI

Selects Band VI as the active channel band.

Key Path:	Source, Frequency, Radio Setup, Radio Standard, WCDMA
Example:	SOUR:FREQ:CHAN:BAND BANDVI
Initial S/W Revision:	A.05.00
Help Map ID:	35396

Band VII

Selects Band VII as the active channel band.

Key Path:	Source, Frequency, Radio Setup, Radio Standard, WCDMA
Example:	SOUR:FREQ:CHAN:BAND BANDVII
Initial S/W Revision:	A.05.00
Help Map ID:	35397

Band VIII

Selects Band VIII as the active channel band.

Key Path:	Source, Frequency, Radio Setup, Radio Standard, WCDMA
Example:	SOUR:FREQ:CHAN:BAND BANDVIII
Initial S/W Revision:	A.05.00
Help Map ID:	35398

Band IX

Selects Band IX as the active channel band.

Key Path:	Source, Frequency, Radio Setup, Radio Standard, WCDMA
Example:	SOUR:FREQ:CHAN:BAND BANDIX
Initial S/W Revision:	A.05.00
Help Map ID:	35399

Band X

Selects Band X as the active channel band.

Key Path:	Source, Frequency, Radio Setup, Radio Standard, WCDMA
-----------	--

Common Measurement Functions 1

Example:	SOUR:FREQ:CHAN:BAND BANDX
Initial S/W Revision:	A.05.00
Help Map ID:	35400

Band XI

Selects Band XI as the active channel band.

Key Path:	Source, Frequency, Radio Setup, Radio Standard, WCDMA
Example:	SOUR:FREQ:CHAN:BAND BANDXI
Initial S/W Revision:	A.05.00
Help Map ID:	35401

Band XII

Selects Band XII as the active channel band.

Key Path:	Source, Frequency, Radio Setup, Radio Standard, WCDMA
Example:	SOUR:FREQ:CHAN:BAND BANDXII
Initial S/W Revision:	A.05.00
Help Map ID:	35402

Band XIII

Selects band XIII as the active channel band.

Key Path:	Source, Frequency, Radio Setup, Radio Standard, WCDMA
Example:	SOUR:FREQ:CHAN:BAND BANDXIII
Initial S/W Revision:	A.05.00
Help Map ID:	35403

Band XIV

Selects Band XIV as the active channel band.

Key Path:	Source, Frequency, Radio Setup, Radio Standard, WCDMA
Example:	SOUR:FREQ:CHAN:BAND BANDXIV
Initial S/W Revision:	A.05.00
Help Map ID:	35404

CDMA 2000 / 1xEVDO

Sets CDMA 2000 / 1xEVDO as the radio standard for use and accesses the CDMA 2000/1xEVDO specific

channel band sub-menus.

Key Path:	Source, Frequency, Radio Setup, Radio Standard
Initial S/W Revision:	A.05.00
Help Map ID:	35405

US CELL

Selects US Cell as the active channel band.

Key Path:	Source, Frequency, Radio Setup, Radio Standard, CDMA 2000 / 1xEVDO
Example:	SOUR:FREQ:CHAN:BAND USCELL
Initial S/W Revision:	A.05.00
Help Map ID:	35406

US PCS

Selects US PCS as the active channel band.

Key Path:	Source, Frequency, Radio Setup, Radio Standard, CDMA 2000 / 1xEVDO
Example:	SOUR:FREQ:CHAN:BAND PCS
Initial S/W Revision:	A.05.00
Help Map ID:	35407

Japan Cell

Selects Japan Cell as the active channel band.

Key Path:	Source, Frequency, Radio Setup, Radio Standard, CDMA 2000 / 1xEVDO
Example:	SOUR:FREQ:CHAN:BAND JAPAN
Initial S/W Revision:	A.05.00
Help Map ID:	35408

Korean PCS

Selects Korean PCS as the active channel band.

Key Path:	Source, Frequency, Radio Setup, Radio Standard, CDMA 2000 / 1xEVDO
Example:	SOUR:FREQ:CHAN:BAND KOREAN
Initial S/W Revision:	A.05.00
Help Map ID:	35409

Common Measurement Functions 1

NMT 450

Selects NMT 450 as the active channel band.

Key Path:	Source, Frequency, Radio Setup, Radio Standard, CDMA 2000 / 1xEVDO
Example:	SOUR:FREQ:CHAN:BAND NMT
Initial S/W Revision:	A.05.00
Help Map ID:	35410

IMT 2000

Selects IMT 2000 as the active channel band.

Key Path:	Source, Frequency, Radio Setup, Radio Standard, CDMA 2000 / 1xEVDO
Example:	SOUR:FREQ:CHAN:BAND IMT2K
Initial S/W Revision:	A.05.00
Help Map ID:	35411

Upper 700

Selects Upper 700 as the active channel band.

Key Path:	Source, Frequency, Radio Setup, Radio Standard, CDMA 2000 / 1xEVDO
Example:	SOUR:FREQ:CHAN:BAND UPPER
Initial S/W Revision:	A.05.00
Help Map ID:	35412

Secondary 800

Selects Secondary 800 as the active channel band.

Key Path:	Source, Frequency, Radio Setup, Radio Standard, CDMA 2000 / 1xEVDO
Example:	SOUR:FREQ:CHAN:BAND SECOND
Initial S/W Revision:	A.05.00
Help Map ID:	35413

400 Euro PAMR

Selects 400 Euro PAMR as the active channel band.

Key Path:	Source, Frequency, Radio Setup, Radio Standard, CDMA 2000 / 1xEVDO
Example:	SOUR:FREQ:CHAN:BAND PAMR400
Initial S/W Revision:	A.05.00

Help Map ID:	35414
--------------	-------

800 PAMR

Selects 800 PAMR as the active channel band.

Key Path:	Source, Frequency, Radio Setup, Radio Standard, CDMA 2000 / 1xEVDO
Example:	SOUR:FREQ:CHAN:BAND PAMR800
Initial S/W Revision:	A.05.00
Help Map ID:	35415

2.5GHz IMT EXT

Selects 2.5 GHz IMT EXT as the active channel band.

Key Path:	Source, Frequency, Radio Setup, Radio Standard, CDMA 2000 / 1xEVDO
Example:	SOUR:FREQ:CHAN:BAND IMTEXT
Initial S/W Revision:	A.05.00
Help Map ID:	35416

US PCS 1.9GHz

Selects US PCS 1.9 GHz as the active channel band.

Key Path:	Source, Frequency, Radio Setup, Radio Standard, CDMA 2000 / 1xEVDO
Example:	SOUR:FREQ:CHAN:BAND PCS1DOT9G
Initial S/W Revision:	A.05.00
Help Map ID:	35417

AWS

Selects AWS as the active channel band.

Key Path:	Source, Frequency, Radio Setup, Radio Standard, CDMA 2000 / 1xEVDO
Example:	SOUR:FREQ:CHAN:BAND AWS
Initial S/W Revision:	A.05.00
Help Map ID:	35418

US 2.5GHz

Selects US 2.5 GHz as the active channel band.

Key Path:	Source, Frequency, Radio Setup, Radio Standard, CDMA 2000 / 1xEVDO
Example:	SOUR:FREQ:CHAN:BAND US2DOT5G

Common Measurement Functions 1

Initial S/W Revision:	A.05.00
Help Map ID:	35419

700 Public Safety

Selects 700 Public Safety as the active channel band.

Key Path:	Source, Frequency, Radio Setup, Radio Standard, CDMA 2000 / 1xEVDO
Example:	SOUR:FREQ:CHAN:BAND PUBLIC
Initial S/W Revision:	A.05.00
Help Map ID:	35420

C2K Lower 700

Selects C2K Lower 700 as the active channel band.

Key Path:	Source, Frequency, Radio Setup, Radio Standard, CDMA 2000 / 1xEVDO
Example:	SOUR:FREQ:CHAN:BAND LOWER
Initial S/W Revision:	A.05.00
Help Map ID:	35421

LTE

Sets LTE FDD as the radio standard for use and accesses the LTE FDD specific channel band sub-menus..

Key Path:	Source, Frequency, Radio Setup, Radio Standard
Initial S/W Revision:	A.09.50
Help Map ID:	35701

BAND 1

Selects BAND 1 as the band for the current step.

Key Path:	Source, Frequency, Radio Setup, Radio Standard, LTE
Example:	SOUR:FREQ:CHAN:BAND BAND1
Initial S/W Revision:	A.09.50
Help Map ID:	35702

BAND 2

Selects BAND 2 as the band for the current step.

Key Path:	Source, Frequency, Radio Setup, Radio Standard, LTE
Example:	SOUR:FREQ:CHAN:BAND BAND2

Initial S/W Revision:	A.09.50
Help Map ID:	35703

BAND 3

Selects BAND 3 as the band for the current step.

Key Path:	Source, Frequency, Radio Setup, Radio Standard, LTE
Example:	SOUR:FREQ:CHAN:BAND BAND3
Initial S/W Revision:	A.09.50
Help Map ID:	35704

BAND 4

Selects BAND 4 as the band for the current step.

Key Path:	Source, Frequency, Radio Setup, Radio Standard, LTE
Example:	SOUR:FREQ:CHAN:BAND BAND4
Initial S/W Revision:	A.09.50
Help Map ID:	35705

BAND 5

Selects BAND 5 as the band for the current step.

Key Path:	Source, Frequency, Radio Setup, Radio Standard, LTE
Example:	SOUR:FREQ:CHAN:BAND BAND5
Initial S/W Revision:	A.09.50
Help Map ID:	35706

BAND 6

Selects BAND 6 as the band for the current step.

Key Path:	Source, Frequency, Radio Setup, Radio Standard, LTE
Example:	SOUR:FREQ:CHAN:BAND BAND6
Initial S/W Revision:	A.09.50
Help Map ID:	35707

BAND 7

Selects BAND 7 as the band for the current step.

Key Path:	Source, Frequency, Radio Setup, Radio Standard, LTE
-----------	--

Common Measurement Functions 1

Example:	SOUR:FREQ:CHAN:BAND BAND7
Initial S/W Revision:	A.09.50
Help Map ID:	35708

BAND 8

Selects BAND 8 as the band for the current step.

Key Path:	Source, Frequency, Radio Setup, Radio Standard, LTE
Example:	SOUR:FREQ:CHAN:BAND BAND8
Initial S/W Revision:	A.09.50
Help Map ID:	35709

BAND 9

Selects BAND 9 as the band for the current step.

Key Path:	Source, Frequency, Radio Setup, Radio Standard, LTE
Example:	SOUR:FREQ:CHAN:BAND BAND9
Initial S/W Revision:	A.09.50
Help Map ID:	35710

BAND 10

Selects BAND 10 as the band for the current step.

Key Path:	Source, Frequency, Radio Setup, Radio Standard, LTE
Example:	SOUR:FREQ:CHAN:BAND BAND10
Initial S/W Revision:	A.09.50
Help Map ID:	35711

BAND 11

Selects BAND 11 as the band for the current step.

Key Path:	Source, Frequency, Radio Setup, Radio Standard, LTE
Example:	SOUR:FREQ:CHAN:BAND BAND11
Initial S/W Revision:	A.09.50
Help Map ID:	35712

BAND 12

Selects BAND 12 as the band for the current step.

Key Path:	Source, Frequency, Radio Setup, Radio Standard, LTE
Example:	SOUR:FREQ:CHAN:BAND BAND12
Initial S/W Revision:	A.09.50
Help Map ID:	35713

BAND 13

Selects BAND 13 as the band for the current step.

Key Path:	Source, Frequency, Radio Setup, Radio Standard, LTE
Example:	SOUR:FREQ:CHAN:BAND BAND13
Initial S/W Revision:	A.09.50
Help Map ID:	35714

BAND 14

Selects BAND 14 as the band for the current step.

Key Path:	Source, Frequency, Radio Setup, Radio Standard, LTE
Example:	SOUR:FREQ:CHAN:BAND BAND14
Initial S/W Revision:	A.09.50
Help Map ID:	35715

BAND 17

Selects BAND 17 as the band for the current step.

Key Path:	Source, Frequency, Radio Setup, Radio Standard, LTE
Example:	SOUR:FREQ:CHAN:BAND BAND17
Initial S/W Revision:	A.09.50
Help Map ID:	35716

BAND 18

Selects BAND 18 as the band for the current step.

Key Path:	Source, Frequency, Radio Setup, Radio Standard, LTE
Example:	SOUR:FREQ:CHAN:BAND BAND18
Initial S/W Revision:	A.09.50

Common Measurement Functions 1

Help Map ID:	35717
--------------	-------

BAND 19

Selects BAND 19 as the band for the current step.

Key Path:	Source, Frequency, Radio Setup, Radio Standard, LTE
Example:	SOUR:FREQ:CHAN:BAND BAND19
Initial S/W Revision:	A.09.50
Help Map ID:	35718

BAND 20

Selects BAND 20 as the band for the current step.

Key Path:	Source, Frequency, Radio Setup, Radio Standard, LTE
Example:	SOUR:FREQ:CHAN:BAND BAND20
Initial S/W Revision:	A.09.50
Help Map ID:	35719

BAND 21

Selects BAND 21 as the band for the current step.

Key Path:	Source, Frequency, Radio Setup, Radio Standard, LTE
Example:	SOUR:FREQ:CHAN:BAND BAND21
Initial S/W Revision:	A.09.50
Help Map ID:	35720

BAND 24

Selects BAND 24 as the band for the current step.

Key Path:	Source, Frequency, Radio Setup, Radio Standard, LTE
Example:	SOUR:FREQ:CHAN:BAND BAND24
Initial S/W Revision:	A.09.50
Help Map ID:	35721

BAND 25

Selects BAND 25 as the band for the current step.

Key Path:	Source, Frequency, Radio Setup, Radio Standard, LTE
Example:	SOUR:FREQ:CHAN:BAND BAND25

Initial S/W Revision:	A.09.50
Help Map ID:	35722

BAND 26

Selects BAND 26 as the band for the current step.

Key Path:	Source, Frequency, Radio Setup, Radio Standard, LTE
Example:	SOUR:FREQ:CHAN:BAND BAND26
Initial S/W Revision:	A.12.53
Help Map ID:	35804

LTE TDD

Sets LTE TDD as the radio standard for use and accesses the LTE TDD specific channel band sub-menus..

Key Path:	Source, Frequency, Radio Setup, Radio Standard
Initial S/W Revision:	A.11.50
Help Map ID:	35766

BAND 33

Selects BAND 33 as the band for the current step.

Key Path:	Source, Frequency, Radio Setup, Radio Standard, LTE TDD
Example:	SOUR:FREQ:CHAN:BAND BAND33
Initial S/W Revision:	A.11.50
Help Map ID:	35767

BAND 34

Selects BAND 34 as the band for the current step.

Key Path:	Source, Frequency, Radio Setup, Radio Standard, LTE TDD
Example:	SOUR:FREQ:CHAN:BAND BAND34
Initial S/W Revision:	A.11.50
Help Map ID:	35768

BAND 35

Selects BAND 35 as the band for the current step.

Key Path:	Source, Frequency, Radio Setup, Radio Standard, LTE TDD
Example:	SOUR:FREQ:CHAN:BAND BAND35

Common Measurement Functions 1

Initial S/W Revision:	A.11.50
Help Map ID:	35769

BAND 36

Selects BAND 36 as the band for the current step.

Key Path:	Source, Frequency, Radio Setup, Radio Standard, LTE TDD
Example:	SOUR:FREQ:CHAN:BAND BAND36
Initial S/W Revision:	A.11.50
Help Map ID:	35770

BAND 37

Selects BAND 37 as the band for the current step.

Key Path:	Source, Frequency, Radio Setup, Radio Standard, LTE TDD
Example:	SOUR:FREQ:CHAN:BAND BAND37
Initial S/W Revision:	A.11.50
Help Map ID:	35771

BAND 38

Selects BAND 38 as the band for the current step.

Key Path:	Source, Frequency, Radio Setup, Radio Standard, LTE TDD
Example:	SOUR:FREQ:CHAN:BAND BAND38
Initial S/W Revision:	A.11.50
Help Map ID:	35772

BAND 39

Selects BAND 39 as the band for the current step.

Key Path:	Source, Frequency, Radio Setup, Radio Standard, LTE TDD
Example:	SOUR:FREQ:CHAN:BAND BAND39
Initial S/W Revision:	A.11.50
Help Map ID:	35773

BAND 40

Selects BAND 40 as the band for the current step.

Key Path:	Source, Frequency, Radio Setup, Radio Standard, LTE TDD
-----------	--

Example:	SOUR:FREQ:CHAN:BAND BAND40
Initial S/W Revision:	A.11.50
Help Map ID:	35774

BAND 41

Selects BAND 41 as the band for the current step.

Key Path:	Source, Frequency, Radio Setup, Radio Standard, LTE TDD
Example:	SOUR:FREQ:CHAN:BAND BAND41
Initial S/W Revision:	A.11.50
Help Map ID:	35775

BAND 42

Selects BAND 42 as the band for the current step.

Key Path:	Source, Frequency, Radio Setup, Radio Standard, LTE TDD
Example:	SOUR:FREQ:CHAN:BAND BAND42
Initial S/W Revision:	A.11.50
Help Map ID:	35776

BAND 43

Selects BAND 43 as the band for the current step.

Key Path:	Source, Frequency, Radio Setup, Radio Standard, LTE TDD
Example:	SOUR:FREQ:CHAN:BAND BAND43
Initial S/W Revision:	A.11.50
Help Map ID:	35777

TDSCDMA

Sets TDSCDMA as the radio standard for use and accesses the TDSCDMA specific channel band sub-menus..

Key Path:	Source, Frequency, Radio Setup, Radio Standard
Initial S/W Revision:	A.11.50
Help Map ID:	35778

BAND A

Selects BAND A as the band for the current step.

Key Path:	Source, Frequency, Radio Setup, Radio Standard, TDSCDMA
-----------	--

Common Measurement Functions 1

Example:	SOUR:FREQ:CHAN:BAND BANDA
Initial S/W Revision:	A.11.50
Help Map ID:	35779

BAND B

Selects BAND B as the band for the current step.

Key Path:	Source, Frequency, Radio Setup, Radio Standard, TDSCDMA
Example:	SOUR:FREQ:CHAN:BAND BANDB
Initial S/W Revision:	A.11.50
Help Map ID:	35780

BAND C

Selects BAND C as the band for the current step.

Key Path:	Source, Frequency, Radio Setup, Radio Standard, TDSCDMA
Example:	SOUR:FREQ:CHAN:BAND BANDC
Initial S/W Revision:	A.11.50
Help Map ID:	35781

BAND D

Selects BAND D as the band for the current step.

Key Path:	Source, Frequency, Radio Setup, Radio Standard, TDSCDMA
Example:	SOUR:FREQ:CHAN:BAND BANDD
Initial S/W Revision:	A.11.50
Help Map ID:	35782

BAND E

Selects BAND E as the band for the current step.

Key Path:	Source, Frequency, Radio Setup, Radio Standard, TDSCDMA
Example:	SOUR:FREQ:CHAN:BAND BANDE
Initial S/W Revision:	A.11.50
Help Map ID:	35783

BAND F

Selects BAND F as the band for the current step.

Key Path:	Source, Frequency, Radio Setup, Radio Standard, TDSCDMA
Example:	SOUR:FREQ:CHAN:BAND BANDF
Initial S/W Revision:	A.11.50
Help Map ID:	35784

Radio Band Link

Allows you to specify the channel band type as either uplink or downlink link direction. This value is used in conjunction with the channel band and channel number to determine the absolute frequency output by the source. When set to “Uplink”, the source will calculate the uplink frequency using an uplink formula together with the selected channel band and channel number . When set to “Downlink”, the source will calculate the downlink frequency using a downlink formula together with the selected channel band and channel number.

Key Path:	Source, Frequency, Radio Setup
Remote Command:	:SOURce:RADio:BAND:LINK DOWN UP :SOURce:RADio:BAND:LINK?
Example:	SOUR:RAD:BAND:LINK UP
Preset:	DOWN
Range:	DOWN UP
Backwards Compatibility SCPI:	:SOURce:RADio:DEVIce BTS MS :SOURce:RADio:DEVIce?
Backwards Compatibility Notes:	BTS maps to the Downlink frequency MS maps to the Uplink frequency
Initial S/W Revision:	A.05.00
Help Map ID:	35422

Set Reference Frequency

This key allows you to set the frequency reference. Pressing this key turns the frequency reference state to ON, sets the reference frequency value to the current frequency, maintains this frequency at the RF output, and sets the displayed frequency to 0.00 Hz. All subsequent frequencies entered under Source>Frequency>Frequency are interpreted as being relative to this reference frequency.

When you use a frequency reference, the signal generator outputs a frequency that is set relative to the reference frequency by the value entered under Source>Frequency>Frequency as follows:

Output frequency = reference frequency - entered frequency

Where:

reference frequency equals the original RF frequency entered under Source>Frequency>Frequency and set as the reference frequency

Common Measurement Functions 1

entered frequency equals a new value entered under Source>Frequency>Frequency

In addition, the displayed frequency value will be the same as the value entered under Source>Frequency>Frequency.

NOTE If Freq Reference is set to ON with a reference value set, entering a value under Source>Frequency>Frequency and pressing Set Frequency Reference will add that value to the existing Freq Reference value.
If you wish to change the reference frequency value to the new value entered under Source>Frequency>Frequency, first you must set Freq Reference to OFF and then press Set Frequency Reference.

Key Path:	Source, Frequency
Remote Command:	:SOURce:FREQuency:REFeRence:SET
Example:	SOUR:FREQ:REF:SET
Dependencies:	This setting is unavailable, and is grayed out when the List Sequencer is turned ON.
Initial S/W Revision:	A.05.00
Help Map ID:	35423

Freq Reference

This key allows you to toggle the state of the frequency reference. When the frequency reference state is ON, an annunciator is displayed on the main source view to indicate this state to the user.

When you use a frequency reference, the signal generator outputs a frequency that is set relative to the reference frequency by the value entered under Source>Frequency>Frequency as follows:

Output frequency = reference frequency + entered frequency

Where:

reference frequency equals the original RF frequency entered under Source>Frequency>Frequency and set as the reference frequency

entered frequency equals a new value entered under Source>Frequency>Frequency

For more information on Reference Frequency refer to [“Set Reference Frequency” on page 1533](#)

Key Path:	Source, Frequency
Remote Command:	:SOURce:FREQuency:REFeRence <freq> :SOURce:FREQuency:REFeRence? :SOURce:FREQuency:REFeRence:STATe OFF ON 0 1 :SOURce:FREQuency:REFeRence:STATe?

Example:	SOUR:FREQ:REF 0.00 Hz SOUR:FREQ:REF:STATe ON
Dependencies:	This setting is unavailable, and is grayed out when the List Sequencer is turned ON.
Couplings:	The frequency reference state is coupled to the frequency reference set immediate action. When the reference set immediate action key is pressed, or the SCPI command issued, it turns the frequency reference state ON.
Preset:	0.00 Hz OFF
Min:	0.00 Hz
Max:	Hardware Dependant: Option 503 = 3.6 GHz Option 504 = 3.8 GHz
Initial S/W Revision:	A.05.00
Help Map ID:	35424

Freq Offset

Allows you to specify the frequency offset value. When the frequency offset state is ON, an annunciator is displayed on the main source view to indicate this state to the user.

When the frequency offset is set to zero (0) and you set a new offset value, the displayed frequency value will change as follows and the RF output frequency will not change:

$$\text{Displayed value} = \text{output frequency} + \text{offset value}$$

Where:

output frequency equals the original frequency entered under Source>Frequency>Frequency

offset value equals the value entered under Source>Frequency>Freq Offset

When the frequency offset is set to a value other than zero (0) and you enter a new frequency value under Source>Frequency>Frequency, the displayed frequency will be the same as the value entered and the RF output frequency will be equal to the value entered minus the offset value as follows:

$$\text{Output frequency} = \text{entered frequency} - \text{offset frequency}$$

$$\text{Displayed frequency} = \text{output frequency} + \text{offset frequency}$$

$$\text{Displayed frequency} = \text{entered frequency}$$

Where:

entered frequency equals the frequency entered under Source>Frequency>Frequency

offset frequency equals the value previously entered and set under Source>Frequency>Freq Offset

Key Path:	Source, Frequency
-----------	--------------------------

Common Measurement Functions 1

Remote Command:	:SOURce:FREQuency:OFFSet <freq> :SOURce:FREQuency:OFFSet?
Example:	SOUR:FREQ:OFFS 0 Hz
Dependencies:	This setting is unavailable, and is grayed out when the List Sequencer is turned ON.
Preset:	0 Hz
Min:	-100.00 GHz
Max:	100.00 GHz
Initial S/W Revision:	A.05.00
Help Map ID:	35425

Modulation Setup

Allows access to the menus for setting up the available modulation types: “ARB” on page 1536, “AM” on page 1582, “FM” on page 1583, and “PM” on page 1584.

Key Path:	Source
Initial S/W Revision:	A.05.00
Help Map ID:	35428

ARB

Allows you access to the ARB sub-menus.

Key Path:	Source, Modulation Setup
Initial S/W Revision:	A.05.00
Help Map ID:	35429

ARB

Allows you to toggle the state of the ARB function. When the ARB is On, a “MOD” annunciator is displayed in the system settings panel. When the ARB is turned Off, the MOD annunciator is cleared

Key Path:	Source, Modulation Setup, ARB
Remote Command:	:SOURce:RADio:ARB[:STATe] ON OFF 1 0 :SOURce:RADio:ARB[:STATe]?
Example:	SOUR:RAD:ARB OFF SOUR:RAD:ARB?

Notes:	If the ARB is ON, a user then loads or deletes another file to ARB memory, the playing waveform segment may not keep phase continuity during the ARB memory operation. The waveform will be replayed after the ARB operation is finished.
Dependencies:	<p>This setting is for independent mode and has no effect on 3.3.8 list sequencer mode. Setting 7.1Sequencer to On will put source enter list sequencer mode, and even if ARB state is On, the ARB file will not be played. Setting 7.1Sequencer to Off will make source leave list sequencer mode, and this setting will take effect immediately.</p> <p>The ARB can only be turned on when there is a waveform file selected for playback. On the GUI If no waveform is selected, this key is grayed out. If you send the SCPI command to turn the ARB on with no waveform selected for playback, the ARB state remains OFF and an error is generated. “-</p> <p>When you try to recall a certain set of states in which the selected waveform is not in ARB memory and the ARB state is On, errors are reported</p>
Preset:	Off
Range:	On Off
Initial S/W Revision:	A.05.00
Help Map ID:	35430

Select Waveform

Allows you to access to the waveform selection sub-menus.

Pressing this key changes the central view area to show the Waveform File Selection view.

Key Path:	Source, Modulation Setup, ARB
Initial S/W Revision:	A.05.00
Help Map ID:	35431

Select Waveform

Allows you to select a waveform sequence or segment for the dual ARB to play.

Key Path:	Source, Modulation Setup, ARB, Select Waveform
Remote Command:	:SOURce:RADio:ARB:WAVEform <string> :SOURce:RADio:ARB:WAVEform?
Example:	SOUR:RAD:ARB:WAV “test_waveform.bin”

Common Measurement Functions 1

Notes:	<p><string> - specifies the name of the waveform segment or waveform sequence to be played by the ARB.</p> <p>When in Sequence Analyzer mode, and Include Source is Yes, if the you attempt to play a waveform sequence but not all the required waveform segments are in the ARB playback memory, the application will reject the loading operation with an error is generated .</p> <p>When Include Source is No, if you attempt to play a waveform sequence but not all the required waveform segments are contained in the ARB playback memory, the application will attempt to load the required segments from either the default directory of the current directory. If the ARB memory does not have enough space for all the waveform segments to be loaded, an error is generated and none of the waveform segments is loaded.</p> <p>If the ARB is ON, and you attempt to play a waveform sequence but not all the waveform segments within the sequence could be found to be loaded into ARB memory, an error is generated. The selected waveform keeps the previous value and ARB state remains On.</p> <p>If you specify a waveform segment over SCPI but the waveform segment is not present within ARB playback memory and cannot be found for auto loading within the current directory or the default directory, an error is generated and the file selection remains unchanged.</p> <p>If you select a waveform for playback and the waveform requires a license that is not installed on the instrument, an error is generated. error is generated.</p> <p>If the ARB is ON and you load a file to ARB memory or delete a file from ARB memory, the playing waveform segment may not keep phase continuity during the ARB memory operation. The waveform will be replayed after the ARB operation is finished.</p>
Initial S/W Revision:	A.05.00
Help Map ID:	35432

Segments on Hard Disk

Allows you access to the sub-menus for loading waveform segments from the hard disk into ARB memory. The default directory is: D:\nvarb.

Pressing this key changes the current view to the Waveform Management View.

Key Path:	Source, Modulation Setup, ARB, Select Waveform
Initial S/W Revision:	A.05.00
Help Map ID:	35433

Load Segment To ARB Memory

Allows you to load the selected file into ARB memory. On the front panel you select the file for loading to the ARB memory by highlighting the desired file in the list. Using the SCPI command, you specify the file name on the HDD.

“NVWFM” (none-volatile storage) MSUS (Mass Storage Unit Specifier) is supported in the memory subsystem because the ARB memory cannot be accessed directly. Therefore, files must be downloaded to the instrument hard

disk and then loaded into the ARB memory. “NVWFM” MSUS will be mapped to the default directory D:\NVARB. The SCPI command supports using either “NVWFM” MSUS or specifying a full path. For more information, see “Memory Subsystem (Remote Command Only)” on page 1632.

If a file of the same name already exists within ARB memory, it is overwritten. If you wish to load two segments of the same name, you must rename one of the segments before loading it into ARB memory. To rename a segment, you can either use Windows File Explorer, or the :MMEMoRY:CoPY command.

Key Path:	Source, Modulation Setup, ARB, Select Waveform, Segments on Hard Disk
Remote Command:	:SoURce:RADio:ARB:LoAD <string>
Example:	SoUR:RAD:ARB:LoAD “D:\NVARB\testwaveform.bin” or SoUR:RAD:ARB:LoAD “NVWFM:testwaveform.bin”
Notes:	<p><string> - specifies the path name of the file to load from the HDD into ARB memory. It could be a <full path + filename>, or <“NVWFM” MSUS + colon + filename>.</p> <p>When in Sequence Analyzer mode, and Include Source is Yes, an attempt to load a file to ARB memory will be rejected with an error.</p> <p>When Include Source is No and if there is insufficient free ARB memory to load the selected waveform, an error is generated. .</p> <p>If you specify a file over SCPI, but the file is not at the specified location, an error is generated.</p> <p>If you try to load a waveform file but the file contains less than 500 IQ samples, an error is generated.</p> <p>If you try to load a Signal Studio waveform “*.wfm” which contains invalid waveform header, an error is generated.</p> <p>If the ARB is ON when you load a file to ARB memory or delete a file from ARB memory, the playing waveform segment may not keep phase continuity during the ARB memory operation. The waveform will be replayed after the ARB operation is finished.</p> <p>ARB can be loaded into ARB memory even required licenses do not present on the instrument. In this case, a GUI only warning message –800, “Operation complete; Loaded <filename> successfully, but no license <required licenses> installed”. User can install required licenses according to <required licenses> string to license it, or multi-pack license it.</p>
Initial S/W Revision:	A.05.00
Help Map ID:	35434

Load All To ARB Memory

Allows you to load all the segment files within the currently selected directory into ARB memory. If a file of the same name already exists within ARB memory, it is overwritten. If you wish to load two segments of the same name, you must rename one of the segments before loading it into ARB memory. To rename a segment, you can

Common Measurement Functions 1

either use Windows File Explorer, or the :MEMory:COpy command.

Key Path:	Source, Modulation Setup, ARB, Select Waveform, Segments on Hard Disk
Remote Command:	:SOURce:RADio:ARB:LOAD:ALL <string>
Example:	SOUR:RAD:ARB:LOAD:ALL "D:\nvarb"
Notes:	<p><string> - specifies the directory on the HDD to load the files into ARB memory from.</p> <p>When in Sequence Analyzer mode, and Include Source is Yes, an attempt to load all files from a directory to ARB memory is rejected with an error.</p> <p>When Include Source is No and there is insufficient free ARB memory to load all the waveforms, when the ARB memory is full, the copy ceases, and an error is generated.</p> <p>If you specify a directory over SCPI, but the directory does not exist, an error is generated.</p> <p>If the ARB is ON, a user then loads or deletes file to ARB memory, the playing waveform segment may not keep phase continuity during the ARB memory operation. The waveform will be replayed after the ARB operation is finished.</p>
Initial S/W Revision:	A.05.00
Help Map ID:	35435

Change Directory...

Allows you to change the currently selected directory on the hard disk. Pressing this key opens a standard windows change directory dialog allowing you to select the new directory of interest.

The current directory is used for manually loading waveform segments into ARB memory for playback, and as a search location for waveform segments that are required to be loaded into ARB memory for playback of a waveform sequence or a list sequence.

Key Path:	Source, Modulation Setup, ARB, Select Waveform, Segments on Hard Disk
Notes:	No remote command, SCPIfront panel only.
Initial S/W Revision:	A.05.00
Help Map ID:	35436

Default Directory...

Allows you to change the default directory. It is used as a search location for waveform segments that are required to be loaded into ARB memory for playback of a waveform sequence, and as a search location for selecting waveforms using SCPI.

Key Path:	Source, Modulation Setup, ARB, Select Waveform, Segments on Hard Disk
-----------	--

Remote Command:	:SOURce:RADio:ARB:DEFault:DIRectory <string> :SOURce:RADio:ARB: DEFault:DIRectory?
Example:	SOUR:RAD:ARB:DEF:DIR "D:\ArbFiles" SOUR:RAD:ARB:DEF:DIR?
State Saved:	Persistent, survives a power cycle and a preset but not saved in the instrument state
Initial S/W Revision:	A.05.00
Help Map ID:	35437

Segments in ARB Memory

Allows you access to the sub-menus for managing the files within ARB memory.

Key Path:	Source, Modulation Setup, ARB, Select Waveform
Initial S/W Revision:	A.05.00
Help Map ID:	35438

Delete Segment From ARB Mem

Allows you to remove a segment from ARB playback memory.

Key Path:	Source, Modulation Setup, ARB, Select Waveform, Segments in ARB Memory
Remote Command:	:SOURce:RADio:ARB:DELete <string>
Example:	SOUR:RAD:ARB:DEL "testwaveform.bin"

Common Measurement Functions 1

Notes:	<p><string> - specifies the waveform to be deleted from the ARB playback memory.</p> <p>When in Sequence Analyzer mode and Include Source is Yes, an attempt to delete a file from ARB memory is rejected with an error.</p> <p>When Include Source is No and you specify a file that does not exist within ARB memory, an error is generated.</p> <p>It is possible to delete files from within the ARB memory when the ARB is ON. However, if you attempt to delete the file that is currently playing an error is generated.</p> <p>It is possible to delete a file from within the ARB memory when the sequencer state is ON and the file is not being used by the List Sequencer. If you attempt to delete a file which is being used by the list sequencer, an error is generated.</p> <p>When sequencer state is On, even if ARB state is On, the selected waveform will not be played. In this case, if the selected waveform is not used in List Sequence, it can be deleted and the ARB state is turned Off.</p> <p>If the ARB is ON and you load a file to ARB memory or delete a file from ARB memory, the playing waveform segment may not keep phase continuity during the ARB memory operation. The waveform will be replayed after the ARB operation is finished.</p>
Initial S/W Revision:	A.05.00
Help Map ID:	35439

Delete All From ARB Memory

Allows you to remove all segments from ARB playback memory.

Key Path:	Source, Modulation Setup, ARB, Select Waveform, Segments in ARB Memory
Remote Command:	:SOURce:RADio:ARB:DELeTe:ALL
Example:	SOUR:RAD:ARB:DELeTe:ALL
Notes:	<p>When in Sequence Analyzer mode and Include Source is Yes, an attempt to delete all files from ARB memory is rejected with an error.</p> <p>When Include Source is No and you attempt to delete all files from ARB memory when the ARB is currently playing a file, all files except the one playing are deleted and an error is generated.</p> <p>If you attempt to delete all files from ARB memory when there are waveform files used in “List Sequencer” on page 1586 and “Sequencer” on page 1587 state is ON, all files except the files currently being used in list sequencer are deleted, and an error is generated.</p> <p>If the ARB is ON and you load a file to ARB memory or delete a file from ARB memory, the playing waveform segment may not keep phase continuity during the ARB memory operation. The waveform will be replayed after the ARB operation is finished.</p>
Initial S/W Revision:	A.05.00

Help Map ID:	35440
--------------	-------

Query ARB Memory File List (Remote Command Only)

Queries the test set for the list of waveform segments in the ARB memory.

NOTE This command returns a string for waveform segment names in ARB memory. If you want a string list of waveform segments in the ARB memory, use [“Query ARB Memory Full File List \(Remote Command Only\)”](#) on page 1543.

Remote Command:	:SOURce:RADio:ARB:CATalog?
Example:	SOUR:RAD:ARB:CATalog?
Notes:	The return data is in the following format: <integer> - memory used <integer> - memory free <string> ... - comma separated list of waveform segments within ARB memory
Initial S/W Revision:	A.05.00
Help Map ID:	35686

Query ARB Memory Full File List (Remote Command Only)

Queries the test set for the string list of waveform segments in the ARB memory. It returns a string list for waveform segment names in the ARB memory.

Remote Command:	:SOURce:RADio:ARB:FCATalog?
Example:	SOUR:RAD:ARB:FCATalog?
Notes:	The return data is in the following format: <integer> - memory used <integer> - memory free <integer> - file count in ARB memory <string>,<string>, ... <string> - comma separated string list of waveform segments within ARB memory Example: SOUR:RAD:ARB:FCAT? EXT returns: 27499,2069653,3,"c2k.wfm","gsm.wfm","wcdma.wfm"
Initial S/W Revision:	A.09.00
Help Map ID:	0

Common Measurement Functions 1

ARB Setup

Allows access to the ARB setup sub-menus.

Key Path:	Source, Modulation Setup, ARB
Initial S/W Revision:	A.05.00
Help Map ID:	35441

Sample Rate

Allows you to set the ARB waveform playback sample rate.

Key Path:	Source, Modulation Setup, ARB, ARB Setup
Remote Command:	:SOURce:RADio:ARB:SCLock:RATE <freq> :SOURce:RADio:ARB:SCLock:RATE?
Example:	SOUR:RAD:ARB:SCL:RATE 48.00 MHz
Dependencies:	When a new waveform is selected for playback the settings contained within the associated waveform header file are applied to the ARB. The sample rate is one of the values stored within the header file. If the newly selected waveform file has an associated header file, the sample rate is updated with the value from the header file. The sample rate will remain unchanged if the newly selected waveform does not have an associated header file.
Preset:	125.00 MHz
Min:	1.00 kHz
Max:	125.00 MHz
Initial S/W Revision:	A.05.00
Help Map ID:	35442

Run-Time Scaling

Allows you to adjust the run-time scaling value. The run-time scaling value is applied in real-time while the waveform is playing.

Key Path:	Source, Modulation Setup, ARB, ARB Setup
Remote Command:	:SOURce:RADio:ARB:RSCaling <real> :SOURce:RADio:ARB:RSCaling?
Example:	SOUR:RAD:ARB:RSC 100.00

Dependencies:	When a new waveform is selected for playback the settings contained within the associated waveform header file are applied to the ARB. The run-time scaling is one of the values stored within the header file. If the newly selected waveform file has an associated header file, the run-time scaling is updated with the value from the header file. The run-time scaling will remain unchanged if the newly selected waveform does not have an associated header file.
Preset:	70.00 %
Min:	1.00 %
Max:	100.00 %
Initial S/W Revision:	A.05.00
Help Map ID:	35443

Baseband Freq Offset

Allows you to adjust the value by which the baseband frequency is offset relative to the carrier.

Key Path:	Source, Modulation Setup, ARB, ARB Setup
Remote Command:	:SOURce:RADio:ARB:BASEband:FREQuency:OFFSet <freq> :SOURce:RADio:ARB:BASEband:FREQuency:OFFSet?
Example:	SOUR:RAD:ARB:BAS:FREQ:OFFS 0.00 Hz
Dependencies:	When a new waveform is selected for playback the settings contained within the associated waveform header file are applied to the ARB. The baseband frequency offset is one of the values stored within the header file. If the newly selected waveform file has an associated header file, the baseband frequency offset is updated with the value from the header file. The baseband frequency offset will remain unchanged if the newly selected waveform does not have an associated header file.
Preset:	0.00 Hz
Min:	-50.00 MHz
Max:	50.00 MHz
Initial S/W Revision:	A.05.00
Help Map ID:	35444

Trigger Type

Allows access to the trigger type sub-menus. The setting for trigger type determines the behavior of the waveform when it plays.

Key Path:	Source, Modulation Setup, ARB
-----------	--------------------------------------

Common Measurement Functions 1

Remote Command:	:SOURce:RADio:ARB:TRIGger:TYPE CONTInuous SINGLE SADVance GATE :SOURce:RADio:ARB:TRIGger:TYPE?
Example:	SOUR:RAD:ARB:TRIG:TYPE CONT SOUR:RAD:ARB:TRIG:TYPE?
Notes:	Gated trigger type will be implemented at a later release
Preset:	CONTInuous
Range:	Continuous Single Seg Adv Gated
Initial S/W Revision:	A.05.00
Help Map ID:	35454

Continuous

Sets the active trigger type to Continuous. If Continuous is already selected as the active trigger type, pressing this key allows access to the continuous trigger type setup menu. In Continuous trigger mode, the waveform repeats continuously.

Key Path:	Source, Modulation Setup, ARB, Trigger Type
Remote Command:	:SOURce:RADio:ARB:TRIGger:TYPE:CONTInuous [:TYPE] FREE TRIGger RESet :SOURce:RADio:ARB:TRIGger:TYPE:CONTInuous [:TYPE] ?
Example:	SOUR:RAD:ARB:TRIG:TYPE:CONT FREE
Preset:	FREE
Range:	Free Run Trigger + Run Reset + Run
Initial S/W Revision:	A.05.00
Help Map ID:	35455

Free Run

Selects Free Run as the trigger response for the continuous trigger type. Free Run sets the waveform generator to play a waveform sequence or segment continuously, without waiting for a trigger. In this mode, the waveform generator does not respond to triggers.

Key Path:	Source, Modulation Setup, ARB, Trigger Type, Continuous
Example:	SOUR:RAD:ARB:TRIG:TYPE:CONT FREE
Initial S/W Revision:	A.05.00
Help Map ID:	35456

Trigger + Run

Sets Trigger and Run as the trigger response for the continuous trigger type. Trigger and Run sets the waveform generator to play a waveform sequence or segment continuously when the first trigger is received, and to ignore

any subsequent triggers.

Key Path:	Source, Modulation Setup, ARB, Trigger Type, Continuous
Example:	SOUR:RAD:ARB:TRIG:TYPE:CONT TRIG
Initial S/W Revision:	A.05.00
Help Map ID:	35457

Reset + Run

Sets Reset and Run as the trigger response for the continuous trigger type. Reset and Run sets the waveform generator to play a waveform sequence or segment continuously when the first trigger is received. Subsequent triggers reset the waveform sequence or segment to the start, and then play it continuously.

Key Path:	Source, Modulation Setup, ARB, Trigger Type, Continuous
Example:	SOUR:RAD:ARB:TRIG:TYPE:CONT RES
Initial S/W Revision:	A.05.00
Help Map ID:	35458

Single

Sets the active trigger type to Single. If Single is already selected as the active trigger type, pressing this key allows access to the single trigger type setup menu. In Single trigger mode, the waveform plays once.

Key Path:	Source, Modulation Setup, ARB, Trigger Type
Remote Command:	:SOURce:RADio:ARB:RETRigger ON OFF IMMEDIATE :SOURce:RADio:ARB:RETRigger?
Example:	SOUR:RAD:ARB:RETR OFF
Notes:	ON: Buffered Trigger OFF: No Retrigger Immediate: Restart on Trigger This is defined as an enumerated SCPI command, with ON OFF being considered as enumerated types rather than Boolean. This means the query will return OFF instead of 0, and ON instead of 1.
Preset:	ON
Range:	No Retrigger Buffered Trigger Restart on Trigger
Initial S/W Revision:	A.05.00
Help Map ID:	35459

No Retrigger

Selects No Retrigger as the trigger response for single trigger type. No Retrigger sets the waveform generator to play a waveform sequence or segment once when a trigger is received. Any triggers then received during playback

Common Measurement Functions 1

are ignored.

Key Path:	Source, Modulation Setup, ARB, Trigger Type, Single
Example:	SOUR:RAD:ARB:RETR OFF
Initial S/W Revision:	A.05.00
Help Map ID:	35460

Buffered Trigger

Selects Buffered Trigger as the trigger response for single trigger type. Buffered Trigger sets the waveform generator to play a waveform sequence or segment once when a trigger is received. If a trigger is received during playback, the waveform generator plays the sequence or segment to the end, then plays the sequence or segment once more.

Key Path:	Source, Modulation Setup, ARB, Trigger Type, Single
Example:	SOUR:RAD:ARB:RETR ON
Initial S/W Revision:	A.05.00
Help Map ID:	35461

Restart on Trigger

Selects Restart on Trigger as the trigger response for single trigger type. Restart on Trigger sets the waveform generator to play a waveform sequence or segment once when a trigger is received. If a trigger is received during playback, the waveform generator resets and plays the sequence or segment from the start.

Key Path:	Source, Modulation Setup, ARB, Trigger Type, Single
Example:	SOUR:RAD:ARB:RETR IMM
Initial S/W Revision:	A.05.00
Help Map ID:	35462

Segment Advance

Sets the active trigger type to Segment Advance. If Segment Advance is already selected as the active trigger type, pressing this key allows access to the segment advance trigger type setup menu.

Segment Advance triggering allows you to control the playback of waveform segments within a waveform sequence. When a trigger is received the ARB advances to the next waveform segment within the waveform sequence. This type of triggering ignores the repetition count for the waveform segment within the waveform sequence. For example, if a waveform segment has a repetition count of 10 and you select single segment advance triggering mode, the waveform segment will only play once.

Segment Advance triggering can also be used for waveform segments only. In this situation the same waveform segment is played again when a trigger is received.

Key Path:	Source, Modulation Setup, ARB, Trigger Type
-----------	--

Remote Command:	:SOURce:RADio:ARB:TRIGger:TYPE:SADVance[:TYPE] SINGLE CONTinuous :SOURce:RADio:ARB:TRIGger:TYPE:SADVance[:TYPE]?
Example:	SOUR:RAD:ARB:TRIG:TYPE:SADV SING
Preset:	CONTinuous
Range:	Single Continuous
Initial S/W Revision:	A.05.00
Help Map ID:	35463

Single

Selects Single as the trigger response for Segment Advance trigger type. With single selected, once a trigger is received a segment is played once. If a trigger is received during playback of a segment, the segment plays to completion and the next segment is played once.

Key Path:	Source, Modulation Setup, ARB, Trigger Type, Segment Advance
Example:	SOUR:RAD:ARB:TRIG:TYPE:SADV SING
Initial S/W Revision:	A.05.00
Help Map ID:	35464

Continuous

Selects Continuous as the trigger response for Segment Advance trigger type. With continuous selected, once a trigger is received a segment is played continuously. When subsequent triggers are received, the currently playing segment plays to completion and then the next segment is played continuously.

Key Path:	Source, Modulation Setup, ARB, Trigger Type, Segment Advance
Example:	SOUR:RAD:ARB:TRIG:TYPE:SADV CONT
Initial S/W Revision:	A.05.00
Help Map ID:	35465

Trigger Source

Allows access to the trigger source sub-menus. The trigger source setting determines how the source receives the trigger that starts the waveform playing. Therefore, this key is grayed out if the trigger type is free run, since free run triggers immediately with no trigger source required.

Key Path:	Source, Modulation Setup, ARB
Remote Command:	:SOURce:RADio:ARB:TRIGger[:SOURce] KEY BUS EXTernal2 :SOURce:RADio:ARB:TRIGger[:SOURce]?
Example:	SOUR:RAD:ARB:TRIGger KEY
Dependencies:	This key is grayed out if the current trigger type is Continuous, Free Run.

Common Measurement Functions 1

Preset:	EXTernal2
Range:	Trigger Key Bus External 2
Initial S/W Revision:	A.05.00
Help Map ID:	35469

Trigger Key

Sets the current trigger source to the front panel Trigger key. When Trigger Key is selected, the waveform is triggered when you press the front panel Trigger key.

Key Path:	Source, Modulation Setup, ARB, Trigger Source
Example:	SOUR:RAD:ARB:TRIGger KEY
Initial S/W Revision:	A.05.00
Help Map ID:	35470

Bus

Sets the current trigger source to Bus. Selecting Bus trigger source enables triggering over GPIB, LAN, or USB using the :SOURce:RADio:ARB:TRIGger:INITiate command.

Key Path:	Source, Modulation Setup, ARB, Trigger Source
Example:	SOUR:RAD:ARB:TRIGger BUS
Initial S/W Revision:	A.05.00
Help Map ID:	35471

External 2

Sets the current trigger source to External 2. Selecting External 2 enables triggering a waveform by an externally applied signal.

Key Path:	Source, Modulation Setup, ARB, Trigger Source
Example:	SOUR:RAD:ARB:TRIGger EXT2
Initial S/W Revision:	A.05.00
Help Map ID:	35472

Trigger Initiate

Used to initiate an immediate trigger event if the trigger source is set to Trigger Key.

Key Path:	Source, Modulation Setup, ARB
Notes:	No remote command, SCPI front panel only.
Initial S/W Revision:	A.05.00

Help Map ID:	35475
--------------	-------

Waveform Sequences

Allows access to the waveform sequence sub-menus. Pressing this key changes the central view area to display the Waveform Sequence List view.

Key Path:	Source, Modulation Setup, ARB
Notes:	No remote command, SCPI front panel only.
Initial S/W Revision:	A.05.00
Help Map ID:	35476

Build New Sequence

Allows access to the sub-menus for creating a new waveform sequence. Pressing this key changes the central view area to display the Waveform Sequence Creation and Editing view.

Key Path:	Source, Modulation Setup, ARB, Waveform Sequences
Notes:	No remote command, SCPI front panel only.
Initial S/W Revision:	A.05.00
Help Map ID:	35477

Current Segment

Specifies the selected sequence segment that will be affected by the menu functions.

Key Path:	Source, Modulation Setup , ARB, Waveform Sequences, Build New Sequence
Notes:	No remote command, SCPI front panel only. This key is grayed out and unavailable if the sequence is currently empty.
Initial S/W Revision:	A.05.00
Help Map ID:	35478

Insert New Waveform

Allows you access to the sub-menu for inserting a new waveform segment or sequence. Pressing this key also changes the central display to show the Waveform File Selection View.

Key Path:	Source, Modulation Setup, ARB, Waveform Sequences, Build New Sequence
Notes:	No remote command, SCPI front panel only. Waveform segment name string length upper limit is 128 chars. Please do NOT insert waveform which name string exceeds 128 chars.
Initial S/W Revision:	A.05.00

Common Measurement Functions 1

Help Map ID:	35479
--------------	-------

Insert Waveform

Inserts the currently highlighted waveform to the end of the waveform sequence. Pressing this key also returns you to the menus for creating or editing a sequence, and returns the central view to the sequence creation view.

Key Path:	Source, Modulation Setup, ARB, Waveform Sequences, Build New Sequence, Insert New Waveform
Notes:	No remote command, SCPIfront panel only. Waveform segment NAME string length upper limit is 128 chars. Please do NOT insert waveform which name string exceeds 128 chars.
Initial S/W Revision:	A.05.00
Help Map ID:	35480

Segments on Hard Disk

This key functions the same as [Segments on Hard Disk@35433](#).

Key Path:	Source, Modulation Setup, ARB, Waveform Sequences, Build New Sequence, Insert New Waveform
Initial S/W Revision:	Prior to A.09.00
Help Map ID:	0

Load Segment To ARB Memory

This key functions the same as [Load Segment To ARB Memory@35434](#).

Key Path:	Source, Modulation Setup, ARB, Waveform Sequences, Build New Sequence, Insert New Waveform, Segment on Hard Drive
Initial S/W Revision:	Prior to A.09.00
Help Map ID:	0

Load All To ARB Memory

This key functions the same as [Load All To ARB Memory@35435](#).

Key Path:	Source, Modulation Setup, ARB, Waveform Sequences, Build New Sequence, Insert New Waveform, Segment on Hard Drive
Initial S/W Revision:	Prior to A.09.00
Help Map ID:	0

Change Directory ...

This key functions the same as [Change Directory...@35436](#).

Key Path:	Source, Modulation Setup, ARB, Waveform Sequences, Build New Sequence, Insert New Waveform, Segment on Hard Drive
Initial S/W Revision:	Prior to A.09.00
Help Map ID:	0

Default Directory ...

This key functions the same as [Default Directory...@35437](#).

Key Path:	Source, Modulation Setup, ARB, Waveform Sequences, Build New Sequence, Insert New Waveform, Segment on Hard Drive
Initial S/W Revision:	Prior to A.09.00
Help Map ID:	0

Segments in ARB Memory

This key functions the same as [Segments in ARB Memory@35438](#).

Key Path:	Source, Modulation Setup, ARB, Waveform Sequences, Build New Sequence, Insert New Waveform
Initial S/W Revision:	Prior to A.09.00
Help Map ID:	0

Delete Segment From ARB Memory

This key functions the same as [Delete Segment From ARB Mem@35439](#).

Key Path:	Source, Modulation Setup, ARB, Waveform Sequences, Build New Sequence, Insert New Waveform, Segment in ARB Memory
Initial S/W Revision:	Prior to A.09.00
Help Map ID:	0

Delete All From ARB Memory

This key functions the same as [Delete All From ARB Memory@35440](#).

Key Path:	Source, Modulation Setup, ARB, Waveform Sequences, Build New Sequence, Insert New Waveform, Segment in ARB Memory
Initial S/W Revision:	Prior to A.09.00
Help Map ID:	0

Common Measurement Functions 1

Query ARB Memory File List (Remote Command Only)

This command functions the same as [Query ARB Memory File List \(Remote Command Only\)@35686](#).

Initial S/W Revision:	Prior to A.09.00
Help Map ID:	0

Edit Selected Waveform

Allows access to the sub-menus for editing the details of the currently selected waveform segment.

Key Path:	Source, Modulation Setup, ARB, Waveform Sequences, Build New Sequence
Notes:	No remote command, front panel only.
Initial S/W Revision:	A.05.00
Help Map ID:	35481

Repetitions

Allows you to specify the number of times the currently selected waveform is played within the sequence.

Key Path:	Source, Modulation Setup, ARB, Waveform Sequences, Build New Sequence, Edit Selected Waveform
Notes:	No remote command, SCPI front panel only.
Preset:	1
Min:	1
Max:	65535
Initial S/W Revision:	A.05.00
Help Map ID:	35482

Marker 1

Allows you to enable or disable marker 1 for the currently selected waveform. For a waveform sequence, you can enable and disable markers on a per-segment basis, allowing you to output markers from some waveform segments within the sequence, but not for others.

Key Path:	Source, Modulation Setup, ARB, Waveform Sequences, Build New Sequence, Edit Selected Waveform
Notes:	No remote command, front panel only.
Preset:	Enabled
Range:	Enabled Disabled
Initial S/W Revision:	A.05.00
Help Map ID:	35483

Marker 2

Allows you to enable or disable marker 2 for the currently selected waveform. For a waveform sequence, you can enable and disable markers on a per-segment basis, allowing you to output markers from some waveform segments within the sequence, but not for others.

Key Path:	Source, Modulation Setup, ARB, Waveform Sequences, Build New Sequence, Edit Selected Waveform
Notes:	No remote command, front panel only.
Preset:	Enabled
Range:	Enabled Disabled
Initial S/W Revision:	A.05.00
Help Map ID:	35484

Marker 3

Allows you to enable or disable marker 3 for the currently selected waveform. For a waveform sequence, you can enable and disable markers on a per-segment basis, allowing you to output markers from some waveform segments within the sequence, but not for others.

Key Path:	Source, Modulation Setup, ARB, Waveform Sequences, Build New Sequence, Edit Selected Waveform
Notes:	No remote command, front panel only.
Preset:	Enabled
Range:	Enabled Disabled
Initial S/W Revision:	A.05.00
Help Map ID:	35485

Marker 4

Allows you to enable or disable marker 4 for the currently selected waveform. For a waveform sequence, you can enable and disable markers on a per-segment basis, allowing you to output markers from some waveform segments within the sequence, but not for others.

Key Path:	Source, Modulation Setup, ARB, Waveform Sequences, Build New Sequence, Edit Selected Waveform
Notes:	No remote command, front panel only.
Preset:	Enabled
Range:	Enabled Disabled
Initial S/W Revision:	A.05.00
Help Map ID:	35486

Common Measurement Functions 1

Delete Segment

Allows you to delete the selected segment from the waveform sequence.

Key Path:	Source, Modulation Setup, ARB, Waveform Sequences, Build New Sequence
Notes:	No remote command, front panel only.
Initial S/W Revision:	A.05.00
Help Map ID:	35487

Save Sequence...

Pressing this key displays the “Save As” dialog. The sequence name is passed to the save as dialog to use as the filename for saving, and the directory the save as dialog will open into is the default waveform directory.

Key Path:	Source, Modulation Setup, ARB, Waveform Sequences, Build New Sequence
Initial S/W Revision:	A.05.00
Help Map ID:	35488

Build New Sequence (Remote Command Only)

This command is the SCPI equivalent of the waveform sequence creation features described in [“Build New Sequence” on page 1551](#).

This command writes a waveform sequence file to the hard disk. You must specify the waveform sequence file path and filename which will be saved on the hard disk, and the waveform segment file path and name which will be nested into the waveform sequence file. You can utilize mass storage unit specifier (MSUS) “NVWFM” or use a real full path representation. See the example below. MSUS “NVWFM” is mapped to D:\NVARB directory on test set hard disk.

Any number of segments, up to a segment count limit of 64, can be used to create a sequence. Repeated segments are included in the count limit.

Each waveform segment name string length upper limit is 128 chars. Please do NOT insert waveform which name string exceeds 128 chars.

The internal source does not support nesting one waveform sequence file into another waveform sequence file.

Remote Command:	<pre>:SOURce:RADio:ARB:SEquence[:MWAVeform] <filename>, <waveform1>, <reps>, NONE M1 M2 M3 M4 M1M2 M1M3 M1M4 M2M3 M2M4 M3M4 M1M2M3 M 1M2M4 M1M3M4 M2M3M4 M1M2M3M4 ALL, {<waveform2>, <reps>, NONE M1 M2 M3 M4 M1M2 M1M3 M1M4 M2M3 M2M4 M3M4 M1M2M3 M 1M2M4 M1M3M4 M2M3M4 M1M2M3M4 ALL, } ...</pre> <p>(For additional description of each item, see Notes below “For Setup SCPI” on page 1558“For Setup SCPI”.)</p> <pre>:SOURce:RADio:ARB:SEquence[:MWAVeform]? <filename></pre> <p>(For additional description of each item, see Notes “For Query SCPI” on page 1559 below.)</p>
------------------------	--

Example:	<p>For setup:</p> <p>SOUR:RAD:ARB:SEQ "NVWFM:testSeq1.seq", "NVWFM:wfmSegment1.wfm",10, M2M3M4, "NVWFM:wfmSegment2.wfm", 20, M1M3</p> <p>Or</p> <p>SOUR:RAD:ARB:SEQ "D:\NVARB\testSeq1.seq", " D:\NVARB\wfmSegment1.wfm",10, M2M3M4, " D:\NVARB\wfmSegment2.wfm", 20, M1M3</p> <p>For query, must specify which waveform sequence file to query.</p> <p>SOUR:RAD:ARB:SEQ? "NVWFM:testSeq1.seq"</p> <p>Or</p> <p>SOUR:RAD:ARB:SEQ? "D:\NVARB\testSeq1.seq",</p>
----------	--

<p>Notes:</p>	<p>For Setup SCPI</p> <p>For the Setup SCPI command, the parameters are:</p> <p><filename> - String Type</p> <p>This variable specifies the path and name for the waveform sequence file. The path supports MSUS (NVWFM) or a real full path representation. See example.</p> <p><waveform1> - String Type</p> <p>This variable specifies the path and name of the first existing waveform segment. The path supports MSUS (NVWFM) or a real full path representation. See example.</p> <p>The segment file must reside within ARB playback memory before it can be played by the ARB player.</p> <p><reps> - Integer Type</p> <p>This variable specifies the number of times a segment or sequence plays before moving on to the next segment or sequence.</p> <p><marker> - Enum Type</p> <p>NONE – This choice disables all four markers for the waveform. Disabling markers means that the waveform sequence ignores the segments or sequence marker settings.</p> <p>M1, M2, M3, M4 – these choices, either individually or a combination of them, enable the markers for the waveform segment or sequence. Markers not specified are ignored for that segment or sequence.</p> <p>ALL – This choice enables all four markers in the waveform segment or sequence.</p> <p><waveform2> - String type.</p> <p>This variable specifies the name of a second existing waveform segment. The path supports MSUS (NVWFM) and real full path representation both. See example.</p> <p>The segment file must reside within ARB playback memory before it can be played by the ARB player.</p> <p><reps> same as above, for the 2nd waveform segment.</p> <p><marker> same as above, for the 2nd waveform segment.</p> <p>You can insert several waveform segments into a waveform sequence file. Just repeat inserting waveform segments as described above.</p> <p>Error Checks for Setup SCPI command:</p> <p>If you do not specify a filename, or you use an unsupported MSUS (that is, not NVWFM), or have an error in the waveform sequence file path, an error is generated.</p>
---------------	--

Notes:	<p>Error Checks for Query SCPI command: (Continued)</p> <p>If the specified waveform sequence file name suffix is not “.seq”, error is generated.</p> <p>If you use an unsupported MSUS (that is, not NVWFM), or have an error in the waveform segment file path, an error is generated.</p> <p>If the first specified waveform file cannot be found, an error is generated.</p> <p>If you nest one waveform sequence file into another waveform sequence file, an error is generated.</p> <p>If the specified repetition value is larger than 65535 or smaller than 1, an error is generated.</p> <p>If the specified marker type is unrecognized, an error is generated.</p> <p>For Query SCPI</p> <p>For the Query the parameters are:</p> <p><filename> - String type.</p> <p>This variable specifies the path and name of the waveform sequence file being queried. The path supports MSUS (NVWFM) or a real full path representation. See example.</p> <p>The return value is a <string>, which includes each waveform segment file name, repetitions, and marker type. For example:</p> <p>SOUR:RAD:ARB:SEQ? “NVWFM:testSeq1.seq”,</p> <p><“wfmSegment1. wfm, 10, ALL, wfmSegment2.wfm, 20, M1M3”</p> <p>Error Checks for Query SCPI command:</p> <p>If you do not specify a filename, an error is generated.</p> <p>If the waveform sequence file name is empty, an error is generated.</p> <p>If the specified waveform sequence file cannot be found, an error is generated.</p>
Initial S/W Revision:	A.05.00
Help Map ID:	35687

Edit Selected Sequence

Allows access to the sub-menus for editing the sequence currently selected within the Waveform Sequence List view. Pressing this key changes the central view area to display the Waveform Sequence Creation and Editing view.

Key Path:	Source, Modulation Setup, ARB, Waveform Sequences
Notes:	No remote command, front panel only.
Initial S/W Revision:	A.05.00
Help Map ID:	35489

Common Measurement Functions 1

Current Segment

Specifies the selected sequence segment that will be affected by the menu functions.

Key Path:	Source, Modulation Setup, ARB, Waveform Sequences, Edit Selected Sequence
Notes:	No remote command, front panel only. This key is grayed out and unavailable if the sequence is currently empty.
Initial S/W Revision:	A.05.00
Help Map ID:	35490

Insert New Waveform

Allows you access to the sub-menu for inserting a new waveform segment or sequence. Pressing this key also changes the central display to show the Waveform File Selection View.

Key Path:	Source, Modulation Setup, ARB, Waveform Sequences, Edit Selected Sequence
Notes:	No remote command, front panel only.
Initial S/W Revision:	A.05.00
Help Map ID:	35491

Insert Waveform

Inserts the currently highlighted waveform to the end of the waveform sequence. Pressing this key also returns you to the menus for creating or editing a sequence, and returns the central view to the sequence creation view.

Key Path:	Source, Modulation Setup, ARB, Waveform Sequences, Edit Selected Sequence, Insert New Waveform
Notes:	No remote command, front panel only.
Initial S/W Revision:	A.05.00
Help Map ID:	35492

Segments on Hard Disk

This key functions the same as section [Segments on Hard Disk@35433@i](#).

Key Path:	Source, Modulation Setup, ARB, Waveform Sequences, Edit Selected Sequence, Insert New Waveform
Initial S/W Revision:	Prior to A.09.00
Help Map ID:	0

Load Segment To ARB Memory

This key functions the same as section [Load Segment To ARB Memory@35434@i.](#)

Key Path:	Source, Modulation Setup, ARB, Waveform Sequences, Edit Selected Sequence, Insert New Waveform, Segments on Hard Disk
Initial S/W Revision:	Prior to A.09.00
Help Map ID:	0

Load All To ARB Memory

This key functions the same as section [Load All To ARB Memory@35435@i.](#)

Key Path:	Source, Modulation Setup, ARB, Waveform Sequences, Edit Selected Sequence, Insert New Waveform, Segments on Hard Disk
Initial S/W Revision:	Prior to A.09.00
Help Map ID:	0

Change Directory ...

This key functions the same as section [Change Directory...@35436@i.](#)

Key Path:	Source, Modulation Setup, ARB, Waveform Sequences, Edit Selected Sequence, Insert New Waveform, Segments on Hard Disk
Initial S/W Revision:	Prior to A.09.00
Help Map ID:	0

Default Directory ...

This key functions the same as section [Default Directory...@35437@i](#)

Key Path:	Source, Modulation Setup, ARB, Waveform Sequences, Edit Selected Sequence, Insert New Waveform, Segments on Hard Disk
Initial S/W Revision:	Prior to A.09.00
Help Map ID:	0

Segments in ARB Memory

This key functions the same as section [Segments in ARB Memory@35438@i.](#)

Key Path:	Source, Modulation Setup, ARB, Waveform Sequences, Edit Selected Sequence, Insert New Waveform
Initial S/W Revision:	Prior to A.09.00
Help Map ID:	0

Common Measurement Functions 1

Delete Segment From ARB Memory

This key functions the same as section [Delete Segment From ARB Mem@35439@i](#).

Key Path:	Source, Modulation Setup, ARB, Waveform Sequences, Edit Selected Sequence, Insert New Waveform, Segments in ARB Memory
Initial S/W Revision:	Prior to A.09.00
Help Map ID:	0

Delete All From ARB Memory

This key functions the same as section [Delete All From ARB Memory@35440@i](#).

Key Path:	Source, Modulation Setup, ARB, Waveform Sequences, Edit Selected Sequence, Insert New Waveform, Segments in ARB Memory
Initial S/W Revision:	Prior to A.09.00
Help Map ID:	0

Query ARB Memory File List (Remote Command Only)

This key functions the same as section Query [ARB Memory File List \(Remote Command Only\)@35686@i](#)

Key Path:	Source, Modulation Setup, ARB, Waveform Sequences, Edit Selected Sequence, Insert New Waveform, Segments in ARB Memory
Initial S/W Revision:	Prior to A.09.00
Help Map ID:	0

Edit Selected Waveform

Allows access to the sub-menus for editing the details of the currently selected waveform segment.

Key Path:	Source, Modulation Setup, ARB, Waveform Sequences, Edit Selected Sequence
Notes:	No remote command, front panel only.
Initial S/W Revision:	A.05.00
Help Map ID:	35493

Repetitions

Allows you to specify the number of times the currently selected waveform is played within the sequence.

Key Path:	Source, Modulation Setup, ARB, Waveform Sequences, Edit Selected Sequence, Edit Selected Waveform
Notes:	No remote command, front panel only.
Preset:	1

Min:	1
Max:	TBD
Initial S/W Revision:	A.05.00
Help Map ID:	35494

Marker 1

Allows you to enable or disable marker 1 for the currently selected waveform. For a waveform sequence, you can enable and disable markers on a per-segment basis, allowing you to output markers from some waveform segments within the sequence but not for others.

Key Path:	Source, Modulation Setup, ARB, Waveform Sequences, Edit Selected Sequence, Edit Selected Waveform
Notes:	No remote command, front panel only.
Preset:	Enabled
Range:	Enabled Disabled
Initial S/W Revision:	A.05.00
Help Map ID:	35495

Marker 2

Allows you to enable or disable marker 2 for the currently selected waveform. For a waveform sequence, you can enable and disable markers on a per-segment basis, allowing you to output markers from some waveform segments within the sequence but not for others.

Key Path:	Source, Modulation Setup, ARB, Waveform Sequences, Edit Selected Sequence, Edit Selected Waveform
Notes:	No remote command, front panel only.
Preset:	Enabled
Range:	Enabled Disabled
Initial S/W Revision:	A.05.00
Help Map ID:	35496

Marker 3

Allows you to enable or disable marker 3 for the currently selected waveform. For a waveform sequence, you can enable and disable markers on a per-segment basis, allowing you to output markers from some waveform segments within the sequence but not for others.

Key Path:	Source, Modulation Setup, ARB, Waveform Sequences, Edit Selected Sequence, Edit Selected Waveform
Notes:	No remote command, front panel only.
Preset:	Enabled

Common Measurement Functions 1

Range:	Enabled Disabled
Initial S/W Revision:	A.05.00
Help Map ID:	35497

Marker 4

Allows you to enable or disable marker 4 for the currently selected waveform. For a waveform sequence, you can enable and disable markers on a per-segment basis, allowing you to output markers from some waveform segments within the sequence but not for others.

Key Path:	Source, Modulation Setup, ARB, Waveform Sequences, Edit Selected Sequence, Edit Selected Waveform
Notes:	No remote command, front panel only.
Preset:	Enabled
Range:	Enabled Disabled
Initial S/W Revision:	A.05.00
Help Map ID:	35498

Delete Segment

Allows you to delete the current segment from the waveform sequence.

Key Path:	Source, Modulation Setup, ARB, Waveform Sequences, Edit Selected Sequence
Notes:	No remote command, front panel only.
Initial S/W Revision:	A.05.00
Help Map ID:	35499

Save Sequence...

Pressing this key displays the “Save As” dialog box. The sequence name is passed to the save as dialog to use as the filename for saving, and the directory the save as dialog opens into is the default waveform directory.

Key Path:	Source, Modulation Setup, ARB, Waveform Sequences, Edit Selected Sequence
Notes:	No remote command, front panel only.
Initial S/W Revision:	A.05.00
Help Map ID:	35500

Current Directory...

Allows you to change the currently selected directory on the hard disk. Pressing this key opens a standard windows

change directory dialog and allows you to select the new directory of interest.

Key Path:	Source, Modulation Setup, ARB, Waveform Sequences
Notes:	No remote command, front panel only.
Initial S/W Revision:	A.05.00
Help Map ID:	35501

Waveform Utilities

Allows you access to the waveform utilities sub-menus.

Key Path:	Source, Modulation Setup, ARB
Initial S/W Revision:	A.05.00
Help Map ID:	35502

Multi-Pack Licenses

Allows you access to the Multi - Pack License sub-menus. Pressing this key also changes the central view area to display the Multi -Pack License Management view.

Key Path:	Source, Modulation Setup, ARB, Waveform Utilities
Dependencies:	This key is only available if there is at least one Multi-pack license installed on the instrument.
Initial S/W Revision:	A.05.00
Help Map ID:	35503

Add Waveform

Pressing this key accesses the Add Waveform sub-menu. It also changes the central display area to display the Multi-Pack License Waveform Add view.

Key Path:	Source, Modulation Setup, ARB, Waveform Utilities, Multi-Pack Licenses
Dependencies:	This key is only available if there is at least one slot available within at least one multi-pack license.
Initial S/W Revision:	A.05.00
Help Map ID:	35504

Add Waveform

Allows you to add the currently selected waveform segment to a multi-pack license. The new waveform is added to the next available slot regardless of which slot was selected on the Multi-Pack License Management view.

Key Path:	Source, Modulation Setup, ARB, Waveform Utilities, Multi-Pack Licenses, Add Waveform
-----------	---

Common Measurement Functions 1

Remote Command:	:SYSTem:LKEY:WAVEform:ADD <string> or :SYSTem:LIcense[:FPACK]:WAVEform:ADD <string>
Example:	SYST:LKEY:WAV:ADD "mywaveform.wfm" or SYST:LIC:WAV:ADD "mywaveform.wfm"
Notes:	The second SCPI :SYSTem:LIcense[:FPACK]:WAVEform:ADD is provided to be consistent with the style of Agilent signal sources. You can use either one of them. Since adding a waveform segment to a Multi-Pack license causes the license slot to enter the trial period of only 48 hours, pressing this key causes a confirmation dialog to be displayed to ensure you do want to add the waveform segment to the Multi-Pack. If you attempt to license a waveform that is already licensed using another slot an error is generated.
Dependencies:	This key is only available if the currently selected file is a secure waveform requiring a license, and there is at least one slot available within at least one multi-pack license. If the waveform highlighted is a secure waveform, but is already licensed, this key will be unavailable.
Initial S/W Revision:	A.05.00
Help Map ID:	35659

Segments on Hard Disk

This key functions the same as [Segments on Hard Disk@35433](#).

Key Path:	Source, Modulation Setup, ARB, Waveform Utilities, Multi-Pack Licenses, Add Waveform
Initial S/W Revision:	Prior to A.09.00
Help Map ID:	0

Load Segment To ARB Memory

This key functions the same as [Load Segment To ARB Memory@35434](#).

Key Path:	Source, Modulation Setup, ARB, Waveform Utilities, Multi-Pack Licenses, Add Waveform, Segment on Hard Drive
Initial S/W Revision:	Prior to A.09.00
Help Map ID:	0

Load All To ARB Memory

This key functions the same as [Load All To ARB Memory@35435](#).

Key Path:	Source, Modulation Setup, ARB, Waveform Utilities, Multi-Pack Licenses, Add Waveform, Segment on Hard Drive
Initial S/W Revision:	Prior to A.09.00
Help Map ID:	0

Change Directory ...

This key functions the same as [Change Directory...@35436](#).

Key Path:	Source, Modulation Setup, ARB, Waveform Utilities, Multi-Pack Licenses, Add Waveform, Segment on Hard Drive
Initial S/W Revision:	Prior to A.09.00
Help Map ID:	0

Default Directory ...

This key functions the same as [Default Directory...@35437](#)

Key Path:	Source, Modulation Setup, ARB, Waveform Utilities, Multi-Pack Licenses, Add Waveform, Segment on Hard Drive
Initial S/W Revision:	Prior to A.09.00
Help Map ID:	0

Replace Waveform

Pressing this key accesses the Replace Waveform submenu. It also changes the central display area to display the Multi-Pack License Waveform Add view.

Key Path:	Source, Modulation Setup, ARB, Waveform Utilities, Multi-Pack Licenses
Dependencies:	This key is only available if the currently selected slot is in the trial state.
Initial S/W Revision:	A.05.00
Help Map ID:	35661

Replace Waveform

Allows you to replace the waveform in the currently selected slot with the waveform currently selected in the Multi-Pack License Waveform Add view.

Key Path:	Source, Modulation Setup, ARB, Waveform Utilities, Multi-Pack Licenses, Replace Waveform
-----------	---

Common Measurement Functions 1

Remote Command:	:SYSTem:LKEY:WAVEform:REPLace <int>, <string> or :SYSTem:LIcense[:FPACK]:WAVEform:REPLace <int>, <string>
Example:	SYST:LKEY:WAV:REPL 1, "myotherwaveform.wfm" or :SYST:LIC:WAV:REPL 1, "myotherwaveform.wfm"
Notes:	The second SCPI :SYSTem:LIcense[:FPACK]:WAVEform:REPLace is provided to be consistent with the style of Agilent signal sources. You can use either one of them. If you attempt to license a waveform that is already licensed using another slot an error is generated. Waveform slot number <int> is positive. If you attempt to input a slot number less than or equals 0, an error is generated. "-220 Parameter error; License slot <n> is illegal, slot number must be positive"
Initial S/W Revision:	A.05.00
Help Map ID:	35662

Segments on Hard Disk

This key functions the same as [Segments on Hard Disk@35433](#).

Key Path:	Source, Modulation Setup, ARB, Waveform Utilities, Multi-Pack Licenses, Replace Waveform
Initial S/W Revision:	Prior to A.09.00
Help Map ID:	0

Load Segment To ARB Memory

This key functions the same as [Load Segment To ARB Memory@35434](#).

Key Path:	Source, Modulation Setup, ARB, Waveform Utilities, Multi-Pack Licenses, Replace Waveform, Segment on Hard Drive
Initial S/W Revision:	Prior to A.09.00
Help Map ID:	0

Load All To ARB Memory

This key functions the same as [Load All To ARB Memory@35435](#).

Key Path:	Source, Modulation Setup, ARB, Waveform Utilities, Multi-Pack Licenses, Replace Waveform, Segment on Hard Drive
Initial S/W Revision:	Prior to A.09.00

Help Map ID:	0
--------------	---

Change Directory ...

This key functions the same as [Change Directory...@35436](#).

Key Path:	Source, Modulation Setup, ARB, Waveform Utilities, Multi-Pack Licenses, Replace Waveform, Segment on Hard Drive
Initial S/W Revision:	Prior to A.09.00
Help Map ID:	0

Default Directory ...

This key functions the same as [Default Directory...@35437](#)

Key Path:	Source, Modulation Setup, ARB, Waveform Utilities, Multi-Pack Licenses, Replace Waveform, Segment on Hard Drive
Initial S/W Revision:	Prior to A.09.00
Help Map ID:	0

Clear Waveform from Slot

Allows you to clear the waveform from the selected slot.

Key Path:	Source, Modulation Setup, ARB, Waveform Utilities, Multi-Pack Licenses
Remote Command:	:SYSTem:LKEY:WAVEform:CLEar <int> or :SYSTem:LIcense[:FPACK]:WAVEform:CLEar <int>
Example:	SYST:LKEY:WAV:CLE 1 or :SYST:LIC:WAV:CLE 1
Notes:	The second SCPI :SYSTem:LIcense[:FPACK]:WAVEform:CLEar is provided to be consistent with the style of Agilent signal sources. You can use either one of them. Waveform slot number <int> is positive. If you attempt to input a slot number less than or equals 0, an error is generated. "-220 Parameter error; License slot <n> is illegal, slot number must be positive"
Dependencies:	This key is only available if the currently selected slot is in the trial state.
Initial S/W Revision:	A.05.00
Help Map ID:	35664

Lock Waveform in Slot

If the selected slot is in the trial state or the lock required state, the waveform that occupies the slot is locked and

Common Measurement Functions 1

permanently licensed.

Key Path:	Source, Modulation Setup, ARB, Waveform Utilities, Multi-Pack Licenses
Remote Command:	:SYSTem:LKEY:WAVEform:LOCK <int> or :SYSTem:LIcense[:FPACK]:WAVEform:LOCK <int>
Example:	SYST:LKEY:WAV:LOCK 1 or SYST:LIC:WAV:LOCK 1
Notes:	The second SCPI :SYSTem:LIcense[:FPACK]:WAVEform:LOCK is provided to be consistent with the style of Agilent signal sources. You can use either one of them. Waveform slot number <int> is positive. If you attempt to input a slot number less than or equals 0, an error is generated. "-220 Parameter error; License slot <n> is illegal, slot number must be positive"
Dependencies:	This key is only available if the currently selected slot is in the trial state or the lock required state.
Initial S/W Revision:	A.05.00
Help Map ID:	35665

Slot Status Query (Remote Command Only)

Returns the status of the specified slot.

Remote Command:	:SYSTem:LKEY:WAVEform:STATus? <int> or :SYSTem:LIcense[:FPACK]:WAVEform:STATus? <int>
Example:	:SYST:LKEY:WAV:STAT? 1 <"Locked" or :SYST:LIC:WAV:STAT? 1 <"Locked"
Notes:	The second SCPI :SYSTem:LIcense[:FPACK]:WAVEform:STATus is provided to be consistent with the style of Agilent signal sources. You can use either one of them. Waveform slot number <int> is positive. If you attempt to input a slot number less than or equals 0, an error is generated. "-220 Parameter error; License slot <n> is illegal, slot number must be positive" Result type is string. If input slot number exceeds total available slot number, "Nonexistent" is returned.

Range:	"Locked" "Available" "Trail" "LockRequired" "Nonexistent"
Initial S/W Revision:	A.05.00
Help Map ID:	35688

Slots Free Query (Remote Command Only)

Returns the number of license slots free.

Remote Command:	:SYSTem:LKEY:WAVeform:FREE? or :SYSTem:LICense[:FPACK]:WAVeform:FREE?
Example:	:SYST:LKEY:WAV:FREE? or :SYST:LIC:WAV:FREE?
Notes:	The second SCPI :SYSTem:LICense[:FPACK]:WAVeform:FREE is provided to be consistent with the style of Agilent signal sources. You can use either one of them.
Initial S/W Revision:	A.05.00
Help Map ID:	35689

Slot Used Query (Remote Command Only)

Returns the number of license slots used.

Remote Command:	:SYSTem:LKEY:WAVeform:USED? or :SYSTem:LICense[:FPACK]:WAVeform:USED?
Example:	:SYST:LKEY:WAV:USED? or :SYST:LIC:WAV:USED?
Notes:	The second SCPI :SYSTem:LICense[:FPACK]:WAVeform:USED is provided to be consistent with the style of Agilent signal sources. You can use either one of them.
Initial S/W Revision:	A.05.00
Help Map ID:	35690

Common Measurement Functions 1

Slot Waveform Name Query (Remote Command Only)

Returns the waveform name of the specified slot

Remote Command:	:SYSTem:LKEY:WAVeform:NAME? <int> or :SYSTem:LIcense[:FPACK]:WAVeform:NAME? <int>
Example:	:SYST:LKEY:WAV:NAME? 1 <"CDMA2K_22.wfm" or :SYST:LIC:WAV:NAME? 1 <"CDMA2K_22.wfm"
Notes:	Waveform slot number <int> is positive. If you attempt to input a slot number less than or equals 0, an error is generated. "-220 Parameter error; License slot <n> is illegal, slot number must be positive". Result type is string. If input slot number exceeds total available slot number, "Nonexistent" is returned. If no waveform stored in the specified slot, then empty string is returned.
Initial S/W Revision:	A.12.00
Help Map ID:	0

Slot Waveform Unique ID Query (Remote Command Only)

Returns the waveform unique ID of the specified slot.

Remote Command:	:SYSTem:LKEY:WAVeform:UID? <int> or :SYSTem:LIcense[:FPACK]:WAVeform:UID? <int>
Example:	:SYST:LKEY:WAV:UID? 2 <"1346752140" or :SYST:LIC:WAV:UID? 2 <"1346752140"
Notes:	Waveform slot number <int> is positive. If you attempt to input a slot number less than or equals 0, an error is generated. "-220 Parameter error; License slot <n> is illegal, slot number must be positive". Result type is string. If input slot number exceeds total available slot number, "Nonexistent" is returned. Only Signal Studio waveform has unique ID, which is a positive number. (User generated waveform has no unique ID). If no waveform stored in the specified slot, then "0" is returned

Initial S/W Revision:	A.12.00
Help Map ID:	0

Locked Waveform Name List Query (Remote Command Only)

Returns the waveform name list of locked.

Remote Command:	:SOURce:RADio:ARB:MPLicensed:NAME:LOCKed?
Example:	SOUR:RAD:ARB:MPL:NAME:LOCKed? <"CDMA2K_27.wfm","GSM_MCS1.WFM","c2kWfm.wfm"
Initial S/W Revision:	A.11.00
Help Map ID:	0

Locked Waveform Unique ID List Query (Remote Command Only)

Returns the waveform unique id list of locked.

Remote Command:	:SOURce:RADio:ARB:MPLicensed:UID:LOCKed?
Example:	SOUR:RAD:ARB:MPL:UID:LOCKed? <"2996927136","3812603511","3710986266"
Notes:	Each Signal Studio waveform has a unique id recorded in header. So if the unique ids are same, that means they are same one waveform. So besides SCPI to query locked waveform name list, also provide a SCPI to query locked waveform unique id list
Initial S/W Revision:	A.11.00
Help Map ID:	0

Marker Utilities

Allows access to the marker utilities sub-menus.

Key Path:	Source, Modulation Setup, ARB
Initial S/W Revision:	A.05.00
Help Map ID:	35505

Marker Polarity

Allows access to the marker polarity sub-menu, which allows you to specify the polarity for the four markers. For a positive polarity, the marker signal is high during the marker points. For a negative marker polarity, the marker signal is high during the period of no marker points.

Key Path:	Source, Modulation Setup, ARB, Marker Utilities
Initial S/W Revision:	A.05.00

Common Measurement Functions 1

Help Map ID:	35506
--------------	-------

Mkr 1 Polarity

Allows you to set the polarity of marker 1.

Key Path:	Source, Modulation Setup, ARB, Marker Utilities, Marker Polarity
Remote Command:	:SOURce:RADio:ARB:MPOLarity:MARKer1 POSitive NEGative :SOURce:RADio:ARB:MPOLarity:MARKer1?
Example:	SOUR:RAD:ARB:MPOL:MARK1 NEG
Dependencies:	When a new waveform is selected for playback the settings contained within the associated waveform header file are applied to the ARB. The marker polarity is one of the values stored within the header file. If the newly selected waveform file has an associated header file, the marker polarity is updated with the value from the header file. The marker polarity will remain unchanged if the newly selected waveform does not have an associated header file.
Preset:	Pos
Range:	Neg Pos
Initial S/W Revision:	A.05.00
Help Map ID:	35507

Mkr 2 Polarity

Allows you to set the polarity of marker 2.

Key Path:	Source, Modulation Setup, ARB, Marker Utilities, Marker Polarity
Remote Command:	:SOURce:RADio:ARB:MPOLarity:MARKer2 POSitive NEGative :SOURce:RADio:ARB:MPOLarity:MARKer2?
Example:	SOUR:RAD:ARB:MPOL:MARK2 NEG
Dependencies:	When a new waveform is selected for playback the settings contained within the associated waveform header file are applied to the ARB. The marker polarity is one of the values stored within the header file. If the newly selected waveform file has an associated header file, the marker polarity is updated with the value from the header file. The marker polarity will remain unchanged if the newly selected waveform does not have an associated header file.
Preset:	Pos
Range:	Neg Pos
Initial S/W Revision:	A.05.00
Help Map ID:	35508

Mkr 3 Polarity

Allows you to set the polarity of marker 3.

Key Path:	Source, Modulation Setup, ARB, Marker Utilities, Marker Polarity
Remote Command:	:SOURce:RADio:ARB:MPOLarity:MARKer3 POSitive NEGative :SOURce:RADio:ARB:MPOLarity:MARKer3?
Example:	SOUR:RAD:ARB:MPOL:MARK3 NEG
Dependencies:	When a new waveform is selected for playback the settings contained within the associated waveform header file are applied to the ARB. The marker polarity is one of the values stored within the header file. If the newly selected waveform file has an associated header file, the marker polarity is updated with the value from the header file. The marker polarity will remain unchanged if the newly selected waveform does not have an associated header file.
Preset:	Pos
Range:	Neg Pos
Initial S/W Revision:	A.05.00
Help Map ID:	35509

Mkr 4 Polarity

Allows you to set the polarity of marker 4.

Key Path:	Source, Modulation Setup, ARB, Marker Utilities, Marker Polarity
Remote Command:	:SOURce:RADio:ARB:MPOLarity:MARKer4 POSitive NEGative :SOURce:RADio:ARB:MPOLarity:MARKer4?
Example:	SOUR:RAD:ARB:MPOL:MARK4 NEG
Dependencies:	When a new waveform is selected for playback the settings contained within the associated waveform header file are applied to the ARB. The marker polarity is one of the values stored within the header file. If the newly selected waveform file has an associated header file, the marker polarity is updated with the value from the header file. The marker polarity will remain unchanged if the newly selected waveform does not have an associated header file.
Preset:	Pos
Range:	Neg Pos
Initial S/W Revision:	A.05.00
Help Map ID:	35510

Marker Routing

Allows access to the marker routing sub-menus, which allow you to specify where the marker events are routed. It

Common Measurement Functions 1

should be noted that the markers can also be routed to Trigger 1 Out and Trigger 2 Out, however this must be set up using the menus accessed by pressing the “Trigger” hard key.

Key Path:	Source, Modulation Setup, ARB, Marker Utilities
Initial S/W Revision:	A.05.00
Help Map ID:	35511

Pulse/RF Blank

Allows you to select which marker is used for the pulse/RF blanking function. The pulse/RF blanking function blanks the RF when the marker signal goes low. The marker polarity determines when the marker signal is high. For a positive polarity, this is during the marker points. For a negative polarity, this is when there are no marker points.

Marker points should be set before using this function. Enabling this function without setting maker points may create a continuous low or high signal, dependant on the marker polarity. This causes either no RF output, or a continuous RF output.

Key Path:	Source, Modulation Setup, ARB, Marker Utilities, Marker Routing
Remote Command:	:SOURce:RADio:ARB:MDEStination:PULSe NONE M1 M2 M3 M4 :SOURce:RADio:ARB:MDEStination:PULSe?
Example:	SOUR:RAD:ARB:MDES:PULS NONE
Dependencies:	When a new waveform is selected for playback the settings contained within the associated waveform header file are applied to the ARB. The pulse/RF blanking setting is one of the values stored within the header file. If the newly selected waveform file has an associated header file, the pulse/RF blanking setting is updated with the value from the header file. The pulse/RF blanking setting will remain unchanged if the newly selected waveform does not have an associated header file.
Range:	None M1 M2 M3 M4
Initial S/W Revision:	A.05.00
Help Map ID:	35512

None

Sets no marker to be used for the pulse/RF blanking function, essentially turning the RF blanking function off.

Key Path:	Source, Modulation Setup, ARB, Marker Utilities, Marker Routing, Pulse/RF Blank
Example:	SOUR:RAD:ARB:MDES:PULS NONE
Initial S/W Revision:	A.05.00
Help Map ID:	35513

Marker 1

Sets marker 1 to be used for the pulse/RF blanking function.

Key Path:	Source, Modulation Setup, ARB, Marker Utilities, Marker Routing, Pulse/RF Blank
Example:	SOUR:RAD:ARB:MDES:PULS M1
Initial S/W Revision:	A.05.00
Help Map ID:	35514

Marker 2

Sets marker 2 to be used for the pulse/RF blanking function.

Key Path:	Source, Modulation Setup, ARB, Marker Utilities, Marker Routing, Pulse/RF Blank
Example:	SOUR:RAD:ARB:MDES:PULS M2
Initial S/W Revision:	A.05.00
Help Map ID:	35515

Marker 3

Sets marker 3 to be used for the pulse/RF blanking function.

Key Path:	Source, Modulation Setup, ARB, Marker Utilities, Marker Routing, Pulse/RF Blank
Example:	SOUR:RAD:ARB:MDES:PULS M3
Initial S/W Revision:	A.05.00
Help Map ID:	35516

Marker 4

Sets marker 4 to be used for the pulse/RF blanking function.

Key Path:	Source, Modulation Setup, ARB, Marker Utilities, Marker Routing, Pulse/RF Blank
Example:	SOUR:RAD:ARB:MDES:PULS M4
Initial S/W Revision:	A.05.00
Help Map ID:	35517

ALC Hold

Allows you to specify which marker is routed for use within the ALC hold function. The ALC hold marker function holds the ALC circuitry at the average value of the sample points set by the marker.

The ALC hold function operates during the low periods of the marker signal. The marker polarity determines when the marker signal is high. For positive polarity, this is during the marker points. For a negative polarity, this is when

Common Measurement Functions 1

there are no maker points.

Key Path:	Source, Modulation Setup, ARB, Marker Utilities, Marker Routing
Remote Command:	:SOURce:RADio:ARB:MDEStination:ALCHold NONE M1 M2 M3 M4 :SOURce:RADio:ARB:MDEStination:ALCHold?
Example:	SOUR:RAD:ARB:MDES:ALCH NONE
Dependencies:	When a new waveform is selected for playback the settings contained within the associated waveform header file are applied to the ARB. The ALC hold setting is one of the values stored within the header file. If the newly selected waveform file has an associated header file, the ALC hold setting is updated with the value from the header file. The ALC hold setting will remain unchanged if the newly selected waveform does not have an associated header file.
Range:	None M1 M2 M3 M4
Initial S/W Revision:	A.05.00
Help Map ID:	35518

None

Sets no marker to be used for the ALC hold function, essentially turning the ALC hold function off.

Key Path:	Source, Modulation Setup, ARB, Marker Utilities, Marker Routing, ALC Hold
Example:	SOUR:RAD:ARB:MDES:PULS NONE
Initial S/W Revision:	A.05.00
Help Map ID:	35519

Marker 1

Sets marker 1 to be used for the ALC hold function.

Key Path:	Source, Modulation Setup, ARB, Marker Utilities, Marker Routing, ALC Hold
Example:	SOUR:RAD:ARB:MDES:PULS M1
Initial S/W Revision:	A.05.00
Help Map ID:	35520

Marker 2

Sets marker 2 to be used for the ALC hold function.

Key Path:	Source, Modulation Setup, ARB, Marker Utilities, Marker Routing, ALC Hold
-----------	--

Example:	SOUR:RAD:ARB:MDES:PULS M2
Initial S/W Revision:	A.05.00
Help Map ID:	35521

Marker 3

Sets marker 3 to be used for the ALC hold function.

Key Path:	Source, Modulation Setup, ARB, Marker Utilities, Marker Routing, ALC Hold
Example:	SOUR:RAD:ARB:MDES:PULS M3
Initial S/W Revision:	A.05.00
Help Map ID:	35522

Marker 4

Sets marker 4 to be used for the ALC hold function.

Key Path:	Source, Modulation Setup, ARB, Marker Utilities, Marker Routing, ALC Hold
Example:	SOUR:RAD:ARB:MDES:PULS M4
Initial S/W Revision:	A.05.00
Help Map ID:	35523

Header Utilities

Allows access to the header utilities sub-menu. Pressing this key also causes the central display area to change to display the File Header Information view.

Key Path:	Source, Modulation Setup, ARB
Dependencies:	This key is only available if there is currently a waveform selected for playback. If no waveform is selected, the key is grayed out.
Initial S/W Revision:	A.05.00
Help Map ID:	35536

Clear Header

Allows you to clear the header information from the file header associated with the currently selected waveform.

Key Path:	Source, Modulation Setup, ARB, Header Utilities
Remote Command:	:SOURce:RADio:ARB:HEADer:CLEar
Example:	SOUR:RAD:ARB:HEAD:CLE

Common Measurement Functions 1

Notes:	Attempting to clear the header details via SCPI when no waveform was selected for playback will generate an error.
Initial S/W Revision:	A.05.00
Help Map ID:	35537

Save Setup To Header

Allows you to save new file header information details to the file.

Key Path:	Source, Modulation Setup, ARB, Header Utilities
Remote Command:	:SOURce:RADio:ARB:HEADer:SAVE
Example:	SOUR:RAD:ARB:HEAD:SAVE
Notes:	Attempting to save the header details via SCPI when no waveform was selected for playback will generate an error.
Initial S/W Revision:	A.05.00
Help Map ID:	35538

Query Waveform Unique ID (Remote Command Only)

Each Signal Studio waveform contains a unique waveform ID, which recorded in the header. This command allows you to query the unique waveform ID from the header. This is a SCPI only command.

Remote Command:	:MMEMory:HEADer:ID? "<file name>"
Example:	:MMEM:HEAD:ID? "test.wfm" (query the waveform already loaded into the ARB memory) :MMEM:HEAD:ID? "D:\NVARB\test.wfm" (query the waveform on the hard disk by absolute path) :MMEM:HEAD:ID? "NVWFM:test.wfm" (query the waveform on the hard disk by MSUS)
Notes:	SCPI query only. The queried waveform file can be in ARB memory, or on hard disk. If want to query ARB in ARB memory, then give out the file name directly. If want to query ARB on the hard disk, then absolute file path or MSUS should be given along with the file name. The valid MSUS is "NVWFM" which is mapped to D:\NVARB on hard disk. If the file cannot be found in ARB memory or on hard disk, an error is generated.and value -1 is returned
Initial S/W Revision:	A.09.00
Help Map ID:	0

Query Selected Waveform Header info (Remote Command Only)

This query provides a listing of the current selected ARB header info. If no ARB selected, then empty string is returned..

Remote Command:	:SOURce:RADio:ARB:HEADer:INFormation?
Example:	SOUR:RAD:ARB:HEAD:INF?
Notes:	<p>Query only</p> <p>After each colon of field title string, related header info string will be appended.</p> <p>The field title string in "Range" part cannot change, for Sequence Studio needs to accurately match those string character to know which header info field it is.</p> <p>Below are related abbreviation description:</p> <p>"DESC" - Description</p> <p>"SR" - Sample Rate</p> <p>"RTS" - Run Time Scaling</p> <p>"RMS" - Root Mean Square</p> <p>"M1P" - Marker 1 Polarity</p> <p>"M2P" - Marker 2 Polarity</p> <p>"M3P" - Marker 3 Polarity</p> <p>"M4P" - Marker 4 Polarity</p> <p>"ALCHR" - ALC Hold Routing</p> <p>"RFBR" - RF Blank Routing</p> <p>"FOFF" - Frequency Offset</p> <p>"AWGNST" - AWGN State</p> <p>"AWGNCN" - AWGN C/N Ratio</p> <p>"AWGNCBW" - AWGN Carrier Bandwidth</p> <p>"AWGNNBW" - AWGN Noise Bandwidth</p> <p>"AWGNCRMS" - AWGN Carrier RMS</p> <p>"ORP" - DAC Over Range Protection</p> <p>"UID" - Unique ID</p> <p>"LICSTS" - License Status</p>
Range:	"DESC:", "SR:", "RTS:", "RMS:", "M1P:", "M2P:", "M3P:", "M4P:", "ALCHR:", "RFBR:", "FOFF:", "AWGNST:", "AWGNCN:", "AWGNCBW:", "AWGNNBW:", "AWGNCRMS:", "ORP:", "UID:", "LICSTS"
Initial S/W Revision:	A.12.00
Help Map ID:	0

Common Measurement Functions 1

Bus Trigger Command (Remote Command Only)

Used to initiate an immediate trigger event if the trigger source is set to Bus.

Remote Command:	:SOURce:RADio:ARB:TRIGger:INITiate
Example:	SOUR:RAD:ARB:TRIG:INIT
Initial S/W Revision:	A.05.00
Help Map ID:	35691

AM

Allows access to the menu for configuring the Amplitude Modulation.

Key Path:	Source, Modulation Setup
Initial S/W Revision:	A.05.00
Help Map ID:	35539

AM

Enables or disables the amplitude modulation.

Turning AM on when another modulation format is already on results in the previous modulation format being turned off and the generation of an error.

Key Path:	Source, Modulation Setup, AM
Remote Command:	:SOURce:AM:STATe :SOURce:AM:STATe?
Example:	SOUR:AM:STAT OFF
Preset:	Off
Range:	On Off
Initial S/W Revision:	A.05.00
Help Map ID:	35540

AM Depth

Allows you to set the amplitude modulation depth in percent.

Key Path:	Source, Modulation Setup, AM
Remote Command:	:SOURce:AM[:DEPTh] [:LINear] :SOURce:AM[:DEPTh] [:LINear] ?
Example:	SOUR:AM 0.1
Preset:	0.1 %

Min:	0.1 %
Max:	95.0 %
Initial S/W Revision:	A.05.00
Help Map ID:	35541

AM Rate

Allows you to set the internal amplitude modulation rate.

Key Path:	Source, Modulation Setup, AM
Remote Command:	:SOURce:AM:INTernal:FREQuency :SOURce:AM:INTernal:FREQuency?
Example:	SOUR:AM:INT:FREQ 40.0 Hz
Preset:	400.0 Hz
Min:	10 Hz
Max:	40 kHz
Initial S/W Revision:	A.05.00
Help Map ID:	35542

FM

Allows access to the menu for configuring the frequency modulation.

Key Path:	Source, Modulation Setup
Initial S/W Revision:	A.05.00
Help Map ID:	35543

FM

Enables or disables the frequency modulation.

Turning FM on when another modulation format is already on results in the previous modulation format being turned off and the generation of an error.

Key Path:	Source, Modulation Setup, FM
Remote Command:	:SOURce:FM:STATe :SOURce:FM:STATe?
Example:	SOUR:FM:STAT OFF
Preset:	Off
Range:	On Off

Common Measurement Functions 1

Initial S/W Revision:	A.05.00
Help Map ID:	35544

FM Deviation

Allows you to set the frequency modulation deviation.

Key Path:	Source, Modulation Setup, FM
Remote Command:	:SOURce:FM[:DEVIation] :SOURce:FM[:DEVIation]?
Example:	SOUR:FM 1.00 kHz
Preset:	1.00 Hz
Min:	1.00 Hz
Max:	100.00 kHz
Initial S/W Revision:	A.05.00
Help Map ID:	35545

FM Rate

Allows you to set the internal frequency modulation rate.

Key Path:	Source, Modulation Setup, FM
Remote Command:	:SOURce:FM:INTernal:FREQuency :SOURce:FM:INTernal:FREQuency?
Example:	SOUR:FM:INT:FREQ 40.0 Hz
Preset:	400.0 Hz
Min:	10 Hz
Max:	40 kHz
Initial S/W Revision:	A.05.00
Help Map ID:	35546

PM

Allows access to the menu for configuring the phase modulation.

Key Path:	Source, Modulation Setup
Initial S/W Revision:	A.05.00
Help Map ID:	35547

PM

Enables or disables the phase modulation.

Turning PM on when another modulation format is already on results in the previous modulation format being turned off and the generation of an error.

Key Path:	Source, Modulation Setup, PM
Remote Command:	:SOURce:PM:STATe :SOURce:PM:STATe?
Example:	SOUR:PM:STAT OFF
Preset:	Off
Range:	On Off
Initial S/W Revision:	A.05.00
Help Map ID:	35548

PM Deviation

Allows you to set the phase modulation deviation.

Key Path:	Source, Modulation Setup, PM
Remote Command:	:SOURce:PM[:DEVIation] :SOURce:PM[:DEVIation]?
Example:	SOUR:PM 1.00 rad
Preset:	0.1 rad
Min:	0.1 rad
Max:	20.0 rad
Initial S/W Revision:	A.05.00
Help Map ID:	35549

PM Rate

Allows you to set the internal phase modulation rate.

Key Path:	Source, Modulation Setup, PM
Remote Command:	:SOURce:PM:INTernal:FREQuency :SOURce:PM:INTernal:FREQuency?
Example:	SOUR:PM:INT:FREQ 40.0 Hz
Preset:	400.0 Hz
Min:	10 Hz

Common Measurement Functions 1

Max:	40 kHz
Initial S/W Revision:	A.05.00
Help Map ID:	35550

Multiport Adapter Output Port Amplitude Correction Configuration Validation (Remote Command Only)

This command is used to validate MPA TX port amplitude correction for Source MXG Mode.

Key Path:	Remote Command Only
Remote Command:	:SOURce:RADio:MPADapter:CORRection:ERRor?
Example:	SOUR:RAD:MPAD:CORR:ERR?
Note	<p>Query Only SCPI</p> <p>Remote command only</p> <p>If detected invalid configuration, popup error message</p> <p>"-221 Settings conflict; MPA TX port<n> amplitude correction value <n>dB is out of range. The valid range is <n> ~ <n>dB"</p> <p>Or</p> <p>"-221 Settings conflict; MPA TX port<n> amplitude correction delta exceeds <n>dB between port<n> and port<n>"</p> <p>to report the first detected conflict.</p>
Range:	"No error" Error info of the first found conflic
Initial S/W Revision:	A.12.00
Help Map ID:	0

List Sequencer

Allows you access to the sub-menus for configuring the list sequencer.

List sequences allows you to enter frequencies and amplitudes at unequal intervals in nonlinear ascending, descending or random order. Each step within the list can also include its own waveform file for playback, step duration, trigger event and trigger output.

The complexities involved in configuring the list sequencer do not lend itself to manual configuration; hence the manual configuration for this feature is limited. For easier configuration of the list sequencer, it is recommended that you use either SCPI or load a tab delimited file containing the setup parameters in a tabular form. The details of the SCPI for configuring the list sequencer can be found in [“Step Configuration \(Remote Command Only\)” on page 1620](#).

Once the List Sequencer has been configured using the front panel, SCPI, or loading in a tab delimited file, the sequence must be initiated using the front panel Initiate Sequence key or the corresponding SCPI

command.

Key Path:	Source
Initial S/W Revision:	A.05.00
Help Map ID:	35551

Sequencer

Allows you to set the state of the list sequencer. When the list sequencer is on, the source is outputting the sequence defined by the sequencer. When the list sequencer is off, the source outputs a single waveform segment or sequence (independent mode) at a single frequency and amplitude.

Key Path:	Source, List Sequencer
Remote Command:	:SOURce:LIST[:STATe] ON OFF 1 0 :SOURce:LIST[:STATe] ?
Example:	SOUR:LIST OFF
Notes:	When the sequencer is set to ON, the list sequencer controls the output of the source.
Couplings:	When in Sequence Analyzer mode and the list sequencer state is Off, Include Source is forced to No, and the Include Source key is grayed out. When in Sequence Analyzer mode and the list sequencer state is On, Include Source is available to set. And, an ARB memory related operation, like load or delete will be rejected.
Preset:	Off
Range:	On Off
Initial S/W Revision:	A.05.00
Help Map ID:	35552

Initiate Sequence

Pressing this key arms the sequence for single execution. Once the sequence is armed the source begins the sequence as soon as the trigger is received. If the trigger is set to Free Run, the sequence starts immediately.

Key Path:	Source, List Sequencer
Remote Command:	:SOURce:LIST:TRIGger[:IMMediate]
Example:	SOUR:LIST:TRIG

Common Measurement Functions 1

Notes:	<p>When in Sequence Analyzer mode and Include Source is Yes, the Initiate list sequencer operation is rejected, and the key is grayed out, since source list sequence request is sent to physics via Parallel batch by sequence analyzer.</p> <p>If the file needed by the sequencer is not already in ARB memory, the sequence cannot be initiated and an error will be generated.</p> <p>There is a blocking SCPI query which can be used to query if source list sequence being initiated successfully or not. (see “Query List Sequence Initiation Armed Status (Remote Command Only)” on page 1630 Query Source List Sequence Armed Status)</p>
Dependencies:	Under the Sequence Analyzer Mode, if Meas Setup->Include Source is set to YES, Source->List Sequencer->Initiate Sequence is disabled.
Initial S/W Revision:	A.05.00
Help Map ID:	35554

Remote Software Trigger (Remote command Only)

During execution of a list sequence, the sequence will halt and wait at any step that has Step Trigger set to “Bus”. Sending this command will trigger the step and continue the sequence.

Remote Command:	:SOURce:LIST:TRIGger:INITiate[:IMMediate]
Example:	SOUR:LIST:TRIG:INIT
Initial S/W Revision:	A.05.00
Help Map ID:	35679

List Sequencer Setup

Allows you access to the list sequencer setup menus.

Key Path:	Source, List Sequencer
Help Map ID:	35555

Number of Steps

Allows you to specify the number of steps within the list sequence.

Key Path:	Source, List Sequencer, List Sequencer Setup
Remote Command:	:SOURce:LIST:NUMBer:STEPs <integer> :SOURce:LIST:NUMBer:STEPs?
Example:	SOUR:LIST:NUMB:STEP 1

Notes:	Increasing the number of steps creates additional steps at the end of the list, with all the settings within the steps set to their default values. Decreasing the number of steps removes steps from the end of the list. The settings within the removed steps are not reset. This means that increasing the number of steps again would allow you to retrieve these steps.
Dependencies:	The Step Count parameter is increased or decreased when you insert or delete a point from within the GUI interface to the sequencer.
Preset:	1
Min:	1
Max:	1000
Initial S/W Revision:	A.05.00
Help Map ID:	35556

Current Step

Allows you to select the step number you wish to view or edit.

Key Path:	Source, List Sequencer, List Sequencer Setup
Notes:	No remote command, front panel only.
Preset:	1
Min:	1
Max:	Step Count
Initial S/W Revision:	A.05.00
Help Map ID:	35557

Insert Step Before

Allows you to insert a new step, containing default values, before the currently selected step. Inserting a step will automatically increase the Step Count parameter by 1. If sequence already reaches upper limit of 1000 steps, then insert more step will be rejected and popup error -221, "Setting Conflict; Cannot insert more steps, maximum number of steps reached"

Key Path:	Source, List Sequencer, List Sequencer Setup
Notes:	No remote command, front panel only. If the list already contains the maximum limit of 1000 steps, no operation will be made after pressing this key.
Initial S/W Revision:	A.05.00
Help Map ID:	35558

Delete Step

Allows you to delete the current step. Deleting a step will automatically decrease the Step Count parameter by 1. If

Common Measurement Functions 1

sequence only has one step left, delete step will be rejected and popup error –221, “Setting conflict; Cannot delete current step, minimum number of steps reached”

Key Path:	Source, List Sequencer, List Sequencer Setup
Notes:	No remote command, Front Panel key only. If the list already contains the minimum limit of 1 step, no operation will be made after pressing this key
Initial S/W Revision:	A.05.00
Help Map ID:	35559

Clear List

Allows you to clear the list. Clearing the list sets the number of steps to the default value of 1 and sets the parameters for the only step to their default values.

Key Path:	Source, List Sequencer, List Sequencer Setup
Initial S/W Revision:	A.05.00
Help Map ID:	35560

Step Trigger

Allows access to the sub-menu for selecting the trigger input for the current step.

Key Path:	Source, List Sequencer, List Sequencer Setup
Remote Command:	:SOURce:LIST:STEP [1] 2 3...1000:SETup:INPut:TRIGger IMMediate INTernal EXTernal2 KEY BUS :SOURce:LIST:STEP [1] 2 3...1000:SETup:INPut:TRIGger?
Example:	SOUR:LIST:STEP2:SET:INP:TRIG BUS SOUR:LIST:STEP2:SET:INP:TRIG?
Notes:	SCPI is supported after A.09.40
Preset:	Free Run
Range:	Free Run Internal Manual (Trigger Key) Bus External 2
Initial S/W Revision:	A.05.00
Help Map ID:	35561

Free Run

Sets the trigger input for the current step to Free Run.

Key Path:	Source, List Sequencer, List Sequencer Setup, Step Trigger
Example:	SOUR:LIST:STEP2:SET:INP:TRIG IMM

Notes:	SCPI is supported after A.09.40
Initial S/W Revision:	A.05.00
Help Map ID:	35562

Internal

Sets the trigger input for the current step to Internal.

Key Path:	Source, List Sequencer, List Sequencer Setup, Step Trigger
Example:	SOUR:LIST:STEP2:SET:INP:TRIG INT
Notes:	SCPI is supported after A.09.40
Initial S/W Revision:	A.05.00
Help Map ID:	35563

Manual (Trigger Key)

Sets the trigger input for the current step to Manual (Trigger Key). Any step in the sequence set to Manual will cause the sequence execution to stop until the manual trigger key is pressed. Sending the Bus Trigger SCPI command will have no effect. At any point in the sequence where the list sequencer is paused waiting for a software trigger, a pop up dialog is displayed until the trigger event occurs.

Key Path:	Source, List Sequencer, List Sequencer Setup, Step Trigger
Example:	SOUR:LIST:STEP2:SET:INP:TRIG KEY
Notes:	SCPI is supported after A.09.40
Initial S/W Revision:	A.05.00
Help Map ID:	35680

Bus

Sets the trigger input for the current step to Bus. Any step in the sequence set to Bus will cause the sequence execution to stop until the Bus Trigger SCPI command is sent. Pressing the manual trigger key has no effect. At any point in the sequence where the list sequencer is paused waiting for a software trigger, a pop up dialog is displayed until the trigger event occurs.

Key Path:	Source, List Sequencer, List Sequencer Setup, Step Trigger
Example:	SOUR:LIST:STEP2:SET:INP:TRIG BUS
Notes:	SCPI is supported after A.09.40
Initial S/W Revision:	A.05.00
Help Map ID:	35681

Common Measurement Functions 1

External 2

Sets the trigger input for the current step to External 2.

Key Path:	Source, List Sequencer, List Sequencer Setup, Step Trigger
Example:	SOUR:LIST:STEP2:SET:INP:TRIG EXT2
Notes:	SCPI is supported after A.09.40
Initial S/W Revision:	A.05.00
Help Map ID:	35564

Transition Time

Allows you to specify the transition time for the current step.

The transition time is the amount of time allowed for the source to settle at the current frequency or amplitude value.

Transition Time should not be taken as additional time before or inside the Step Duration. You can set a value for the settling time to allow the source output frequency or amplitude to become stable. Make sure that during this period of time, you do not use the source output signal.

The following table lists recommended values for appropriate settling times to allow for changes within the source.

Value Changed	Recommended Transition Time
Frequency	Switching within same frequency band: 300 μ s Switching across frequency bands: 1 ms The band ranges are: Frequency Band 1: -0.08 GHz to 0.6075 GHz Frequency Band 2: 0.5075 GHz to 2.1775 GHz Frequency Band 3: 2.0775 GHz to 3.6 GHz
Amplitude	500 μ s

If the Transition Time value is shorter than the time necessary for the hardware to settle and a List Sequence is initiated, a **warning** is generated.

If the Transition Time value is longer than the Step Duration, an error is generated when initiating a source list sequence. For source list sequence, transition time is included in the step duration length. If the Transition Time value is longer than the Step Duration Time, the real step duration length is extended to equal the transition time and cause a timing shift.

Key Path:	Source, List Sequencer, List Sequencer Setup
Remote Command:	:SOURce:LIST:STEP [1] 2 3...1000:SETup:TRANsition:TIME <time> :SOURce:LIST:STEP [1] 2 3...1000:SETup:TRANsition:TIME?
Example:	SOUR:LIST:STEP2:SET:TRAN:TIME 1ms SOUR:LIST:STEP2:SET:TRAN:TIME?

Notes:	SCPI is supported after A.09.40
Preset:	1.0 ms
Min:	0.0 ms
Max:	4.0 ks
Initial S/W Revision:	A.05.00
Help Map ID:	35571

Radio Setup

Allows you access to the sub-menus for setting up the radio standard, band, and radio band link direction for the current step.

Key Path:	Source, List Sequencer, List Sequencer Setup
Notes:	No remote command, front panel only.
Initial S/W Revision:	A.05.00
Help Map ID:	35572

Radio Standard

Allows access to the sub-menus for selecting the radio standard and the associated radio band for use in the current step.

Key Path:	Source, List Sequencer, List Sequencer Setup, Radio Setup
Remote Command:	:SOURce:LIST:STEP [1] 2 3...1000:SETup:RADio: BAND NONE PGSM EGSM RGSM DCS1800 PCS1900 TGSM810 GSM450 GSM4 80 GSM700 GSM850 BANDI BANDII BANDIII BANDIV BANDV BAND VI BANDVII BANDVIII BANDIX BANDX BANDXI BANDXII BANDXII I BANDXIV USCELL USPCS JAPAN KOREAN NMT IMT2K UPPER SEC OND PAMR400 PAMR800 IMTEXT PCS1DOT9G AWS US2DOT5G PUBLI C LOWER NONE BAND1 BAND2 BAND3 BAND4 BAND5 BAND6 BAND7 BAND8 BAND10 BAND11 BAND12 BAND13 BAND14 BAND17 BAND18 BAND19 BAND20 BAND21 BAND24 BAND25 BAND26 BAND33 BAND34 BAND35 BAND36 BAND37 BAND38 BAND39 BAND40 BAND41 BAND4 2 BAND43 BANDA BANDB BANDC BANDD BANDE BANDF :SOURce:LIST:STEP [1] 2 3...1000:SETup: RADio: BAND?
Example:	SOUR:LIST:STEP2:SET:RAD: BAND PGSM SOUR:LIST:STEP2:SET:RAD: BAND?
Notes:	SCPI is supported after A.09.40
Initial S/W Revision:	A.05.00
Help Map ID:	35573

Common Measurement Functions 1

None

Selects no radio standard for use on the current step.

Key Path:	Source, List Sequencer, List Sequencer Setup, Radio Setup, Radio Standard
Example:	SOUR:LIST:STEP2:SET:RAD:BAND NONE
Notes:	SCPI is supported after A.09.40
Initial S/W Revision:	A.05.00
Help Map ID:	35574

GSM/EDGE

Pressing this key once selects GSM/EDGE as the radio standard and the current GSM/EDGE band as the active channel band. Pressing this key again allows access to the sub-menus for selecting a different GSM/EDGE band.

Key Path:	Source, List Sequencer, List Sequencer Setup, Radio Setup, Radio Standard
Initial S/W Revision:	A.05.00
Help Map ID:	35575

P-GSM

Selects P-GSM as the band for the current step.

Key Path:	Source, List Sequencer, List Sequencer Setup, Radio Setup, Radio Standard, GSM/EDGE
Initial S/W Revision:	A.05.00
Help Map ID:	35576

E-GSM

Selects E-GSM as the band for the current step.

Key Path:	Source, List Sequencer, List Sequencer Setup, Radio Setup, Radio Standard, GSM/EDGE
Initial S/W Revision:	A.05.00
Help Map ID:	35577

R-GSM

Selects R-GSM as the band for the current step.

Key Path:	Source, List Sequencer, List Sequencer Setup, Radio Setup, Radio Standard, GSM/EDGE
Initial S/W Revision:	A.05.00

Help Map ID:	35578
--------------	-------

DCS 1800

Selects DCS 1800 as the band for the current step.

Key Path:	Source, List Sequencer, List Sequencer Setup, Radio Setup, Radio Standard, GSM/EDGE
Initial S/W Revision:	A.05.00
Help Map ID:	35579

PCS 1900

Selects PCS 1900 as the band for the current step.

Key Path:	Source, List Sequencer, List Sequencer Setup, Radio Setup, Radio Standard, GSM/EDGE
Initial S/W Revision:	A.05.00
Help Map ID:	35580

GSM 450

Selects GSM 450 as the band for the current step.

Key Path:	Source, List Sequencer, List Sequencer Setup, Radio Setup, Radio Standard, GSM/EDGE
Initial S/W Revision:	A.05.00
Help Map ID:	35582

GSM 480

Selects GSM 480 as the band for the current step.

Key Path:	Source, List Sequencer, List Sequencer Setup, Radio Setup, Radio Standard, GSM/EDGE
Initial S/W Revision:	A.05.00
Help Map ID:	35583

GSM 850

Selects GSM 850 as the band for the current step.

Key Path:	Source, List Sequencer, List Sequencer Setup, Radio Setup, Radio Standard, GSM/EDGE
Initial S/W Revision:	A.05.00
Help Map ID:	35585

Common Measurement Functions 1

GSM 700

Selects GSM 700 as the band for the current step.

Key Path:	Source, List Sequencer, List Sequencer Setup, Radio Setup, Radio Standard, GSM/EDGE
Initial S/W Revision:	A.05.00
Help Map ID:	35584

T-GSM 810

Selects T-GSM 810 as the band for the current step.

Key Path:	Source, List Sequencer, List Sequencer Setup, Radio Setup, Radio Standard, GSM/EDGE
Initial S/W Revision:	A.05.00
Help Map ID:	35581

WCDMA

Pressing this key once selects WCDMA as the radio standard and the current WCDMA band as the active channel band. Pressing this key again allows access to the sub-menus for selecting a different WCDMA band.

Key Path:	Source, List Sequencer, List Sequencer Setup, Radio Setup, Radio Standard
Initial S/W Revision:	A.05.00
Help Map ID:	35586

Band I

Selects Band I as the band for the current step.

Key Path:	Source, List Sequencer, List Sequencer Setup, Radio Setup, Radio Standard, WCDMA
Initial S/W Revision:	A.05.00
Help Map ID:	35587

Band II

Selects Band II as the band for the current step.

Key Path:	Source, List Sequencer, List Sequencer Setup, Radio Setup, Radio Standard, WCDMA
Initial S/W Revision:	A.05.00
Help Map ID:	35588

Band III

Selects Band III as the band for the current step.

Key Path:	Source, List Sequencer, List Sequencer Setup, Radio Setup, Radio Standard, WCDMA
Initial S/W Revision:	A.05.00
Help Map ID:	35589

Band IV

Selects Band IV as the band for the current step.

Key Path:	Source, List Sequencer, List Sequencer Setup, Radio Setup, Radio Standard, WCDMA
Initial S/W Revision:	A.05.00
Help Map ID:	35590

Band V

Selects Band V as the band for the current step.

Key Path:	Source, List Sequencer, List Sequencer Setup, Radio Setup, Radio Standard, WCDMA
Initial S/W Revision:	A.05.00
Help Map ID:	35591

Band VI

Selects Band VI as the band for the current step.

Key Path:	Source, List Sequencer, List Sequencer Setup, Radio Setup, Radio Standard, WCDMA
Initial S/W Revision:	A.05.00
Help Map ID:	35592

Band VII

Selects Band VII as the band for the current step.

Key Path:	Source, List Sequencer, List Sequencer Setup, Radio Setup, Radio Standard, WCDMA
Initial S/W Revision:	A.05.00
Help Map ID:	35593

Common Measurement Functions 1

Band VIII

Selects Band VIII as the band for the current step.

Key Path:	Source, List Sequencer, List Sequencer Setup, Radio Setup, Radio Standard, WCDMA
Initial S/W Revision:	A.05.00
Help Map ID:	35594

Band IX

Selects Band IX as the band for the current step.

Key Path:	Source, List Sequencer, List Sequencer Setup, Radio Setup, Radio Standard, WCDMA
Initial S/W Revision:	A.05.00
Help Map ID:	35595

Band X

Selects Band X as the band for the current step.

Key Path:	Source, List Sequencer, List Sequencer Setup, Radio Setup, Radio Standard, WCDMA
Initial S/W Revision:	A.05.00
Help Map ID:	35596

Band XI

Selects Band XI as the band for the current step.

Key Path:	Source, List Sequencer, List Sequencer Setup, Radio Setup, Radio Standard, WCDMA
Initial S/W Revision:	A.05.00
Help Map ID:	35597

Band XII

Selects Band XII as the band for the current step.

Key Path:	Source, List Sequencer, List Sequencer Setup, Radio Setup, Radio Standard, WCDMA
Initial S/W Revision:	A.05.00
Help Map ID:	35598

Band XIII

Selects Band XIII as the band for the current step.

Key Path:	Source, List Sequencer, List Sequencer Setup, Radio Setup, Radio Standard, WCDMA
Initial S/W Revision:	A.05.00
Help Map ID:	35599

Band XIV

Selects Band XIV as the band for the current step.

Key Path:	Source, List Sequencer, List Sequencer Setup, Radio Setup, Radio Standard, WCDMA
Initial S/W Revision:	A.05.00
Help Map ID:	35600

CDMA 2000 / 1xEVDO

Pressing this key once selects CDMA 2000/1xEVDO as the radio standard and the current CDMA 2000/1xEVDO band as the active channel band. Pressing this key again allows access to the sub-menus for selecting a different CDMA 2000/1xEVDO band.

Key Path:	Source, List Sequencer, List Sequencer Setup, Radio Setup, Radio Standard
Initial S/W Revision:	A.05.00
Help Map ID:	35601

US CELL

Selects US Cell as the band for the current step.

Key Path:	Source, List Sequencer, List Sequencer Setup, Radio Setup, Radio Standard, CDMA 2000 / 1xEVDO
Initial S/W Revision:	A.05.00
Help Map ID:	35602

US PCS

Selects US PCS as the band for the current step.

Key Path:	Source, List Sequencer, List Sequencer Setup, Radio Setup, Radio Standard, CDMA 2000 / 1xEVDO
Initial S/W Revision:	A.05.00
Help Map ID:	35603

Common Measurement Functions 1

Japan Cell

Selects Japan Cell as the band for the current step.

Key Path:	Source, List Sequencer, List Sequencer Setup, Radio Setup, Radio Standard, CDMA 2000 / 1xEVDO
Initial S/W Revision:	A.05.00
Help Map ID:	35604

Korean PCS

Selects Korean PCS as the band for the current step.

Key Path:	Source, List Sequencer, List Sequencer Setup, Radio Setup, Radio Standard, CDMA 2000 / 1xEVDO
Initial S/W Revision:	A.05.00
Help Map ID:	35605

NMT 450

Selects NMT 450 as the band for the current step.

Key Path:	Source, List Sequencer, List Sequencer Setup, Radio Setup, Radio Standard, CDMA 2000 / 1xEVDO
Initial S/W Revision:	A.05.00
Help Map ID:	35606

IMT 2000

Selects IMT 2000 as the band for the current step.

Key Path:	Source, List Sequencer, List Sequencer Setup, Radio Setup, Radio Standard, CDMA 2000 / 1xEVDO
Initial S/W Revision:	A.05.00
Help Map ID:	35607

Upper 700

Selects Upper 700 as the band for the current step.

Key Path:	Source, List Sequencer, List Sequencer Setup, Radio Setup, Radio Standard, CDMA 2000 / 1xEVDO
Initial S/W Revision:	A.05.00
Help Map ID:	35608

Secondary 800

Selects Secondary 800 as the band for the current step.

Key Path:	Source, List Sequencer, List Sequencer Setup, Radio Setup, Radio Standard, CDMA 2000 / 1xEVDO
Initial S/W Revision:	A.05.00
Help Map ID:	35609

400 Euro PAMR

Selects 400 Euro PAMR as the band for the current step.

Key Path:	Source, List Sequencer, List Sequencer Setup, Radio Setup, Radio Standard, CDMA 2000 / 1xEVDO
Initial S/W Revision:	A.05.00
Help Map ID:	35610

800 PAMR

Selects 800 PAMR as the band for the current step.

Key Path:	Source, List Sequencer, List Sequencer Setup, Radio Setup, Radio Standard, CDMA 2000 / 1xEVDO
Initial S/W Revision:	A.05.00
Help Map ID:	35611

2.5GHz IMT EXT

Selects 2.5 GHz IMT EXT as the band for the current step.

Key Path:	Source, List Sequencer, List Sequencer Setup, Radio Setup, Radio Standard, CDMA 2000 / 1xEVDO
Initial S/W Revision:	A.05.00
Help Map ID:	35612

US PCS 1.9GHz

Selects US PCS 1.9 GHz as the band for the current step.

Key Path:	Source, List Sequencer, List Sequencer Setup, Radio Setup, Radio Standard, CDMA 2000 / 1xEVDO
Initial S/W Revision:	A.05.00
Help Map ID:	35613

Common Measurement Functions 1

AWS

Selects AWS as the band for the current step.

Key Path:	Source, List Sequencer, List Sequencer Setup, Radio Setup, Radio Standard, CDMA 2000 / 1xEVDO
Initial S/W Revision:	A.05.00
Help Map ID:	35614

US 2.5GHz

Selects US 2.5 GHz as the band for the current step.

Key Path:	Source, List Sequencer, List Sequencer Setup, Radio Setup, Radio Standard, CDMA 2000 / 1xEVDO
Initial S/W Revision:	A.05.00
Help Map ID:	35615

700 Public Safety

Selects 700 Public Safety as the band for the current step.

Key Path:	Source, List Sequencer, List Sequencer Setup, Radio Setup, Radio Standard, CDMA 2000 / 1xEVDO
Initial S/W Revision:	A.05.00
Help Map ID:	35616

C2K Lower 700

Selects C2K Lower 700 as the band for the current step.

Key Path:	Source, List Sequencer, List Sequencer Setup, Radio Setup, Radio Standard, CDMA 2000 / 1xEVDO
Initial S/W Revision:	A.05.00
Help Map ID:	35617

LTE

Pressing this key once selects LTE FDD as the radio standard and the current LTE FDD band as the active channel band. Pressing this key again allows access to the sub-menus for selecting a different LTE FDD band.

Key Path:	Source, List Sequencer, List Sequencer Setup, Radio Setup, Radio Standard
Initial S/W Revision:	A.09.50
Help Map ID:	35723

BAND 1

Selects BAND 1 as the band for the current step.

Key Path:	Source, List Sequencer, List Sequencer Setup, Radio Setup, Radio Standard, LTE
Initial S/W Revision:	A.09.50
Help Map ID:	35724

BAND 2

Selects BAND 2 as the band for the current step.

Key Path:	Source, List Sequencer, List Sequencer Setup, Radio Setup, Radio Standard, LTE
Initial S/W Revision:	A.09.50
Help Map ID:	35725

BAND 3

Selects BAND 3 as the band for the current step.

Key Path:	Source, List Sequencer, List Sequencer Setup, Radio Setup, Radio Standard, LTE
Initial S/W Revision:	A.09.50
Help Map ID:	35726

BAND 4

Selects BAND 4 as the band for the current step.

Key Path:	Source, List Sequencer, List Sequencer Setup, Radio Setup, Radio Standard, LTE
Initial S/W Revision:	A.09.50
Help Map ID:	35727

BAND 5

Selects BAND 5 as the band for the current step.

Key Path:	Source, List Sequencer, List Sequencer Setup, Radio Setup, Radio Standard, LTE
Initial S/W Revision:	A.09.50
Help Map ID:	35728

Common Measurement Functions 1

BAND 6

Selects BAND 6 as the band for the current step.

Key Path:	Source, List Sequencer, List Sequencer Setup, Radio Setup, Radio Standard, LTE
Initial S/W Revision:	A.09.50
Help Map ID:	35729

BAND 7

Selects BAND 7 as the band for the current step.

Key Path:	Source, List Sequencer, List Sequencer Setup, Radio Setup, Radio Standard, LTE
Initial S/W Revision:	A.09.50
Help Map ID:	35730

BAND 8

Selects BAND 8 as the band for the current step.

Key Path:	Source, List Sequencer, List Sequencer Setup, Radio Setup, Radio Standard, LTE
Initial S/W Revision:	A.09.50
Help Map ID:	35731

BAND 9

Selects BAND 9 as the band for the current step.

Key Path:	Source, List Sequencer, List Sequencer Setup, Radio Setup, Radio Standard, LTE
Initial S/W Revision:	A.09.50
Help Map ID:	35732

BAND 10

Selects BAND 10 as the band for the current step.

Key Path:	Source, List Sequencer, List Sequencer Setup, Radio Setup, Radio Standard, LTE
Initial S/W Revision:	A.09.50
Help Map ID:	35733

BAND 11

Selects BAND 11 as the band for the current step.

Key Path:	Source, List Sequencer, List Sequencer Setup, Radio Setup, Radio Standard, LTE
Initial S/W Revision:	A.09.50
Help Map ID:	35734

BAND 12

Selects BAND 12 as the band for the current step.

Key Path:	Source, List Sequencer, List Sequencer Setup, Radio Setup, Radio Standard, LTE
Initial S/W Revision:	A.09.50
Help Map ID:	35735

BAND 13

Selects BAND 13 as the band for the current step.

Key Path:	Source, List Sequencer, List Sequencer Setup, Radio Setup, Radio Standard, LTE
Initial S/W Revision:	A.09.50
Help Map ID:	35736

BAND 14

Selects BAND 14 as the band for the current step.

Key Path:	Source, List Sequencer, List Sequencer Setup, Radio Setup, Radio Standard, LTE
Initial S/W Revision:	A.09.50
Help Map ID:	35737

BAND 17

Selects BAND 17 as the band for the current step.

Key Path:	Source, List Sequencer, List Sequencer Setup, Radio Setup, Radio Standard, LTE
Initial S/W Revision:	A.09.50
Help Map ID:	35738

Common Measurement Functions 1

BAND 18

Selects BAND 18 as the band for the current step.

Key Path:	Source, List Sequencer, List Sequencer Setup, Radio Setup, Radio Standard, LTE
Initial S/W Revision:	A.09.50
Help Map ID:	35739

BAND 19

Selects BAND 19 as the band for the current step.

Key Path:	Source, List Sequencer, List Sequencer Setup, Radio Setup, Radio Standard, LTE
Initial S/W Revision:	A.09.50
Help Map ID:	35740

BAND 20

Selects BAND 20 as the band for the current step.

Key Path:	Source, List Sequencer, List Sequencer Setup, Radio Setup, Radio Standard, LTE
Initial S/W Revision:	A.09.50
Help Map ID:	35741

BAND 21

Selects BAND 21 as the band for the current step.

Key Path:	Source, List Sequencer, List Sequencer Setup, Radio Setup, Radio Standard, LTE
Initial S/W Revision:	A.09.50
Help Map ID:	35742

BAND 24

Selects BAND 24 as the band for the current step.

Key Path:	Source, List Sequencer, List Sequencer Setup, Radio Setup, Radio Standard, LTE
Initial S/W Revision:	A.09.50
Help Map ID:	35743

BAND 25

Selects BAND 25 as the band for the current step.

Key Path:	Source, List Sequencer, List Sequencer Setup, Radio Setup, Radio Standard, LTE
Initial S/W Revision:	A.09.50
Help Map ID:	35744

BAND 26

Selects BAND 26 as the band for the current step.

Key Path:	Source, List Sequencer, List Sequencer Setup, Radio Setup, Radio Standard, LTE
Initial S/W Revision:	A.12.53
Help Map ID:	35805

LTE TDD

Pressing this key once selects LTE TDD as the radio standard and the current LTE TDD band as the active channel band. Pressing this key again allows access to the sub-menus for selecting a different LTE TDD band

Key Path:	Source, List Sequencer, List Sequencer Setup, Radio Setup, Radio Standard
Initial S/W Revision:	A.11.50
Help Map ID:	35785

BAND 33

Selects BAND 33 as the band for the current step.

Key Path:	Source, List Sequencer, List Sequencer Setup, Radio Setup, Radio Standard, LTE TDD
Initial S/W Revision:	A.11.50
Help Map ID:	35786

BAND 34

Selects BAND 34 as the band for the current step.

Key Path:	Source, List Sequencer, List Sequencer Setup, Radio Setup, Radio Standard, LTE TDD
Initial S/W Revision:	A.11.50
Help Map ID:	35787

Common Measurement Functions 1

BAND 35

Selects BAND 35 as the band for the current step.

Key Path:	Source, List Sequencer, List Sequencer Setup, Radio Setup, Radio Standard, LTE TDD
Initial S/W Revision:	A.11.50
Help Map ID:	35788

BAND 36

Selects BAND 36 as the band for the current step.

Key Path:	Source, List Sequencer, List Sequencer Setup, Radio Setup, Radio Standard, LTE TDD
Initial S/W Revision:	A.11.50
Help Map ID:	35789

BAND 37

Selects BAND 37 as the band for the current step.

Key Path:	Source, List Sequencer, List Sequencer Setup, Radio Setup, Radio Standard, LTE TDD
Initial S/W Revision:	A.11.50
Help Map ID:	35790

BAND 38

Selects BAND 38 as the band for the current step.

Key Path:	Source, List Sequencer, List Sequencer Setup, Radio Setup, Radio Standard, LTE TDD
Initial S/W Revision:	A.11.50
Help Map ID:	35791

BAND 39

Selects BAND 39 as the band for the current step.

Key Path:	Source, List Sequencer, List Sequencer Setup, Radio Setup, Radio Standard, LTE TDD
Initial S/W Revision:	A.11.50
Help Map ID:	35792

BAND 40

Selects BAND 40 as the band for the current step.

Key Path:	Source, List Sequencer, List Sequencer Setup, Radio Setup, Radio Standard, LTE TDD
Initial S/W Revision:	A.11.50
Help Map ID:	35793

BAND 41

Selects BAND 41 as the band for the current step.

Key Path:	Source, List Sequencer, List Sequencer Setup, Radio Setup, Radio Standard, LTE TDD
Initial S/W Revision:	A.11.50
Help Map ID:	35794

BAND 42

Selects BAND 42 as the band for the current step.

Key Path:	Source, List Sequencer, List Sequencer Setup, Radio Setup, Radio Standard, LTE TDD
Initial S/W Revision:	A.11.50
Help Map ID:	35795

BAND 43

Selects BAND 43 as the band for the current step.

Key Path:	Source, List Sequencer, List Sequencer Setup, Radio Setup, Radio Standard, LTE TDD
Initial S/W Revision:	A.11.50
Help Map ID:	35796

TDSCDMA

Pressing this key once selects TDSCDMA as the radio standard and the current TDSCDMA band as the active channel band. Pressing this key again allows access to the sub-menus for selecting a different TDSCDMA band

Key Path:	Source, List Sequencer, List Sequencer Setup, Radio Setup, Radio Standard
Initial S/W Revision:	A.11.50
Help Map ID:	35797

Common Measurement Functions 1

BAND A

Selects BAND A as the band for the current step.

Key Path:	Source, List Sequencer, List Sequencer Setup, Radio Setup, Radio Standard, TDSCDMA
Initial S/W Revision:	A.11.50
Help Map ID:	35798

BAND B

Selects BAND B as the band for the current step.

Key Path:	Source, List Sequencer, List Sequencer Setup, Radio Setup, Radio Standard, TDSCDMA
Initial S/W Revision:	A.11.50
Help Map ID:	35799

BAND C

Selects BAND C as the band for the current step.

Key Path:	Source, List Sequencer, List Sequencer Setup, Radio Setup, Radio Standard, TDSCDMA
Initial S/W Revision:	A.11.50
Help Map ID:	35800

BAND D

Selects BAND D as the band for the current step.

Key Path:	Source, List Sequencer, List Sequencer Setup, Radio Setup, Radio Standard, TDSCDMA
Initial S/W Revision:	A.11.50
Help Map ID:	35801

BAND E

Selects BAND E as the band for the current step.

Key Path:	Source, List Sequencer, List Sequencer Setup, Radio Setup, Radio Standard, TDSCDMA
Initial S/W Revision:	A.11.50
Help Map ID:	35802

BAND F

Selects BAND F as the band for the current step.

Key Path:	Source, List Sequencer, List Sequencer Setup, Radio Setup, Radio Standard, TDSCDMA
Initial S/W Revision:	A.11.50
Help Map ID:	35803

Radio Band Link

Allows you to specify the radio band link direction for the steps within the list sequence. The link is used in conjunction with the channel band and channel number to determine the output frequency.

When set to “Uplink”, the source will calculate the uplink frequency according to an uplink formula together with selected channel band and channel number. When set to “Downlink”, the source will calculate the downlink frequency according to a downlink formula together with selected channel band and channel number.

Key Path:	Source, List Sequencer, List Sequencer Setup, Radio Setup
Remote Command:	:SOURCE:LIST:STEP [1] 2 3...1000:SETup:RADio:BAND:LINK DOWN UP :SOURCE:LIST:STEP [1] 2 3...1000:SETup:RADio:BAND:LINK?
Example:	SOUR:LIST:STEP2:SET:RAD:BAND:LINK UP SOUR:LIST:STEP2:SET:RAD:BAND:LINK?
Notes:	SCPI is supported after A.09.40
Preset:	DOWN
Range:	DOWN UP
Initial S/W Revision:	A.05.00
Help Map ID:	35685

Channel

Allows you to specify the frequency of the current step via a channel number.

Key Path:	Source, List Sequencer, List Sequencer Setup
Remote Command:	:SOURCE:LIST:STEP [1] 2 3...1000:SETup:CNFRequency <double> :SOURCE:LIST:STEP [1] 2 3...1000:SETup:CNFRequency?
Example:	SOUR:LIST:STEP2:SET:CNFR 124 SOUR:LIST:STEP2:SET:CNFR?

Common Measurement Functions 1

Notes:	SCPI is supported after A.09.40. This SCPI is used to setup channel number or frequency setting, according to current Radio Band setting. If Radio Band is “NONE”, then it’s frequency. If Radio Band is not “NONE”, then it’s channel number.
Couplings:	The channel number is coupled to the step frequency value. When the step frequency value is changed, the channel number will increase or decrease to match the new step frequency. If the step frequency is not at an exact match for a channel number, the nearest channel number is displayed, along with a greater than, or less than sign to indicate the frequency is above or below the channel number.
Preset:	1
Min:	0 (Please refer to for valid ranges.)
Max:	10838 (Please refer to for valid ranges.)
Initial S/W Revision:	A.05.00
Help Map ID:	35619

Frequency

Allows you to specify a frequency value for the current step.

Key Path:	Source, List Sequencer, List Sequencer Setup
Remote Command:	:SOURce:LIST:STEP [1] 2 3...1000:SETup:CNFRfrequency <double> :SOURce:LIST:STEP [1] 2 3...1000:SETup:CNFRfrequency?
Example:	SOUR:LIST:STEP2:SET:CNFR 1GHz SOUR:LIST:STEP2:SET:CNFR?
Notes:	SCPI is supported after A.09.40. This SCPI is used to setup channel number or frequency setting, according to current Radio Band setting. If Radio Band is “NONE”, then it’s frequency. If Radio Band is not “NONE”, then it’s channel number.
Couplings:	The frequency value is coupled to the channel band and number for the step, such that updates to the radio band and channel number will update the frequency value to the corresponding absolute frequency. The reverse is also true, changing the frequency value causes the value of the channel number to be updated.
Preset:	1.00 GHz
Min:	10.00 MHz
Max:	Hardware Dependant: Option 503 = 3.6 GHz Option 504 = 3.8 GHz

Initial S/W Revision:	A.05.00
Help Map ID:	35620

Power

Allows you to specify a power value for the current step.

Key Path:	Source, List Sequencer, List Sequencer Setup
Remote Command:	:SOURce:LIST:STEP [1] 2 3...1000:SETup:AMPLitude <double> :SOURce:LIST:STEP [1] 2 3...1000:SETup:AMPLitude?
Example:	SOUR:LIST:STEP2:SET:AMPL -50dBm SOUR:LIST:STEP2:SET:AMPL?
Notes:	SCPI is supported after A.09.40
Notes:	Amplitude corrections can be specified for use with the source. In the event of amplitude corrections being applied, the valid ranges for the RF power do not change dependant on the current amplitude correction setting. Instead, if the combination of RF power + amplitude correction is higher or lower than the source output range, the Source Unleveled bit is set and the “Source Unleveled” indicator will appear on status panel to indicate that the source cannot maintain the output power that has been requested.
Notes:	The Min and Max value here defined UI settable amplitude range. This range is larger than actual amplitude range with level accuracy defined in spec.
Dependencies:	The RF power is dependent on the RF output port and frequency, such that the current frequency and selected output port determine the valid range of power values.
Preset:	-100 dBm
Min:	The range of values depends on the current frequency and selected RF output port. Please refer to “RF Power” on page 1498 and the table RF Power Range for the valid ranges.
Max:	The range of values depends on the current frequency and selected RF output port. Please refer to “RF Power” on page 1498 and the table RF Power Range for the valid ranges.
Initial S/W Revision:	A.05.00
Help Map ID:	35621

Waveform

Allows you access to the sub-menus for selecting the waveform to be played back during the current step. Pressing this key also changes the central display area to show the Waveform File Selection view.

Key Path:	Source, List Sequencer, List Sequencer Setup
-----------	---

Common Measurement Functions 1

Remote Command:	:SOURce:LIST:STEP [1] 2 3...1000:SETup:WAVEform <string> :SOURce:LIST:STEP [1] 2 3...1000:SETup:WAVEform?
Example:	SOUR:LIST:STEP2:SET:WAV "CW" SOUR:LIST:STEP2:SET:WAV?
Notes:	SCPI is supported after A.09.40
Remote Command Notes:	String type, takes "Off" "CW" "Cont" "waveform name"
Preset:	CW
Range:	Waveform Continue Previous CW Off
Initial S/W Revision:	A.05.00
Help Map ID:	35622

CW

Sets the current step to output a CW tone.

Key Path:	Source, List Sequencer, List Sequencer Setup, Waveform
Example:	SOUR:LIST:STEP2:SET:WAV "CW"
Notes:	SCPI is supported after A.09.40
Initial S/W Revision:	A.05.00
Help Map ID:	35625

Selected Waveform

Inserts the currently selected waveform in the waveform selection view as the waveform for playback during the current step.

Key Path:	Source, List Sequencer, List Sequencer Setup, Waveform
Example:	SOUR:LIST:STEP2:SET:WAV "waveform name"
Notes:	SCPI is supported after A.09.40 If the selected waveform contains header (which contains ARB play parameters), source list sequence will automatically apply header settings of the selected waveform in that step.
Initial S/W Revision:	A.05.00
Help Map ID:	35623

Continue Previous

Sets the current step to continue with playback of the waveform from the previous step. When continuing the previous waveform, the ARB playback will not pause while the source retunes to the new frequency or amplitude

that may be defined for the new step.

Key Path:	Source, List Sequencer, List Sequencer Setup, Waveform
Example:	SOUR:LIST:STEP2:SET:WAV "Cont"
Notes:	SCPI is supported after A.09.40
Initial S/W Revision:	A.05.00
Help Map ID:	35624

Off

Disable RF output of the current step.

Key Path:	Source, List Sequencer, List Sequencer Setup, Waveform
Example:	SOUR:LIST:STEP2:SET:WAV "Off"
Notes:	SCPI is supported after A.09.40
Initial S/W Revision:	A.05.00
Help Map ID:	35683

Segments on Hard Disk

This key functions the same as [Segments on Hard Disk@35433](#).

Key Path:	Source, List Sequencer, List Sequencer Setup, Waveform
Initial S/W Revision:	Prior to A.09.00
Help Map ID:	0

Load Segment To ARB Memory

This key functions the same as [Load Segment To ARB Memory@35434](#).

Key Path:	Source, List Sequencer, List Sequencer Setup, Waveform, Segment on Hard Drive
Initial S/W Revision:	Prior to A.09.00
Help Map ID:	0

Load All To ARB Memory

This key functions the same as [Load All To ARB Memory@35435](#).

Key Path:	Source, List Sequencer, List Sequencer Setup, Waveform, Segment on Hard Drive
Initial S/W Revision:	Prior to A.09.00
Help Map ID:	0

Common Measurement Functions 1

Change Directory ...

This key functions the same as [Change Directory...@35436](#).

Key Path:	Source, List Sequencer, List Sequencer Setup, Waveform, Segment on Hard Drive
Initial S/W Revision:	Prior to A.09.00
Help Map ID:	0

Default Directory ...

This key functions the same as [Default Directory...@35437](#)

Key Path:	Source, List Sequencer, List Sequencer Setup, Waveform, Segment on Hard Drive
Initial S/W Revision:	Prior to A.09.00
Help Map ID:	0

Segments in ARB Memory

This key functions the same as [Segments in ARB Memory@35438](#).

Key Path:	Source, List Sequencer, List Sequencer Setup, Waveform, Segments in ARB Memory
Initial S/W Revision:	Prior to A.09.00
Help Map ID:	0

Delete Segment From ARB Memory

This key functions the same as [Delete Segment From ARB Mem@35439](#).

Key Path:	Source, List Sequencer, List Sequencer Setup, Waveform, Segments in ARB Memory, Segment in ARB Memory
Initial S/W Revision:	Prior to A.09.00
Help Map ID:	0

Delete All From ARB Memory

This key functions the same as [Delete All From ARB Memory@35440](#).

Key Path:	Source, List Sequencer, List Sequencer Setup, Waveform, Segments in ARB Memory, Segment in ARB Memory
Initial S/W Revision:	Prior to A.09.00
Help Map ID:	0

Step Duration

Allows access to the sub-menus for setting up the duration of play for the current step.

The duration can be set to be either the number of times for the ARB file associated with the sequence to play, or a specific time value, or continuous. If the step is set to play a CW tone, the step duration cannot be set to a play count.

Key Path:	Source, List Sequencer, List Sequencer Setup
Remote Command:	:SOURce:LIST:STEP [1] 2 3...1000:SETup:DURation:TYPE TIME COUNT CONTInuous :SOURce:LIST:STEP [1] 2 3...1000:SETup:DURation:TYPE?
Example:	SOUR:LIST:STEP2:SET:DUR:TYPE TIME SOUR:LIST:STEP2:SET:DUR:TYPE?
Notes:	SCPI is supported after A.09.40
Notes:	If “Step Duration” is set to “Time” or “Play Count” for the last step, the last step of ARB keeps playing as if set to “Continuous”, until the set “Time” has expired or until the “Play Count” setting is reached.
Range:	Time Play Count Continuous
Initial S/W Revision:	A.05.00
Help Map ID:	35626

Time

Sets the duration of the current step to be a time value for the length of time the step will play. Pressing this key again opens another menu which allows you to set the time value for the step duration.

Key Path:	Source, List Sequencer, List Sequencer Setup, Step Duration
Example:	SOUR:LIST:STEP2:SET:DUR:TYPE TIME
Notes:	SCPI is supported after A.09.40
Initial S/W Revision:	A.05.00
Help Map ID:	35627

Duration Time

Allows you to specify the length of time the current step will play.

If the Transition Time value is longer than the Step Duration Time, an error is generated when initiating a source list sequence. For source list sequence, transition time is included in the step duration length. If the Transition Time value is longer than the Step Duration Time, the real step duration length is extended to equal the transition time and cause a timing shift.

Key Path:	Source, List Sequencer, List Sequencer Setup, Step Duration, Time
-----------	--

Common Measurement Functions 1

Remote Command:	:SOURce:LIST:STEP [1] 2 3...1000:SETup:DURation:TCOUNT <double> :SOURce:LIST:STEP [1] 2 3...1000:SETup:DURation:TCOUNT?
Example:	SOUR:LIST:STEP2:SET:DUR:TCO 1s SOUR:LIST:STEP2:SET:DUR:TCO?
Notes:	SCPI is supported after A.09.40 This SCPI is reused by “Play Count” and “Duration Time” according to current Duration Type setting if “Play Count” or “Duration Time”. If current “Duration Type” is “Continuous”, then popup error -221, "Settings conflict; Cannot accept time or count input when step duration type is Continuous on step #"
Notes:	If “Duration Time” is set for the last step, the last step of ARB keeps playing as if set to “Continuous” after set time expires. However, you can query Source Sweeping Condition Message (:STAT:OPER:COND?) to find out if the current list sequence is complete or not.
Preset:	1.00 ms
Min:	100 µs
Max:	1800 s
Initial S/W Revision:	A.05.00
Help Map ID:	35628

Play Count

Sets the duration of the current step to be an integer value for the number of times (play count) the ARB file is selected for playback during this step. For example, a 5 second ARB will be set to play 5 times during the step.

Key Path:	Source, List Sequencer, List Sequencer Setup, Step Duration
Example:	SOUR:LIST:STEP2:SET:DUR:TYPE COUN
Notes:	SCPI is supported after A.09.40 This key is unavailable and is grayed out if the current step is configured to CW tone rather than an ARB waveform.
Initial S/W Revision:	A.05.00
Help Map ID:	35684

Play Count

Allows you to specify the number of times the current ARB waveform file will play during a step.

Key Path:	Source, List Sequencer, List Sequencer Setup, Step Duration, Time, Play Count
-----------	--

Remote Command:	:SOURCE:LIST:STEP [1] 2 3...1000:SETup:DURation:TCOUNT <double> :SOURCE:LIST:STEP [1] 2 3...1000:SETup:DURation:TCOUNT?
Example:	SOUR:LIST:STEP2:SET:DUR:TCO 10 SOUR:LIST:STEP2:SET:DUR:TCO?
Notes:	SCPI is supported after A.09.40 This SCPI is reused by “Play Count” and “Duration Time” according to current Duration Type setting if “Play Count” or “Duration Time”. If current “Duration Type” is “Continuous”, then popup error -221, "Settings conflict; Cannot accept time or count input when step duration type is Continuous on step #"
Notes:	If “Play Count” is set for the last step, the last step of ARB keeps playing as if set to “Continuous” after play count setting is reached.
Preset:	1
Min:	1
Max:	65536
Initial S/W Revision:	A.05.00
Help Map ID:	35629

Continuous

Sets the current step to be played continuously until the next step starts.

Key Path:	Source, List Sequencer, List Sequencer Setup, Step Duration
Example:	SOUR:LIST:STEP2:SET:DUR:TYPE CONT
Notes:	SCPI is supported after A.09.40
Initial S/W Revision:	A.05.00
Help Map ID:	35630

Output Trigger

Allows you to specify the trigger output for the current step. The trigger output signal is sent at the start of the step. When select “On”, trigger event will occur on both Internal and External2 paths. Select “Off” will turn off trigger output.

Key Path:	Source, List Sequencer, List Sequencer Setup
Remote Command:	:SOURCE:LIST:STEP [1] 2 3...1000:SETup:OUTPut:TRIGger ON OFF 1 0 :SOURCE:LIST:STEP [1] 2 3...1000:SETup:OUTPut:TRIGger

Common Measurement Functions 1

Example:	SOUR:LIST:STEP2:SET:OUTP:TRIG ON SOUR:LIST:STEP2:SET:OUTP:TRIG?
Notes:	SCPI is supported after A.09.40
Preset:	Off
Range:	On Off
Initial S/W Revision:	A.05.00
Help Map ID:	35633

Step Configuration (Remote Command Only)

This SCPI command is used to configure the List Sequencer and is detailed in the table below. The command is defined such that you send one command per step, with the step number being specified as a subopcode of the SCPI command. Each command includes all the parameter settings for the step. As a step is setup, the values entered are run through several levels of validation.

Remote Command:	:SOURce:LIST:STEP[1] 2 3 4..1000:SETup IMMediate INTernal KEY BUS EXTernal2, <time>, NONE PGSM EGSM RGSM DCS1800 PCS1900 TGSM810 GSM450 GSM4 80 GSM700 GSM850 BANDI BANDII BANDIII BANDIV BANDV BAND VI BANDVII BANDVIII BANDIX BANDX BANDXI BANDXII BANDXII I BANDXIV USCELL USPCS JAPAN KOREAN NMT IMT2K UPPER SEC OND PAMR400 PAMR800 IMTEXT PCS1DOT9G AWS US2DOT5G PUBLI C LOWER NONE BAND1 BAND2 BAND3 BAND4 BAND5 BAND6 BAND7 BAND8 BAND10 BAND11 BAND12 BAND13 BAND14 BAND17 BAND18 BAND19 BAND20 BAND21 BAND24 BAND25 BAND26 BAND33 BAND34 BAND35 BAND36 BAND37 BAND38 BAND39 BAND40 BAND41 BAND4 2 BAND43 BANDA BANDB BANDC BANDD BANDE BANDF, DOWN UP, <freq>, <ampl>, <string>, TIME COUNT CONTinuous, <time>, ON OFF 1 0, [<int>], :SOURce:LIST:STEP[1] 2 3 4..1000:SETup?
Example:	SOUR:LIST:STEP1:SET INT, 1ms, PGSM, DOWN, 10, -25 dBm, "GSM_Test1.bin", TIME, 10ms, OFF, 255

<p>Notes:</p>	<p>The parameters are: (There is a total of 11 items in each step, the following is a list of the items in the order they must appear in the remote command.)</p> <ol style="list-style-type: none"> 1. Step Trigger <enum> - specifies the input trigger for the step. For details of the valid types of step trigger see “Step Trigger” on page 1590. 2. Transition Time <time> - specifies the transition time for the step in seconds. For details of the valid ranges for the transition time see “Transition Time” on page 1592. 3. Radio Band <enum> - specifies the radio band for the step. For details of the valid radio bands see “Radio Setup” on page 1593. 4. Radio Band Link <enum> - specifies the radio band link direction for the step. For details of the valid link types, see “Radio Band Link” on page 1611. 5. Frequency/Channel Number <freq>/<chan num> - specifies the frequency in Hz or the channel number for the step. The channel number and frequency are combined as one parameter that represents the frequency or channel number depending on the radio band setting. If the radio band is set to NONE, this value is interpreted as a frequency value in Hz. If the radio band is set to a valid band, this value is interpreted as a channel number. For details of the valid ranges for frequency and channel numbers, see “Channel” on page 1611 and “Frequency” on page 1612. 6. Power <ampl> - specifies the output power for the step in dBm. For details of the valid ranges see “Power” on page 1613. 7. Waveform <string> - specifies the waveform for playback during the step. The step can output either a new ARB waveform, continue playback of the previous waveform, or output a CW tone. The options for specifying these are: <filename> - plays the specified waveform from the start. The filename value is the name of the file within ARB playback memory, it does not include the windows path to the file on the HDD. If you enter a filename for a waveform that does not reside within ARB playback memory, an error is generated. CONT – continues playback of the ARB file from the previous step CW – outputs a CW tone OFF – disable RF output 8. Step Duration <enum> - specifies the duration of the step. The duration can be specified to be either time, or play count of the ARB file associated with the step, or continuous. If Waveform is set to “CW”, this value cannot be set to Play Count and an error will be generated. If continuous is selected, the following Time or Count value is ignored. For further details of this setting, see “Step Duration” on page 1617. 9. Time or Count <time/int> - specifies time duration in seconds or play count of the ARB file associated with the step. For further details of this setting, including the valid ranges for the time or play count setting, “Time” on page 1617 and “Play Count” on page 1618. 10. Output Trigger <Boolean> - specifies the output trigger for the step. For details of the ranges for this setting see “Output Trigger” on page 1619.
---------------	--

Common Measurement Functions 1

Dependencies:	The range of subopcode values is 1 to 1000 and the value you enter is determined by the number of steps you have configured. For details see “Number of Steps” on page 1588 . If you attempt to remotely set or query a subopcode that is out of range, an error is generated.
Initial S/W Revision:	A.05.00
Help Map ID:	35692

Step Configuration of Step Trigger parameter list (Remote Command Only)

This SCPI command is to configure “Step Trigger” parameter array of the whole List Sequencer at one time. The number of array is same as step number defined in [“Number of Steps” on page 1588](#) Number of Steps. As a step is setup, the value entered run through several levels of validation.

Remote Command:	:SOURCE:LIST:SETup:INPut:TRIGger <enum>, <enum>, <enum>, ... :SOURCE:LIST:SETup:INPut:TRIGger?
Example:	SOUR:LIST:SET:INP:TRIG IMM,INT,EXT2 SOUR:LIST:SET:INP:TRIG?
Notes:	The command is to setup below parameter array of whole list sequence. Step Trigger <enum> - specifies the input trigger for the step. For details of the valid types of step trigger see “Step Trigger” on page 1590 . If input parameter number exceeds the step number defined by Number of Steps then generate error ", and only those parametes whose index number falls in number of steps will be updated.
Remote Command Notes:	IMMEDIATE INTERNAL KEY BUS EXTERNAL2
Dependencies:	The range is 1 to 1000 which is determined by the number of steps you have configured. For details see “Number of Steps” on page 1588 .
Initial S/W Revision:	A.09.40
Help Map ID:	0

Step Configuration of Transition Time parameter list (Remote Command Only)

This SCPI command is to configure “Transition Time” parameter array of the whole List Sequencer at one time. The number of array is same as step number defined in [“Number of Steps” on page 1588](#) Number of Steps. As a step is setup, the value entered run through several levels of validation.

Remote Command:	:SOURCE:LIST:SETup:TRANSition:TIME <time>, <time>, <time>, ... :SOURCE:LIST:SETup:TRANSition:TIME?
Example:	SOUR:LIST:SET:TRAN:TIME 1ms,1ms,1ms SOUR:LIST:SET:TRAN:TIME?

Notes:	The command is to setup below parameter array of whole list sequence. Transition Time <time> - specifies the transition time for the step in seconds. For details of the valid ranges for the transition time see “Transition Time” on page 1592 If input parameter number exceeds the step number defined by Number of Steps then generate error ", and only those parameters whose index number falls in number of steps will be updated.
Dependencies:	The range is 1 to 1000 which is determined by the number of steps you have configured. For details see “Number of Steps” on page 1588 .
Initial S/W Revision:	A.09.40
Help Map ID:	0

Step Configuration of Radio Band parameter list (Remote Command Only)

This SCPI command is to configure “Radio Band” parameter array of the whole List Sequencer at one time. The number of array is same as step number defined in [“Number of Steps” on page 1588](#) Number of Steps. As a step is setup, the value entered run through several levels of validation.

Remote Command:	:SOURCE:LIST:SETup:RADio:BAND <enum>, <enum>, <enum>, ... :SOURCE:LIST:SETup:RADio:BAND?
Example:	SOUR:LIST:SET:RAD:BAND PGSM, EGSM, RGSM SOUR:LIST:SET:RAD:BAND?
Notes:	The command is to setup below parameter array of whole list sequence. Radio Band <enum> - specifies the radio band for the step. For details of the valid radio bands see “Radio Setup” on page 1593 . If input parameter number exceeds the step number defined by Number of Steps then generate error ", and only those parameters whose index number falls in number of steps will be updated.
Remote Command Notes:	NONE PGSM EGSM RGSM DCS1800 PCS1900 TGSM810 GSM450 GSM480 GSM700 GSM850 BANDI BANDII BANDIII BANDIV BANDV BANDVI BANDVII BANDVIII BANDIX BANDX BANDXI BANDXII BANDXIII BANDXIV USCELL USPCS JAPAN KOREAN NMT IMT2K UPPER SECOND PAMR400 PAMR800 IMTEXT PCS1DOT9G AWS US2DOT5G PUBLIC LOWER NONE BAND1 BAND2 BAND3 BAND4 BAND5 BAND6 BAND7 BAND8 BAND10 BAND11 BAND12 BAND13 BAND14 BAND17 BAND18 BAND19 BAND20 BAND21 BAND24 BAND25 BAND26 BAND33 BAND34 BAND35 BAND36 BAND37 BAND38 BAND39 BAND40 BAND41 BAND42 BAND43 BANDA BANDB BANDC BANDD BANDE BANDF
Dependencies:	The range is 1 to 1000 which is determined by the number of steps you have configured. For details see “Number of Steps” on page 1588 .
Initial S/W Revision:	A.09.40
Help Map ID:	0

Common Measurement Functions 1

Step Configuration of Radio Band Link parameter list (Remote Command Only)

This SCPI command is to configure “Radio Band Link” parameter array of the whole List Sequencer at one time. The number of array is same as step number defined in “[Number of Steps](#)” on page 1588 Number of Steps. As a step is setup, the value entered run through several levels of validation.

Remote Command:	:SOURce:LIST:SETup:RADio:BAND:LINK <enum>, <enum>, <enum>, ... :SOURce:LIST:SETup:RADio:BAND:LINK?
Example:	SOUR:LIST:SET:RAD:BAND:LINK DOWN,UP,UP SOUR:LIST:SET:RAD:BAND:LINK?
Notes:	The command is to setup below parameter array of whole list sequence. Radio Band Link <enum> - specifies the radio band link direction for the step. For details of the valid link types, see “ Radio Band Link ” on page 1611. If input parameter number exceeds the step number defined by Number of Steps then generate error ", and only those parametes whose index number falls in number of steps will be updated.
Remote Command Notes:	DOWN UP
Dependencies:	The range is 1 to 1000 which is determined by the number of steps you have configured. For details see “ Number of Steps ” on page 1588.
Initial S/W Revision:	A.09.40
Help Map ID:	0

Step Configuration of Frequency/Channel Number parameter list (Remote Command Only)

This SCPI command is to configure “Frequency” or “Channel Number” parameter array of the whole List Sequencer at one time. The number of array is same as step number defined in “[Number of Steps](#)” on page 1588 Number of Steps. As a step is setup, the value entered run through several levels of validation.

Remote Command:	:SOURce:LIST:SETup:CNFRrequency <double>, <double>, <double>, ... :SOURce:LIST:SETup:CNFRrequency?
Example:	SOUR:LIST:SET:CNFR 1GHz,100MHz,100MHz SOUR:LIST:SET:CNFR? SOUR:LIST:SET:CNFR 124,124,124 SOUR:LIST:SET:CNFR?

Notes:	<p>The command is to setup below parameter array of whole list sequence.</p> <p>Frequency/Channel Number <freq>/<chan num> - specifies the frequency in Hz or the channel number for the step. The channel number and frequency are combined as one parameter that represents the frequency or channel number depending on the radio band setting. If the radio band is set to NONE, this value is interpreted as a frequency value in Hz. If the radio band is set to a valid band, this value is interpreted as a channel number. For details of the valid ranges for frequency and channel numbers, see “Channel” on page 1611 and “Frequency” on page 1612</p> <p>This SCPI is used to setup/query channel number or frequency setting, according to current Radio Band setting of that step. If Radio Band is “NONE”, then it’s frequency. If Radio Band is not “NONE”, then it’s channel number</p> <p>If input parameter number exceeds the step number defined by Number of Steps then generate error ", and only those parametes whose index number falls in legal step number will be updated.</p>
Dependencies:	The range is 1 to 1000 which is determined by the number of steps you have configured. For details see “Number of Steps” on page 1588 .
Initial S/W Revision:	A.09.40
Help Map ID:	0

Step Configuration of Power parameter list (Remote Command Only)

This SCPI command is to configure “Power”parameter array of the whole List Sequencer at one time. The number of array is same as step number defined in [“Number of Steps” on page 1588](#) Number of Steps. As a step is setup, the value entered run through several levels of validation.

Remote Command:	<pre>:SOURce:LIST:SETup:AMPLitude <ampl>, <ampl>, <ampl>, ... :SOURce:LIST:SETup:AMPLitude?</pre>
Example:	<pre>SOUR:LIST:SET:AMPL -50dBm,-40dBm,-30dBm SOUR:LIST:SET:AMPL?</pre>
Notes:	<p>The command is to setup below parameter array of whole list sequence.</p> <p>Power <ampl> - specifies the output power for the step in dBm. For details of the valid ranges see “Power” on page 1613.</p> <p>If input parameter number exceeds the step number defined by Number of Steps then generate error ", and only those parametes whose index number falls in legal step number will be updated.</p>
Dependencies:	The range is 1 to 1000 which is determined by the number of steps you have configured. For details see “Number of Steps” on page 1588 .
Initial S/W Revision:	A.09.40
Help Map ID:	0

Common Measurement Functions 1

Step Configuration of Waveform parameter list (Remote Command Only)

This SCPI command is to configure “Waveform” parameter array of the whole List Sequencer at one time. The number of array is same as step number defined in “Number of Steps” on page 1588 Number of Steps. As a step is setup, the value entered run through several levels of validation.

Remote Command:	:SOURce:LIST:SETup:WAVEform <string>, <string>, <string>, ... :SOURce:LIST:SETup:WAVEform?
Example:	SOUR:LIST:SET:WAV “CW”,”Off”,”CONT” SOUR:LIST:SET:WAV?
Notes:	The command is to setup below parameter array of whole list sequence. Waveform <string> - specifies the waveform for playback during the step. The step can output either a new ARB waveform, continue playback of the previous waveform, or output a CW tone. The options for specifying these are: <filename> - plays the specified waveform from the start. The filename value is the name of the file within ARB playback memory, it is does not include the windows path to the file on the HDD. If you enter a filename for a waveform that does not reside within ARB playback memory, an error is generated. CONT – continues playback of the ARB file from the previous step CW – outputs a CW tone OFF – disable RF output If input parameter number exceeds the step number defined by Number of Steps then generate error ", and only those parametes whose index number falls in number of steps will be updated.
Dependencies:	The range is 1 to 1000 which is determined by the number of steps you have configured. For details see “Number of Steps” on page 1588.
Range:	”filename” “CW” “Off” “CONT”
Initial S/W Revision:	A.09.40
Help Map ID:	0

Step Configuration of Step Duration parameter list (Remote Command Only)

This SCPI command is to configure “Step Duration” parameter array of the whole List Sequencer at one time. The number of array is same as step number defined in “Number of Steps” on page 1588 Number of Steps. As a step is setup, the value entered run through several levels of validation.

Remote Command:	:SOURce:LIST:SETup:DURation:TYPE <enum>, <enum>, <enum>, ... :SOURce:LIST:SETup:DURation:TYPE?
Example:	SOUR:LIST:SET:DUR:TYPE COUN,TIME,CONT SOUR:LIST:SET:DUR:TYPE?

Notes:	<p>The command is to setup below parameter array of whole list sequence.</p> <p>Step Duration <enum> - specifies the duration of the step. The duration can be specified to be either time, or play count of the ARB file associated with the step, or continuous. If Waveform is set to “CW”, this value cannot be set to Play Count and an error will be generated. If continuous is selected, the following Time or Count value is ignored. For further details of this setting, see “Step Duration” on page 1617.</p> <p>If input parameter number exceeds the step number defined by Number of Steps then generate error ", and only those parametes whose index number falls in number of steps will be updated.</p>
Remote Command Notes:	TIME COUNT CONTInuous
Dependencies:	The range is 1 to 1000 which is determined by the number of steps you have configured. For details see “ Number of Steps ” on page 1588.
Initial S/W Revision:	A.09.40
Help Map ID:	0

Step Configuration of Duration Time or Play Count parameter list (Remote Command Only)

This SCPI command is to configure “Duration Time” or “Play Count” parameter array of the whole List Sequencer at one time. The number of array is same as step number defined in “[Number of Steps](#)” on page 1588 Number of Steps. As a step is setup, the value entered run through several levels of validation.

Remote Command:	<pre>:SOURCE:LIST:SETup:TOCount <time/int>, <time/int>, <time/int>, ... :SOURce:LIST:SETup:TOCount?</pre>
Example:	<pre>SOUR:LIST:SET:TOC 1s,2s,3s SOUR:LIST:SET:TOC? SOUR:LIST:SET:TOC 5,6,7 SOUR:LIST:SET:TOC?</pre>
Notes:	<p>The command is to setup below parameter array of whole list sequence.</p> <p>Time or Count <time/int> - specifies time duration in seconds or play count of the ARB file associated with the step. For further details of this setting, including the valid ranges for the time or play count setting, “Time” on page 1617 and “Play Count” on page 1618.</p> <p>If input parameter number exceeds the step number defined by Number of Steps then generate error ", and only those parametes whose index number falls in number of steps will be updated.</p> <p>If current “Step Duration” on page 1617 is “Continuous”, then generate error -221,"Settings conflict;Cannot accept time or count input when step duration type is Continuous on step #"</p>
Dependencies:	The range is 1 to 1000 which is determined by the number of steps you have configured. For details see “ Number of Steps ” on page 1588.

Common Measurement Functions 1

Initial S/W Revision:	A.09.40
Help Map ID:	0

Step Configuration of Output Trigger parameter list (Remote Command Only)

This SCPI command is to configure “Output Trigger” parameter array of the whole List Sequencer at one time. The number of array is same as step number defined in “[Number of Steps](#)” on page 1588 Number of Steps. As a step is setup, the value entered run through several levels of validation.

Remote Command:	:SOURce:LIST:SETup:OUTPut:TRIGger <bool>, <bool>, <bool>, ... :SOURce:LIST:SETup:OUTPut:TRIGger ?
Example:	SOUR:LIST:SET:OUTP:TRIG ON,OFF,ON SOUR:LIST:SET:OUTP:TRIG?
Notes:	The command is to setup below parameter array of whole list sequence. Output Trigger <Boolean> - specifies the output trigger for the step. For details of the ranges for this setting see “ Output Trigger ” on page 1619. If input parameter number exceeds the step number defined by Number of Steps then generate error ", and only those parametes whose index number falls in legal step number will be updated.
Remote Command Notes:	ON OFF 1 0
Dependencies:	The range is 1 to 1000 which is determined by the number of steps you have configured. For details see “ Number of Steps ” on page 1588.
Initial S/W Revision:	A.09.40
Help Map ID:	0

Clear List (Remote Command Only)

This command is the SCPI equivalent of the Clear List UI featuredescribed in.

Remote Command:	:SOURce:LIST:SETup:CLEAr
Example:	SOUR:LIST:SETup:CLE
Initial S/W Revision:	A.05.00
Help Map ID:	35693

Multiport Adapter Output Port Bitmap Mode

When this setting is set to LIST, it will allow you to select the multiport adapter output path of each step. When this setting is set to FIXed, source list sequence multiport adapter output path on each step is controlled by global multiport adapter output port bitmap setting (same as source independent mode). Under this situation, source list sequence will ignore local multiport adapter output port bitmap setting

defined in each step, they are still there and can be queried out, but take no effect.

Key Path:	Source, List Sequencer
Remote Command:	:SOURce:LIST:MPADapter:PORT:OUTPut:BITMap:MODE LIST FIXed :SOURce:LIST:MPADapter:PORT:OUTPut:BITMap:MODE?
Example:	SOUR:LIST:MPAD:PORT:OUTP:BITM:MODE LIST SOUR:LIST:MPAD:PORT:OUTP:BITM:MODE?
Preset:	FIXed
Range:	LIST FIXed
State Saved:	Yes
Initial S/W Revision:	A.09.40
Help Map ID:	35760

Multiport Adapter Output Port Amplitude Correction Configuration Validation for List Sequencer (Remote Command Only)

This command is used to validate MPA TX port amplitude correction for Source List Sequencer.

Key Path:	Source, List Sequencer
Remote Command:	:SOURce:LIST:MPADapter:CORRection:ERRor?
Example:	SOUR:LIST:MPAD:CORR:ERR?
Notes:	Query Only SCPI Remote command only If detected invalid configuration, popup error message: "-221 Settings conflict; Source List Step<n> MPA TX port<n> amplitude correction value <n>dB is out of range. The valid range is <n> ~ <n>dB" Or "-221 Settings conflict; Source List Step<n> MPA TX port<n> amplitude correction delta exceeds <n>dB between port<n> and port<n>" to report the first detected conflict.
Range:	"No error" Error info of the first found conflict
State Saved:	Yes
Initial S/W Revision:	A.12.00
Help Map ID:	0

Common Measurement Functions 1

Manual Trigger Now

Pressing this key provides a software trigger event to the list sequencer. During execution of sequence, if the sequencer is halted on any step that has been configured with a “Manual” step trigger, then this key press will cause the sequencer to continue and execute the step.

Key Path:	Source, List Sequencer
Remote Command:	No remote command, front panel only.
Initial S/W Revision:	A.05.00
Help Map ID:	35682

Query List Sequence Initiation Armed Status (Remote Command Only)

This is a blocking SCPI query to determine if source list sequence being initiated successfully or not.

Remote Command:	:SOURce:LIST:INITiation:ARMed?
Example:	SOUR:LIST:INIT:ARMed?
Notes:	The return data is in the following format: Integer
Notes:	Query only SCPI. Returning “1” if list sequence has been initiated successfully, returning “0” if not. Once get “0”, you can use :SYST:ERR? to query what error happened. Just like “*OPC?”, this command can be blocked until event/status “IsSourceSweeping” happens, and then returns. Doing so can help user’s script query armed status only once during the time interval of the initiation. As an ancillary SCPI of existing SCPI “:SOUR:LIST:TRIGger[:IMMediate]” (see “Initiate Sequence” on page 1587 Initiate Sequence), the right usage of this command is to use it after “:SOUR:LIST:TRIG”. If not, this command will return “1” immediately.
Notes:	There is an alias SCPI “:SOURce:LIST:TRIGger:INITiation:ARMed?”.
Initial S/W Revision:	A.09.40
Help Map ID:	35761

Source Preset

Allows you to preset the source settings to their default values.

Key Path:	Source
Remote Command:	:SOURce:PRESet
Example:	SOUR:PRES
Help Map ID:	35656

Source Self Test

Internal Source

This key in the System, Diagnostics menu gives you access to diagnostic capabilities of Internal Source of the instrument.

Key Path:	System, Diagnostics
Initial S/W Revision:	Prior to A.09.20
Help Map ID:	35762

Source Self Test

This key invokes internal source self test. When operation is complete, the generated test summary file is: E:\Agilent\Instrument\CRFSSelfTestLog.txt. This test summary file can be retrieved from the instrument using the MMEM set of SCPI command, once you have the fully qualified path and file name.

If self test fails, error message “-330, Self-test failed, see log file E:\Agilent\Instrument\CRFSSelfTestLog.txt” is generated. If self test passes, an advisory message “Source self-test completed successfully” is generated.

Key Path:	System, Diagnostics, Internal Source, Self Test
Remote Command:	:SOURce:SELF:TEST[:ALL]
Example:	SOUR:SELF:TEST
Notes:	MMEM:DATA? "E:\Agilent\Instrument\CRFSSelfTestLog.txt"
Initial S/W Revision:	A.09.20
Help Map ID:	35763

Recall

Most of the functions under this key work the same way in many measurements, so they are documented in the System Functions section. For details about this key, see [Recall@2637@i](#).

Save

Most of the functions under this key work the same way in many measurements, so they are documented in the Utility Functions section. For details about this key, see [Save@2600@i](#).

Signal Studio Commands

Overview

EXT supports connectivity with Signal Studio. To achieve this, the SCPI commands described in this chapter enable you to connect Signal Studio to the EXT test set and to download waveform into the hard disk. They are SCPI only, no menu

Initial S/W Revision:	A.05.00
Help Map ID:	35694

Common Measurement Functions 1

Query License List (Remote Command Only)

This query provides a listing of the current licenses for external software installed for the test set internal source.

Remote Command:	:SYSTem:LIcense:EXTernal:LIST?
Example:	SYST:LIC:EXT:LIST?
Notes:	Query only.
Initial S/W Revision:	A.05.00
Help Map ID:	35695

Query License List Detail (Remote Command Only)

This is an obsolete command for Signal Studio. However, it has not been removed from Signal Studio to prevent a Signal Studio connectivity time out. Using this command returns a null string and does not affect Signal Studio.

Remote Command:	:SYSTem:LIcense:LIST:DETail?
Example:	SYST:LIC:LIST:DET?
Notes:	Query only. Always returns a null string "".
Initial S/W Revision:	A.05.00
Help Map ID:	35696

Memory Subsystem (Remote Command Only)

To be compatible with other Signal Generator products, the EXT test set internal source provides a memory subsystem for Signal Studio to download waveform file into the instrument.

“NVWFM” (none-volatile storage) MSUS (Mass Storage Unit Specifier) is supported in the memory subsystem because the ARB memory cannot be accessed directly. Therefore, files must be downloaded to the instrument hard disk and then loaded into the ARB memory. “NVWFM” MSUS will be mapped to the default directory D:\NVARB.

In addition, you can load a waveform file from the hard disk to the ARB memory, using the [“Load Segment To ARB Memory”](#) on page 1538 remote command :SOURce:RADio:ARB:LOAD, which also supports using either “NVWFM” MSUS or specifying a full path.

Remote Command:	:MEMory [:SOURce]
Example:	MEM
Initial S/W Revision:	A.05.00
Help Map ID:	35697

:DATA (Remote Command Only)

This command loads data into the EXT test set hard disk using the <data> parameter and saves the data to a file designated by the <file_name> variable. For downloads to non-volatile waveform memory, use the path “NVWFM:<file_name>”.

Remote Command:	:MEMory[:SOURce]:DATA <file_name>, <data>
Example:	MEM:DATA “NVWFM:test.wfm”, #1212 or MEM:DATA “D:\NVARB\test.wfm”, #1212
Notes:	Data is in 488.2 block format. If a file already exists with same name, the file will be overwritten without warning.
Initial S/W Revision:	A.05.00
Help Map ID:	35698

:DATA:APPend (Remote Command Only)

This command appends data to an existing file stored in hard disk using the <data> parameter and saves the data to a file designated by the <file_name> variable. For downloads to non-volatile waveform memory, use the path “NVWFM:<file_name>”.

Remote Command:	:MEMory[:SOURce]:DATA:APPend <file_name>, <data>
Example:	MEM:DATA:APP “NVWFM:test.wfm”, #14Y9oL or MEM:DATA:APP “D:\NVARB\test.wfm”, #14Y9oL
Notes:	Data is in 488.2 block format. If no file exists with the name designated in the command, a file will be created the first time this command is used with that designated name.
Initial S/W Revision:	A.05.00
Help Map ID:	35699

Sequence Studio Commands

Overview

EXT supports connectivity with Sequence Studio. The SCPI commands described in this chapter are used to support connectivity from Sequence Studio to the EXT test set. These are only intended for Sequence Studio, so provided as service commands, and SCPI only, no menu

Initial S/W Revision	A.12.00
Help Map ID	0

Common Measurement Functions 1

Query Supportable System Information Query SCPI List (Remote Command Only)

This query provides a listing of the current EXT supportable list of query SCPI which is used to query EXT HW/SW information. It returns string result and parsed by Sequence Studio.

Sequence Studio needs to query some EXT system information like capability etc. when connecting. With more and more new SCPIs added in EXT FW, each time when Sequence Studio try to connect to an old version FW without those new SCPI commands, VISA timeout in Sequence Studio will occur and just make Sequence Studio looks dead. To avoid that, this SCPI is provided to give a list of current supportable information-query SCPI list.

Remote Command	:SERVICE[:PRODUCTION]:SIQuery:SCPI:LIST?
Example	SERV:SIQ:SCPI:LIST?
Notes	Query only The string in “Range” part cannot change, for Sequence Studio needs to accurately match those string character. If “SEQ Ver Info” string presents, then means “:SERVICE[:PRODUCTION]:LSEQuencer:ANALyzer:FILE:VERSion?” and “:SERVICE[:PRODUCTION]:LSEQuencer:SOURce:FILE:VERSion?” query SCPIs are supported in current version. If “ARB Header Info” string presents, that means “ Query Selected Waveform Header info (Remote Command Only) ” on page 1581 query SCPI is supported in current version.
Range	“HW Capability Info”, “SEQ Ver Info”, “ARB Header Info”
Initial S/W Revision	A.12.00
Help Map ID	0

Span

Activates the Span function and displays a menu of span functions.

Initial S/W Revision:	Prior to A.02.00
Help Map ID:	3260

Span

Changes the displayed frequency range symmetrically about the center frequency. While adjusting the Span the Center Frequency is held constant, which means that both Start Frequency and Stop Frequency will change.

Span also sets the frequency entry mode to Center/Span. In Center/Span mode, the center frequency and span values are displayed below the graticule, and the default active function in the Frequency menu is **Center Freq.**

While discussing the Span function we make the distinction between “swept spans” and “zero span”. We use the term “swept spans” to mean spans other than zero; recognizing that, because of this terminology, the user can be in what we call a “swept span” even while performing an FFT “sweep”.

While in swept spans, setting the span to 0 Hz through SCPI or the front panel numeric key pad puts the test set into zero span. However, using the Step keys and the RPG in swept spans, the Span can only go as far down as 10 Hz and cannot be set to zero.

While in zero span, setting the Span to a non-zero value through SCPI or the front panel puts the test set in swept spans.

If the Span is set to a value greater than the maximum allowable span of the test set, an error is generated indicating the data is out of range and was clipped to upper limit.

Key Path	SPAN X Scale
Remote Command	[:SENSe] :FREQuency:SPAN <freq> [:SENSe] :FREQuency:SPAN?
Example	FREQ:SPAN 2GHz sets the span to 2 GHz FREQ:SPAN 0 Hz sets the span to 0 Hz and puts the test set in Zero Span
Notes	Preset and Max values depend on the Hardware Options
Dependencies	If the electrical attenuator is enabled, any attempt to set Span such that the Stop Frequency would be >3.6 GHz results in an error. If the key is pressed, an advisory message is generated. If the equivalent SCPI command is sent, this same message is generated as part of a “-221, Settings conflict” warning.
Couplings	Span affects RBW, sweptime, FFT & Sweep choice (including FFT Width, Phase Noise Optimization and ADC Dither auto couplings.) When operating in “swept span”: <ul style="list-style-type: none"> Any value of the Center Frequency or Span that is within the frequency range of the test set is allowed when the value is being set through the front panel numeric key pad or the SCPI command. The other parameter is forced to a different value if needed, to keep the Start and the Stop Frequencies within the test set’s frequency range When using the knob or the step up/down keys or the UP DOWN keywords in SCPI, the value that is being changed i.e. the Center Frequency or Span, is limited so that the other parameter is not forced to a new value The Span cannot be set to Zero by setting Start Frequency = Stop Frequency. The value of the last setting is changed to maintain a minimum value of 10 Hz for the difference between start and stop frequencies.

Common Measurement Functions 1

Preset	Depends on test set maximum frequency: Option 503 (3 GHz models): 2.99 GHz Option 503 (3.6 GHz models): 3.59 GHz Option 507 (7 GHz models): 6.99 GHz Option 507 (7.5 GHz models): 7.49 GHz Option 508: 8.39 GHz Option 513: 13.59 GHz Option 526: 26.49 GHz
State Saved	Saved in State
Min	10 Hz unless entered directly, then 0 Hz is allowed, but nothing between 0 and 10 is ever allowed.
Max	Option 503 (3 GHz models): 3.08 GHz Option 503 (3.6 GHz models): 3.7 GHz Option 507 (7 GHz models): 7.1 GHz Option 507 (7.5 GHz models): 7.58 GHz Option 508: 8.5 GHz Option 513: 13.8 GHz Option 526: 27.0 GHz If the knob or step keys are being used, depends on the value of the other three interdependent parameters Center Frequency, Start Frequency, Stop Frequency
Default Unit	Hz
Status Bits/OPC dependencies	Overlapped if Signal Track is on (OPC shouldn't return or clear until the zooming has completed for the new span)
Initial S/W Revision	Prior to A.02.00
Help Map ID	3261

Full Span

Changes the frequency span of the test set to the Preset frequency span of the test set and sets the Frequency entry mode to Center/Span.

The span is dependent on the currently selected Input (see the Section "Input/Output").

Pressing this key while in zero span puts the test set back in swept span.

Key Path	SPAN X Scale
Remote Command	[:SENSE] :FREQUENCY:SPAN:FULL
Example	FREQ:SPAN:FULL sets the span to full frequency range of the test set

Notes	n /a
Couplings	Turns off signal tracking (span zoom). It does NOT turn off the markers, nor the current active function.
Initial S/W Revision	Prior to A.02.00
Help Map ID	3263

Zero Span

Changes the displayed frequency span to 0 Hz. The horizontal axis changes to time rather than frequency. The amplitude displayed is the input signal level at the current center frequency. This is a time-domain mode that changes several measurement functions and couplings. The test set behavior is similar to an oscilloscope with a frequency selective detector installed in front of the oscilloscope. See Application Note 150 for more information on how to use zero span.

You can enter Zero Span in several ways:

Press the Zero Span key in Span

Set Span = 0 Hz

Press last Span if the last span was 0

You cannot go to Zero Span by setting start freq = stop freq, or rolling span down with the RPG, that will limit you to 10 Hz

You can go back to Swept Span by setting Span to a nonzero value or pressing Last Span, assuming the last span was not also zero span.

Pressing Zero Span places the test set in Center/Span frequency entry mode.

The following table summarizes the differences between Zero Span and Swept Spans:

Zero Span	Swept Spans
X axis is time	X axis is frequency
There is no auto-RBW selection unless the EMC Standard is CISPR or MIL	RBW coupled to Span when RBW in auto
There is no auto sweep time	Sweep time coupled to RBW when sweep time in auto
Interval Power calculated in Mkr Function	Band Power calculated in Mkr Function
Can only define time limits when in zero span	Can only define frequency limits when in swept spectrum analysis
Marker Count counts at the center frequency	Marker Count counts at the marker frequency
CF Step Size set to RBW value	CF Step auto couples to 10% of Span
Some "Marker ->" commands not available.	Other "Marker ->" commands not available
Freq entry mode always Center/Span	Freq entry mode can be Center/Span or Start/Stop

Common Measurement Functions 1

N dB points reports a time difference.	N dB points reports a frequency difference.
--	---

Key Path	SPAN X Scale
Example	FREQ:SPAN 0 Hz sets the span to zero, switches to Zero Span Sending FREQ:SPAN 1 MHz while in Zero Span, switches to Swept span
Notes	Setting the Span to 0 Hz will change to Zero Span and setting the span to a non-zero value will select a swept span
Notes	n /a
Dependencies	Zero Span key is unavailable (grayed out) if the following is true: Frequency scale type is LOG (for example, Log Sweep is On)
Couplings	Pressing Zero Span key (switching to Zero Span): Turns off signal track function (span zoom). Turns off the auto-coupling of RBW and sweep time.
Initial S/W Revision	Prior to A.02.00
Help Map ID	3264

Last Span

Changes the displayed frequency span to the previous span setting. If it is pressed immediately after Signal Track is turned off, then the span setting returns to the span that was in effect before Signal Track was turned on.

If this key is pressed while in a nonzero span, and the previous value of span was 0, it will put the test set back in Zero Span. And if it is pressed while in zero span, it will set the test set back to its last nonzero span.

Pressing Last Span places the test set in Center/Span frequency entry mode.

Key Path	SPAN X Scale
Remote Command	[:SENSE] :FREQuency:SPAN:PREVious
Example	FREQ:SPAN:PREV sets the span to the previous value
Notes	n /a
Initial S/W Revision	Prior to A.02.00
Help Map ID	3265

Sweep/Control

Accesses a menu that enables you to configure the Sweep and Control functions of the test set, such as Sweep Time and Gating.

Key Path	Front-panel key
----------	-----------------

Initial S/W Revision	Prior to A.02.00
Help Map ID	3273

Sweep Time

Controls the time the test set takes to sweep the current frequency span when the Sweep Type is Swept, and displays the equivalent Sweep Time when the Sweep Type is FFT.

When Sweep Time is in Auto, the test set computes a sweep time which will give accurate measurements based on other settings of the test set, such as RBW and VBW.

NOTE The Meas Uncal (measurement uncalibrated) warning is given in the Status Bar in the lower right corner of the screen when the manual sweep time entered is faster than the sweep time computed by the test set’s sweep time equations, that is, the Auto Sweep Time. The test set’s computed sweep time will give accurate measurements; if you sweep faster than this your measurements may be inaccurate. A Meas Uncal condition may be corrected by returning the Sweep Time to Auto; by entering a longer Sweep Time; or by choosing a wider RBW and/or VBW

On occasion other factors such as the YTF sweep rate (in high band) or the LO’s capability (in low band) can cause a Meas Uncal condition. The most reliable way to correct it is to return the Sweep Time to Auto.

When Sweep Type is FFT, you cannot control the sweep time, it is simply reported by the test set to give you an idea of how long the measurement is taking.

Note that although some overhead time is required by the test set to complete a sweep cycle, the sweep time reported when Sweep Type is Swept does not include the overhead time, just the time to sweep the LO over the current Span. When Sweep Type is FFT, however, the reported Sweep Time takes into account both the data acquisition time and the processing time, in order to report an equivalent Sweep Time for a meaningful comparison to the Swept case.

Because there is no “Auto Sweep Time” when in zero span, the Auto/Man line on this key disappears when in Zero Span. The Auto/Man line also disappears when in an FFT sweep. In this case the key is grayed out as shown below.

Key Path	Sweep/Control
Remote Command	[:SENSE]:SWEep:TIME <time> [:SENSE]:SWEep:TIME? [:SENSE]:SWEep:TIME:AUTO OFF ON 0 1 [:SENSE]:SWEep:TIME:AUTO?
Example	SWE:TIME 500 ms SWE:TIME:AUTO OFF

Common Measurement Functions 1

Notes	The values shown in this table reflect the “swept spans” conditions which are the default settings after a preset. See “Couplings” for values in the zero span domain.
Dependencies	<p>The third line of the key (Auto/Man) disappears in Zero Span. The SCPI command SWEep:TIME:AUTO ON if sent in Zero Span generates an error message.</p> <p>Key grayed out and third line of the key (Auto/Man) disappears in FFT sweeps. Pressing the key or sending the SCPI for sweep time while the test set is in FFT sweep generates a –221, “Settings Conflict;” error. The SCPI command :SWEep:TIME:AUTO ON if sent in FFT sweeps generates an error.</p> <p>Grayed out while in Gate View, to avoid confusing those who want to set Gate View Sweep Time.</p> <p>Key is grayed out in Measurements that do not support swept mode.</p> <p>Key is blanked in Modes that do not support swept mode.</p> <p>Set to Auto when Auto Couple is pressed or sent remotely</p>
Couplings	<p>Sweep Time is coupled primarily to Span and RBW. Center Frequency, VBW, and the number of sweep points also can have an effect. So changing these parameters may change the sweep time.</p> <p>The Sweep Time used upon entry to Zero Span is the same as the Sweep Time that was in effect before entering Zero Span. The Sweep Time can be changed while in Zero Span. Upon leaving Zero Span, the Auto/Man state of Sweep Time that existed before entering Zero Span is restored.</p> <p>If Sweep Time was in Auto before entering Zero Span, or if it is set to Auto while in zero span (which can happen via remote command or if Auto Couple is pressed) it returns to Auto and recouples when returning to non-zero spans.</p> <p>If Sweep Time was in Man before entering Zero Span, it returns to Man when returning to non-zero spans, and any changes to Sweep Time that were made while in Zero Span are retained in the non-zero span (except where constrained by minimum limits, which are different in and out of zero span).</p>
Preset	The preset Sweep Time value is hardware dependent since Sweep Time presets to “Auto”.
State Saved	Saved in instrument state
Min	<p>in zero span: 1 μs</p> <p>in swept spans: 1 ms</p>
Max	<p>in zero span: 6000 s</p> <p>in swept spans: 4000 s</p>
Status Bits/OPC dependencies	Meas Uncal is Bit 0 in the STATus:QUEStionable:INTegrity:UNCalibrated register
Initial S/W Revision	Prior to A.02.00
Help Map ID	3274

Sweep Setup

Lets you set the sweep functions that control features such as sweep type and time.

Key Path	Sweep/Control
Dependencies	The whole Sweep Setup menu is grayed out in Zero Span, however, the settings in the menus under Sweep Setup can be changed remotely with no error indication. Grayed out in measurements that do not support swept mode. Blanked in modes that do not support swept mode
Initial S/W Revision	Prior to A.02.00
Help Map ID	3275

Sweep Time Rules

Allows the choice of three distinct sets of sweep time rules. These are the rules that are used to set the sweep time when **Sweep Time** is in **Auto mode**. Note that these rules only apply when in the Swept **Sweep Type** (either manually or automatically chosen) and not when in FFT sweeps.

See [“More Information” on page 1642](#).

Key Path	Sweep/Control, Sweep Setup
Remote Command	[:SENSE] :SWEep:TIME:AUTO:RULEs NORMal ACCuracy SRESponse [:SENSe] :SWEep:TIME:AUTO:RULEs?
Example	SWE:TIME:AUTO:RUL ACC
Dependencies	In Zero Span, this key is irrelevant and cannot be accessed (because the whole Sweep Setup menu is grayed out in Zero Span), however its settings can be changed remotely with no error indication. Grayed out in FFT sweeps. Pressing the key while the test set is in FFT sweep generates an advisory message. The SCPI is acted upon if sent, but has no effect other than to change the readout on the key, as long as the test set is in an FFT sweep.
Couplings	Set to Auto on Auto Couple
Preset	AUTO
State Saved	Saved in instrument state

Common Measurement Functions 1

Backwards Compatibility SCPI	<p>The old Auto Sweep Time command was the same [:SENSe]:SWEep:TIME:AUTO:RULEs NORMAl ACCuracy so it still works although it now has a third parameter (SRESponse).</p> <p>The old Sweep Coupling command was [:SENSe]:SWEep:TIME:AUTO:MODE SRESponse SANalyzer and it is aliased as follows:</p> <p>:SWEep:TIME:AUTO:MODE SRESponse is aliased to :SWEep:TIME:AUTO:RULEs SRESponse, and :SWEep:TIME:AUTO:MODE SANalyzer is aliased to :SWEep:TIME:AUTO:RULEs NORMAl</p> <p>The query :SWEep:TIME:AUTO:MODE? is aliased to :SWEep:TIME:RULEs?</p> <p>So it will fail to match for SANalyzer</p>
Initial S/W Revision	Prior to A.02.00
Help Map ID	3276

More Information

The first set of rules is called **SA – Normal. Sweep Time Rules** is set to **SA-Normal** on a **Preset** or **Auto Couple**. These rules give optimal sweep times at a loss of accuracy. Note that this means that in the Preset or Auto Coupled state, test set amplitude accuracy specifications do not apply.

Setting **Sweep Time Rules** to **SA-Accuracy** will result in slower sweep times than **SA-Normal**, usually about three times as long, but with better amplitude accuracy for CW signals. The test set absolute amplitude accuracy specifications only apply when **Sweep Time** is set to **Auto**, and **Sweep Time Rules** are set to **SA-Accuracy**. Additional amplitude errors which occur when **Sweep Time Rules** are set to **SA-Normal** are usually well under 0.1 dB, though this is not guaranteed. Because of the faster sweep times and still low errors, **SA-Normal** is the preferred setting of **Sweep Time Rules**.

The third set of sweep time rules is called **Stimulus/Response** and is automatically selected when an integrated source is turned on, such as a Tracking Generator or a synchronized external source. The sweep times for this set of rules are usually much faster for swept-response measurements. Stimulus-response auto-coupled sweep times are typically valid in stimulus-response measurements when the system's frequency span is less than 20 times the bandwidth of the device under test. You can select these rules manually (even if not making Stimulus-Response measurements) to get faster sweeps without the "Meas Uncal" warning, but you are then not protected from the over-sweep condition and may end up with uncalibrated results. However, it is commonplace in measuring non-CW signals such as noise to be able to get excellent measurement accuracy at sweep rates higher than those required for CW signal accuracy, so this is a valid measurement technique.

Auto

Sets the test set to automatically choose the Sweep Time Rules for the measurement.

Key Path	Sweep/Control, Sweep Setup, Sweep Time Rules
----------	---

Remote Command	[:SENSE] :SWEep:TIME:AUTO:RULes:AUTO[:STATe] ON OFF 1 0 [:SENSE] :SWEep:TIME:AUTO:RULes:AUTO[:STATe] ?
Example	:SWE:TIME:AUTO:RUL:AUTO ON
Couplings	Set on Preset or Auto Couple
Preset	ON
Initial S/W Revision	Prior to A.02.00
Help Map ID	3277

SA - Normal

Chooses Sweep Time Auto Rules for optimal speed and generally sufficient accuracy.

Key Path	Sweep/Control, Sweep Setup, Sweep Time Rules
Example	:SWE:TIME:AUTO:RUL NORM
Couplings	Automatically selected unless Source is on If directly selected, sets AUTO to Off
Readback	SA - Normal
Initial S/W Revision	Prior to A.02.00
Help Map ID	3278

SA - Accuracy

Chooses Sweep Time Auto Rules for specified absolute amplitude accuracy.

Key Path	Sweep/Control, Sweep Setup, Sweep Time Rules
Example	:SWE:TIME:AUTO:RUL ACC
Dependencies	Do not allow sweep time to fall below 20 ms when in SA - Accuracy
Couplings	If directly selected, sets AUTO to Off
Readback	SA - Accuracy
Initial S/W Revision	Prior to A.02.00
Help Map ID	3279

Stimulus/Response

Chooses Sweep Time Auto Rules for use with a source.

Key Path	Sweep/Control, Sweep Setup, Sweep Time Rules
Example	:SWE:TIME:AUTO:RUL SRES

Common Measurement Functions 1

Couplings	Automatically selected when Source is on If directly selected sets AUTO to Off
Readback	SR
Initial S/W Revision	Prior to A.02.00
Help Map ID	3280

Sweep Type

Chooses between the FFT and Sweep types of sweep.

Sweep Type refers to whether or not the instrument is in Swept or FFT analysis. When in Auto, the selection of sweep type is governed by two different sets of rules, depending on whether you want to optimize for dynamic range or for speed.

FFT “sweeps” should not be used when making EMI measurements; therefore, when a CISPR detector (Quasi Peak, EMI Average, RMS Average) is selected for any active trace (one for which Update is on), the FFT key in the Sweep Type menu is grayed out, and the Auto Rules only choose Swept. If Sweep Type is manually selected to be FFT, the CISPR detectors are all grayed out.

FFT sweeps will never be auto-selected when Screen Video, Log Video or Linear Video are the selected Analog Output.

Key Path	Sweep/Control, Sweep Setup
Remote Command	[:SENSe] :SWEep:TYPE FFT SWEep [:SENSe] :SWEep:TYPE?
Notes	For a backward compatibility, the following remote parameters AUTO SWP is supported by the [:SENSe]:SWEep:TYPE command.
Dependencies	In Zero Span, this key is irrelevant and cannot be accessed (because the whole Sweep Setup menu is grayed out in Zero Span), however its settings can be changed remotely with no error indication. When Gate is on, Gate Method selection affects Sweep Type: Method FFT & Sweep menu FFT Swept grayed out and rules choose FFT Video FFT grayed out and rules choose Swept LO FFT grayed out and rules choose Swept
Preset	AUTO
Backwards Compatibility SCPI	[:SENSe]:SWEep:TYPE AUTO sets sweep type Auto to On [:SENSe]:SWEep:TYPE SWP selects sweep type Swept
Initial S/W Revision	Prior to A.02.00

Help Map ID	3281
-------------	------

Auto

When in Auto, the selection of sweep type is governed by two different sets of rules, depending on whether you want to optimize for dynamic range or for speed. These rules are chosen under the **Sweep Type Rules** key.

Key Path	Sweep/Control, Sweep Setup, Sweep Type
Remote Command	[:SENSe] :SWEep:TYPE:AUTO OFF ON 0 1 [:SENSe] :SWEep:TYPE:AUTO?
Example	:SWE:TYPE:AUTO ON
Couplings	Pressing Auto Couple always sets Sweep Type to Auto.
Preset	ON
State Saved	Saved in instrument state
Initial S/W Revision	Prior to A.02.00
Help Map ID	3282

Swept

Manually selects swept analysis, so it cannot change automatically to FFT.

Key Path	Sweep/Control, Sweep Setup, Sweep Type
Example	SWE:TYPE SWE
Dependencies	Grayed out while in Gated FFT (meaning Gate is ON and Gate Method is FFT). If this key is selected, the gate method Gated FFT is grayed out.
Couplings	This selection is chosen automatically if any of the CISPR detectors is chosen for any active trace, in which case the FFT Sweep Type selection is also grayed out.
State Saved	Saved in instrument state
Readback	Swept
Initial S/W Revision	Prior to A.02.00
Modified at S/W Revision	A.02.00
Help Map ID	3283

FFT

Manually selects FFT analysis, so it cannot change automatically to Swept.

Key Path	Sweep/Control, Sweep Setup, Sweep Type
----------	--

Common Measurement Functions 1

Example	SWE:TYPE FFT
Dependencies	<p>When a CISPR detector (Quasi Peak, EMI Average, RMS Average) is selected for any active trace, the FFT key is grayed out.</p> <p>If Sweep Type is manually selected to be FFT, the CISPR detectors are all grayed out.</p> <p>Grayed out while in Gated LO (meaning Gate is ON and Gate Method is LO).</p> <p>Grayed out while in Gated Video (meaning Gate is ON and Gate Method is Video).</p> <p>If this key is selected, all of the gate Methods except Gated FFT are grayed out.</p> <p>If Manual FFT is selected, the Signal ID key is grayed out.</p> <p>When Signal ID is on, Manual FFT is grayed out.</p>
Couplings	For both the dynamic range case and the speed case, swept is chosen whenever any form of Signal ID is on.
State Saved	Saved in instrument state
Readback	FFT
Initial S/W Revision	Prior to A.02.00
Help Map ID	3284

Sweep Type Rules

Selects which set of rules are used for automatically choosing the Sweep Type when Sweep Type is in Auto.

Key Path	Sweep/Control, Sweep Setup
Remote Command	<pre>[:SENSe] :SWEep:TYPE:AUTO:RULEs SPEed DRANge</pre> <pre>[:SENSe] :SWEep:TYPE:AUTO:RULEs?</pre>
Dependencies	In Zero Span, this key is irrelevant and cannot be accessed (because the whole Sweep Setup menu is grayed out in Zero Span), however its settings can be changed remotely with no error indication.
Preset	DRANge
State Saved	Saved in instrument state
Initial S/W Revision	Prior to A.02.00
Help Map ID	3285

Auto

This selection is automatically chosen when Auto Couple is pressed. When in Auto, the Sweep Type Rules are set to Best Dynamic Range. It seems like a very simple Auto function but the use of this construct allows a consistent

statement about what the Auto Couple key does.

Key Path	Sweep/Control, Sweep Setup, Sweep Type Rules
Remote Command	[:SENSE] :SWEep:TYPE:AUTO:RULEs:AUTO[:STATe] OFF ON 0 1 [:SENSE] :SWEep:TYPE:AUTO:RULEs:AUTO[:STATe] ?
Example	:SWE:TYPE:AUTO:RUL:AUTO ON
Couplings	Pressing Auto Couple always sets Sweep Type Rules to Auto.
Preset	ON
State Saved	Saved in instrument state
Initial S/W Revision	Prior to A.02.00
Help Map ID	3286

Best Dynamic Range

This selection tells the test set to choose between swept and FFT analysis with the primary goal of optimizing dynamic range. If the dynamic range is very close between swept and FFT, then it chooses the faster one. This auto selection also depends on RBW Type.

In determining the Swept or FFT setting, the auto rules use the following approach:

If the RBW Filter Type is Gaussian use the RBW for the Normal Filter BW and if that RBW > 210 Hz, use swept; for RBW <= 210 Hz, use FFT

If the RBW Filter Type is Flat Top, use the same algorithm but use 420 Hz instead of 210 Hz for the transition point between Swept and FFT

If any of the CISPR detectors is chosen for any active trace, always use Swept.

Key Path	Sweep/Control, Sweep Setup, Sweep Type Rules
Example	SWE:TYPE:AUTO:RUL DRAN sets the auto rules to dynamic range.
Couplings	Directly selecting this setting sets AUTO to OFF.
Readback	Dynamic Range
Initial S/W Revision	Prior to A.02.00
Help Map ID	3287

Best Speed

This selection tells the test set to choose between FFT or swept analysis based on the fastest test set speed.

Key Path	Sweep/Control, Sweep Setup, Sweep Type Rules
Example	SWE:TYPE:AUTO:RUL SPE sets the rules for the auto mode to speed
Couplings	Directly selecting this setting sets AUTO to OFF.
Readback	Speed.

Common Measurement Functions 1

Initial S/W Revision	Prior to A.02.00
Help Map ID	3288

FFT Width

This menu displays and controls the width of the FFT's performed while in FFT mode. The "FFT width" is the range of frequencies being looked at by the FFT, sometimes referred to as the "chunk width" -- it is not the resolution bandwidth used when performing the FFT.

It is important to understand that this function does not directly set the FFT width, it sets the limit on the FFT Width. The actual FFT width used is determined by several other factors including the Span you have set. Usually the instrument picks the optimal FFT Width based on the current setup; but on occasion you may wish to limit the FFT Width to be narrower than that which the instrument would have set.

NOTE This function does not allow you to widen the FFT Width beyond that which the test set might have set; it only allows you to narrow it. You might do this to improve the dynamic range of the measurement or eliminate nearby spurs from your measurement.

Note that the **FFT Width** setting will have no effect unless in an FFT sweep.

See ["More Information" on page 1649](#)

Remote Command	<code>[:SENSE] :SWEep:FFT:WIDTh <real></code> <code>[:SENSE] :SWEep:FFT:WIDTh?</code>
Example	SWE:FFT:WIDTh 167 kHz sets this function to "<167.4 kHz"
Initial S/W Revision	Prior to A.02.00
Key Path	Sweep/Control, Sweep Setup
Notes	The parameter is in units of frequency. For values sent from SCPI, the test set chooses the smallest value that is at least as great as the requested value. Examples: Parameter 3.99 kHz is sent over SCPI. Test set chooses 4.01 kHz Parameter 4.02 kHz is sent over SCPI. Test set chooses 28.81 kHz Parameter 8 MHz is sent over SCPI. Test set chooses 10 MHz
Dependencies	In some models, the analog prefilters are not provided. In these models the FFT Width function is always in Auto . The FFT Width key is blanked in these models, and the SCPI commands are accepted without error but have no effect. In Zero Span, this key is irrelevant and cannot be accessed (because the whole Sweep Setup menu is grayed out in Zero Span). However, its settings can be changed remotely with no error indication.

Couplings	The FFT Width affects the ADC Dither function (see Meas Setup key) and the point at which the instrument switches from Swept to FFT acquisition.
Preset	The Preset is Auto, but Preset will also pick Best Dynamic Range and hence this function is set to ~Maximum
State Saved	Saved in instrument state
Min	4.01 kHz
Max	The maximum available FFT width is dependent on the IF Bandwidth option. For Option B10 the maximum available width is 10 MHz; for Option B25 it is 25 MHz, and for Option B40 it is 40 MHz.
Backwards Compatibility SCPI	[:SENSE]:SWEep:FFT:SPAN:RATio <integer> [:SENSE]:SWEep:FFT:SPAN:RATio? The behavior of the test set when it receives this command is to compute the “intended segment width” by dividing the Span by the FFTs/Span parameter, then converting this intended width to an actual width by using the largest available FFT Width that is still less than the intended segment width. The “Span” used in this computation is whatever the Span is currently set to, whether a sweep has been taken at that Span or not.
Modified at S/W Revision	A.04.00
Help Map ID	3289

Key Path	Sweep/Control, Sweep Setup
Remote Command	[:SENSE] :SWEep:FFT:WIDTh:AUTO OFF ON 0 1 [:SENSE] :SWEep:FFT:WIDTh:AUTO?
Example	:SWE:FFT:WIDT:AUTO ON
Couplings	Pressing Auto Couple always sets FFT Width to Auto.
Preset	ON
State Saved	Saved in instrument state
Initial S/W Revision	Prior to A.02.00
Help Map ID	0

More Information

An FFT measurement can only be performed over a limited span known as the “FFT segment”. Several segments may need to be combined to measure the entire span. For advanced FFT control in the X-Series, you have direct control over the segment width using the **FFT Width** control. Generally, in automatic operation, the X-Series sets the segment width to be as wide as possible, as this results in the fastest measurements.

However, in order to increase dynamic range, most X-series models provide a set of analog prefilters that precede the ADC. Unlike swept measurements, which pass the signal through a bandpass before the ADC, FFT measurements present the full signal bandwidth to the ADC, making them more susceptible

Common Measurement Functions 1

to overload, and requiring a lower signal level. The prefilters act to alleviate this phenomenon - they allow the signal level at the ADC to be higher while still avoiding an ADC overload, by eliminating signal power outside the bandwidth of interest, which in turn improves dynamic range.

Although narrowing the segment width can allow higher dynamic ranges some cases, this comes at the expense of losing some of the speed advantages of the FFT, because narrower segments require more acquisitions and proportionately more processing overhead.

However, the advantages of narrow segments can be significant. For example, in pulsed-RF measurements such as radar, it is often possible to make high dynamic range measurements with signal levels approaching the compression threshold of the test set in swept spans (well over 0 dBm), while resolving the spectral components to levels below the maximum IF drive level (about -8 dBm at the input mixer). But FFT processing experiences overloads at the maximum IF drive level even if the RBW is small enough that no single spectral component exceeds the maximum IF drive level. If you reduce the width of an FFT, an analog filter is placed before the ADC that is about 1.3 times as wide as the FFT segment width. This spreads out the pulsed RF in time and reduces the maximum signal level seen by the ADC. Therefore, the input attenuation can be reduced and the dynamic range increased without overloading the ADC.

Further improvement in dynamic range is possible by changing the **FFT IF Gain** (in the **Meas Setup** menu of many measurements). If the segments are reduced in width, **FFT IF Gain** can be set to High, improving dynamic range.

Depending on what IF Bandwidth option you have ordered, there can be up to three different IF paths available in FFT sweeps, as seen in the diagram below:

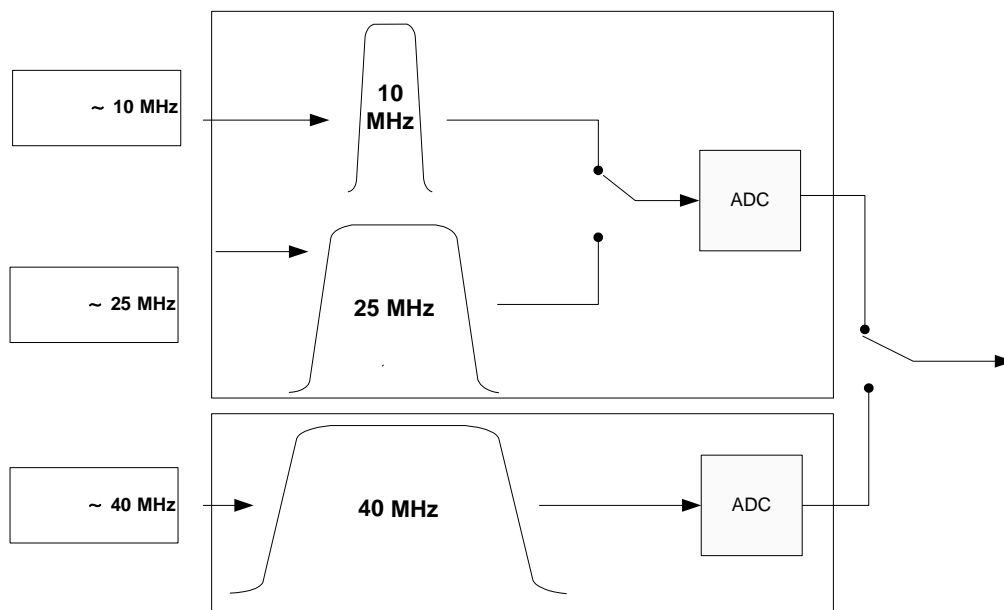

The 10 MHz path is always used for Swept sweeps. It is always used for FFT sweeps as well, unless the user specifies ~25 MHz in which case the 25 MHz path is used for FFT sweeps, or ~40 MHz, in which case the 40 MHz path is used for FFT sweeps. Note that, although each of these keys picks the specified path, the test set may choose an FFT width less than the full IF width, in order to optimize speed, trading off acquisition time versus processing time.

Pause/Resume

Pauses a measurement after the current data acquisition is complete.

When Paused, the label on the key changes to Resume. Pressing the Resume key resumes the measurement at the point where it was paused. When Paused, pressing **Restart**, **Single**, or **Cont** does a Resume.

Key Path	Sweep/Control
Remote Command	:INITiate:PAUSE
Dependencies	Grayed out in Measurements that do not support Pausing. Blanked in Modes that do not support Pausing.
Initial S/W Revision	Prior to A.02.00
Help Map ID	3290

Key Path	Sweep/Control
Remote Command	:INITiate:RESume
Dependencies	Grayed out in Measurements that do not support Pausing. Blanked in Modes that do not support Pausing.
Initial S/W Revision	Prior to A.02.00
Help Map ID	3291

Gate

Accesses a menu that enables you to control the gating function. The Gate functionality is used to view signals best viewed by qualifying them with other events.

Gate setup parameters are the same for all measurements – they do not change as you change measurements. Settings like these are called “Meas Global” and are unaffected by Meas Preset.

NOTE Sweep Time autocoupling rules and annotation are changed by Gate being on.

Key Path	Sweep/Control
Scope	Meas Global
Readback	The state and method of Gate, as [Off, LO] or [On, Video]. Note that for measurements that only support gated LO, the method is nonetheless read back, but always as LO.
Initial S/W Revision	Prior to A.02.00
Help Map ID	3292

Common Measurement Functions 1

Gate On/Off

Turns the gate function on and off.

When the Gate Function is on, the selected Gate Method is used along with the gate settings and the signal at the gate source to control the sweep and video system with the gate signal. Not all measurements allow every type of Gate Methods.

When Gate is on, the annunciation in the measurement bar reflects that it is on and what method is used, as seen in the following "Gate: LO" annunciator graphic.

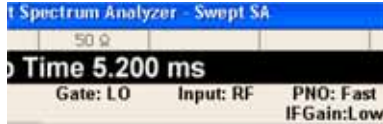

Key Path	Sweep/Control, Gate
Remote Command	[:SENSE] :SWEep:EGATE [:STATe] OFF ON 0 1 [:SENSE] :SWEep:EGATE [:STATe] ?
Example	SWE:EGAT ON SWE:EGAT ?
Dependencies	The function is unavailable (grayed out) and Off when: Gate Method is LO or Video and FFT Sweep Type is manually selected. Gate Method is FFT and Swept Sweep Type is manually selected. Marker Count is ON.
Couplings	When Meas Method is RBW or FAST, this function is unavailable and the key is grayed out. Whenever Gate is on, Meas Method, RBW or FAST is unavailable and keys for those are grayed out. When Gate is on, Offset Res BW and Offset Video BW are ignored (if you set these values) and the measurement works as if all Offset Res BW and all Offset Video BW are coupled with the Res BW and the Video BW under the BW menu. When Gate is on, the Offset BW key in the Offset/Limit menu is grayed out.
Preset	Off
State Saved	Saved in instrument state
Range	On Off
Backwards Compatibility SCPI	[:SENSE] :SWEep:TIME:GATE [:STATe]
Initial S/W Revision	Prior to A.02.00
Help Map ID	3293

Gate View On/Off

Turning on Gate View shows the split-screen Gate View. In these measurements, when the Gate View is on, the regular view of the current measurement traces and results are reduced vertically to about 70% of the regular height. The Zero Span window, showing the positions of the Gate, is shown between the Measurement Bar and the reduced measurement window. By reducing the height of the measurement window, some of the annotation on the Data Display may not fit and is not shown.

Key Path	Sweep/Control, Gate
Remote Command	[:SENSe] :SWEep:EGATe:VIEW ON OFF 1 0 [:SENSe] :SWEep:EGATe:VIEW?
Example	SWE:EGAT:VIEW ON turns on the gate view.
Dependencies	When you turn Gate View on, the lower window takes on the current state of the instrument. Upon leaving Gate View, the instrument takes on the state of the lower window. When you turn Gate View on, the upper window Sweep Time is set to the gate view sweep time.
Couplings	When Gate View is turned on, the sweep time used is the gate view sweep time. This is set according to the rules in “Gate View Sweep Time” on page 1655 . <ul style="list-style-type: none"> • When Gate View is turned off, Sweep Time is set to the normal measurement sweep time. • If Gate View is on and Gate is off, then turning on Gate turns off Gate View.
Preset	OFF
State Saved	Saved in instrument state
Range	On Off
Initial S/W Revision	Prior to A.02.00
Help Map ID	3810

A sample of the Gate View screen is shown in the following graphic. This example is for the ACP measurement:

Common Measurement Functions 1

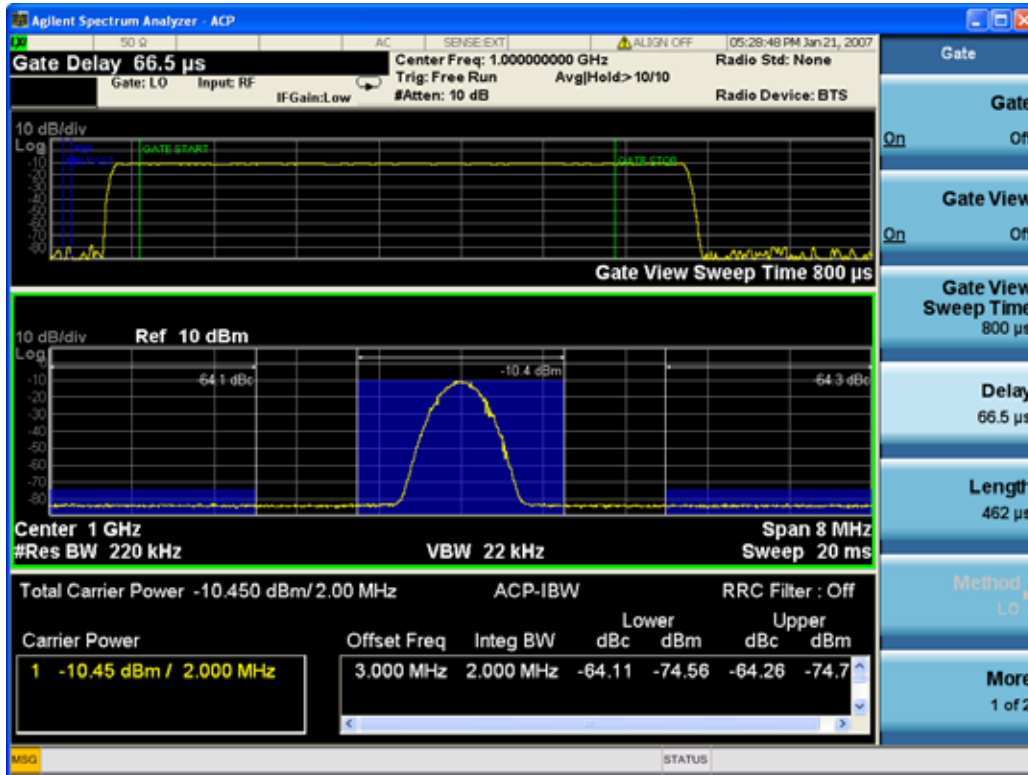

Turning Gate View off returns the test set to the Normal measurement view.

The **Gate View** window is triggered from the Gate Source, with zero trigger delay. Also, when updating the **Gate View** window, the Gate itself must not operate. So it is internally shut off while the gate view window is being updated. This means that the Gate is internally shut off whenever the gate view window is displayed. The measurement bar and keys continue to show the Trigger source for the main sweep window and give no indication that the Gate is shut off or that the Gate View window is triggered from the Gate Source.

When in **Gate View**, vertical lines are displayed in the Gate View window as follows:

- Green lines are displayed at the gate edges as follows: in Edge Gate, a line is shown for Delay and one for the end of the Gate period (defined by Length, even in FFT. In Level Gate a line is shown only for Delay. You can adjust the position of the green lines by adjusting the gate length and the gate delay. These lines update in the Gate View window as the active function changes, even if the window is not being updated. In Gated LO and Gated Video, these lines are positioned relative to the delay reference line (not relative to 0 time). In Gated FFT, their location is relative to the left edge of the screen.
- A blue line is displayed showing the delay reference, that is, the reference point for the Gate Delay within the Zero Span window. The blue line represents where (in time) the effective location of the gate start would be if the gate were programmed to zero delay.
- The second blue line is labeled "MIN FAST" as shown in the figure above because it represents the minimum Gate Delay for fast Gated LO operation. This line is only displayed in Gated LO. You cannot scroll (knob) or decrement (down key) the Gate Delay to less than that represented by the position of this line, it can only be set below this position manually, although once there it can be moved freely with the knob while below the line.

- A yellow line in the Gated Video case only, is displayed at $Blength$, where $Blength$ is the display point (bucket) length for the swept trace, which is given by the sweep time for that trace divided by number of Points – 1. So it is referenced to 0 time, not to the delay reference. This line is labeled NEXT PT (it is not shown in the figure above because the figure above is for Gated LO). The yellow line represents the edge of a display point (bucket). Normally in Gated Video, the bucket length must be selected so that it exceeds the off time of the burst. There is another way to use the test set in Gated Video measurements, and that is to set the bucket width much shorter than the off time of the burst. Then use the Max Hold trace function to fill in "missing" buckets more slowly. This allows you to see some of the patterns of the Gated Video results earlier, though seeing a completely filled-in spectrum later.

Gate View Sweep Time

Controls the sweep time in the Gate View window. To provide an optimal view of the gate signal, the test set initializes Gate View Sweep Time based on the current settings of Gate Delay and Gate Length.

Key Path	Sweep/Control, Gate
Remote Command	[:SENSe] :SWEep:EGATe:TIME <time> [:SENSe] :SWEep:EGATe:TIME?
Example	SWE:EGAT:TIME 500 ms
Dependencies	Gate View Sweep Time is initialized: On Preset (after initializing delay and length). Every time the Gate Method is set/changed. 1. Compute the location of the "gate stop" line, which you know is at time $t = t_{min} + GateDelay + GateLength$.
Preset	519.3 μ s GSM/EDGE: 1 ms
State Saved	Saved in instrument state
Min	1 μ s
Max	6000 s
Initial S/W Revision	Prior to A.02.00
Help Map ID	3305

Gate Delay

Controls the length of time from the time the gate condition goes True until the gate is turned on.

Key Path	Sweep/Control, Gate
Remote Command	[:SENSe] :SWEep:EGATe:DELAy <time> [:SENSe] :SWEep:EGATe:DELAy?

Common Measurement Functions 1

Example	SWE:EGAT:DELay 500ms SWE:EGAT:DELay?
Notes	Units of time are required or no units; otherwise an invalid suffix error is generated. See error -131.
Preset	57.7 us GSM/EDGE: 600 us
State Saved	Saved in instrument state
Min	0.0 us
Max	100 s
Backwards Compatibility SCPI	[:SENSe]:SWEep:TIME:GATE:DELay
Initial S/W Revision	Prior to A.02.00
Help Map ID	3298

Gate Length

Controls the length of time that the gate is on after it opens.

Key Path	Sweep/Control, Gate
Remote Command	[:SENSe]:SWEep:EGATe:LENGth <time> [:SENSe]:SWEep:EGATe:LENGth?
Example	SWE:EGAT:LENG 1 SWE:EGAT:LENG?
Notes	Units of time are required or no units; otherwise an invalid suffix is generated.
Dependencies	<p>Grayed out when Gate Method is set to FFT in which case the label changes to that shown below.</p> <div style="border: 1px solid gray; padding: 5px; display: inline-block;"> <p>Gate Length (=1.83/RBW) 2.8 ms</p> </div> <p style="text-align: right; margin-right: 20px;"><small>vsd 39-1</small></p> <p>The key is also grayed out if Gate Control = Level.</p>
Preset	461.6 us GSM/EDGE: 200 us
State Saved	Saved in instrument state
Min	100 ns
Max	5 s
Backwards Compatibility SCPI	[:SENSe]:SWEep:TIME:GATE:LENGth

Initial S/W Revision	Prior to A.02.00
Help Map ID	3299

Method

This lets you choose one of the three different types of gating.

Not all types of gating are available for all measurements.

Key Path	Sweep/Control, Gate
Remote Command	[:SENSe] :SWEep:EGATe:METhod LO VIDeo FFT [:SENSe] :SWEep:EGATe:METhod?
Example	SWE:EGAT:METh FFT
Preset	LO
State Saved	Saved in instrument state
Initial S/W Revision	Prior to A.02.00
Help Map ID	3300

LO

When Gate is set to On, the LO sweeps whenever the gate conditions as specified in the Gate menu are satisfied by the signal at the Gate Source.

This form of gating is more sophisticated, and results in faster measurements. With Gated LO, the test set only sweeps while the gate conditions are satisfied. This means that a sweep could take place over several gate events. It would start when the gate signal goes true and stop when it goes false, and then continue when it goes true again. But since the LO is sweeping as long as the gate conditions are satisfied, the sweep typically finishes much more quickly than with Gated Video.

When in zero span, there is no actual sweep performed. But data is only taken while the gate conditions are satisfied. So even though there is no sweep, the gate settings will impact when data is acquired.

Key Path	Sweep/Control, Gate, Method
Dependencies	Key is unavailable when Gate is On and FFT Sweep Type manually selected. When selected, Sweep Type is forced to Swept and the FFT key in Sweep Type is grayed out.
Readback	LO
Initial S/W Revision	Prior to A.02.00
Help Map ID	3301

Video

When Gate is set to On, the video signal is allowed to pass through whenever the gate conditions as specified in the Gate menu are satisfied by the signal at the Gate Source.

Common Measurement Functions 1

This form of gating may be thought of as a simple switch, which connects the signal to the input of the test set. When the gate conditions are satisfied, the switch is closed, and when the gate conditions are not satisfied, the switch is open. So we only look at the signal while the gate conditions are satisfied.

With this type of gating, you usually set the test set to sweep very slowly. In fact, a general rule is to sweep slowly enough that the gate is guaranteed to be closed at least once per data measurement interval (bucket). Then if the peak detector is used, each bucket will represent the peak signal as it looks with the gate closed.

Key Path	Sweep/Control, Gate, Method
Dependencies	Key is unavailable when Gate is On and FFT Sweep Type manually selected. When selected, Sweep Type is forced to Swept and the FFT key in Sweep Type is grayed out
Readback	Video
Initial S/W Revision	Prior to A.02.00
Help Map ID	3302

FFT

When Gate is set to On, an FFT is performed whenever the gate conditions as specified in the Gate menu are satisfied by the signal at the Gate Source. This is an FFT measurement which begins when the gate conditions are satisfied. Since the time period of an FFT is approximately $1.83/\text{RBW}$, you get a measurement that starts under predefined conditions and takes place over a predefined period. So, in essence, this is a gated measurement. You have limited control over the gate length but it works in FFT sweeps, which the other two methods do not.

Gated FFT cannot be done in zero span since the instrument is not sweeping. So in zero span the Gated LO method is used. Data is still only taken while the gate conditions are satisfied, so the gate settings do impact when data is acquired.

The Gate Length is $1.83/\text{RBW}$.

This is a convenient way to make a triggered FFT measurement under control of an external gating signal.

Key Path	Sweep/Control, Gate
Dependencies	Key is unavailable when Gate is On and Swept Sweep Type manually selected. Key is unavailable when gate Control is set to Level. When selected, Sweep Type is forced to FFT and the Swept key in Sweep Type is grayed out Forces Gate Length to $1.83/\text{RBW}$
Readback	FFT
Initial S/W Revision	Prior to A.02.00
Help Map ID	3303

Gate Source

The menus under the **Gate Source** key follow the same pattern as those under the **Trigger key**, with the exception that neither **Free Run** nor **Video** are available as Gate Source selections. Any changes to the

settings in the setup menus under each Gate Source selection key (for example: **Trigger Level**) also affect the settings under the Trigger menu keys. Note that the selected Trigger Source does not have to match the Gate Source.

Key Path	Sweep/Control, Gate
Remote Command	[:SENSe] :SWEep:EGATe:SOURce EXTernal1 EXTernal2 LINE FRAME RFBurst [:SENSe] :SWEep:EGATe:SOURce?
Dependencies	In some models, there is no second External input. In these models, the External 2 key is blanked and the EXTernal2 parameter will generate a “Hardware missing; Not available for this model number” error
Preset	EXTernal 1 GSM/EDGE: FRAME
Initial S/W Revision	Prior to A.02.00
Modified at S/W Revision	A.03.00
Help Map ID	3304

Control Edge/Level

Sets the method of controlling the gating function from the gating signal.

Edge

In Edge triggering, the gate opens (after the Delay) on the selected edge (for example, positive) of the gate signal and closes on the alternate edge (for example, negative).

Level

In Level triggering, the gate opens (after the Delay) when the gate signal has achieved a certain level and stays open as long as that level is maintained.

Key Path	Sweep/Control, Gate
Remote Command	[:SENSe] :SWEep:EGATe:CONTRol EDGE LEVel [:SENSe] :SWEep:EGATe:CONTRol?
Example	SWE:EGAT:CONT EDGE
Dependencies	If the Gate Method is FFT the Control key is grayed out and Edge is selected. If the Gate Source is TV, Frame or Line, the Control key is grayed out and Edge is selected.
Preset	EDGE
State Saved	Saved in instrument state
Backwards Compatibility SCPI	[:SENSe]:SWEep:TIME:GATE:TYPE
Initial S/W Revision	Prior to A.02.00

Gate Holdoff

Lets you increase or decrease the wait time after a gate event ends before the test set responds to the next gate signal.

After any Gate event finishes, the test set must wait for the sweep system to settle before it can respond to another Gate signal. The test set calculates a "wait time," taking into account a number of factors, including RBW and Phase Noise Optimization settings. The goal is to achieve the same accuracy when gated as in ungated operation. The figure below illustrates this concept:

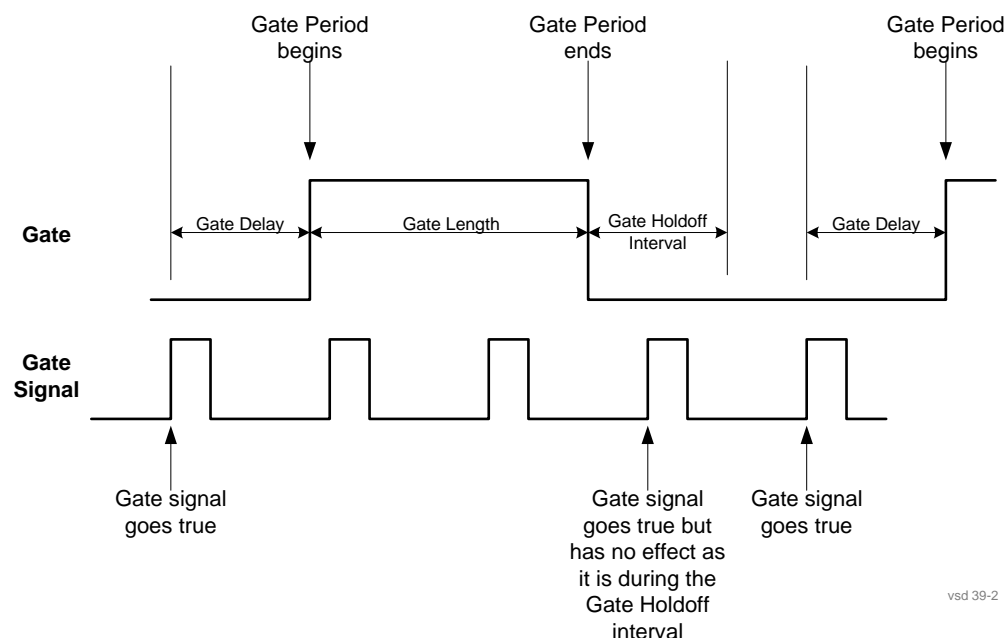

When Gate Holdoff is in Auto, the wait time calculated by the test set is used. When Gate Time is in Manual, the user may adjust the wait time, usually decreasing it in order to achieve greater speed, but at the risk of decreasing accuracy.

When the **Method** key is set to **Video** or **FFT**, the **Gate Holdoff** function has no effect.

In measurements that do not support Auto, the value shown when Auto is selected is “---” and the manually set holdoff is returned to a query.

Key Path	Sweep/Control, Gate
Remote Command	<pre>[:SENSe] :SWEp:EGATe:HOLDoff <time> [:SENSe] :SWEp:EGATe:HOLDoff? [:SENSe] :SWEp:EGATe:HOLDoff:AUTO OFF ON 0 1 [:SENSe] :SWEp:EGATe:HOLDoff:AUTO?</pre>

Example	SWE:EGAT:HOLD 0.0002 SWE:EGAT:HOLD? SWE:EGAT:HOLD:AUTO ON SWE:EGAT:HOLD:AUTO?
Couplings	<p>When Gate Holdoff is Auto, the Gate Holdoff key shows the value calculated by the test set for the wait time.</p> <p>Pressing the Gate Holdoff key while it is in Auto and not selected, causes the key to become selected and allows the user to adjust the value. If the value is adjusted, the setting changes to Man.</p> <p>Pressing the Gate Holdoff key, while it is in Auto and selected, does not change the value of Gate Holdoff, but causes the setting to change to Man. Now the user can adjust the value.</p> <p>Pressing the key while it is in Man and selected, cause the value to change back to Auto.</p> <p>Pressing the key while it is in Man and not selected, causes the key to become selected and allows the user to adjust the value.</p> <p>When Method is set to Video or FFT, the Gate Holdoff function has no effect.</p>
Preset	Auto Auto/On
State Saved	Saved in instrument state
Min	1 μsec
Max	1 sec
Initial S/W Revision	Prior to A.02.00
Help Map ID	3567

Gate Delay Compensation

This function allows you to select an RBW-dependent value by which to adjust the gate delay, to compensate for changes in the delay caused by RBW effects.

You can select between uncompensated operation and two types of compensation, **Delay Until RBW Settled** and **Compensate for RBW Group Delay**.

See “[More Information](#)” on page 1662

Key Path	Sweep/Control, Gate
Scope	Meas Global
Remote Command	<pre>[:SENSe] :SWEep:EGATe:DElay:COMPensation:TYPE OFF SETTled GDElay [:SENSe] :SWEep:EGATe:DElay:COMPensation:TYPE?</pre>

Common Measurement Functions 1

Example	SWE:EGAT:DEL:COMP:TYPE SETT SWE:EGAT:DEL:COMP:TYPE?
Notes	Although this function is Meas Global, there are some measurements that do not support this function. In those measurements the operation is Uncompensated. Going into one of those measurements does not change the Meas Global selection; it simply displays the grayed-out menu key with “Uncompensated” showing as the selection and the SCPI command is still accepted. If Gate Delay Compensation is not supported at all within a particular mode, the key is not displayed, and if the SCPI command is sent while in a measurement within that mode, an “Undefined Header” error is generated.
Preset	Delay Until RBW Settled
State Saved	Saved in instrument state
Range	Uncompensated Delay Until RBW Settled Compensate for RBW Group Delay
Readback text	Uncompensated Settled Group Delay
Initial S/W Revision	Prior to A.02.00
Help Map ID	29882

More Information

Selecting **Uncompensated** means that the actual gate delay is as you sets it.

Selecting **Delay Until RBW Settled** causes the gate delay to be increased above the user setting by an amount equal to 3.06/RBW. This compensated delay causes the GATE START and GATE STOP lines on the display to move by the compensation amount, and the actual hardware gate delay to be increased by the same amount. All the other gate lines (for example, MIN FAST) are unaffected. If the RBW subsequently changes, the compensation is readjusted for the new RBW. The value shown on the **Gate Delay** key does NOT change.

Delay Until RBW Settled allows excellent measurements of gated signals, by allowing the IF to settle following any transient that affects the burst. Excellent measurements also require that the analysis region not extend into the region affected by the falling edge of the burst. Thus, excellent measurements can only be made over a width that declines with narrowing RBWs. Therefore, for general purpose compensation, you will still want to change the gate length with changes in RBW even if the gate delay is compensated.

Selecting **Compensate for RBW Group Delay** causes the gate delay to be increased above the user setting by an amount equal to 1.81/RBW. This compensated delay causes the GATE START, GATE STOP lines on the display to move by the compensation amount, and the actual hardware gate delay to be increased by the same amount. All the other gate lines (for example, MIN FAST) are unaffected. If the RBW subsequently changes, the compensation is readjusted for the new RBW. The value shown on the **Gate Delay** key does NOT change. **Compensate for RBW Group Delay** also includes gate length compensation; the gate length itself is adjusted as necessary to attempt to compensate for delay effects imposed by the RBW.

Compensate for RBW Group Delay is similar to **Delay Until RBW Settled**, but compensates for the

group delay of the RBW filter, rather than the filter settling time. As the RBW gets narrow, this can allow the settling tail of the RBW to affect the beginning part of the gated measurement, and allow the beginning of the RBW settling transient to affect the end of the gated measurement. These two effects are symmetric because the RBW response is symmetric. Because the gate length is not automatically compensated, some users might find this compensation to be more intuitive than compensation for RBW settling.

Min Fast Position Query (Remote Command Only)

This command queries the position of the MIN FAST line, relative to the delay reference (REF) line. See section “Gate View On/Off” on page 1653. If this query is sent while not in gate view, the MinFast calculation is performed based on the current values of the appropriate parameters and the result is returned. Knowing this value lets you set an optimal gate delay value for the current measurement setup.

Remote Command:	[:SENSe] :SWEep :EGATe :MINFast?
Example:	SWE:EGAT:MIN?
Initial S/W Revision:	Prior to A.02.00
Help Map ID:	0

Points

Sets the number of points taken per sweep, and displayed in the traces. The current value of points is displayed parenthetically, next to the sweep time in the lower-right corner of the display. Using more points provides greater resolution; using fewer points compacts the data and decreases the time required to access a trace over the remote interface.

Increasing the number of points does not increase the sweep time; however, it can slightly impact the trace processing time and therefore the overall measurement speed. Decreasing the number of points does not decrease the sweep time, but it may speed up the measurement, depending on the other sweep settings (for example, in FFT sweeps). Fewer points will always speed up the I/O.

Due to minimum sweep rate limitations of the hardware, the minimum sweep time available to the user will increase above its normal value of 1 ms as the number of sweep points increases above 15001.

Changing the number of sweep points has several effects on the test set. The sweep time resolution will change. Trace data for all the traces is cleared and, if Sweep is in Cont, a new trace taken. If any trace is in average or hold, the averaging starts over.

When sweep points is changed, an informational message is displayed, "Sweep points changed, all traces cleared."

Key Path	Sweep
Remote Command	[:SENSe] :SWEep :POINts <integer> [:SENSe] :SWEep :POINts?
Example	SWE:POIN 5001 SWE:POIN?

Common Measurement Functions 1

Dependencies	Grayed out in measurements that do not support swept Blanked in modes that do not support swept.
Couplings	Is affected by: log sweep Whenever the number of sweep points change: All trace data is erased Any traces with Update Off will also go to Display Off Sweep time is re-quantized Any limit lines that are on are updated If averaging/hold is on, averaging/hold starts over
Preset	1001
State Saved	Saved in instrument state
Min	1
Max	40001
Initial S/W Revision	Prior to A.02.00
Modified at S/W Revision	A.02.00
Help Map ID	3306

Abort (Remote Command Only)

This command is used to stop the current measurement. It aborts the current measurement as quickly as possible, resets the sweep and trigger systems, and puts the measurement into an "idle" state. If the test set is in the process of aligning when ABORT is sent, the alignment finishes before the abort function is performed. So ABORT does not abort an alignment.

If the test set is set for Continuous measurement, it sets up the measurement and initiates a new data measurement sequence with a new data acquisition (sweep) taken once the trigger condition is met.

If the test set is set for Single measurement, it remains in the "idle" state until an :INIT:IMM command is received.

Remote Command:	:ABORT
Example:	:ABOR
Notes:	If :INITiate:CONTinuous is ON, then a new continuous measurement will start immediately; with sweep (data acquisition) occurring once the trigger condition has been met. If :INITiate:CONTinuous is OFF, then :INITiate:IMMEDIATE is used to start a single measurement; with sweep (data acquisition) occurring once the trigger condition has been met.
Dependencies:	For continuous measurement, ABORT is equivalent to the Restart key. Not all measurements support the abort command.

Status Bits/OPC dependencies:	The STATUS:OPERation register bits 0 through 8 are cleared. The STATUS:QUESTionable register bit 9 (INTEGRity sum) is cleared. Since all the bits that feed into OPC are cleared by the ABORt, the ABORt will cause the *OPC query to return true.
Initial S/W Revision:	Prior to A.02.00
Help Map ID:	3310

Trace/Detector

The **Trace/Detector** menu lets you control the acquisition, display, storage, detection and manipulation of trace data for the six available traces. The first page of this menu contains a selection of the trace type (**Clear Write, Trace Average, Max Hold, Min Hold**) for the selected trace. Those choices are described here.

A trace is a series of data points, each having an x and a y value. The x value is usually frequency (or time) and the y value is amplitude. Each data point is referred to as a trace point. In any given trace, trace point 0 is the first point, and trace point (sweep_points – 1) is the last. For example, in a 1001 point trace, the first point is 0 and the last is 1000. Another term sometimes used to describe traces is bucket. A bucket is the frequency span before and after the trace point equal to the point spacing. The y value is measured across (during) this bucket.

For more information see:

[“Trace Update Indicator” on page 1666](#)

[“Trace Annotation” on page 1667](#)

Key Path	Trace/Detector
Remote Command	:TRACe [1] 2 3 4 5 6 :TYPE WRITe AVERAge MAXHold MINHold :TRACe [1] 2 3 4 5 6 :TYPE?
Notes	WRITe = Clear Write AVERAge = Trace Average MAXHold = Maximum Hold MINHold = Minimum Hold
Couplings	Sending a trace command does not cause the specified trace to become selected. Selecting a trace type (pressing any of the four keys or sending a TRAC:TYPE command) puts Update in On and Display in On , even if that trace type was already selected.

Common Measurement Functions 1

Preset	Write. During normal operation of the instrument (that is, other than at power up), after a mode preset is performed, all active traces are cleared. This is so their domains and initial x values will match the current X-axis of the test set. Inactive traces are not cleared after a preset, so a trace which is in Update = On before a preset, and in Update = Off after the preset, will still have the data that it had before the preset.
State Saved	The type of each trace is saved in Instrument State
Initial S/W Revision	Prior to A.02.00
Help Map ID	3311

Trace Update Indicator

Trace updates can take one of two forms:

The trace is updated in a single operation that affects all of the points in the trace at once. This happens, for example, in the case of very fast (< 200 ms) sweeps, single-chunk FFT's, and the initial math operation after a math function is set for a trace.

The trace is updated in a series of discrete steps, with measurement data being gathered between each step. This is the case for slow sweeps, multi-chunk FFT's, et cetera.

In the first case, no update indicator is required. In the second case, however, a visual indicator exists on the trace where the new data is being written, a green "caret" or ^ symbol, which moves across the bottom of the graticule showing the current trace point.

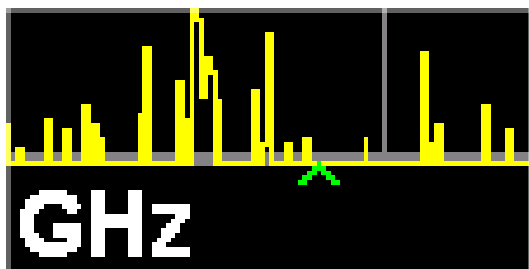

Trace Annunciator Panel

The trace annunciator panel appears on the right hand side of the Meas Bar. Here is an explanation of the fields in this panel:



On the line labeled "TRACE", each trace number is shown, in the trace color. A green box is drawn around the currently selected trace

Below each trace number, on the line labeled “TYPE”, is a letter signifying the trace type for that trace number, where

W = Clear Write
A = Trace Average
M = Max Hold
m = Min Hold

If the letter is white it means the trace is being updated (**Update = On**); if the letter is dimmed, it means the trace is not being updated (**Update = Off**). A strike through (for example, W) indicates that the trace is blanked (**Display = Off**). Note that it is possible for a trace to be updating and blanked, which is useful if the trace is a trace math component.

The third line, labeled “DET”, shows the detector type for each trace, or, if trace math is on for that trace, it shows an “f” (for “math function”). It is not always possible to have a unique detector for each trace, but the test set hardware provides the maximum flexibility of detector selection in order to maintain the highest accuracy. The letters used for this readout are:

N = Normal
A = Average
P = peak
p = negative peak
S = Sample
Q = Quasi Peak
E = EMI Average
R = RMS Average
f = math function

If the DET letter is green it means the detector is in Auto; if it is white it means the detector has been manually selected.

Trace Annotation

When Trace Annotation (see View/Display menu) is On, each non-blanked trace is labeled on the trace with the detector used to take it, unless a trace math function is on for that trace, in which case it is labeled with the math function.

The detector labels are:

NORM = Normal
PEAK = Peak
SAMP = Sample
NPEAK = Negative Peak
RMS = Average detector with Power Average (RMS)
LG AVG = Average detector with Log-Pwr Average
VAVG = Average detector with Voltage Average
QPEAK = Quasi Peak
EMI AVG = EMI Average

Common Measurement Functions 1

RMS AVG = RMS Average

The trace math labels are:

PDIF = Power Difference

PSUM = Power Sum

LOFF = Log Offset

LDIF = Log Difference

Select Trace

Determines which trace the type control keys will affect. Press **Trace** until the number of the desired trace is underlined.

Key Path	Trace
Preset	Trace 1
State Saved	The number of the selected trace is saved in Instrument State
Initial S/W Revision	Prior to A.02.00
Help Map ID	3314

Clear Write

In **Clear Write** type each trace update replaces the old data in the trace with new data. Pressing the **Clear Write** key for the selected trace, or sending the TRAC:TYPE WRIT command for the specified trace, sets the trace type to **Clear Write** and causes the trace to be cleared. Then a new sweep is initiated.

Because pressing **Clear Write** stops the current sweep and initiates a new one, **Trace Average**, **Max Hold** and **Min Hold** data may be interrupted in mid-sweep, and may not accurately reflect the displayed count. Therefore, when **Clear Write** is pressed for one trace, **Trace Average**, **Max Hold** and **Min Hold** must restart for all traces.

When in **Clear Write**, if a measurement-related instrument setting is changed, a new sweep is initiated but the trace is not cleared.

Key Path	Trace/Detector
Example	TRAC:TYPE WRIT
Notes	See “Trace/Detector” on page 1665 .
Couplings	Whenever you press Clear Write or send the equivalent SCPI command, Update is set to On and Display is set to On . Automatic detector selection and the VBW:RBW ratio auto rules both depend on the trace type selections
Preset	After a Preset, any trace that is in Clear Write is cleared (all trace points set to mintracevalue).
State Saved	The type for each trace is saved in Instrument State

Initial S/W Revision	Prior to A.02.00
Help Map ID	3315

Trace Average

In **Trace Average** type the test set maintains and displays an average trace, which represents the cumulative average on a point-by-point basis of the new trace data and previous averaged trace data. Details of the averaging calculations may be found under [“Average/Hold Number” on page 1511](#) and [“Average Type” on page 1512](#) in the Meas Setup Section.

See [“Trace Averaging: More Information” on page 1669](#).

Key Path	Trace/Detector
Example	TRAC2:TYPE AVER
Notes	See “Trace/Detector” on page 1665 .
Couplings	Affected by Average Type and Average/Hold Number Whenever you press Trace Average or send the equivalent SCPI command, Update is set to On and Display is set to On . Automatic detector selection and the VBW:RBW ratio auto rules both depend on the trace type selections.
Preset	after a Preset, any trace that is in Trace Average is cleared (all trace points set to mintracevalue).
State Saved	the type for each trace is saved in Instrument State
Initial S/W Revision	Prior to A.02.00
Help Map ID	3316

Trace Averaging: More Information

Pressing the **Trace Average** key (for the selected trace), or sending the TRAC:TYPE AVER command (for the specified trace), sets the trace type to **Trace Average** and causes the average to be restarted.

When in **Trace Average**, if a measurement-related instrument setting is changed, the average restarts and a new sweep is initiated but the trace is not cleared.

Restarting the average means:

The average/hold count k is set to 1, so that the next time the average trace is displayed it simply represents one trace of new data

A new sweep is initiated.

Once the new sweep starts, the trace is overwritten with current trace data as the first trace of the new average

Remember that restarting averaging also restarts **Max Hold** and **Min Hold**, as there is only one count for Trace Average and Hold.

Common Measurement Functions 1

Max Hold

In **Max Hold** type the test set maintains and displays a max hold trace, which represents the maximum data value on a point-by-point basis of the new trace data and previous trace data.

Pressing the **Max Hold** key for the selected trace, or sending the `:TRAC:TYPE MAXH` command for the specified trace, sets the trace type to **Max Hold**, causes the trace to be cleared, and causes the **Max Hold** sequence to be restarted.

When in **Max Hold**, if a measurement-related instrument setting is changed, the **Max Hold** sequence restarts and a new sweep is initiated but the trace is not cleared.

Restarting the **Max Hold** sequence means:

- The average/hold count k is set to 1, so that the next time the max hold trace is displayed it simply represents one trace of new data
- A new sweep is initiated.

Remember that restarting **Max Hold** also restarts averaging and **Min Hold**, as there is only one count for Trace Average and Hold.

Key Path	Trace/Detector
Example	TRAC4:TYPE MAXH
Notes	See “Trace/Detector” on page 1665 .
Couplings	Affected by Average Type and Average/Hold Number Whenever you press Max Hold or send the equivalent SCPI command, Update is set to On and Display is set to On . Automatic detector selection and the VBW:RBW ratio auto rules both depend on the trace type selections.
Preset	After a Preset, any trace that is in Max Hold is cleared (all trace points set to mintracevalue).
State Saved	The type for each trace is saved in Instrument State
Initial S/W Revision	Prior to A.02.00
Help Map ID	3317

Min Hold

In **Min Hold** type the test set maintains and displays a min hold trace, which represents the minimum data value on a point-point basis of the new trace data and previous trace data. Details of the count limiting behavior may be found under [“Average/Hold Number” on page 1511](#) in the Meas Setup Section.

Pressing the **Min Hold** key for the selected trace, or sending the `TRAC:TYPE MINH` command for the specified trace, sets the trace type to **Min Hold**, causes the trace to be cleared, and causes the **Min Hold** sequence to be restarted.

When in **Min Hold**, if a measurement-related instrument setting is changed, the **Min Hold** sequence restarts and a new sweep is initiated but the trace is not cleared.

Restarting the **Min Hold** sequence means:

- The average/hold count k is set to 1, so that the next time the min hold trace is displayed it simply represents one trace of new data
- A new sweep is initiated.

Remember that restarting **Min Hold** also restarts **Max Hold** and averaging, as there is only one count for Trace Average and Hold.

Key Path	Trace/Detector
Example	TRAC3:TYPE MINH
Notes	See ““Trace/Detector” on page 1665”.
Couplings	Affected by Average Type and Average/Hold Number . Whenever you press Min Hold or send the equivalent SCPI command, Update is set to On and Display is set to On . Automatic detector selection and the VBW:RBW ratio auto rules both depend on the trace type selections.
Preset	After a Preset, any trace that is in Min Hold is cleared (all trace points set to maxtracevalue).
State Saved	The type for each trace is saved in Instrument State
Initial S/W Revision	Prior to A.02.00
Help Map ID	3318

View/Blank

This key lets you set the state of the two trace variables, Update and Display. The four choices available in this 1-of-N menu are:

Trace On: Update and Display both On

View: Update Off and Display On

Blank: Update Off and Display Off

Background: Update On, Display Off (this allows a trace to be blanked and continue to update “in the background”, which was not possible in the past)

A trace with Display Off is indicated by a strikethrough thru the type letter in the trace annotation panel in the Measurement bar. A trace with Update Off is indicated by dimming the type letter in the trace annotation panel in the Measurement bar. So in the example below, Traces 3, 4, 5 and 6 have Update Off and Traces 4 and 6 have Display Off.

Common Measurement Functions 1

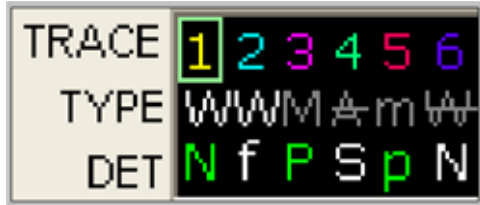

See “Trace Update State On/Off” on page 1673.

See “Trace Display State On/Off” on page 1673.

See “More Information” on page 1673.

Key Path	Trace/Detector
Notes	<p>The four states of this 1-of-N actually set two variables, Update and Display, to their four possible combinations:</p> <p>Trace On: Update and Display both On</p> <p>View: Update Off and Display On</p> <p>Blank: Update Off and Display Off</p> <p>Background: Update On, Display Off</p> <p>See tables below for detail on the SCPI to control these two variables.</p>
Couplings	<p>Selecting a trace type (Clear Write, Trace Average, Max Hold, Min Hold) for a trace (pressing the key or sending the equivalent SCPI command) puts the trace in Trace On (Update On and Display On), even if that trace type was already selected.</p> <p>Selecting a detector for a trace (pressing the key or sending a [:SENS]:DET:TRAC command) puts the trace in Trace On (Update On and Display On), even if that detector was already selected.</p> <p>Selecting a math mode other than Off for a trace (pressing the key or sending the equivalent SCPI command) puts the trace in Trace On (Update On and Display On), even if that math mode was already selected.</p> <p>Loading a trace from a file puts that trace in View regardless of the state it was in when it was saved; as does being the target of a Copy or a participant in an Exchange.</p>
Initial S/W Revision	Prior to A.02.00
Help Map ID	3319

Trace Update State On/Off

Key Path	Trace/Detector
Remote Command	:TRACe [1] 2 3 4 5 6 :UPDate [:STATe] ON OFF 0 1 :TRACe [1] 2 3 4 5 6 :UPDate [:STATe] ?
Example	TRAC2:UPD 0 Makes trace 2 inactive (stops updating)
Couplings	Whenever you set Update to On for any trace, the Display is set to On for that trace.
Preset	1 0 0 0 0 0 (On for Trace 1; Off for 2–6)
State Saved	Saved in Instrument State
Initial S/W Revision	Prior to A.02.00
Help Map ID	0

Trace Display State On/Off

Key Path	Trace/Detector
Remote Command	:TRACe [1] 2 3 4 5 6 :DISPlay [:STATe] ON OFF 0 1 :TRACe [1] 2 3 4 5 6 :DISPlay [:STATe] ?
Example	TRAC2:DISP,1 Makes trace 2 visible TRAC3:DISP,0 Blanks trace 3
Couplings	Whenever you set Update to On for any trace, the Display is set to On for that trace.
Preset	1 0 0 0 0 0 (On for Trace 1; Off for 2–6)
State Saved	Saved in Instrument State
Initial S/W Revision	Prior to A.02.00
Help Map ID	0

More Information

When a trace becomes inactive, the following things happen:

Any update from the SENSE system (detectors) immediately stops (does not wait for end of sweep)

the trace is displayed at half intensity (as long as it stays inactive)

Inactive traces display across the entire X-axis of the instrument. Their horizontal placement does not change even if X-axis settings subsequently are changed, although Y-axis settings will affect the vertical placement of data.

In most cases, inactive traces are static and unchanging; however, there are cases when an inactive trace will update, specifically:

Common Measurement Functions 1

if data is written to that trace from remote

if trace data is loaded from mass storage

if the trace is the target of a Copy or participant in an Exchange

if the trace is cleared using the Clear Trace function (below)

When a trace becomes active (Update = On), the trace is cleared, the average count is reset, and a new sweep is initiated.

Traces which are blanked (Display = off) do not display nor appear on printouts but are otherwise unaffected. They may be queried and markers may be placed on them.

Note that the action of putting a trace in Display = Off and/or Update = Off does not restart the sweep and does not restart Averaging or Hold functions for any traces.

Note also that whenever you set **Update** to **On** for any trace, **Display** is set to **On** for that trace.

Detector

Selects a detector. The detector selected is then applied to the selected trace.

For the SCPI UI, two commands are provided. One is a legacy command, which affects all traces. There is also a command which is new for the X-Series, which uses a subopcode to specify to which trace the specified detector is to be applied.

The three detectors on the second page of the Detector menu, Quasi Peak, EMI Average, and RMS Average, are referred to collectively as the “CISPR detectors” because their behaviors are specified by the CISPR 16–1–1 specification.

See “[More Information](#)” on page 1676

Key Path	Trace/Detector, Detector
Remote Command	[:SENSe] :DETECTOR:TRACe [1] 2 3 4 5 6 AVERAge NEGAtive NORMAl POSitive SAMPlE QPEak EAVERage RAVerage [:SENSe] :DETECTOR:TRACe [1] 2 3 4 5 6?
Example	DET:TRAC AVER -- Sets trace 1’s detector to average DET:TRAC1 AVER -- Sets trace 1’s detector to average DET:TRAC2 SAMP -- Sets trace 2’s detector to sample
Notes	When a detector selection is made, the menu returns to the previous menu. Selecting any CISPR detector on any active trace sets the EMI Standard to CISPR.

Notes	<p>The query returns a name that corresponds to the detector type as shown below, and indicates the setting for Trace 1.</p> <p>String ReturnedDefinition</p> <p>NORM = Normal</p> <p>AVER = Average / RMS</p> <p>POS = Positive peak</p> <p>SAMP = Sample</p> <p>NEG = Negative peak</p> <p>QPE = Quasi Peak</p> <p>EAV = EMI Average</p> <p>RAV = RMS Average</p>
Dependencies	<p>When Tune & Listen is turned on, or Demod Audio is the selected Analog Output:</p> <ul style="list-style-type: none"> all active traces are forced to use the same detector. CISPR detectors (QPD, EMI Avg, RMS Avg) are unavailable <p>CISPR detectors are grayed out when you have manually selected FFT sweep. Conversely, if any CISPR detector is selected on an active trace, the auto rules for sweep type will never select FFT, and manual FFT selection is grayed out.</p> <p>If the grayed out key is pressed, an advisory message is generated. If the equivalent SCPI command is sent, this same message is generated as part of a “-221, Settings conflict” warning.</p>
Couplings	<p>The auto detector rules depend upon marker type, averaging state and type, trace state writing mode, and trace active state.</p> <p>If the Avg Type is in Auto, and any of the CISPR detectors is selected on any active trace, the Voltage Averaging type is auto-selected.</p>
Preset	<p>Preset returns all traces to “auto”, which will result in Normal (Rosenfell) detection for all traces.</p>
State Saved	<p>Saved in State</p>
Initial S/W Revision	<p>Prior to A.02.00</p>
Modified at S/W Revision	<p>A.02.00</p>
Help Map ID	<p>3321</p>

Remote Command:	<pre>[:SENSE] :DETector [:FUNCTION] NORMAL AVERAGE POSitive SAMple NEGative QPEak EAverage EPOSitive MPOSitive RMS [:SENSe] :DETector [:FUNctIon] ?</pre>
Example:	<pre>DET AVER Sets detector to average for all traces DET:FUNC? Returns trace 1's detector setting</pre>

Common Measurement Functions 1

Notes:	<p>This is a SCPI only legacy command to preserve the classic functionality wherein all traces are affected when a detector is selected.</p> <p>The query returns a name that corresponds to the detector type as shown below, and indicates the setting for Trace 1.</p> <p>The RMS selection sets the detector type to AVERage and the Average Type to RMS. Therefore if RMS has been selected, the query will return the "AVER" string.</p> <p>The EPOS selection sets the detector type to Peak and the EMI Standard to CISPR. A query will then return POS</p> <p>The MPOS selection sets the detector type to Peak and the EMI Standard to MIL Impulse. A query will then return POS</p> <p>The RAV parameter is not included in the command because this is not a legacy detector; nonetheless, if it happens to be the detector on Trace 1 then RAV is returned.</p> <p>String ReturnedDefinition</p> <p>NORMNormal</p> <p>AVERAverage / RMS</p> <p>POSPositive peak</p> <p>SAMPSample</p> <p>NEGNegative peak</p> <p>QPEQuasi Peak</p> <p>EAVEMI Average</p> <p>RAVRMS Average</p>
Preset:	NORMal
State Saved:	Saved in State
Initial S/W Revision:	Prior to A.02.00
Modified at S/W Revision:	A.02.00
Help Map ID:	3322

More Information

The available detectors are:

The Sample detector indicates the instantaneous level of the signal at the center of the bucket represented by each display point.

The Normal detector determines the peak of CW-like signals, and it yields alternating maximums and minimums of noise-like signals. This is also referred to as Rosenfell detection.

The Average detector determines the average of the signal within the bucket. The averaging method depends upon Average Type selection (voltage, power or log scales).

The Peak detector determines the maximum of the signal within the bucket.

The Negative Peak detector determines the minimum of the signal within the bucket.

The Quasi-Peak detector is a fast-rise, slow-fall detector used in making CISPR compliant EMI measurements.

The EMI-Average detector provides a standard means to “smooth” the signal while still providing compliance to CISPR pulse response standards. It displays the average value of the amplitude envelope, rather than the average value of sample-detected amplitude, and uses an advanced algorithm to realize a lowpass filter that conforms to the latest CISPR standard.

The RMS Average detector is a frequency dependent RMS or Averaging filter, used in making CISPR compliant EMI measurements, which performs one averaging process (in the VBW hardware) on the "power" (a.k.a. RMS) scale, and another process on the voltage scale using a "meter movement simulator". This filter conforms to the 2007 revision of the CISPR 16–1–1 standard.

Because they may not find a spectral component's true peak, neither average nor sample detectors measure amplitudes of CW signals as accurately as peak or normal, but they do measure noise without the biases of peak detection.

When the Detector choice is Auto, the detector selected depends on marker functions, trace functions, average type, and the trace averaging function.

When you manually select a detector (instead of selecting Auto), that detector is used regardless of other test set settings.

Multiple Detectors

The test set always provides the requested detector on the specified trace. Depending on the detectors requested the test set can provide up to three different detectors simultaneously, within the constraints of its digital processing algorithms. Some detectors utilize more resources; the Quasi-Peak detector, for example, utilizes most of the digital IF’s resources, and the hardware in some test sets is incapable of providing another detector when Quasi-Peak is on. If the limit of system resources is exceeded, detectors on some existing traces may be forced to change. When this happens, they change to match the detector just requested, and a message is generated: “Detector <X> changed due to physical constraints”, where X might contain multiple values.

Example: User has traces 1, 2, and 3 with Peak, Average, and Negative Peak. User specifies QPD for trace 1. Traces 2 and 3 also change to QPD and we generate the message “Detector 2,3 changed due to physical constraints”. Now all three traces have the QPD.

Auto

This sets the detector for the currently selected trace to Auto. (For SCPI, the trace number is specified as a subopcode.) This will immediately apply the auto rules to determine a new detector value.

Key Path	Trace/Det, Detector
Remote Command	[:SENSE] :DETECTOR:TRACE [1] 2 3 4 5 6 :AUTO ON OFF 1 0 [:SENSE] :DETECTOR:TRACE [1] 2 3 4 5 6 :AUTO?
Example	DET:TRACE2:AUTO ON sets trace 2 detection to automatic.

Common Measurement Functions 1

Dependencies	The auto detector rules depend upon marker type, averaging state and type, trace state writing mode, and trace active state.
Couplings	Selecting AUTO, whether by pressing the key or sending the equivalent SCPI command, will turn trace math to Off for the selected/specified trace.
Preset	Auto (On) for all detectors.
State Saved	Saved in state
Initial S/W Revision	Prior to A.02.00
Help Map ID	3323

Remote Command:	[:SENSe] :DETeCTOR:AUTO ON OFF 1 0 [:SENSe] :DETeCTOR:AUTO?
Example:	DET:AUTO ON
Notes:	SCPI only. Turns AUTO on or off for ALL detectors. This is a legacy command to preserve the classic functionality wherein all traces are affected when a detector is addressed
Notes:	The query returns the Auto state of Trace 1.
Initial S/W Revision:	Prior to A.02.00
Help Map ID:	0

Normal

This sets the detector for the current selected trace to Normal (Rosenfell).

When the signal is CW-like, it displays the peak-detected level in the interval (bucket) being displayed. If the signal is noise-like (within a bucket the signal both rose and fell), it alternates displaying the max/min values. That is, an even bucket shows the peak (maximum) within a two-bucket wide interval centered on the even bucket. And an odd bucket will show the negative peak (minimum) within a two-bucket wide interval. For example, for an even bucket the two-bucket wide interval is a combination of one-half bucket to the left of the even bucket, the even bucket itself, and one-half bucket to the right of the even bucket, so the peak found is displayed in the correct relative location on screen. The odd buckets are similar.

Key Path	Trace/Det, Detector
Example	DET:TRAC3 NORM sets the detector to normal for trace 3.
Dependencies	Selecting any detector (even the currently selected detector) for a given trace turns Update and Display on for that trace. Normal detector is grayed out when the X scale is Log.

Couplings	<p>Selecting a specific detector type turns “Auto” to false for this trace (manual).</p> <p>Selecting a detector for a trace (pressing the key or sending a [:SENS]:DET:TRAC command) puts Update On and Display On for that trace, even if that detector was already selected. Note that the legacy command [:SENS]:DET[:FUNC] does NOT exhibit this behavior.</p> <p>Selecting a detector, whether by pressing the key or sending the equivalent SCPI command, will turn trace math to Off for the selected/specified trace.</p>
Initial S/W Revision	Prior to A.02.00
Help Map ID	3324

Average (Log/RMS/V)

For each bucket (interval) in the trace, Average detection displays the average of the amplitude within the bucket using one of the following averaging methods:

Log power (also known as video)

Power (also known as RMS)

Voltage envelope

To explicitly set the averaging method, use the **Meas Setup, Average Type** key. When you are using average detection with the Power method is equivalent to what is sometimes referred to as “RMS detection”. The detailed information about the different types of averaging is found in **Average Type** in the **Meas Setup** key menu.

Key Path	Trace/Det, Detector
Example	DET:TRAC3 AVER sets the detector to average for trace 3.
Notes	<p>For the specific case of a customer wanting RMS detection, they need to set the averaging type to RMS, and also select average detection for the trace:</p> <p>AVER:TYPE RMS</p> <p>DET:TRAC AVER</p>
Dependencies	Selecting any detector (even the currently selected detector) for a given trace turns Update and Display on for that trace.

Common Measurement Functions 1

Couplings	<p>Selecting a specific detector type turns “Auto” to false for this trace (manual).</p> <p>Selecting a detector for a trace (pressing the key or sending a [:SENS]:DET:TRAC command) puts Update On and Display On for that trace, even if that detector was already selected. Note that the legacy command [:SENS]:DET[:FUNC] does NOT exhibit this behavior.</p> <p>Selecting a detector, whether by pressing the key or sending the equivalent SCPI command, will turn trace math to Off for the selected/specified trace.</p> <p>The VBW filter is not used for this detector, so varying the VBW will have no effect for any traces for which this detector is selected (other than to slow down the sweep, because of the coupling to Sweep Time of VBW). If the only traces which are active are traces for which VBW does not apply (traces with Average, EMI Average, RMS Average or Quasi Peak detectors), then the VBW annotation shows “---” on the front panel, although still returns the current value of VBW to a SCPI query.</p> <p>Use of the Average detector affects the VBW setting because of its effect on the VBW/RBW coupling. See the BW section under the key ““Video BW” on page 1345”.</p>
Initial S/W Revision	Prior to A.02.00
Help Map ID	3325

Peak

For each bucket (interval) in the trace, Peak detection displays the highest amplitude within the bucket.

Peak detection is used for CW measurements and some pulsed-RF measurements. For FFT analysis, the highest amplitude across the frequency width of a bucket is displayed, even if that peak amplitude falls between samples of the spectrum computed in the FFT process.

Key Path	Trace/Det, Detector
Example	DET:TRAC2 POS sets the detector to peak for trace 2.
Couplings	<p>Selecting a specific detector type turns “Auto” to false for this trace (manual).</p> <p>Selecting a detector for a trace (pressing the key or sending a [:SENS]:DET:TRAC command) puts Update On and Display On for that trace, even if that detector was already selected. Note that the legacy command [:SENS]:DET[:FUNC] does NOT exhibit this behavior.</p> <p>Selecting a detector, whether by pressing the key or sending the equivalent SCPI command, will turn trace math to Off for the selected/specified trace.</p>
Initial S/W Revision	Prior to A.02.00
Help Map ID	3326

Sample

The sample detector displays the instantaneous level of the signal at the center of the bucket (interval) represented by each trace point.

Sample detection is good for displaying noise or noise-like signals.

Sample detection is not the best for making amplitude measurements of CW-like signals for two reasons. First, the peak response to a signal can occur between samples. So unless the Span to RBW ratio is lower than usual, then the highest sample can be well below the peak signal amplitude. Second, for the high sweep rates normally used, the peak response of the RBW filters is up to -0.5 dB. This sweeping error is compensated when using the peak and normal detectors by changing the overall gain. But the gain is not changed when in the sample detector, because doing so would cause errors in the response to noise. Instead, the auto-couple rules for sweep time are modified to give slower sweeps.

Key Path	Trace/Det, Detector
Example	DET:TRAC SAMP selects the Sample detector for trace 1.
Couplings	<p>Selecting a specific detector type turns “Auto” to false for this trace (manual).</p> <p>Selecting a detector for a trace (pressing the key or sending a [:SENS]:DET:TRAC command) puts Update On and Display On for that trace, even if that detector was already selected. Note that the legacy command [:SENS]:DET[:FUNC] does NOT exhibit this behavior.</p> <p>Selecting a detector, whether by pressing the key or sending the equivalent SCPI command, will turn trace math to Off for the selected/specified trace.</p>
Initial S/W Revision	Prior to A.02.00
Help Map ID	3327

Negative Peak

For each bucket (interval) in the trace, Negative Peak detection displays the lowest sample within the bucket. Negative peak detection is similar to peak detection, but selects the minimum video signal.

Key Path	Trace/Det, Detector
Example	DET:TRAC2 NEG selects the negative peak detector for trace 2.
Couplings	<p>Selecting a specific detector type turns “Auto” to false for this trace (manual).</p> <p>Selecting a detector for a trace (pressing the key or sending a [:SENS]:DET:TRAC command) puts Update On and Display On for that trace, even if that detector was already selected. Note that the legacy command [:SENS]:DET[:FUNC] does NOT exhibit this behavior.</p> <p>Selecting a detector, whether by pressing the key or sending the equivalent SCPI command, will turn trace math to Off for the selected/specified trace.</p>
Initial S/W Revision	Prior to A.02.00
Help Map ID	3328

Quasi Peak

Only appears with Option EMC installed and licensed.

This is a fast-rise, slow-fall detector used in making CISPR compliant EMI measurements and defined by CISPR Publication 16-1-1. Quasi-peak detection displays a weighted, sample-detected amplitude using specific, charge, discharge, and meter time constants derived from the legacy behaviors of analog

Common Measurement Functions 1

detectors and meters. It is used for EMI measurements to provide a specific and consistent response to EMI-like signals.

Note that CISPR standard operation is to perform the averaging associated with quasi peak detection on the voltage scale. The user can manually set the Average Type to Log-Power or Power, but the results will no longer be CISPR compliant.

See [“More Information” on page 1682](#).

Key Path	Trace/Det, Detector
Example	DET:TRAC3 QPE selects the quasi-peak detector for trace 3.
Dependencies	Unavailable in manual FFT sweep. Unavailable when Tune & Listen is turned on, or Demod Audio is the selected Analog Output:
Couplings	<p>If the user selects this detector on any active trace, the EMI Standard is set to CISPR. If any inactive trace with this detector selected goes active, the EMI Standard is set to CISPR.</p> <p>If the Avg Type is in Auto, and this detector is selected on any active trace, the Voltage Averaging type is auto-selected.</p> <p>The VBW filter is not used for this detector, so varying the VBW will have no effect for any traces for which this detector is selected (other than to slow down the sweep, because of the coupling to Sweep Time of VBW). If the only traces which are active are traces for which VBW does not apply (traces with Average, EMI Average, RMS Average or Quasi Peak detectors), then the VBW annotation shows “---” on the front panel, although still returns the current value of VBW to a SCPI query.</p> <p>Selecting a specific detector type turns the “Auto” on page 1677 (to false for this trace (manual).</p> <p>Selecting a detector for a trace (pressing the key or sending a [:SENS]:DET:TRAC command) puts Update On and Display On for that trace, even if that detector was already selected. Note that the legacy command [:SENS]:DET[:FUNC] does NOT exhibit this behavior.</p> <p>Selecting a detector, whether by pressing the key or sending the equivalent SCPI command, will turn trace math to Off for the selected/specified trace.</p>
Initial S/W Revision	A.02.00
Help Map ID	3329

More Information

In the past, Quasi Peak and EMI Average measurements were often made on a linear display scale because those detectors only worked properly with signals on a linear (voltage) scale. The X-series test sets are capable of making Quasi Peak and EMI Average detected measurements correctly on a log scale, due to the digital IF. This latter capability means that the user can observe detected EMI levels on a log scale, allowing a large visible dynamic range.

Also in the past, EMI analysis equipment would need to perform a ranging operation to set the reference

level when one of these detectors was turned on, but the X-series test sets do not - because of its digital IF, there is no need to set the reference level (range) to improve the accuracy nor to allow visibility of the detected level.

EMI Average

Only appears with Option EMC installed and licensed.

The EMI Average detector in Agilent’s X-Series test sets is so called to distinguish it from the Average detector, although EMI users typically refer to it simply as the “Average detector”. The intent of this detector is to provide a standard means to “smooth” the signal while still providing compliance to CISPR pulse response standards

Unlike the regular Average detector, the EMI Average detection displays the average value of the amplitude envelope, rather than the average value of sample-detected amplitude. It is defined for EMI measurements by the CISPR 16–1–1 standard and, in the X-series, uses a sophisticated algorithm to implement a lowpass filter that conforms to the latest CISPR standard.

Note that CISPR standard operation is to perform the envelope averaging on the voltage scale. The user can manually set the Average Type to Log-Power or Power, but the results will no longer be CISPR compliant.

Key Path	Trace/Det, Detector
Example	DET:TRAC3 EAV selects the EMI average detector for trace 3.
Dependencies	Unavailable in manual FFT sweep. Unavailable when Tune & Listen is turned on, or Demod Audio is the selected Analog Output:
Couplings	If the user selects this detector on any active trace, the EMI Standard is set to CISPR. If any inactive trace with this detector selected goes active, the EMI Standard is set to CISPR. If the Avg Type is in Auto, and this detector is selected on any active trace, the Voltage Averaging type is auto-selected. The VBW filter is not used for this detector, so varying the VBW will have no effect for any traces for which this detector is selected (other than to slow down the sweep, because of the coupling to Sweep Time of VBW). If the only traces which are active are traces for which VBW does not apply (traces with Average, EMI Average, RMS Average or Quasi Peak detectors), then the VBW annotation shows “---” on the front panel, although still returns the current value of VBW to a SCPI query. Selecting a detector for a trace (pressing the key or sending a [:SENS]:DET:TRAC command) puts Update On and Display On for that trace, even if that detector was already selected. Note that the legacy command [:SENS]:DET[:FUNC] does NOT exhibit this behavior. Selecting a detector, whether by pressing the key or sending the equivalent SCPI command, will turn trace math to Off for the selected/specified trace.
Initial S/W Revision	A.02.00
Help Map ID	3330

Common Measurement Functions 1

RMS Average

Only appears with Option EMC installed and licensed.

This key selects the RMS Average detector, a frequency dependent RMS/Averaging filter, used in making CISPR compliant EMI measurements. This filter conforms to the 2007 revision of the CISPR 16-1-1 standard.

This detector does one averaging process (in the VBW hardware) on the "power" (a.k.a. RMS) scale and another process on the voltage scale using a "meter movement simulator" similar to the one used in the QPD filter.

Note that the user can manually set the Average Type to Log-Power or Power, but the results will no longer be CISPR compliant.

Key Path	Trace/Det, Detector
Example	DET:TRAC3 RAV selects the RMS Average detector for trace 3.
Notes	This key / command is grayed out when you have manually selected FFT sweep.
Dependencies	Unavailable in manual FFT sweep. Unavailable when Tune & Listen is turned on, or Demod Audio is the selected Analog Output:
Couplings	Selecting a detector for a trace (pressing the key or sending a [:SENS]:DET:TRAC command) puts Update On and Display On for that trace, even if that detector was already selected. Note that the legacy command [:SENS]:DET[:FUNC] does NOT exhibit this behavior.
Couplings	If the user selects this detector on any active trace, the EMI Standard is set to CISPR. If any inactive trace with this detector selected goes active, the EMI Standard is set to CISPR. If the Avg Type is in Auto, and this detector is selected on any active trace, the Voltage Averaging type is auto-selected. The VBW filter is not used for this detector, so varying the VBW will have no effect for any traces for which this detector is selected (other than to slow down the sweep, because of the coupling to Sweep Time of VBW). If the only traces which are active are traces for which VBW does not apply (traces with Average, EMI Average, RMS Average or Quasi Peak detectors), then the VBW annotation shows "---" on the front panel, although still returns the current value of VBW to a SCPI query. Selecting a detector for a trace (pressing the key or sending a [:SENS]:DET:TRAC command) puts Update On and Display On for that trace, even if that detector was already selected. Note that the legacy command [:SENS]:DET[:FUNC] does NOT exhibit this behavior. Selecting a detector, whether by pressing the key or sending the equivalent SCPI command, will turn trace math to Off for the selected/specified trace.
Initial S/W Revision	A.02.00
Help Map ID	3863

Preset Detectors

The keys in this menu provide a quick way of setting a number of traces to convenient common detector settings. It is important to point out that these are not toggles or ‘modes’, and do not keep any detectors in a particular configuration. The effect is identical to just setting the traces’ detectors individually. These are simply one-time settings that are quicker than making many individual changes.

Dependencies	When you have manually selected FFT sweep, the Detector Preset choices that contain any CISPR detectors, are grayed out. If the grayed out key is pressed, an advisory message is generated. If the equivalent SCPI command is sent, this same message is generated as part of a “-221, Settings conflict” warning.
Preset	No interaction with preset
State Saved	Not saved in state
Initial S/W Revision	Prior to A.02.00
Help Map ID	3333

All Traces Auto

This is designed to quickly return the selected set of detectors to the “preset” state, which is auto-selected.

Couplings	Sets all traces’ Detector Auto to true.
Initial S/W Revision	Prior to A.02.00
Help Map ID	3334

Peak / Average / NPeak

This is a setting for making a measurement of the average power and the signal envelope.

Couplings	Trace 1: Set to peak detection, and Clear-Write. Trace 2: Set to average detection, and Clear-Write. Trace 3: Set to negative peak detection, and Clear-Write.
Initial S/W Revision	Prior to A.02.00
Help Map ID	3335

Peak / Sample / NPeak

This is a setting for making a measurement that displays a power sample and the signal envelope.

Couplings	Trace 1: Set to peak detection, and Clear-Write. Trace 2: Set to sample detection, and Clear-Write. Trace 3: Set to negative peak detection, and Clear-Write.
-----------	---

Common Measurement Functions 1

Initial S/W Revision	Prior to A.02.00
Help Map ID	3336

Clear Trace

Clears the selected trace (from the front panel) or the specified trace (from SCPI). Does not affect the state of any function or variable in the instrument. Loads mintracevalue into all of the points in the selected trace, unless the trace is in Min Hold in which case it loads maxtracevalue. It does this even if Update = Off.

This key only appears in the Normal View. It does not appear when in the Spectrogram View.

Key Path	Trace/Detector
Remote Command	:TRACe:CLEAr TRACE1 TRACE2 TRACE3 TRACE4 TRACE5 TRACE6
Example	TRAC:CLE TRACE1 clears trace 1
Initial S/W Revision	Prior to A.02.00
Help Map ID	3339

Clear All Traces

Clears all traces. Does not affect the state of any function or variable in the instrument. Loads mintracevalue into all of the points all traces, except traces in Min Hold in which case it loads maxtracevalue. Does so even if Update = Off.

This key only appears in the Normal View. It does not appear when in the Spectrogram View.

Key Path	Trace/Detector
Remote Command	:TRACe:CLEAr:ALL
Example	TRAC:CLE:ALL clears all traces
Initial S/W Revision	Prior to A.02.00
Help Map ID	3340

Math

This menu lets you turn on trace math functions. Trace math functions perform mathematical operations between traces and, in some cases, user-specified offsets. When in a trace math function, the indicated function is performed during the sweep with the math function used in place of a detector. The trace operands for the math function are set using the **Trace Operands** key.

See [“Math: More Information” on page 1688](#).

This key only appears in the Normal View. It does not appear when in the Spectrogram View.

Key Path	Trace/Detector
----------	-----------------------

<p>Remote Command</p>	<pre>:CALCulate:MATH TRACE1 TRACE2 TRACE3 TRACE4 TRACE5 TRACE6 , PDIFference PSUM LOFFset LDIFference OFF , TRACE1 TRACE2 TRACE3 TRACE4 TRACE5 TRACE6 , TRACE1 TRACE2 TRACE3 TRACE4 TRACE5 TRACE6 , <real> , <real> :CALCulate:MATH? TRACE1 TRACE2 TRACE3 TRACE4 TRACE5 TRACE6</pre>
<p>Notes</p>	<p>The lower level menu, which contains an embedded 1-of-N, does not auto-return when a selection is made.</p>
<p>Notes</p>	<p>The Trace Math Function command has 6 main set of parameters:</p> <ul style="list-style-type: none"> - Set 1 defines the “result trace”: TRACE1 TRACE2 TRACE3 TRACE4 TRACE5 TRACE6 -Set 2 defines the “function”: PDIFference PSUM LOFFset LDIFference OFF - Set 3 is a “trace operand” (1): TRACE1 TRACE2 TRACE3 TRACE4 TRACE5 TRACE6 - Set 4 is a “trace operand” (2): TRACE1 TRACE2 TRACE3 TRACE4 TRACE5 TRACE6 - Set 5 defines the “Log Offset” (in dB). - Set 6 defines the “Log Difference Reference” (in dBm). <p>Note that the trace math mode is an enumeration; that is, when a math function is set for a trace it turns off any math function that is on for that trace and sets the new math function.</p> <p>The parameters sent in the command are reflected in the values in the key menu. There is no default for any parameter; all 6 parameters must be sent to satisfy the parser. Failure to specify a parameter will result in a missing parameter error.</p> <p>Note that for some of the math modes some of the parameters are not relevant. For those modes, the parameters are ignored, and sending “,” is sufficient for those parameters.</p> <p>The query returns the math mode, the operand traces, the offset and the reference for the specified trace, all separated by commas. The return value of irrelevant parameters is undefined; empty fields (“,”) would be desirable.</p> <p>Remote command examples are included in each section below.</p>
<p>Dependencies</p>	<p>Trace Math is not available if Normalize is on.</p> <p>None of the trace operands can be the destination trace. If any of the three trace math commands is sent with a destination trace number matching one of the operands a warning is generated and the function does not turn on.</p>
<p>Couplings</p>	<p>Whenever a math function is turned on for a trace, that trace is set to Display = On and Update = On.</p>

Common Measurement Functions 1

Preset	OFF,TRACE5,TRACE6,0,0 OFF,TRACE6,TRACE1,0,0 OFF,TRACE1,TRACE2,0,0 OFF,TRACE2,TRACE3,0,0 OFF,TRACE3,TRACE4,0,0 OFF,TRACE4,TRACE5,0,0
State Saved	The trace math function for each trace is saved in Instrument State.
Status Bits/OPC dependencies	*OPC can be used to detect the completion of a sweep, which will also correspond to the completion of the math operation, since all math takes place during the sweep
Initial S/W Revision	Prior to A.02.00
Help Map ID	3341

Math: More Information

IMPORTANT: to generate a trace math result, you must take a sweep. The trace math engine, described below, operates in concert with the sweep engine in the test set. Until a sweep has been taken, even if the constituent traces are not in Update mode, no result is generated. Note that certain events can affect the trace in ways that affects all points at once. This can happen in any number of ways, including:

A trace clear taking place

A trace being loaded from the file system

Trace data being sent in from the remote interface

A copy or exchange of trace data

You should try to avoid these occurrences during a sweep, as they will tend to invalidate the math result being accumulated.

How trace math is processed:

Whenever a trace math function is turned on, or the parameters and/or operands of an existing trace math function are changed, the destination trace is cleared. After the trace is cleared, all x-axis values in the trace, and the domain of the trace, are set to match the X-axis settings of the first trace operand. When this is complete, a new sweep is initiated.

The process of acquiring data, processing it using the math and average/hold functions, and presenting it to the user as trace data, consists of several functional blocks, as shown below:

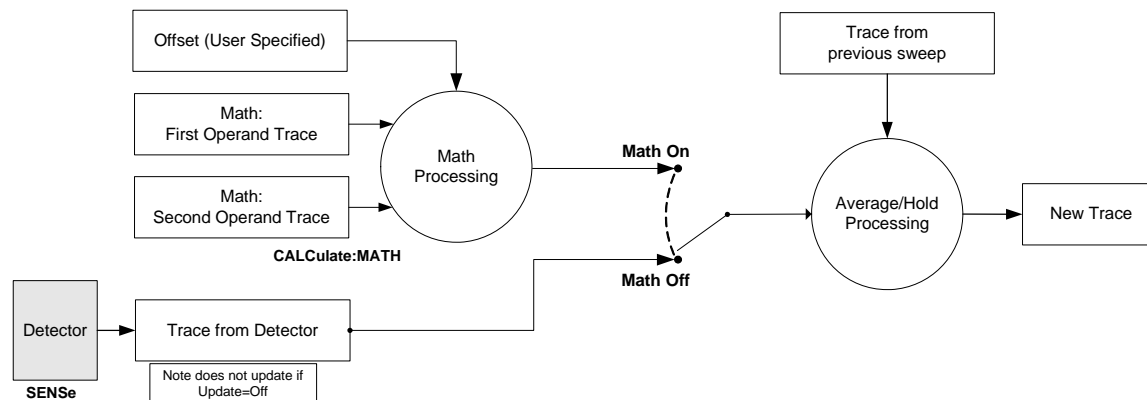

For each active trace, the current trace point is processed for Trace 1, then Trace 2, then Trace 3, et

cetera. Trace data is taken from either the detector for that trace, or from the mathematical result of up to two other traces and an offset, depending on whether trace math is on or not. The resultant data is then fed to the Average/Hold processing block, where (if the trace type is Average, Max Hold, or Min Hold) it is processed with previous trace data. The new trace data resulting from this process is then available for display, storage or remote output.

When the processing is complete for Trace 1, Trace 2 is processed, and so on until all six traces have been processed. This allows a downstream trace to use as one of its math components a fully processed upstream trace. In other words, if math is on for Trace 4, and its operand traces are Trace 2 and Trace 3, all detector, math, average and hold processing for traces 2 and 3 is complete before the math is performed for trace 4. When the current trace point is completed for all traces, the test set moves on to the next trace point.

Power Diff (Op1-Op2)

Calculates a power difference between the **First Trace** operand and the **Second Trace** operand and puts the result in the destination trace.

During the sweep, the following formula is executed for each point in the trace operands, and the corresponding point is generated for the destination trace:

$$\text{DestinationTrace} = 10 \log(10(1/10)(\text{FirstTrace}) - 10(1/10)(\text{SecondTrace}))$$

The values of the trace points are assumed to be in a decibel scale, as they are internally stored.

If a point in FirstTrace is equal to maxtracevalue, the resultant point is also maxtracevalue.

Otherwise, if the result of the subtraction is less than or equal to 0, the resultant point is mintracevalue.

Key Path	Trace/Detector, Math
Example	:CALC:MATH TRACE1,PDIF,TRACE4,TRACES5,, sets Trace 1 to Power Diff trace math function, and sets the First Trace operand (for Trace 1) to Trace 4 and the Second Trace operand (for Trace 1) to Trace 5.
Couplings	Selecting a math mode other than Off for a trace (pressing the key or sending the equivalent SCPI command) puts the trace in View (Update On and Display On), even if that math mode was already selected.
Initial S/W Revision	Prior to A.02.00
Help Map ID	3342

Power Sum (Op1+Op2)

Calculates a power sum between the **First Trace** operand and the **Second Trace** operand and puts the result in the destination trace.

During the sweep, the following formula is executed for each point in the trace operands, and the corresponding point is generated for the destination trace.:

$$\text{DestinationTrace} = 10 \log(10(1/10)(\text{FirstTrace}) + 10(1/10)(\text{SecondTrace}))$$

The values of the trace points are assumed to be in a decibel scale, as they are internally stored.

Common Measurement Functions 1

If a point in either trace operand is equal to maxtracevalue, the resultant point is also maxtracevalue.

Key Path	Trace/Detector, Math
Example	: CALC:MATH TRACE1, PSUM, TRACE4, TRACE5, , sets Trace 1 to Power Sum trace math function and sets the First Trace operand (for Trace 1) to Trace 4 and the Second Trace operand (for Trace 1) to Trace 5.
Couplings	Selecting a math mode other than Off for a trace (pressing the key or sending the equivalent SCPI command) puts the trace in View (Update On and Display On), even if that math mode was already selected.
Initial S/W Revision	Prior to A.02.00
Help Map ID	3343

Log Offset (Op1 + Offset)

Calculates a log offset from the **First Trace** operand and puts the result in the destination trace. This is like the B-DL function in some older test sets. The offset is entered as the active function. Each destination trace has its own offset.

During the sweep, the following formula is executed for each point in the trace operand, and the corresponding point is generated for the destination trace.:

$$\text{DestinationTrace} = \text{FirstTrace} + \text{Offset}$$

The values of the trace points are assumed to be in dBm (as they are internally stored) and the offset is in dB.

If a point in the trace operand is equal to maxtracevalue, the resultant point is also maxtracevalue.

If a point in the trace operand is equal to mintracevalue, the resultant point is also mintracevalue.

Example: If offset is 25 dB, then our destination trace is higher than the operand trace by 25 dB.

Note that the **Second Trace** operand is not used for this function.

Key Path	Trace/Detector, Math
Example	: CALC:MATH TRACE1, LOFF, TRACE4, , -6.00, sets Trace 1 to Log Offset trace math function, sets the First Trace operand (for Trace 1) to Trace 4, leaves the Second Trace operand (for Trace 1) unchanged (it is irrelevant for this function) and sets the Log Offset (for Trace 1) to -6 dB.
Couplings	Selecting a math mode other than Off for a trace (pressing the key or sending the equivalent SCPI command) puts the trace in View (Update On and Display On), even if that math mode was already selected.
State Saved	The Log Offset value for each trace is saved in Instrument State
Min	-100 dB
Max	100 dB

Initial S/W Revision	Prior to A.02.00
Help Map ID	3344

Log Diff (Op1-Op2+Ref)

Offsets the difference between the **First Trace** operand and the **Second Trace** operand by a reference and puts the result in the destination trace. This is like the A-B+DL function in some older test sets. The reference is entered as the active function. Each destination trace has its own reference.

During the sweep, the following formula is executed for each point in the trace operands, and the corresponding point is generated for the destination trace:

$$\text{DestinationTrace} = (\text{FirstTrace} - \text{SecondTrace}) + \text{Reference}$$

The values of the operand trace points are assumed to be in decibel units (as they are internally stored) and the reference is in dBm so the result is in dBm.

Example: If the first operand trace 1 is at 5 dBm, the second operand trace 2 is at -5 dBm, and the reference is -25 dBm, then the destination trace is -15 dBm.

Example: If the first operand trace1 is at 60 dBuV, the second operand trace 2 is at 50 dBuV, and the reference is 35 dBuV, then the destination trace is 45 dBuV.

See [“More Information” on page 1691](#).

Key Path	Trace/Detector, Math
Example	:CALC:MATH TRACE1,LDIF,TRACE4,TRACE5,,-6.00 sets Trace 1 to Log Diff trace math function, sets the First Trace operand (for Trace 1) to Trace 4, sets the Second Trace operand (for Trace 1) to Trace 5, and sets the Log Difference reference for Trace 1 to -6 dBm.
Couplings	Selecting a math mode other than Off for a trace (pressing the key or sending the equivalent SCPI command) puts the trace in View (Update On and Display On), even if that math mode was already selected.
State Saved	The Log Difference reference value for each trace is saved in Instrument State
Min	Same as reference level
Max	Same as reference level
Default Unit	depends on the current selected Y axis unit
Initial S/W Revision	Prior to A.02.00
Help Map ID	3345

More Information

If a point in FirstTrace is equal to maxtracevalue, the resultant point is also maxtracevalue.

If a point in FirstTrace is equal to mintracevalue, the resultant point is also mintracevalue.

If neither of the above is true for a given point, then:

Common Measurement Functions 1

If that point in SecondTrace is equal to maxtracevalue, the resultant point is mintracevalue.

If that point in SecondTrace is equal to mintracevalue, the resultant point is maxtracevalue.

Off

Turns off Trace Math.

Key Path	Trace/Detector, Math
Example	CALC:MATH TRACE1 OFF turns off trace math for trace 1.
Notes	See Trace "Math".
State Saved	The current trace math function is saved in Instrument State
Readback	Off
Initial S/W Revision	Prior to A.02.00
Help Map ID	3346

Operands

Selects the trace operand(s) to be used for the trace math functions for the destination trace.

Key Path	Trace, Math
Notes	The operands of the trace math commands specify the trace operands. Since the operands are common to all math functions for a given trace, the most recently sent math function command sets the operands for each trace and are reflected on the trace operand keys.
Dependencies	The destination trace cannot be an operand.
Readback line	In square brackets, the First Trace operand, new line, and the second trace operand, as: [Op1 = Trace 1, Op2 = Trace2] where Trace 1 is operand 1 and Trace 2 is operand 2.
Initial S/W Revision	Prior to A.02.00
Help Map ID	3347

Operand 1

Selects the first trace operand to be used for the trace math functions for the destination trace.

Key Path	Trace, Math, Trace Operands
Dependencies	The First Trace cannot be the same as the destination trace. The destination trace number is gray on the key, and the underline skips that number when selecting the trace.

Preset	Trace number – 2 (wraps at 1). For example, for Trace 1, the First Trace presets to Trace 5; for Trace 6, it presets to Trace 4.
State Saved	The First Trace operand for each trace is stored in instrument state.
Readback	Trace <trace number>
Initial S/W Revision	Prior to A.02.00
Help Map ID	3348

Operand 2

Selects the second trace operand to be used for the trace math functions for the destination trace.

Key Path	Trace, Math, Trace Operands
Dependencies	The Second Trace cannot be the same as the destination trace. The destination trace number is gray on the key, and the underline skips that number when selecting the trace.
Preset	Trace number – 1 (wraps at 1). For example, for Trace 1, the Second Trace presets to Trace 6; for Trace 6, it presets to Trace 5.
State Saved	The Second Trace operand for each trace is stored in instrument state
Readback	Trace <trace number>
Initial S/W Revision	Prior to A.02.00
Help Map ID	3349

Normalize

Displays menu keys that let you normalize trace data.

This key only appears in the Normal View. It does not appear when in the Spectrogram View.

Key Path	Trace/Detector
Readback	[On] or [Off]
Initial S/W Revision	Prior to A.02.00
Help Map ID	3350

Normalize On/Off

Normalize (On) activates the normalize function. On each sweep, the normalized trace (Trace 3) is subtracted from Trace 1 and the result is added to the normalized reference level. This arithmetic assumes all values are in decibel units, so we are actually taking a ratio.

This key only appears in the Normal View. It does not appear when in the Spectrogram View.

See [“More Information” on page 1694](#).

Common Measurement Functions 1

See “Normalize Block Diagram” on page 1695.

Key Path	Trace/Detector, Normalize
Remote Command	:CALCulate:NTData[:STATe] OFF ON 0 1 :CALCulate:NTData[:STATe]?
Example	CALC:NTD ON CALC:NTD?
Dependencies	<ul style="list-style-type: none">• If Normalize (On) is pressed before Store Ref (1 3), an error message is generated. Normalize remains off in this case.• Normalize is not available (grayed out) if any Trace Math function is on.
Couplings	When Normalize is turned on, Trace 1 is placed in Clear/Write with Update = On and Display = On.
Preset	OFF
State Saved	Saved in Instrument State.
Initial S/W Revision	Prior to A.02.00
Help Map ID	3351

More Information

First the following calculation is performed:

Trace 1 = (Trace 1D – Normalized Trace)

Where:

Trace 1D is the measured value of trace 1, as it comes from the SENSE subsystem.

Normalized Trace is Trace 3, in which you have previously stored a reference trace

All values are in decibel units.

This Trace 1 contains the values that are returned from a trace query, or if the marker is placed on the trace.

For example, let's say bucket 1 on Trace 1 is at 0 dBm, and bucket 1 on Trace 3 is at 10 dBm. The resultant bucket is at 0 dBm – 10 dBm = –10 dB (just like with a delta marker).

You are also given the ability to define what (dB) value to use for Ref Level, and to define where on the screen the Ref Lvl line will appear using Normalized Reference Position. This flexibility in displaying the result allows a wide range of devices, including amplifiers, to be tested using Normalize.

In the example above, bucket 1 has the value of –10 dB. Let us assume you have set Norm Ref Lvl to 5 dB. Thus bucket 1 will display 1.5 divisions below the Reference Level line (assuming 10 dB per division).

The Reference Level line is normally the top line of the graticule. If Norm Ref Posn is set to 10, this is the case. If it is set to 9, it is the next line down. If it is set to 5, it is the middle line of the graticule. If set to 0 it is the bottom line.

So in the example above, if Norm Ref Posn is set to 9, then bucket 1 will display 2.5 divisions below the top line of the graticule.

None of the manipulations of Norm Ref Posn and Norm Ref Lvl affect the data in the trace.

As Normalize displays a ratio between two traces (a difference, in dB) the Y-Axis Unit while in Normalize is dB in Log Amplitude and dimensionless in Linear. The Y-axis unit chosen in the Y-axis unit menu is unaffected by Normalize. When you leave Normalize the Y-axis unit returns to the value set in the Y-axis unit menu. While in Normalize, all amplitude functions, such as Marker Y and the values in other traces, should be always in dB unit, and so should the returned trace query results. In other words, both trace query result and marker Y become independent of the Y-axis unit chosen in the Y-axis unit menu when normalize is on.

(In Linear, the equivalent calculation is performed but it yields a dimensionless ratio, so the normalized reference level is unitless, presetting to 1, just as in Log it presets to 0 dB).

Y-axis annotation is blanked while in Normalize. Any other traces on the display are plotted in dB, where the dB value used is equivalent to the dBm value of the trace. For example, if bucket 1 in trace 2 is at -40 dBm, that bucket is plotted at -40 dB. All traces use Norm Ref Lvl and Norm Ref Posn for positioning on the display. When Normalize exits, the normal Ref Lvl is restored. This normal Ref Level is unaffected by Normalize.

Normalize Block Diagram

A block diagram showing how Normalize works is presented below:

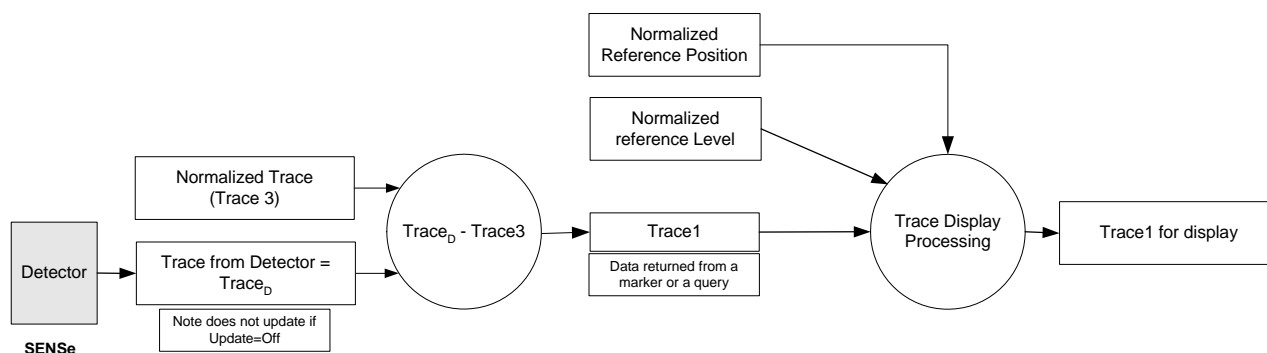

The normalize function is most useful for applying correction data to a trace while making a stimulus-response measurement with a tracking generator (or synchronized source). For example, connect the cables and a through line, in place of the device to be measured, between the tracking generator and the test set input. Notice that the frequency response is not perfectly flat, showing the response of the cables, as well as the flatness of both the tracking generator and the test set. Now press Store Ref (1 3), Normalize On. Notice that the displayed trace is now flat, or normalized. The position of the normalized trace can now be moved to a different position on the display by changing the normalized reference position. This may be useful if the device to be tested has positive gain, such as an amplifier. Now replace the through line with the device under test, and an accurate measurement of the gain or loss can be made.

Store Ref (1 -> 3)

Copies trace 1 into trace 3. Store Ref (1 3) must be pressed before pressing Normalize (On). Note that this puts Trace 3 in Update = Off (not updating) and Display = On (visible).

Key Path	Trace/Detector, Normalize
Notes	There is no remote command for this function, however the trace copy command can be used for this purpose.
Dependencies	<ul style="list-style-type: none"> If Normalize (On) is pressed before Store Ref (1 3), an error message is generated. Normalize remains off in this case.
Initial S/W Revision	Prior to A.02.00

Common Measurement Functions 1

Help Map ID	3352
-------------	------

Show Ref Trace (Trace 3)

Views or blanks the reference trace on the display. The reference trace is trace 3, so this is the same as setting Trace 3's "Display" attribute.

Key Path	Trace/Detector, Normalize
Example	TRAC3:DISP 1 shows the reference trace.
Notes	Use the TRAC3:DISP command to show or blank the reference trace Trace 3 is always the reference trace by definition.
State Saved	Saved in instrument state.
Initial S/W Revision	Prior to A.02.00
Help Map ID	3353

Norm Ref Lvl

Sets the level (in dB) of the normalized reference.

Key Path	Trace/Detector, Normalize
Remote Command	:DISPlay:WINDow[1]:TRACe:Y[:SCALe]:NRLevel <rel_ampl> :DISPlay:WINDow[1]:TRACe:Y[:SCALe]:NRLevel?
Example	DISP:WIND:TRAC:Y:NRL .10 dB DISP:WIND:TRAC:Y:NRL?
Preset	0 dB
State Saved	Saved in instrument state.
Min	-327.6 dB
Max	327.6 dB
Initial S/W Revision	Prior to A.02.00
Help Map ID	3354

Norm Ref Posn

Offsets the displayed trace without affecting the instrument gain or attenuation settings. This allows the displayed trace to be moved without decreasing measurement accuracy. The normalized reference position is indicated with a right arrow on the left side of the display and a left arrow on the right side of the display, just inside the graticule. See picture below:

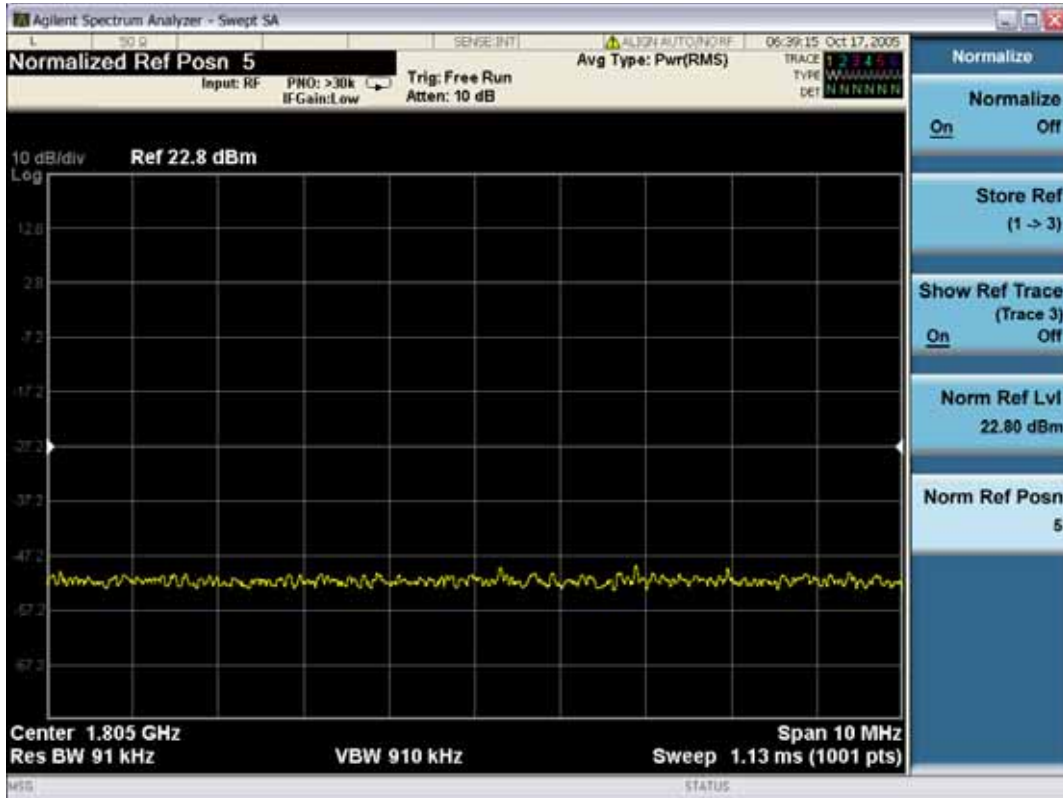

Key Path	Trace/Detector, Normalize
Remote Command	:DISPlay:WINDow[1]:TRACe:Y[:SCALe]:NRPosition <integer> :DISPlay:WINDow[1]:TRACe:Y[:SCALe]:NRPosition?
Example	DISP:WIND:TRAC:Y:NRP 5 DISP:WIND:TRAC:Y:NRP?
Notes	The top and bottom graticule lines correspond to 10 and 0, respectively.
Preset	10
State Saved	Saved in Instrument State.
Min	0
Max	10
Initial S/W Revision	Prior to A.2.00
Help Map ID	3355

Copy/Exchange

This menu lets you copy any trace to any other trace, or exchange any trace with any other trace. The action is performed once, it is not an “every sweep” type of thing.

Common Measurement Functions 1

The X-axis settings and domain of a trace go with it when it is copied or exchanged.

Key Path	Trace/Detector
Remote Command	:TRACe:COPIY TRACE1 TRACE2 TRACE3 TRACE4 TRACE5 TRACE6 , TRACE1 TRACE2 TRACE3 TRACE4 TRACE5 TRACE6 :TRACe:COPIY?
Example	TRAC:COPIY TRACE1,TRACE3 copies Trace 1 to Trace 3 and puts Trace 3 in Update = Off, Display = On
Notes	The TRACe:COPIY command is of the form: :TRACe:COPIY <source_trace>,<dest_trace>
Notes	In the case of a Copy , the destination trace is put in Update = Off, Display = On after the copy. In the case of an Exchange , both traces are put into Update = Off, Display = On after the exchange.
Preset	TRACE1, TRACE2
Initial S/W Revision	Prior to A.02.00
Help Map ID	3356

Remote Command:	:TRACe:EXCHange TRACE1 TRACE2 TRACE3 TRACE4 TRACE5 TRACE6 , TRACE1 TRACE2 TRACE3 TRACE4 TRACE5 TRACE6 :TRACe:EXCHange?
Example:	TRAC:EXCH TRACE1,TRACE2 exchanges Trace 1 and Trace 2 and puts both traces in Update = Off, Display = On .
Notes:	The TRACe:EXCHange command is of the form: :TRACe:EXCHange <trace_1>,<trace_2>
Preset:	TRACE1, TRACE2
Initial S/W Revision:	Prior to A.02.00
Help Map ID:	3357

From Trace

Selects the trace to be copied to or exchanged with the **To Trace**

Key Path	Trace/Detector, Copy/Exchange
Notes	See "Copy/Exchange".
Preset	1
Initial S/W Revision	Prior to A.02.00
Help Map ID	3358

To Trace

Selects the trace to be copied from or exchanged with the **From Trace**

Key Path	Trace/Detector, Copy/Exchange
Notes	See “Copy/Exchange”.
Preset	2
Initial S/W Revision	Prior to A.02.00
Help Map ID	3359

Copy Now

Executes the Copy operation and puts the destination trace in **Update = Off, Display = On**.

Key Path	Trace/Detector, Copy/Exchange
Notes	See “Copy/Exchange”.
Initial S/W Revision	Prior to A.02.00
Help Map ID	3360

Exchange Now

Executes the Exchange operation and puts both traces in **Update = Off, Display = On**.

Key Path	Trace/Detector, Copy/Exchange
Notes	See “Copy/Exchange”.
Initial S/W Revision	Prior to A.02.00
Help Map ID	3361

Send/Query Trace Data (Remote Command Only)

This command allows trace data to be sent to the test set or queried from the test set. The response to the query is a list of the amplitude points which comprise the requested trace in the current Y-axis unit of the test set. The X-axis unit is that of the destination trace (for send) or the source trace (for query).

See “[Query Trace Data](#)” on page 1700.

See “[More Information](#)” on page 1700.

Remote Command:	:TRACe [:DATA] TRACE1 TRACE2 TRACE3 TRACE4 TRACE5 TRACE6, <data>
------------------------	---

Common Measurement Functions 1

Notes:	<p>The TRACe[:DATA] command is of the form:</p> <pre>:TRACe:DATA <trace>, <data></pre> <p>where <trace> can be one of the following parameters:</p> <p>TRACE1, TRACE2, TRACE3, TRACE4, TRACE5, TRACE6</p> <p>and where <data> can be</p> <ul style="list-style-type: none"> - ASCII data, which consists of a string of values separated by comma or - REAL or INTeger sent as a definite length block, with a header describing the data to follow.
Couplings:	<p>Sweep points will affect the amount of data</p> <p>The FORMat:DATA command describes the different types of data formats that can be used with trace data.</p> <p>Use the FORMat:BORDer command to set the byte order.</p>
Initial S/W Revision:	Prior to A.02.00
Help Map ID:	3362

Query Trace Data

Remote Command:	:TRACe[:DATA]? TRACE1 TRACE2 TRACE3 TRACE4 TRACE5 TRACE6
Example:	<p>TRAC TRACE1,-1,-2,-3,-4,-5 sends five points to Trace 1. Assuming that FORMat:DATA is set to ASCII, Y-axis unit is set to dBm, and sweep points is set to 5, this will result in Trace 1 consisting of the five points -1 dBm, -2 dBm, -3 dBm, -4 dBm, and -5 dBm.</p> <p>TRAC? TRACE2 queries the test set for the contents of trace 2.</p>
Initial S/W Revision:	Prior to A.02.00
Help Map ID:	3363

More Information

The format and byte-ordering of the sent or received data is dependent on the FORMat :DATA and FORMat :BORDer commands. ASCII data consists of a string of comma separated values. REAL or INTeger data is sent as a definite length block, with a header describing the data to follow.

For example, a four point trace might look like this if in ASCII (FORMat :DATA ASCII):

```
-5.87350E+01, -5.89110E+01, -5.87205E+01, -5.12345E+01<NL><END>
```

and like this if in INTeger with 4 bytes per point (FORMat :DATA INT, 32):

```
#216<16 bytes of data><NL><END>
```

where the 2 in the #216 means “2 digits of numeric data to follow”, and the 16 is the 2 digits and means “16 binary bytes to follow” (this is the definite length block format).

Note that the data is terminated with <NL><END>. (For GPIB this is newline, or linefeed, followed by EOI set true. For LAN, this is newline only.)

The data format set by FORMat :DATA and FORMat :BORDER is used both for sending data to the instrument and receiving data from the instrument.

When sending data to the instrument, the data block must contain exactly the number of points currently specified in **Sweep, Points** or error is generated and there is no change to the target trace.

No units terminator (for example, dB or V) is used when sending data; the data is taken as being in the current Y-axis unit of the test set.

When a trace is sent to the instrument, it immediately overwrites all of the data in the target trace, even if that trace is inactive, or even if it is active and in the middle of a sweep. If in the middle of a set of **Trace Average** or **Max/Min Hold** operations, it can totally mess up the result, so you must be careful. Similarly, when querying trace data, it is best if the test set is not sweeping during the query. Therefore, it is generally advisable to be in **Single Sweep, or Update = Off** when sending trace data to the test set or querying trace data from the test set.

Format Data: Numeric Data (Remote Command Only)

This command specifies the format of the trace data input and output. It specifies the formats used for trace data during data transfer across any remote port. It affects only the data format for setting and querying trace data for the :TRACe[:DATA], TRACe[:DATA]?, :CALCulate:DATA[n]? and FETCh:SANalyzer[n]? commands and queries.

Remote Command:	:FORMat [:TRACe] [:DATA] ASCii INTeger, 32 REAL, 32 REAL, 64 :FORMat [:TRACe] [:DATA] ?
Notes:	<p>The query response is:</p> <p>ASCii: ASC,8</p> <p>REAL,32: REAL,32</p> <p>REAL,64: REAL,64</p> <p>INTeger,32: INT,32</p> <p>When the numeric data format is REAL or ASCii, data is output in the current Y Axis unit. When the data format is INTeger, data is output in units of m dBm (.001 dBm).</p> <p>The INT,32 format returns binary 32-bit integer values in internal units (m dBm), in a definite length block.</p>
Dependencies:	<p>Sending a data format spec with an invalid number (for example, INT,48) generates no error. The analyzer simply uses the default (8 for ASCii, 32 for INTeger, 32 for REAL).</p> <p>Sending data to the analyzer which does not conform to the current FORMat specified, results in an error. Sending ASCII data when a definite block is expected generates message -161 "Invalid Block Data" and sending a definite block when ASCII data is expected generates message -121 "Invalid Character in Number".</p>

Common Measurement Functions 1

Preset:	AScii
Backwards Compatibility Notes:	Note that the INT,32 format is only applicable to the command, TRACe:DATA. This preserves backwards compatibility for the Swept SA measurement. For all other commands/queries which honor FORMat:DATA, if INT,32 is sent the analyzer will behave as though it were set to REAL,32.
Initial S/W Revision:	Prior to A.02.00
Help Map ID:	0

The specs for each output type follow:

AScii - Amplitude values are in ASCII, in the current Y Axis Unit, one ASCII character per digit, values separated by commas, each value in the form:

SX.YYYYYEsZZ

Where:

S = sign (+ or -)

X = one digit to left of decimal point

Y = 5 digits to right of decimal point

E = E, exponent header

s = sign of exponent (+ or -)

ZZ = two digit exponent

REAL,32 - Binary 32-bit real values in the current Y Axis Unit, in a definite length block.

REAL,64 - Binary 64-bit real values in the current Y Axis Unit, in a definite length block.

Format Data: Byte Order (Remote Command Only)

This command selects the binary data byte order for data transfer and other queries. It controls whether binary data is transferred in normal or swapped mode. This command affects only the byte order for setting and querying trace data for the :TRACe[:DATA], TRACe[:DATA]? , :CALCulate:DATA[n]? and FETCh:SANalyzer[n]? commands and queries.

By definition any command that says it uses FORMat:DATA uses any format supported by FORMat:DATA.

The NORMal order is a byte sequence that begins with the most significant byte (MSB) first, and ends with the least significant byte (LSB) last in the sequence: 1|2|3|4. SWAPped order is when the byte sequence begins with the LSB first, and ends with the MSB last in the sequence: 4|3|2|1.

Remote Command:	:FORMat:BORDER NORMal SWAPped :FORMat:BORDER?
Preset:	NORMal
Initial S/W Revision:	Prior to A.02.00

Help Map ID:

0

Smooth Trace Data (Remote Command Only)

Not recommended for new designs. Use the CALCulate:DATA:COMPRESS command instead.

Smooths the trace according to the number of points specified in :TRACe:MATH:SMOoth:POINts. There is no equivalent front panel function.

The purpose of this function is to perform a spatial video averaging, as compared to the temporal version supplied by the video-average command [:SENSe]:AVERAge:TYPE VIDEo. The functions of TRACe:MATH:SMOoth <trace> and [:SENSe]:AVERAge:TYPE VIDEo|POWEr are not interchangeable.

Remote Command:	:TRACe:MATH:SMOoth TRACE1 TRACE2 TRACE3 TRACE4 TRACE5 TRACE6
Initial S/W Revision:	Prior to A.02.00
Help Map ID:	3367

Number of Points for Smoothing (Remote Command Only)

Not recommended for new designs. (Will not be supported in future designs.) Use the CALCulate:DATA:COMPRESS command instead.

Specifies the number of points that are smoothed. Increasing the number of points increases smoothing at the cost of decreasing resolution. If the number of points is an even number, then the number of points is increased by one. If the number of points is larger than the number of sweep points, then the number of sweep points is used, unless the number of sweep points is even, in which case the number of points is the sweep points minus one. The number of points smoothed is always an odd number.

Remote Command:	:TRACe:MATH:SMOoth:POINts <integer> :TRACe:MATH:SMOoth:POINts?
Example:	TRAC:MATH:SMO:POIN 501
Notes:	Only odd values allowed; if <integer> even, add 1 unless <integer> = number of sweep points, in which case subtract 1 Used with the TRACe:MATH:SMOoth command.
Preset:	11
Min:	3
Max:	Number of sweep points
Initial S/W Revision:	Prior to A.02.00
Help Map ID:	3368

Mean Trace Data (Remote Command Only)

Not recommended for new designs. Use the CALCulate:DATA:COMPRESS command instead.

Common Measurement Functions 1

Returns the mean of the amplitudes of the trace amplitude elements in measurement units.

Remote Command:	:TRACe:MATH:MEAN? TRACE1 TRACE2 TRACE3 TRACE4 TRACE5 TRACE6
Example:	TRAC:MATH:MEAN? TRACE2
Initial S/W Revision:	Prior to A.02.00
Help Map ID:	3369

Display Trace Time Query (Remote Command Only)

Can be used to determine the time that the current trace in the spectrogram started.

Remote Command	:TRACe:DISPlay:VIEW:SPECTrogram:TIME?
Example	:TRAC:DISP:VIEW:SPEC:TIME? Returns the start time of the Display Trace relative to the start time of the “live” trace (Spectrogram Trace 1)
Dependencies	Only available in the Spectrogram View of the Swept SA measurement. If the command is sent in any other View, an error is generated
Initial S/W Revision	A.07.01
Help Map ID	0

Trigger

Accesses a menu of keys to control the selection of the trigger source and the setup of each of the trigger sources. The test set is designed to allow triggering from a number of different sources, for example, Free Run, Video, External, RF Burst, and so forth.

The TRIG:SOURCe command (below) will specify the trigger source for the currently selected input (RF or I/Q). If you change inputs, the new input remembers the trigger source it was last programmed to for the current measurement, and uses that trigger source. You can directly set the trigger source for each input using the TRIGger:RF:SOURce and TRIGger:IQ:SOURce commands (later in this section).

Note the inclusion of the <measurement> parameter in the command below. Because each measurement remembers its own Trigger Source, the command must be qualified with the measurement name.

See [“Trigger Source Presets” on page 1706](#)

See [“RF Trigger Source” on page 1707](#)

See [“I/Q Trigger Source” on page 1708](#)

See [“More Information” on page 1709](#)

Remote Command	:TRIGger:<measurement>[:SEQuence]:SOURce EXTernal1 EXTernal2 IMMEDIATE LINE FRAME RFBurst VIDEo IF ALARm LAN IQMag IDEMod QDEMod IINPut QINPut AIQMag :TRIGger:<measurement>[:SEQuence]:SOURce?
-----------------------	--

Example	<p>TRIG:ACP:SOUR EXT1</p> <p>Selects the external 1 trigger input for the ACP measurement and the selected input</p> <p>TRIG:SOUR VID</p>
Initial S/W Revision	Prior to A.02.00
Key Path	Front-panel key
Notes	<p>Not all measurements have all the trigger sources available to them. Check the trigger source documentation for your specific measurement to see what sources are available.</p> <p>Not all trigger sources are available for each input. See the “RF Trigger Source” on page 1707 and “I/Q Trigger Source” on page 1708 commands for detailed information on which trigger sources are available for each input.</p> <p>Other trigger-related commands are found in the INITiate and ABORt SCPI command subsystems.</p> <p>*OPC should be used after requesting data. This will hold off any subsequent changes to the selected trigger source, until after the sweep is completed and the data is returned.</p> <p>Available ranges and presets can vary from mode to mode.</p>
Dependencies	In some models, there is no second External input. In these models, the External 2 key is blanked and the EXternal2 parameter will generate a “Hardware missing; Not available for this model number” error
Preset	See table below
Status Bits/OPC dependencies	The Status Operation Register bit 5 "Waiting for Trigger" is set at the same time as the Sweeping or Measuring bit is set. It is cleared when the trigger actually occurs (that is, after the trigger event occurs and all the applicable trigger criteria have been met). A corresponding pop-up message ("Waiting for trigger") is generated if no trigger signal appears after approximately 2 sec. This message goes away when a trigger signal appears.
Backwards Compatibility SCPI	<p>[[:SENSe]:<measurement>:TRIGger:SOURce</p> <p>This backwards compatibility command does not apply to the monitor spectrum, log plot and spot frequency measurements at all.</p> <p>The backwards Compatibility SCPI command, [[:SENSe]:ACPR:TRIGger:SOURce, is provided to support the same functionality as [[:SENSe]:ACPr:TRIGger:SOURce (PSA W-CDMA, PSA cdma2000 and PSA 1xEVDO) due to the fact that the ACPr node conflicts with the ACPower node.</p> <p>In earlier instruments, the parameter IF was used by apps for the video trigger, so using the IF enum selects video triggering.</p> <p>Sending IF in the command causes VID to be returned to a query.</p>
Modified at S/W Revision	A.03.00
Help Map ID	3371

Common Measurement Functions 1

Trigger Source Presets

Here are the Trigger Source presets for the various measurements:

Meas	Mode	Preset for RF	Preset for IQ	Notes
CHP	WCDMA, C2K, 1xEVDO, LTE	IMM	IQ not supported	
OBW	WCDMA, C2K, 1xEVDO, LTE	1xEVDO: EXT1 others: IMM	IQ not supported	For 1xEVDO mode, the trigger source is coupled with the gate state, as well as the gate source. When the trigger source changes to RFBurst, External1 or External2, the gate state is set to on, and the gate source is set identically with the trigger source. When the trigger source changes to IMMEDIATE, VIDEO, LINE, FRAME or IF, the gate state is set to off.
CCDF	WCDMA, C2K, 1xEV-DO, LTE	WCDMA, C2K, LTE: IMMEDIATE RFBurst	IMM	
ACP	WCDMA, C2K, 1xEVDO, LTE	IMM	IQ not supported	
Tx Power	GSM	GSM: RFBurst	IMM	
SPUR	WCDMA, C2K, 1xEV-DO, LTE	IMM	IQ not supported	
SEM	WCDMA, C2K, 1xEVDO, LTE	WCDMA, C2K, LTE, 1xEVDO(BTS): EXTernal1	IQ not supported	
CDP	WCDMA	IMM	IMM	
RHO	WCDMA	IMM	IMM	
QPSK	WCDMA, C2K, 1xEVDO	All except CDMA1xEVDO: IMMEDIATE CDMA1xEVDO: EXT1	IMM	
EVM	LTE	IMM	IMM	LTE supports Free Run, Video and External 1 only.
SPEC	BASIC	IMM	IMM	
LOG Plot	PN	IMM	IQ not supported	
Spot Freq	PN	IMM	IQ not supported	

GMSK PVT	EDGE/GSM	RFB	IMM	
GMSK PFER	EDGE/GSM	RFB	IQMag	
GMSK ORFS	EDGE/GSM	RFB	IQ not supported	
EDGE PVT	EDGE/GSM	RFB	IMM	
EDGE EVM	EDGE/GSM	RFB	IQMag	
EDGE ORFS	EDGE/GSM	RFB	IQ not supported	

RF Trigger Source

The **RF Trigger Source** command selects the trigger to be used for the specified measurement when RF is the selected input. The RF trigger source can be queried and changed even while another input is selected, but it is inactive until RF becomes the selected input.

Note the inclusion of the <measurement> parameter in the command below. Because each measurement remembers its own Trigger Source, the command must be qualified with the measurement name.

Remote Command:	<pre>:TRIGger:<measurement>[:SEquence]:RF:SOURce EXTernal1 EXTernal2 IMMediate LINE FRAMe RFBurst VIDeo IF ALARm LAN :TRIGger:<measurement>[:SEquence]:RF:SOURce?</pre>
Example:	<pre>TRIG:ACP:RF:SOUR EXT1 Selects the external 1 trigger input for the ACP measurement and the RF input TRIG:RF:SOUR VID</pre>

Common Measurement Functions 1

Notes:	<p>Not all measurements have all the trigger sources available to them. Check the trigger source documentation for your specific measurement to see what sources are available.</p> <p>Not all trigger sources are available for each input. For the RF Trigger Source, the following trigger sources are available:</p> <ul style="list-style-type: none"> — IMMEDIATE - free run triggering — VIDEO - triggers on the video signal level — LINE - triggers on the power line signal — EXTERNAL1 - triggers on an externally connected trigger source marked "Trigger 1 In" on the rear panel — EXTERNAL2 - triggers on an externally connected trigger source marked "Trigger 2 In" on the front panel. In some models, there is no second External input. In these models, the External 2 key is blanked and the EXTERNAL2 parameter will generate a "Hardware missing; Not available for this model number" error — RFBURST - triggers on the bursted frame — FRAME - triggers on the periodic timer — IF (video) - same as video, for backwards compatibility only — ALARM - LXI Alarm — LAN - LXI LAN event <p>*OPC should be used after requesting data. This will hold off any subsequent changes to the selected trigger source, until after the sweep is completed and the data is returned.</p> <p>Available ranges, and presets can vary from mode to mode.</p>
Status Bits/OPC dependencies:	<p>The Status Operation Register bit 5 "Waiting for Trigger" is set at the same time as the Sweeping or Measuring bit is set. It is cleared when the trigger actually occurs (that is, after the trigger event occurs and all the applicable trigger criteria have been met). A corresponding pop-up message ("Waiting for trigger") is generated if no trigger signal appears after approximately 2 sec. This message goes away when a trigger signal appears.</p>
Backwards Compatibility SCPI:	<p>In earlier instruments, the parameter IF was used by apps for the video trigger, so using the IF enum selects video triggering.</p> <p>Sending IF in the query returns the VID enum.</p>
Initial S/W Revision:	Prior to A.02.00
Help Map ID:	0

I/Q Trigger Source

This command selects the trigger to be used for the specified measurement when I/Q (which requires option BBA) is the selected input. The I/Q trigger source can be queried and changed even while another

input is selected, but it is inactive until I/Q becomes the selected input.

Remote Command:	:TRIGger:<measurement>[:SEquence]:IQ:SOURce EXTernal1 EXTernal2 IMMediate IQMag IDEMod QDEMod IINPut t QINPut AIQMag :TRIGger:<measurement>[:SEquence]:IQ:SOURce?
Example:	TRIG:WAVEform:SOUR IQM Selects I/Q magnitude triggering for the IQ Waveform measurement and the I/Q input
Notes:	<p>Not all measurements have all the trigger sources available to them. Check the trigger source documentation for your specific measurement to see what sources are available.</p> <p>Not all trigger sources are available for each input. For the I/Q Trigger Source, the following trigger sources are available:</p> <ul style="list-style-type: none"> — IMMediate - free run triggering — EXTernal1 - triggers on an externally connected trigger source on the rear panel — EXTernal2 - triggers on an externally connected trigger source on the front panel — IQMag - triggers on the magnitude of the I/Q signal — IDEMod - triggers on the I/Q signal's demodulated I voltage — QDEMod - triggers on the I/Q signal's demodulated Q voltage — IINPut - triggers on the I channel's ADC voltage — QINPut - triggers on the Q channel's ADC voltage — AIQMag - triggers on the magnitude of the auxiliary receiver channel I/Q signal <p>*OPC should be used after requesting data. This will hold off any subsequent changes to the selected trigger source, until after the sweep is completed and the data is returned.</p> <p>Available ranges, an from mode to mode.d presets can vary</p>
Status Bits/OPC dependencies:	The Status Operation Register bit 5 "Waiting for Trigger" is set at the same time as the Sweeping or Measuring bit is set. It is cleared when the trigger actually occurs (that is, after the trigger event occurs and all the applicable trigger criteria have been met). A corresponding pop-up message ("Waiting for trigger") is generated if no trigger signal appears after approximately 2 sec. This message goes away when a trigger signal appears.
Initial S/W Revision:	Prior to A.02.00
Help Map ID:	0

More Information

The trigger menus let you select the trigger source and trigger settings for a sweep or measurement. In

Common Measurement Functions 1

triggered operation (basically, any trigger source other than Free Run), the test set begins a sweep or measurement only with the selected trigger conditions are met, generally when your trigger source signal meets the specified trigger level and polarity requirements. (In FFT measurements, the trigger controls when the data acquisition begins for FFT conversion.)

For each of the trigger sources, you may define a set of operational parameters or settings which are applied when that source is selected as the current trigger source. Examples of these settings are Trigger Level, Trigger Delay, and Trigger Slope. You may apply different settings for each source; so, for example, you could have a Trigger Level of 1 v for External 1 trigger and -10 dBm for Video trigger.

Once you have established the settings for a given trigger source, they generally remain unchanged for that trigger source as you go from measurement to measurement within a Mode (although the settings do change as you go from Mode to Mode). Furthermore, the trigger settings within a Mode are the same for the **Trigger** menu, the **Gate Source** menu, and the **Sync Source** menu that is part of the **Periodic Timer Trigger Setup** menu. That is, if **Ext1** trigger level is set to 1 v in the **Trigger** menu, it will appear as 1 v in both the **Gate Source** and the **Sync Source** menus. For these reasons the trigger settings commands are not qualified with the measurement name, the way the trigger source commands are.

The settings setup menu can be accessed by pressing the key for the current trigger source a second time. For example, one press of Video selects the Video trigger as the source. The Video key becomes highlighted and the hollow arrow on the key turns black. Now a second press of the key takes you into the Video Trigger Setup menu.

Trigger Setup Parameters:

The following examples show trigger setup parameters using an external trigger source.

Example 1 illustrates the trigger conditions with negative slope and no trigger occurs during trigger Holdoff time.

Example 2 illustrates the trigger conditions with positive slope, trigger delay, and auto trigger time.

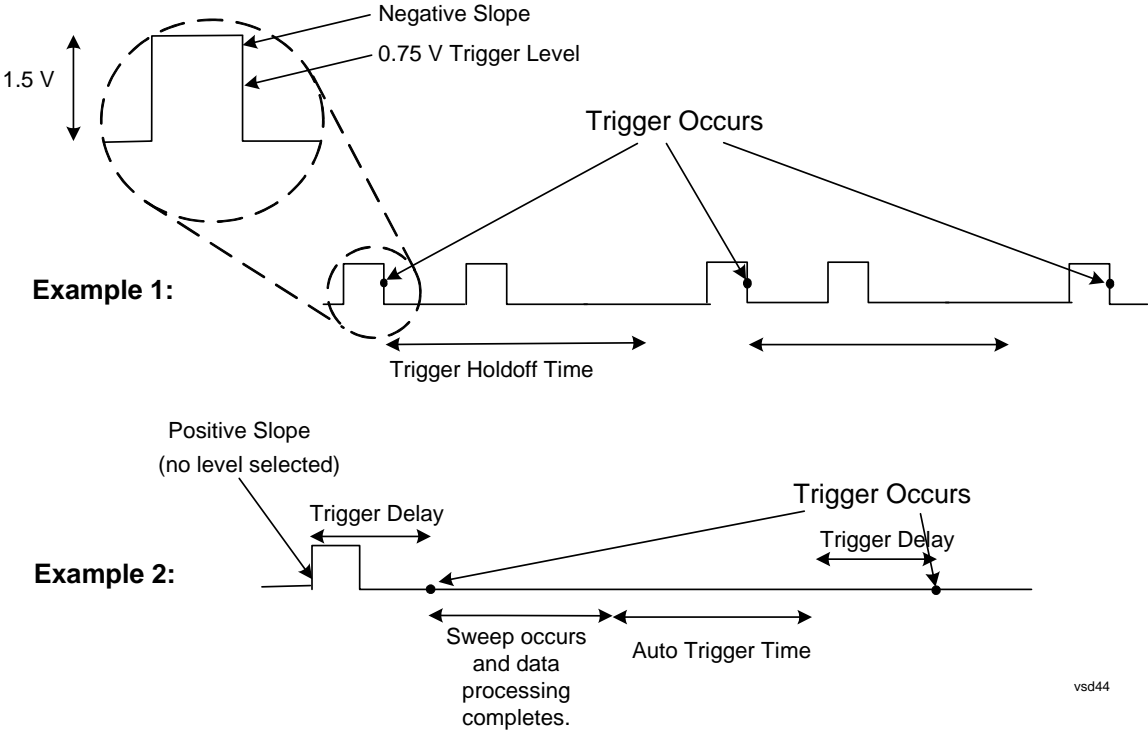

Free Run

Pressing this key, when it is not selected, selects free-run triggering. Free run triggering occurs immediately after the sweep/measurement is initiated.

Key Path	Trigger
Example	TRIG:SOUR IMM Swept SA measurement TRIG:<meas>:SOUR IMM Measurements other than Swept SA
State Saved	Saved in instrument state
Status Bits/OPC dependencies	The Status Operation Register bit 5 "Waiting for Trigger" is set at the same time as the Sweeping or Measuring bit is set. It is cleared when the trigger actually occurs (that is, after the trigger event occurs and all the applicable trigger criteria have been met). A corresponding pop-up message ("Waiting for trigger") is generated if no trigger signal appears after approximately 2 sec. This message goes away when a trigger signal appears.
Initial S/W Revision	Prior to A.02.00
Help Map ID	3373

Video (IF Envelope)

Pressing this key, when it is not selected, selects the video signal as the trigger. The Video trigger condition is met when the video signal (the filtered and detected version of the input signal, including both RBW and VBW filtering) crosses the video trigger level.

Common Measurement Functions 1

NOTE When the detector selected for all active traces is the average detector, the video signal for triggering does not include any VBW filtering.

The video trigger level is shown as a labeled line on the display. The line is displayed as long as video is the selected trigger source.

Pressing this key, when it is already selected, accesses the video trigger setup functions.

Key Path	Trigger
Example	TRIG:SOUR VID Swept SA measurement TRIG:<meas>:SOUR VID Measurements other than Swept SA
Notes	Log Plot and Spot Frequency measurements do not support Video Trigger
Dependencies	Video trigger is allowed in average detector mode.
State Saved	Saved in instrument state
Status Bits/OPC dependencies	The Status Operation Register bit 5 "Waiting for Trigger" is set at the same time as the Sweeping or Measuring bit is set. It is cleared when the trigger actually occurs (that is, after the trigger event occurs and all the applicable trigger criteria have been met). A corresponding pop-up message ("Waiting for trigger") is generated if no trigger signal appears after approximately 2 sec. This message goes away when a trigger signal appears.
Initial S/W Revision	Prior to A.02.00
Help Map ID	3374

Trigger Level

Sets a level for the video signal trigger. When the video signal crosses this level, with the chosen slope, the trigger occurs. This level is displayed with a horizontal line only if **Video** is the selected trigger source.

Remote Command	:TRIGger[:SEQuence]:VIDeo:LEVel <ampl> :TRIGger[:SEQuence]:VIDeo:LEVel?
Example	TRIG:VID:LEV -40 dBm
Default Unit	depends on the current selected Y axis unit
Initial S/W Revision	Prior to A.02.00
Key Path	Trigger, Video

Notes	<p>When sweep type = FFT, the video trigger uses the amplitude envelope in a bandwidth wider than the FFT width as a trigger source. This might often be useful, but does not have the same relationship between the displayed trace and the trigger level as in swept triggering.</p> <p>Amplitude Corrections are not taken into account by the Video Trig Level. For example, if you have given yourself effective gain with an amplitude correction factor, the Video Trigger will not fire until you have dropped the trigger line that far below the displayed signal level, rather than simply dropping it down to the displayed signal level.</p> <p>Note that other corrections, specifically External Gain and Ref Level Offset, modify the actual trace data as it is taken and therefore ARE taken into account by Trig Level.</p>
Couplings	This same level is used for the Video trigger source in the Trigger menu and for the Video selection in the Gate Source menu.
Preset	Set the Video Trigger Level –25 dBm on Preset. When the Video Trigger Level becomes the active function, if the value is off screen, set it to either the top or bottom of screen, depending on which direction off screen it was.
State Saved	Saved in instrument state
Min	–170 dBm
Max	+30 dBm
Backwards Compatibility SCPI	:TRIGger[:SEQuence]:IF:LEVel :TRIGger[:SEQuence]:IF:LEVel?
Help Map ID	3375

Trig Slope

Controls the trigger polarity. It is set positive to trigger on a rising edge and negative to trigger on a falling edge.

Key Path	Trigger, Video
Remote Command	:TRIGger[:SEQuence]:VIDeo:SLOPe POSitive NEGative :TRIGger[:SEQuence]:VIDeo:SLOPe?
Example	TRIG:VID:SLOP NEG
Preset	POSitive
State Saved	Saved in instrument state
Backwards Compatibility SCPI	:TRIGger[:SEQuence]:SLOPe :TRIGger[:SEQuence]:IF:SLOPe

Common Measurement Functions 1

Backwards Compatibility SCPI	<p>For backward compatibility, the following commands should update all instances of trigger slope (video/external/line). The query returns the trigger slope setting of the selected trigger source.</p> <pre>:TRIGger[:SEquence]:SLOPe POSitive NEGative</pre> <pre>:TRIGger[:SEquence]:SLOPe?</pre> <p>For backward compatibility with VSA/PSA comms apps, we need to alias</p> <pre>:TRIGger[:SEquence]:IF:SLOPe NEGative POSitive</pre> <pre>:TRIGger[:SEquence]:IF:SLOPe?</pre>
Initial S/W Revision	Prior to A.02.00
Help Map ID	3377

Trig Delay

Controls a time delay during that the test set waits to begin a sweep after meeting the trigger criteria. You can use negative delay to pre-trigger the instrument in the time domain or FFT, but not in swept spans.

Key Path	Trigger, Video
Remote Command	<pre>:TRIGger[:SEquence]:VIDeo:DELAy <time></pre> <pre>:TRIGger[:SEquence]:VIDeo:DELAy?</pre> <pre>:TRIGger[:SEquence]:VIDeo:DELAy:STATe OFF ON 0 1</pre> <pre>:TRIGger[:SEquence]:VIDeo:DELAy:STATe?</pre>
Example	<pre>TRIG:VID:DEL:STAT ON</pre> <pre>TRIG:VID:DEL 100 ms</pre>
Notes	<p>Video trigger delay may be set to negative values, in time domain, FFT and even swept. It makes intuitive sense in time domain and works well in FFT mode where the bandwidth of the filter before the video trigger is about 1.25 span. In swept spans, negative settings of Trig Delay are treated as a zero setting within the internal hardware and the advisory message "Neg. Trig Delay unavailable in Swept Mode, zero delay used." is generated when such a delay is set.</p>
Preset	Off, 1 us
State Saved	Saved in instrument state
Min	-150 ms
Max	+500 ms
Default Unit	s
Backwards Compatibility SCPI	<pre>:TRIGger[:SEquence]:IF:DELAy</pre> <pre>:TRIGger[:SEquence]:DELAy</pre>

Backwards Compatibility SCPI	<p>For backward compatibility with VSA/PSA comms apps, we need to alias Video trigger to</p> <pre>:TRIGger[:SEQuence]:IF:DELAy <time></pre> <pre>:TRIGger[:SEQuence]:IF:DELAy?</pre> <p>For backward compatibility, the following commands should update all instances of trigger delay (not including RF Burst). The query returns the video trigger delay settings of the selected trigger source.</p> <pre>:TRIGger[:SEQuence]:DELAy <time></pre> <pre>:TRIGger[:SEQuence]:DELAy?</pre> <pre>:TRIGger[:SEQuence]:DELAy:STATe OFF ON 0 1</pre> <pre>:TRIGger[:SEQuence]:DELAy:STATe?</pre>
Initial S/W Revision	Prior to A.02.00
Help Map ID	3378

Line

Pressing this key, when it is not selected, selects the line signal as the trigger. A new sweep/measurement will start synchronized with the next cycle of the line voltage. Pressing this key, when it is already selected, access the line trigger setup menu.

Key Path	Trigger
Example	TRIG:<meas>:SOUR LINE
Dependencies	Line trigger is not available when operating from a "dc power source", for example, when the instrument is powered from batteries.
State Saved	Saved in instrument state
Status Bits/OPC dependencies	The Status Operation Register bit 5 "Waiting for Trigger" is set at the same time as the Sweeping or Measuring bit is set. It is cleared when the trigger actually occurs (that is, after the trigger event occurs and all the applicable trigger criteria have been met). A corresponding pop-up message ("Waiting for trigger") is generated if no trigger signal appears after approximately 2 sec. This message goes away when a trigger signal appears.
Initial S/W Revision	Prior to A.02.00
Help Map ID	3379

Trig Slope

Controls the trigger polarity. It is set positive to trigger on a rising edge and negative to trigger on a falling edge.

Key Path	Trigger, Line
----------	----------------------

Common Measurement Functions 1

Remote Command	:TRIGger[:SEQuence]:LINE:SLOPe POSitive NEGative :TRIGger[:SEQuence]:LINE:SLOPe?
Example	TRIG:LINE:SLOP NEG
Preset	POSitive
State Saved	Saved in instrument state
Backwards Compatibility SCPI	:TRIGger[:SEQuence]:SLOPe (There are SLOPe backward compatibility commands.)
Initial S/W Revision	Prior to A.02.00
Help Map ID	3380

Trig Delay

Controls a time delay during which the test set waits to begin a sweep after meeting the trigger criteria. You can use negative delay to pre-trigger the instrument in time domain or FFT, but not in swept spans.

Key Path	Trigger, Line
Remote Command	:TRIGger[:SEQuence]:LINE:DELAy <time> :TRIGger[:SEQuence]:LINE:DELAy? :TRIGger[:SEQuence]:LINE:DELAy:STATE OFF ON 0 1 :TRIGger[:SEQuence]:LINE:DELAy:STATE?
Example	TRIG:LINE:DEL:STAT ON TRIG:LINE:DEL 100 ms
Notes	Video trigger delay may be set to negative values, in time domain, FFT and even swept. It makes intuitive sense in time domain and works well in FFT mode where the bandwidth of the filter before the video trigger is about 1.25 span. In swept spans, negative settings of Trig Delay are treated as a zero setting within the internal hardware and the advisory message "Neg. Trig Delay unavailable in Swept Mode, zero delay used." is generated when such a delay is set.
Preset	Off, 1.000 us
State Saved	Saved in instrument state
Min	-150 ms
Max	500 ms
Default Unit	S
Backwards Compatibility SCPI	There are DELay backward compatibility commands described in video, Section " Trig Delay " on page 1714) :TRIGger[:SEQuence]:DELAy
Initial S/W Revision	Prior to A.02.00

Help Map ID	3381
-------------	------

External 1

Pressing this key, when it is not selected, selects an external input signal as the trigger. A new sweep/measurement will start when the external trigger condition is met using the external 1 input connector on the rear panel.

Pressing this key, when it is already selected, accesses the external 1 trigger setup menu.

Key Path	Trigger
Example	TRIG:SOUR EXT1 Swept SA measurement TRIG:<meas>:SOUR EXT1 Measurements other than Swept SA
State Saved	Saved in instrument state
Status Bits/OPC dependencies	The Status Operation Register bit 5 "Waiting for Trigger" is set at the same time as the Sweeping or Measuring bit is set. It is cleared when the trigger actually occurs (that is, after the trigger event occurs and all the applicable trigger criteria have been met). A corresponding pop-up message ("Waiting for trigger") is generated if no trigger signal appears after approximately 2 sec. This message goes away when a trigger signal appears.
Initial S/W Revision	Prior to A.02.00
Help Map ID	3382

Trigger Level

Sets the value where the external 1 trigger input will trigger a new sweep/measurement.

Key Path	Trigger, External 1
Remote Command	:TRIGger[:SEquence]:EXTernal1:LEVel <level> :TRIGger[:SEquence]:EXTernal1:LEVel?
Example	TRIG:EXT1:LEV 0.4 V
Couplings	This same level is used for the Ext1 trigger source in the Trigger menu, for the Ext1 selection in the Periodic Timer sync source (in the Trigger menu and in the Gate Source menu), and also for the Ext1 selection in the Gate Source menu.
Preset	1.2 V
State Saved	Saved in instrument state
Min	-5 V
Max	5 V
Default Unit	V

Common Measurement Functions 1

Backwards Compatibility SCPI	:TRIGger[:SEQuence]:EXTernal:LEVel (For backward compatibility, EXTernal should also work.)
Initial S/W Revision	Prior to A.02.00
Help Map ID	3383

Trig Slope

Controls the trigger polarity. It is set positive to trigger on a rising edge and negative to trigger on a falling edge.

Key Path	Trigger, External 1
Remote Command	:TRIGger[:SEQuence]:EXTernal1:SLOPe POSitive NEGative :TRIGger[:SEQuence]:EXTernal1:SLOPe?
Example	TRIG:EXT1:SLOP NEG
Couplings	This same slope is used in the Ext1 selection for the trigger source in the Trigger menu and for the period timer sync source (in the Trigger menu and in the Gate Source menu).
Preset	POSitive
State Saved	Saved in instrument state
Backwards Compatibility SCPI	For backward compatibility, EXTernal should also work. Also, there are SLOPe backward compatibility commands described in Video section “Trig Slope” on page 1713 :TRIGger[:SEQuence]:SLOPe
Initial S/W Revision	Prior to A.02.00
Help Map ID	3384

Trig Delay

Controls a time delay during which the test set waits to begin a sweep after meeting the trigger criteria. You can use negative delay to pre-trigger the instrument in time domain or FFT, but not in swept spans.

Key Path	Trigger, External 1
Remote Command	:TRIGger[:SEQuence]:EXTernal1:DELay <time> :TRIGger[:SEQuence]:EXTernal1:DELay? :TRIGger[:SEQuence]:EXTernal1:DELay:STATe OFF ON 0 1 :TRIGger[:SEQuence]:EXTernal1:DELay:STATe?
Example	TRIG:EXT1:DEL:STAT ON TRIG:EXT1:DEL 100 ms

Notes	Video trigger delay may be set to negative values, in time domain, FFT and even swept. It makes intuitive sense in time domain and works well in FFT mode where the bandwidth of the filter before the video trigger is about 1.25 span. In swept spans, negative settings of Trig Delay are treated as a zero setting within the internal hardware and the advisory message "Neg. Trig Delay unavailable in Swept Mode, zero delay used." is generated when such a delay is set.
Preset	Off, 1.000 us
State Saved	Saved in instrument state
Min	-150 ms
Max	+500 ms
Default Unit	s
Backwards Compatibility SCPI	For backward compatibility, EXTERNAL should also work. Also, there are DELAY backward compatibility commands described in video section " Trig Delay " on page 1714 :TRIGGER[:SEQUENCE]:DELAY
Initial S/W Revision	Prior to A.02.00
Help Map ID	3385

External 2

Pressing this key, when it is not selected, selects an external input signal as the trigger. A new sweep/measurement will start when the external trigger condition is met using the external 2 input connector. The external trigger 2 input connector is on the rear panel.

Pressing this key, when it is already selected, accesses the external 2 trigger setup menu.

Key Path	Trigger
Example	TRIG:<meas>:SOUR EXT2
Dependencies	In some models, there is no second External input. In these models, the External 2 key is blanked and the EXTERNAL2 parameter will generate a "Hardware missing; Not available for this model number" error
State Saved	Saved in instrument state
Status Bits/OPC dependencies	The Status Operation Register bit 5 "Waiting for Trigger" is set at the same time as the Sweeping or Measuring bit is set. It is cleared when the trigger actually occurs (that is, after the trigger event occurs and all the applicable trigger criteria have been met). A corresponding pop-up message ("Waiting for trigger") is generated if no trigger signal appears after approximately 2 sec. This message goes away when a trigger signal appears.
Initial S/W Revision	Prior to A.02.00
Modified at S/W Revision	A.03.00

Common Measurement Functions 1

Help Map ID	3386
-------------	------

Trigger Level

Sets the value where the external 2 trigger input will trigger a new sweep/measurement.

Key Path	Trigger, External 2
Remote Command	:TRIGger[:SEquence]:EXTernal2:LEVEl :TRIGger[:SEquence]:EXTernal2:LEVEl?
Example	TRIG:EXT2:LEV 1.1 V
Couplings	This same level is used for the Ext2 trigger source in the Trigger menu, for the Ext2 selection in the Periodic Timer sync source (in the Trigger menu and in the Gate Source menu), and also for the Ext2 selection in the Gate Source menu.
Preset	1.2 V
State Saved	Saved in instrument state
Min	-5 V
Max	5 V
Default Unit	V
Initial S/W Revision	Prior to A.02.00
Help Map ID	3387

Trig Slope

Controls the trigger polarity. It is set positive to trigger on a rising edge and negative to trigger on a falling edge.

Key Path	Trigger, External 2
Remote Command	:TRIGger[:SEquence]:EXTernal2:SLOPe POSitive NEGative :TRIGger[:SEquence]:EXTernal2:SLOPe?
Example	TRIG:EXT2:SLOP NEG
Couplings	This same slope is used in the Ext2 selection for the trigger source in the Trigger menu and for the period timer sync source (in the Trigger menu and in the Gate Source menu).
Preset	POSitive
State Saved	Saved in instrument state
Backwards Compatibility SCPI	Also, there are SLOPe backward compatibility commands described in Video, section :TRIGger[:SEquence]:SLOPe
Initial S/W Revision	Prior to A.02.00

Help Map ID

3388

Trig Delay

Controls a time delay during which the test set waits to begin a sweep after meeting the trigger criteria. You can use negative delay to pre-trigger the instrument in time domain or FFT, but not in swept spans.

Key Path	Trigger, External 2
Remote Command	:TRIGger[:SEquence]:EXTernal2:DElay <time> :TRIGger[:SEquence]:EXTernal2:DElay? :TRIGger[:SEquence]:EXTernal2:DElay:STATE OFF ON 0 1 :TRIGger[:SEquence]:EXTernal2:DElay:STATE?
Example	TRIG:EXT2:DEL:STAT ON TRIG:EXT2:DEL 100 ms
Notes	Video trigger delay may be set to negative values, in time domain, FFT and even swept. It makes intuitive sense in time domain and works well in FFT mode where the bandwidth of the filter before the video trigger is about 1.25 span. In swept spans, negative settings of Trig Delay are treated as a zero setting within the internal hardware and the advisory message "Neg. Trig Delay unavailable in Swept Mode, zero delay used." is generated when such a delay is set.
Preset	Off, 1.000 us
State Saved	Saved in instrument state
Min	-150 ms
Max	500 ms
Default Unit	s
Backwards Compatibility SCPI	Also, there are DELay backward compatibility commands described in video section " Trig Delay " on page 1714. :TRIGger[:SEquence]:DElay
Initial S/W Revision	Prior to A.02.00
Help Map ID	3389

RF Burst

Pressing this key, when it is not selected, selects the RF Burst as the trigger. A new sweep/measurement will start when an RF burst envelope signal is identified from the signal at the RF Input connector. Pressing this key, when it is already selected, accesses the RF Burst trigger setup menu.

In some models, a variety of burst trigger circuitry is available, resulting in various available burst trigger bandwidths. The test set automatically chooses the appropriate trigger path based on the hardware

Common Measurement Functions 1

configuration and other settings of the test set.

Key Path	Trigger
Example	TRIG:SOUR RFB Swept SA measurement TRIG:<meas>:SOUR RFB Measurements other than Swept SA
State Saved	Saved in instrument state
Status Bits/OPC dependencies	The Status Operation Register bit 5 "Waiting for Trigger" is set at the same time as the Sweeping or Measuring bit is set. It is cleared when the trigger actually occurs (that is, after the trigger event occurs and all the applicable trigger criteria have been met). A corresponding pop-up message ("Waiting for trigger") is generated if no trigger signal appears after approximately 2 sec. This message goes away when a trigger signal appears.
Initial S/W Revision	Prior to A.02.00
Modified at S/W Revision	A.04.00
Help Map ID	3390

Absolute Trigger Level

Sets the absolute trigger level for the RF burst envelope.

Remote Command	:TRIGger[:SEquence]:RFBurst:LEVel:ABSolute <ampl> :TRIGger[:SEquence]:RFBurst:LEVel:ABSolute?
Example	TRIG:RFB:LEV:ABS 10 dBm sets the trigger level of the RF burst envelope signal to the absolute level of 10 dBm
Default Unit	depends on the current selected Y-Axis unit
Initial S/W Revision	Prior to A.02.00
Key Path	Trig, RF Burst
Scope	Meas Global
Notes	Sending this command does not switch the setting from relative to absolute; to switch it you need to send the :TRIGger[:SEquence]:RFBurst:LEVel:TYPE command, below. Amplitude Corrections are not taken into account by the Absolute Trigger Level. For example, if you have given yourself effective gain with an amplitude correction factor, the Absolute Trigger will not fire until you have set the trigger level that far below the displayed signal level, rather than simply to the displayed signal level. This is only true for Amplitude Corrections, not External Gain or Ref Level Offset functions.

Couplings	This same level is used for the RF Burst trigger source in the Trigger menu, for the RF Burst selection in the Periodic Timer sync source (in the Trigger menu and in the Gate Source menu), and also for the RF Burst selection in the Gate Source menu
Preset	-20 dBm
State Saved	Saved in state
Min	-200 dBm
Max	100 dBm
Modified at S/W Revision	A.04.00
Help Map ID	3391

Remote Command:	:TRIGger [:SEquence] :RFBurst :LEVel :TYPE ABSolute RELative :TRIGger [:SEquence] :RFBurst :LEVel :TYPE?
Example:	TRIG:RFB:LEV:TYPE REL sets the trigger level type of the RF burst trigger to Relative.
Preset:	ABSolute
State Saved:	Saved in State
Key Path:	Trig, RF Burst
Initial S/W Revision:	Prior to A.02.00
Modified at S/W Revision:	A.04.00
Help Map ID:	0

Relative Trigger Level

Sets the relative trigger level for the RF burst envelope.

In some models, the relative burst trigger function is implemented in hardware. In other models, without the advanced triggering hardware required, the relative burst trigger function is implemented in software in some measurements, and is unavailable in other measurements.

When implemented in software, the relative RF Burst trigger function is implemented as follows:

The measurement starts with the absolute RF Burst trigger setting. If it can not get a trigger with that level, auto trigger fires and the acquisition starts anyway. After the acquisition, the measurement searches for the peak in the acquired waveform and saves it.

Now, in the next cycle of the measurement, the measurement determines a new absolute RF Burst level based on the peak value from the first measurement and the Relative RF Burst Trigger Level (always 0 or negative dB) set by the user. The following formula is used:

$$\text{absolute RF Burst level} = \text{peak level of the previous acquisition} + \text{relative RF Burst level}$$

Common Measurement Functions 1

If the new absolute RF Burst level differs from the previous by more than 0.5 dB, the new level is sent to the hardware; otherwise it is not updated (to avoid slowing down the acquisition)

Steps 2 and 3 repeat for subsequent measurements.

Remote Command	<code>:TRIGger[:SEquence]:RFBurst:LEVel:RELative <rel_ampl></code> <code>:TRIGger[:SEquence]:RFBurst:LEVel:RELative?</code>
Example	TRIG:RFB:LEV:REL -10 dB sets the trigger level of the RF burst envelope signal to the relative level of -10 dB
Default Unit	dB or dBc
Initial S/W Revision	Prior to A.02.00
Key Path	Trig, RF Burst
Scope	Meas Global
Notes	Sending this command does not switch the setting from absolute to relative; to switch it you need to send the <code>:TRIGger[:SEquence]:RFBurst:LEVel:TYPE</code> command, above. The relative trigger level is not available in some measurements. In those measurements the RELative parameter, and the <code>:TRIGger[:SEquence]:RFBurst:LEVel:TYPE</code> command (above), should generate an error if sent.
Dependencies	This key is grayed out and Absolute Trigger Level selected if the required hardware is not present in your test set and the current measurement does not support Relative triggering.
Preset	-6 dB GSM: -25 dB
State Saved	Saved in state
Min	-45 dB
Max	0 dB
Backwards Compatibility SCPI	<code>:TRIGger[:SEquence]:RFBurst:LEVel</code> Is aliased to: <code>:TRIGger[:SEquence]:RFBurst:LEVel:RELative</code> because the PSA had ONLY relative burst triggering
Modified at S/W Revision	A.04.00
Help Map ID	4034

Trigger Slope

It is set positive to trigger on a rising edge and negative to trigger on a falling edge.

Key Path	Trigger, RF Burst
Remote Command	:TRIGger[:SEQuence]:RFBurst:SLOPe POSitive NEGative :TRIGger[:SEQuence]:RFBurst:SLOPe?
Example	TRIG:RFB:SLOP NEG
Couplings	This same slope is used in the RF Burst selection for the trigger source in the Trigger menu and for the period timer sync source (in the Trigger menu and in the Gate Source menu).
Preset	POSitive
State Saved	Saved in instrument state
Backwards Compatibility SCPI	Also, there are SLOPe backward compatibility commands described in Video section “Trig Slope” on page 1713 :TRIGger[:SEQuence]:SLOPe
Initial S/W Revision	Prior to A.02.00
Help Map ID	3394

Trig Delay

Controls a time delay during which the test set waits to begin a sweep after meeting the trigger criteria. You can use negative delay to pre-trigger the instrument in time domain or FFT, but not in swept spans.

Key Path	Trigger, RF Burst
Remote Command	:TRIGger[:SEQuence]:RFBurst:DELAy <time> :TRIGger[:SEQuence]:RFBurst:DELAy? :TRIGger[:SEQuence]:RFBurst:DELAy:STATe OFF ON 0 1 :TRIGger[:SEQuence]:RFBurst:DELAy:STATe?
Example	TRIG:RFB:DEL:STAT ON TRIG:RFB:DEL 100 ms
Notes	Video trigger delay may be set to negative values, in time domain, FFT and even swept. It makes intuitive sense in time domain and works well in FFT mode where the bandwidth of the filter before the video trigger is about 1.25 span. In swept spans, negative settings of Trig Delay are treated as a zero setting within the internal hardware and the advisory message "Neg. Trig Delay unavailable in Swept Mode, zero delay used." is generated when such a delay is set.
Preset	Off, 1.000 us
State Saved	Saved in instrument state
Min	-150 ms

Common Measurement Functions 1

Max	500 ms
Default Unit	s
Backwards Compatibility SCPI	Also, there are DELay backward compatibility commands described in video section “ Trig Delay ” on page 1714. :TRIGger[:SEQuence]:DELay
Initial S/W Revision	Prior to A.02.00
Help Map ID	3395

Periodic Timer (Frame Trigger)

Pressing this key, when it is not selected, selects the internal periodic timer signal as the trigger. Triggering occurrences are set by the **Period** parameter, which is modified by the **Sync Source** and **Offset**. Pressing this key, when it is already selected, accesses the periodic timer trigger setup functions.

If you do not have a sync source selected (it is Off), then the internal timer will not be synchronized with any external timing events.

Key Path	Trigger
Example	TRIG:SOUR FRAM Swept SA measurement TRIG:<meas>:SOUR FRAM Measurements other than Swept SA
State Saved	Saved in instrument state
Readback	[Sync: <value of Sync Source>], for example, [Sync: External 1]
Status Bits/OPC dependencies	The Status Operation Register bit 5 "Waiting for Trigger" is set at the same time as the Sweeping or Measuring bit is set. It is cleared when the trigger actually occurs (that is, after the trigger event occurs and all the applicable trigger criteria have been met). A corresponding pop-up message ("Waiting for trigger") is generated if no trigger signal appears after approximately 2 sec. This message goes away when a trigger signal appears.
Initial S/W Revision	Prior to A.02.00
Help Map ID	3397

Periodic Timer Triggering:

This feature selects the internal periodic timer signal as the trigger. Trigger occurrences are set by the **Periodic Timer** parameter, which is modified by the **Sync Source** and **Offset**.

The figure below shows the action of the periodic timer trigger. Before reviewing the figure, we'll explain some uses for the periodic trigger.

A common application is measuring periodic burst RF signals for which a trigger signal is not easily available. For example, we might be measuring a TDMA radio which bursts every 20 ms. Let's assume that the 20 ms period is very consistent. Let's also assume that we do not have an external trigger source available that is synchronized with the period, and that the signal-to-noise ratio of the signal is not high enough to provide a clean RF burst trigger at all of the analysis frequencies. For example, we might want to measure spurious transmissions at an offset from the carrier that is larger than the bandwidth of the RF

burst trigger. In this application, we can set the Periodic Timer to a 20.00 ms period and adjust the offset from that timer to position our trigger just where we want it. If we find that the 20.00 ms is not exactly right, we can adjust the period slightly to minimize the drift between the period timer and the signal to be measured.

A second way to use this feature would be to use **Sync Source** temporarily, instead of **Offset**. In this case, we might tune to the signal in a narrow span and use the RF Burst trigger to synchronize the periodic timer. Then we would turn the sync source off so that it would not mis-trigger. Mis-triggering can occur when we are tuned so far away from the RF burst trigger that it is no longer reliable.

A third example would be to synchronize to a signal that has a reference time element of much longer period than the period of interest. In some CDMA applications, it is useful to look at signals with a short periodicity, by synchronizing that periodicity to the "even-second clock" edge that happens every two seconds. Thus, we could connect the even-second clock trigger to Ext1 and use then Ext1 as the sync source for the periodic timer.

The figure below illustrates this third example. The top trace represents the even-second clock. It causes the periodic timer to synchronize with the leading edge shown. The test set trigger occurs at a time delayed by the accumulated offset from the period trigger event. The periodic timer continues to run, and triggers continue to occur, with a periodicity determined by the test set time base. The timer output (labeled "late event") will drift away from its ideal time due to imperfect matching between the time base of the signal being measured and the time base of the test set, and also because of imperfect setting of the period parameter. But the synchronization is restored on the next even-second clock event.

("Accumulated offset" is described in the in the **Offset** function section.)

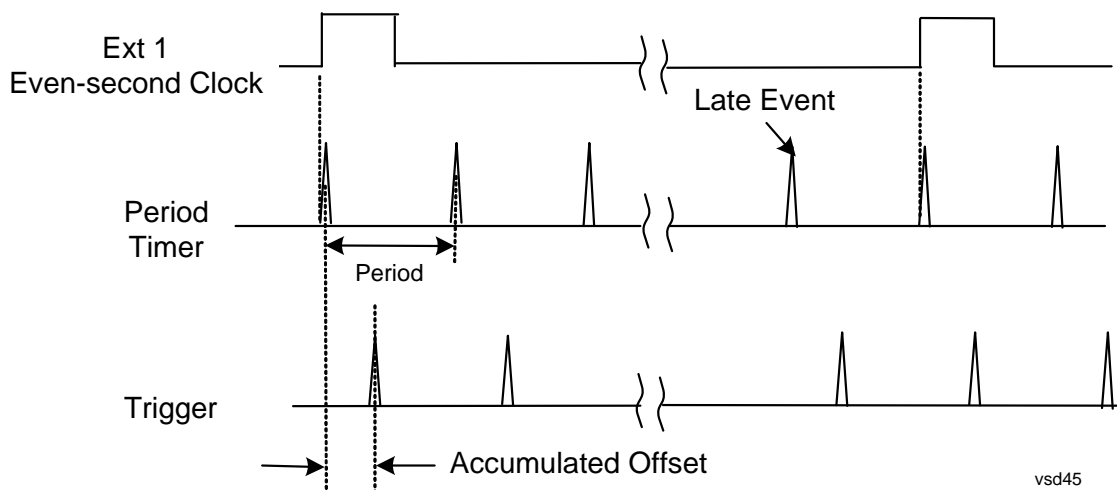

Period

Sets the period of the internal periodic timer clock. For digital communications signals, this is usually set to the frame period of your current input signal. In the case that sync source is not set to OFF, and the external sync source rate is changed for some reason, the periodic timer is synchronized at the every external synchronization pulse by resetting the internal state of the timer circuit.

Key Path	Trigger, Periodic Timer
Remote Command	:TRIGger[:SEquence]:FRAMe:PERiod <time> :TRIGger[:SEquence]:FRAMe:PERiod?

Common Measurement Functions 1

Example	TRIG:FRAM:PER 100 ms
Dependencies	The invalid data indicator turns on when the period is changed, until the next sweep/measurement completes.
Couplings	The same period is used in the Gate Source selection of the period timer.
Preset	20 ms GSM: 4.615383
State Saved	Saved in instrument state
Min	100.000 ns
Max	559.0000 ms
Default Unit	S
Initial S/W Revision	Prior to A.02.00
Help Map ID	3398

Offset

Adjusts the accumulated offset between the periodic timer events and the trigger event. Adjusting the accumulated offset is different than setting an offset, and requires explanation.

The periodic timer is usually not synchronized with any external events, so the timing of its output events has no absolute meaning. Since the timing relative to external events (RF signals) is important, you need to be able to adjust (offset) it. However, you have no direct way to see when the periodic timer events occur. All that you can see is the trigger timing. When you want to adjust the trigger timing, you are changing the internal offset between the periodic timer events and the trigger event. Because the absolute value of that internal offset is unknown, we will just call that the accumulated offset. Whenever the Offset parameter is changed, you are changing that accumulated offset. You can reset the displayed offset using Reset Offset Display. Changing the display does not change the value of the accumulated offset, and you can still make additional changes to accumulated offset.

To avoid ambiguity, we define that an increase in the "offset" parameter, either from the knob or the SCPI adjust command, serves to delay the timing of the trigger event.

Key Path	Trigger, Periodic Timer
Remote Command	:TRIGger[:SEquence]:FRAMe:OFFSet <time> :TRIGger[:SEquence]:FRAMe:OFFSet?
Example	TRIG:FRAM:OFFS 1.2 ms

Notes	<p>The front panel interface (for example, the knob), and this command, adjust the accumulated offset, which is shown on the active function display. However, the actual amount sent to the hardware each time the offset is updated is the delta value, that is, the current accumulated offset value minus the previous accumulated offset value. Note that the accumulated offset value is essentially arbitrary; it represents the accumulated offset from the last time the offset was zeroed (with the Reset Offset Display key).</p> <p>Note that this command does not change the period of the trigger waveform. Note also that Offset is used only when the sync source is set to OFF, otherwise delay is used, see “Trig Delay” on page 1733.</p> <p>An increase in the "offset" parameter, either from the knob or the SCPI adjust command, serves to delay the timing of the trigger event.</p>
Notes	<p>When the SCPI command is sent the value shown on the key (and the Active Function, if this happens to be the active function) is updated with the new value. However, the actual amount sent to the hardware is the delta value, that is, the current accumulated offset value minus the previous accumulated offset value.</p> <p>The SCPI query simply returns the value currently showing on the key.</p>
Dependencies	The invalid data indicator turns on when the offset is changed, until the next sweep/measurement completes.
Couplings	The same offset is used in the Gate Source selection of the period timer.
Preset	0 s
State Saved	Saved in instrument state
Min	-10.000 s
Max	10.000 s
Default Unit	S
Initial S/W Revision	Prior to A.02.00
Help Map ID	3399

Offset Adjust (Remote Command Only)

This remote command does not work at all like the related front panel keys. This command lets you advance the phase of the frame trigger by the amount you specify.

It does not change the period of the trigger waveform. If the command is sent multiple times, it advances the phase of the frame trigger an additional amount each time it is sent. Negative numbers are permitted.

Remote Command:	:TRIGger[:SEQuence]:FRAMe:ADJust <time>
Example:	TRIG:FRAM:ADJ 1.2 ms

Common Measurement Functions 1

Notes:	Note also that Offset is used only when the sync source is set to OFF, otherwise delay is used, see “Trig Delay” on page 1733 An increase in the "offset" parameter, either from the knob or the SCPI adjust command, serves to delay the timing of the trigger event.
Notes:	The front panel interface (for example, the knob) and the :TRIG:FRAM:OFFS command adjust the accumulated offset, which is shown on the active function display. However, the actual amount sent to the hardware is the delta value, that is, the current offset value minus the previous offset value. When the SCPI command is sent the value shown on the key (and the Active Function, if this happens to be the active function) is updated by increasing it (or decreasing it if the value sent is negative) by the amount specified in the SCPI command. This is a "command only" SCPI command, with no query.
Dependencies:	The invalid data indicator turns on when the offset is changed, until the next sweep/measurement completes.
Couplings:	The same offset is used in the Gate Source selection of the period timer.
Preset:	0 s
State Saved:	Saved in instrument state
Min:	-10.000 s
Max:	10.000 s
Default Unit:	S
Initial S/W Revision:	Prior to A.02.00
Help Map ID:	0

Reset Offset Display

Resets the value of the periodic trigger offset display setting to 0.0 seconds. The current displayed trigger location may include an offset value defined with the **Offset** key. Pressing this key redefines the currently displayed trigger location as the new trigger point that is 0.0 s offset. The **Offset** key can then be used to add offset relative to this new timing.

Key Path	Trigger, Periodic Timer
Remote Command	:TRIGger[:SEQUence]:FRAMe:OFFSet:DISPlay:RESet
Example	TRIG:FRAM:OFFS:DISP:RES
Initial S/W Revision	Prior to A.02.00
Help Map ID	3400

Sync Source

Selects a signal source for you to synchronize your periodic timer trigger to, otherwise you are triggering at some arbitrary location in the frame. Synchronization reduces the precision requirements on the

setting of the period.

For convenience you may adjust the level and slope of the selected sync source in a conditional branch setup menu accessed from the Sync Source menu. Note that these settings match those in the **Trigger** and **Gate Source** menus; that is, each trigger source has only one value of level and slope, regardless of which menu it is accessed from.

Key Path	Trigger, Periodic Timer
Remote Command	:TRIGger[:SEquence]:FRAMe:SYNC EXTeRnal1 EXTeRnal2 RFBurst OFF :TRIGger[:SEquence]:FRAMe:SYNC?
Example	TRIG:FRAM:SYNC EXT2
Dependencies	In some models, there is no second External input. In these models, the External 2 key is blanked and the EXTeRnal2 parameter will generate a “Hardware missing; Not available for this model number” error
Preset	Off GSM/EDGE: RFBurst
State Saved	Saved in instrument state
Readback	The current setting is read back to this key and it is also Readback to the previous Periodic Timer trigger key.
Initial S/W Revision	Prior to A.02.00
Modified at S/W Revision	A.03.00
Help Map ID	3402

Off

Turns off the sync source for your periodic trigger. With the sync source off, the timing will drift unless the signal source frequency is locked to the test set frequency reference.

Key Path	Trigger, Periodic Timer, Sync Source
Example	TRIG:FRAM:SYNC OFF
Readback	Off
Initial S/W Revision	Prior to A.02.00
Help Map ID	3403

External 1

Pressing this key, when it is not selected, selects the external input port that you will use for the periodic trigger synchronization. Pressing this key, when it is already selected, accesses the external 1 sync source setup menu.

Key Path	Trigger, Periodic Timer, Sync Source
Example	TRIG:FRAM:SYNC EXT

Common Measurement Functions 1

Couplings	Same as External 1 trigger source.
Readback	External 1
Initial S/W Revision	Prior to A.02.00
Help Map ID	3404

Trigger Level

Sets the value where the signal at the external 1 trigger input will synchronize with the periodic timer trigger. This same level is used in the Ext1 trigger source in the Trigger menu. See [“Trigger Level” on page 1717](#) for information on this key and the SCPI command.

Trig Slope

Controls the trigger polarity. It is set positive to trigger on a rising edge and negative to trigger on a falling edge. This same value is used in the Ext1 trigger source in the Trigger menu. See [“Trig Slope” on page 1718](#) for information on this key and the SCPI command

External 2

Pressing this key, when it is not selected, selects the external input port that you will use for the periodic frame trigger synchronization.

Pressing this key, when it is already selected, accesses the external 2 sync source setup menu.

Key Path	Trigger, Periodic Timer, Sync Source
Example	TRIG:FRAM:SYNC EXT2
Dependencies	In some models, there is no second External input. In these models, the External 2 key is blanked and the EXTernal2 parameter will generate a “Hardware missing; Not available for this model number” error
Couplings	Same as External 2 trigger source.
Readback	External 2
Initial S/W Revision	Prior to A.02.00
Modified at S/W Revision	A.03.00
Help Map ID	3407

Trigger Level

Sets the value where the signal at the external 2 trigger input will synchronize with the periodic timer trigger. This same level is used in the Ext2 trigger source in the Trigger menu. See [“Trigger Level” on page 1720](#) for information on this key and the SCPI command.

Trig Slope

Controls the trigger polarity. It is set positive to trigger on a rising edge and negative to trigger on a falling edge. This same value is used in the Ext2 trigger source in the Trigger menu. See [“Trig Slope” on page 1720](#) for information on this key and the SCPI command

RF Burst

Pressing the key once selects the RF burst envelope signal to be used for the periodic timer trigger synchronization. Press the key a second time to access the RF burst sync source setup menu.

Key Path	Trigger, Periodic Timer, Sync Source
Example	TRIG:FRAM:SYNC RFB
Couplings	Same as RF Burst trigger source.
Readback	RF Burst
Initial S/W Revision	Prior to A.02.00
Help Map ID	3410

Trigger Level

Sets the trigger level to be used for the RF Burst trigger. This same level is used in the RF Burst trigger source in the Trigger menu. See [“Absolute Trigger Level” on page 1722](#) for information on this key and the SCPI command.

Trig Slope

Controls the RF Burst trigger polarity. It is set positive to trigger on a rising edge and negative to trigger on a falling edge. This same value is used in the RF Burst trigger source in the Trigger menu. See [“Trigger Slope” on page 1725](#) for information on this key and the SCPI command

Trig Delay

This setting delays the measurement timing relative to the Periodic Timer.

Key Path	Trigger, Periodic Timer
Remote Command	:TRIGger[:SEquence]:FRAMe:DELAy <time> :TRIGger[:SEquence]:FRAMe:DELAy? :TRIGger[:SEquence]:FRAMe:DELAy:STATe OFF ON 0 1 :TRIGger[:SEquence]:FRAMe:DELAy:STATe?
Notes	Note that delay is used when the sync source is not set to OFF. If the sync source is set to OFF, offset is used.
Preset	Off, 1.000 us
State Saved	Saved in instrument state
Min	-150 ms
Max	+500 ms
Default Unit	s
Initial S/W Revision	Prior to A.02.00
Help Map ID	3401

Common Measurement Functions 1

Sync Holdoff

Sync Holdoff specifies the duration that the sync source signal must be kept false before the transition to true to be recognized as the sync timing. The periodic timer phase is aligned when the sync source signal becomes true, after the Holdoff time is satisfied.

A holdoff of 2 ms works with most WiMAX signals, but there may be cases where the burst off duration is less than 1 ms and this value will need to be changed.

Key Path	Trigger, Periodic Timer
Remote Command	:TRIGger [:SEQuence] :FRAMe:SYNC:HOLDoff <time> :TRIGger [:SEQuence] :FRAMe:SYNC:HOLDoff? :TRIGger [:SEQuence] :FRAMe:SYNC:HOLDoff:STATe OFF ON 0 1 :TRIGger [:SEQuence] :FRAMe:SYNC:HOLDoff:STATe?
Preset	On, 1.000 ms
State Saved	Saved in instrument state
Min	0 ms
Max	+500 ms
Default Unit	s
Initial S/W Revision	Prior to A.02.00
Help Map ID	3518

Baseband I/Q

Pressing this key when it is not selected selects Baseband I/Q as the trigger. Pressing the key when it is already selected accesses the Baseband I/Q trigger type selection menu. The key is annotated to display which of the Baseband I/Q trigger types is currently selected.

Key Path	Trigger
State Saved	Saved in instrument state
Readback	The Baseband I/Q trigger source that becomes active when this key is selected is displayed. The possible values are "I/Q Mag", "I", "Q", "Input I", "Input Q", and "Aux I/Q Mag".
Initial S/W Revision	Prior to A.02.00
Help Map ID	29986

I/Q Mag

Pressing this key, when it is not selected, selects the I/Q magnitude signal as the trigger. The I/Q Magnitude trigger condition is met when the I/Q magnitude crosses the I/Q magnitude trigger level. The

magnitude is measured at the output of the main I/Q digital receiver.

Key Path	Trigger, Baseband I/Q
Example	TRIG:<meas>:SOUR IQM
Readback Text	I/Q Mag
Initial S/W Revision	Prior to A.02.00
Help Map ID	29952

Trigger Level

Sets a level for the I/Q magnitude trigger. When the signal crosses this level, with the chosen slope, the trigger occurs. If the specific measurement displays the signal from the chosen sampling point a green line is displayed to indicate the trigger level.

Key Path	Trigger, Baseband I/Q, I/Q Mag
Remote Command	:TRIGger[:SEquence]:IQMag:LEVel <ampl > :TRIGger[:SEquence]:IQMag:LEVel?
Example	TRIG:IQM:LEV -30 dBm
Notes	The I/Q reference impedance is used for converting between power and voltage.
Preset	-25 dBm
State Saved	Saved in instrument state
Range	-200 dBm to 100 dBm
Readback Text	<level> dBm
Initial S/W Revision	Prior to A.02.00
Help Map ID	29953

Trig Slope

Controls the trigger polarity. It is set positive to trigger on a rising edge and negative to trigger on a falling edge.

Key Path	Trigger, Baseband I/Q, I/Q Mag
Remote Command	:TRIGger[:SEquence]:IQMag:SLOPe POSitive NEGative :TRIGger[:SEquence]:IQMag:SLOPe?
Example	TRIG:IQM:SLOP POS
Preset	POSitive
State Saved	Saved in instrument state
Initial S/W Revision	Prior to A.02.00

Common Measurement Functions 1

Help Map ID	29954
-------------	-------

Trig Delay

Controls a time delay during which the test set waits to begin a sweep after meeting the trigger criteria. You can use negative delay to pre-trigger the instrument in time domain or FFT.

Key Path	Trigger, Baseband I/Q, I/Q Mag
Remote Command	:TRIGger[:SEquence]:IQMag:DELay <time> :TRIGger[:SEquence]:IQMag:DELay? :TRIGger[:SEquence]:IQMag:DELay:STATe OFF ON 0 1 :TRIGger[:SEquence]:IQMag:DELay:STATe?
Example	TRIG:IQM:DEL 10 ms TRIG:IQM:DEL:STAT ON
Preset	1 us OFF
State Saved	Saved in instrument state
Range	-2.5 s to +10 s
Initial S/W Revision	Prior to A.02.00
Help Map ID	29955

I (Demodulated)

Pressing this key, when it is not selected, selects the main receiver's output I voltage as the trigger. The I (Demodulated) trigger condition is met when the I voltage crosses the I voltage trigger level.

Key Path	Trigger, Baseband I/Q
Example	TRIG:<meas>:SOUR IDEM
Readback Text	I
Initial S/W Revision	Prior to A.02.00
Help Map ID	29956

Trigger Level

Sets a level for the I (Demodulated) trigger. When the signal crosses this level, with the chosen slope, the trigger occurs. If the specific Measurement displays the signal from the chosen sampling point a green line is displayed to indicate the trigger level.

Key Path	Trigger, Baseband I/Q, I (Demodulated)
Remote Command	:TRIGger[:SEquence]:IDEMod:LEVel <voltage> :TRIGger[:SEquence]:IDEMod:LEVel?

Example	TRIG:IDEM:LEV 0.5 V
Preset	0.25 V
State Saved	Saved in instrument state
Range	-1 to 1 V
Readback Text	0.1 of displayed unit (V, mV, et cetera)
Initial S/W Revision	Prior to A.02.00
Help Map ID	29957

Trig Slope

Controls the trigger polarity. It is set positive to trigger on a rising edge and negative to trigger on a falling edge.

Key Path	Trigger, Baseband I/Q, I (Demodulated)
Remote Command	:TRIGger[:SEquence]:IDEMod:SLOPe POSitive NEGative :TRIGger[:SEquence]:IDEMod:SLOPe?
Example	TRIG:IDEM:SLOP POS
Preset	POSitive
State Saved	Saved in instrument state
Initial S/W Revision	Prior to A.02.00
Help Map ID	29958

Trig Delay

Controls a time delay during which the test set waits to begin a sweep after meeting the trigger criteria. You can use negative delay to pre-trigger the instrument in time domain or FFT.

Key Path	Trigger, Baseband I/Q, I (Demodulated)
Remote Command	:TRIGger[:SEquence]:IDEMod:DELay <time> :TRIGger[:SEquence]:IDEMod:DELay? :TRIGger[:SEquence]:IDEMod:DELay:STATe OFF ON 0 1 :TRIGger[:SEquence]:IDEMod:DELay:STATe?
Example	TRIG:IDEM:DEL 10 ms TRIG:IDEM:DEL:STAT ON
Preset	1 us OFF
State Saved	Saved in instrument state
Range	-2.5 s to +10 s

Common Measurement Functions 1

Initial S/W Revision	Prior to A.02.00
Help Map ID	29959

Q (Demodulated)

Pressing this key, when it is not selected, selects the main receiver's output Q voltage as the trigger. The Q (Demodulated) trigger condition is met when the Q voltage crosses the Q voltage trigger level.

Key Path	Trigger, Baseband I/Q
Example	TRIG:<meas>:SOUR QDEM
Readback Text	Q
Initial S/W Revision	Prior to A.02.00
Help Map ID	29987

Trigger Level

Sets a level for the Q (Demodulated) trigger. When the signal crosses this level, with the chosen slope, the trigger occurs. If the specific Measurement displays the signal from the chosen sampling point a green line is displayed to indicate the trigger level.

Key Path	Trigger, Baseband I/Q, Q (Demodulated)
Remote Command	:TRIGger[:SEquence]:QDEMod:LEVel <voltage> :TRIGger[:SEquence]:QDEMod:LEVel?
Example	TRIG:QDEM:LEV 0.5 V
Preset	0.25 V
State Saved	Saved in instrument state
Range	-1 to 1 V
Readback Text	0.1 of displayed unit (V, mV, et cetera)
Initial S/W Revision	Prior to A.02.00
Help Map ID	29960

Trig Slope

Controls the trigger polarity. It is set positive to trigger on a rising edge and negative to trigger on a falling edge.

Key Path	Trigger, Baseband I/Q, Q (Demodulated)
Remote Command	:TRIGger[:SEquence]:QDEMod:SLOPe POSitive NEGative :TRIGger[:SEquence]:QDEMod:SLOPe?
Example	TRIG:QDEM:SLOP POS
Preset	POSitive

State Saved	Saved in instrument state
Initial S/W Revision	Prior to A.02.00
Help Map ID	29961

Trig Delay

Controls a time delay during which the test set waits to begin a sweep after meeting the trigger criteria. You can use negative delay to pre-trigger the instrument in time domain or FFT.

Key Path	Trigger, Baseband I/Q, Q (Demodulated)
Remote Command	:TRIGger[:SEquence]:QDEMod:DELay <time> :TRIGger[:SEquence]:QDEMod:DELay? :TRIGger[:SEquence]:QDEMod:DELay:STATe OFF ON 0 1 :TRIGger[:SEquence]:QDEMod:DELay:STATe?
Example	TRIG:QDEM:DEL 10 ms TRIG:QDEM:DEL:STAT ON
Preset	1 us OFF
State Saved	Saved in instrument state
Range	-2.5 s to +10 s
Initial S/W Revision	Prior to A.02.00
Help Map ID	29962

Input I

Pressing this key, when it is not selected, selects the I channel's ADC voltage as the trigger. The Input I trigger condition is met when the voltage crosses the trigger level.

Key Path	Trigger, Baseband I/Q
Example	TRIG:<meas>:SOUR IINP
Readback Text	Input I
Initial S/W Revision	Prior to A.02.00
Help Map ID	29963

Trigger Level

Sets a level for the Input I trigger. When the signal crosses this level, with the chosen slope, the trigger occurs.

Key Path	Trigger, Baseband I/Q, Input I
----------	---------------------------------------

Common Measurement Functions 1

Remote Command	:TRIGger[:SEquence]:IINPut:LEVel <voltage> :TRIGger[:SEquence]:IINPut:LEVel?
Example	TRIG:IINP:LEV 0.5 V
Preset	0.25 V
State Saved	Saved in instrument state
Range	-1 to 1 V
Readback Text	0.1 of displayed unit (V, mV, et cetera)
Initial S/W Revision	Prior to A.02.00
Help Map ID	29964

Trig Slope

Controls the trigger polarity. It is set positive to trigger on a rising edge and negative to trigger on a falling edge.

Key Path	Trigger, Baseband I/Q, Input I
Remote Command	:TRIGger[:SEquence]:IINPut:SLOPe POSitive NEGative :TRIGger[:SEquence]:IINPut:SLOPe?
Example	TRIG:IINP:SLOP POS
Preset	POSitive
State Saved	Saved in instrument state
Initial S/W Revision	Prior to A.02.00
Help Map ID	29965

Trig Delay

Controls a time delay during which the test set waits to begin a sweep after meeting the trigger criteria. You can use negative delay to pre-trigger the instrument in time domain or FFT.

Key Path	Trigger, Baseband I/Q, Input I
Remote Command	:TRIGger[:SEquence]:IINPut:DELay <time> :TRIGger[:SEquence]:IINPut:DELay? :TRIGger[:SEquence]:IINPut:DELay:STATe OFF ON 0 1 :TRIGger[:SEquence]:IINPut:DELay:STATe?
Example	TRIG:IINP:DEL 10 ms TRIG:IINP:DEL:STAT ON
Preset	1 us OFF

State Saved	Saved in instrument state
Range	-2.5 s to +10 s
Initial S/W Revision	Prior to A.02.00
Help Map ID	29966

Input Q

Pressing this key, when it is not selected, selects the Q channel's ADC voltage as the trigger. The Input Q trigger condition is met when the voltage crosses the trigger level.

Key Path	Trigger, Baseband I/Q
Example	TRIG:<meas>:SOUR QINP
Readback Text	Input Q
Initial S/W Revision	Prior to A.02.00
Help Map ID	29967

Trigger Level

Sets a level for the Input Q trigger. When the signal crosses this level, with the chosen slope, the trigger occurs.

Key Path	Trigger, Baseband I/Q, Input Q
Remote Command	:TRIGger [:SEquence] :QINPut :LEVe1 <voltage> :TRIGger [:SEquence] :QINPut :LEVe1?
Example	TRIG:QINP:LEV 0.5 V
Preset	0.25 V
State Saved	Saved in instrument state
Range	-1 to 1 V
Readback Text	0.1 of displayed unit (V, mV, etc.)
Initial S/W Revision	Prior to A.02.00
Help Map ID	29968

Trig Slope

Controls the trigger polarity. It is set positive to trigger on a rising edge and negative to trigger on a falling edge.

Key Path	Trigger, Baseband I/Q, Input Q
Remote Command	:TRIGger [:SEquence] :QINPut :SLOPe POSitive NEGative :TRIGger [:SEquence] :QINPut :SLOPe?
Example	TRIG:QINP:SLOP POS

Common Measurement Functions 1

Preset	POSitive
State Saved	Saved in instrument state
Initial S/W Revision	Prior to A.02.00
Help Map ID	29969

Trig Delay

Controls a time delay during which the test set waits to begin a sweep after meeting the trigger criteria. You can use negative delay to pre-trigger the instrument in time domain or FFT.

Key Path	Trigger, Baseband I/Q, Input Q
Remote Command	:TRIGger [:SEquence] :QINPut :DELay <time> :TRIGger [:SEquence] :QINPut :DELay? :TRIGger [:SEquence] :QINPut :DELay:STATe OFF ON 0 1 :TRIGger [:SEquence] :QINPut :DELay:STATe?
Example	TRIG:QINP:DEL 10 ms TRIG:QINP:DEL:STAT ON
Preset	1 us OFF
State Saved	Saved in instrument state
Range	-2.5 s to +10 s
Initial S/W Revision	Prior to A.02.00
Help Map ID	29970

Auxiliary Channel I/Q Mag

Pressing this key, when it is not selected, selects the Auxiliary Channel I/Q magnitude signal as the trigger. The Auxiliary Channel I/Q Magnitude trigger condition is met when the auxiliary receiver's I/Q magnitude output crosses the Auxiliary I/Q magnitude trigger level.

Key Path	Trigger, Baseband I/Q
Example	TRIG:<meas>:SOUR AIQM
Readback Text	Aux I/Q Mag
Initial S/W Revision	Prior to A.02.00
Help Map ID	29971

Trigger Level

Sets a level for the I/Q magnitude trigger. When the signal crosses this level, with the chosen slope, the trigger

occurs.

Key Path	Trigger, Baseband I/Q, Aux Channel I/Q Mag
Remote Command	:TRIGger[:SEquence]:AIQMag:LEVel <ampl > :TRIGger[:SEquence]:AIQMag:LEVel?
Example	TRIG:AIQM:LEV -30 dBm
Notes	The I/Q reference impedance is used for converting between power and voltage.
Preset	-25 dBm
State Saved	Saved in instrument state
Range	-200 dBm to 100 dBm
Readback Text	<level> dBm
Initial S/W Revision	Prior to A.02.00
Help Map ID	29972

Trig Slope

Controls the trigger polarity. It is set positive to trigger on a rising edge and negative to trigger on a falling edge.

Key Path	Trigger, Baseband I/Q, Aux Channel I/Q Mag
Remote Command	:TRIGger[:SEquence]:AIQMag:SLOPe POSitive NEGative :TRIGger[:SEquence]:AIQMag:SLOPe?
Example	TRIG:AIQM:SLOP POS
Preset	POSitive
State Saved	Saved in instrument state
Initial S/W Revision	Prior to A.02.00
Help Map ID	29973

Trig Delay

Controls a time delay during which the test set waits to begin a sweep after meeting the trigger criteria. You can use negative delay to pre-trigger the instrument in time domain or FFT.

Key Path	Trigger, Baseband I/Q, Aux Channel I/Q Mag
Remote Command	:TRIGger[:SEquence]:AIQMag:DELAy <time> :TRIGger[:SEquence]:AIQMag:DELAy? :TRIGger[:SEquence]:AIQMag:DELAy:STATe OFF ON 0 1 :TRIGger[:SEquence]:AIQMag:DELAy:STATe?

Common Measurement Functions 1

Example	TRIG:AIQM:DEL 10 ms TRIG:AIQM:DEL:STAT ON
Preset	1 us OFF
State Saved	Saved in instrument state
Range	-2.5 s to +10 s
Initial S/W Revision	Prior to A.02.00
Help Map ID	29974

Trigger Center Frequency

This key sets the center frequency to be used by the auxiliary receiver.

Key Path	Trigger, Baseband I/Q, Aux Channel I/Q Mag
Remote Command	:TRIGger[:SEQuence]:AIQMag:CENTer <freq> :TRIGger[:SEQuence]:AIQMag:CENTer?
Example	:TRIG:AIQM:CENT 10 MHz
Notes	Trigger CF + 1/2 Trigger BW < Max Trigger CF - 1/2 Trigger BW > Min
Preset	0 Hz
State Saved	Saved in instrument state
Range	-40 MHz to 40 MHz
Initial S/W Revision	Prior to A.02.00
Help Map ID	29975

Trigger Bandwidth

This key sets the information bandwidth used by the auxiliary receiver for the Auxiliary Channel I/Q Magnitude trigger.

Key Path	Trigger, Baseband I/Q, Aux Channel I/Q Mag
Remote Command	:TRIGger[:SEQuence]:AIQMag:BANDwidth <freq> :TRIGger[:SEQuence]:AIQMag:BANDwidth?
Example	:TRIG:AIQM:BAND 8 MHz

Notes	<p>The combined sample rate for the main and auxiliary receivers cannot exceed 100 MSa/sec. The bandwidth available to the Trigger BW is limited to what is available after the main receiver's bandwidth (Info BW, sometimes pre-FFT BW) is set. Because of this limitation, the Max is not always achievable.</p> <p>The combination of Trigger Center Freq and Trigger BW is also limited: $\text{Trigger CF} + 1/2 \text{ Trigger BW} < \text{Max}$ $\text{Trigger CF} - 1/2 \text{ Trigger BW} > \text{Min}$</p>
Preset	<p>Bandwidth option dependent:</p> <p>No Opt: 10 MHz Opt B25: 25 MHz Opt S40: 40 MHz</p>
State Saved	Saved in instrument state
Range	10 Hz to Maximum
Initial S/W Revision	Prior to A.02.00
Help Map ID	29976

Auto/Holdoff

Opens up a menu that lets you adjust Auto Trigger and Trigger Holdoff parameters

Key Path	Trigger
Readback line	<p>Displays a summary of the Auto Trig and Holdoff settings, in square brackets</p> <p>First line: Auto Off or Auto On</p> <p>Second Line: "Hldf" followed by:</p> <ul style="list-style-type: none"> • If Holdoff is Off, readback Off • If Holdoff On and Type = Normal, readback value • If Holdoff On and Type = Above, readback value followed by AL • If Holdoff On and Type = Below, readback value followed by BL • If Holdoff Type selection is not supported by the current measurement, Holdoff Type is always Normal
Initial S/W Revision	A.02.00
Help Map ID	29989

Auto Trig

Sets the time that the test set waits for the trigger conditions to be met. If they are not met after that much time, then the test set is triggered anyway.

Key Path	Trigger, Auto/Holdoff
----------	-----------------------

Common Measurement Functions 1

Remote Command	:TRIGger[:SEQuence]:ATRigger <time> :TRIGger[:SEQuence]:ATRigger? :TRIGger[:SEQuence]:ATRigger:STATe OFF ON 0 1 :TRIGger[:SEQuence]:ATRigger:STATe?
Example	TRIG:ATR:STAT ON TRIG:ATR 100 ms
Notes	The "time that the test set waits" starts when the test set is ready for a trigger, which may be hundreds of ms after the data acquisition for a sweep is done. The "time" ends when the trigger condition is satisfied, not when the delay ends.
Preset	Off, 100 ms
State Saved	Saved in instrument state
Min	1 ms
Max	100 s
Default Unit	s
Initial S/W Revision	Prior to A.02.00
Help Map ID	3436

Trig Holdoff

Sets the holdoff time between triggers. When the trigger condition is satisfied, the trigger occurs, the delay begins, and the holdoff time begins. New trigger conditions are ignored until the holdoff time expires. For a free-running trigger, the holdoff value is the minimum time between triggers.

Key Path	Trigger, Auto/Holdoff
Remote Command	:TRIGger[:SEQuence]:HOLDoff <time> :TRIGger[:SEQuence]:HOLDoff? :TRIGger[:SEQuence]:HOLDoff:STATe OFF ON 0 1 :TRIGger[:SEQuence]:HOLDoff:STATe?
Example	TRIG:HOLD:STAT ON TRIG:HOLD 100 ms
Preset	Off, 100 ms
State Saved	Saved in instrument state
Min	0 s
Max	0.5 s
Default Unit	s
Initial S/W Revision	Prior to A.02.00

Help Map ID

3437

Holdoff Type

Lets you set the Trigger Holdoff Type.

NOTE

Holdoff Type is not supported by all measurements. If the current measurement does not support it, this key is blank and the Holdoff Type is Normal. If the Holdoff Type SCPI is sent while in such a measurement, the SCPI is accepted and the setting remembered, but it will have no effect until a measurement is in force that supports Holdoff Type.

Trigger Holdoff Type functionality:**NORMal**

This is the “oscilloscope” type of trigger holdoff, and is the setting when the Holdoff Type key does not appear. In this type of holdoff, no new trigger is accepted until the holdoff interval has expired after the previous trigger.

ABOVE

If the trigger slope is positive, a trigger event is generated only if the signal characteristic of interest crosses the trigger threshold (with positive slope) and then remains above the threshold for at least the holdoff time. For negative slope, the trigger event is generated if the signal characteristic crosses the threshold (with negative slope) after having been above the threshold for at least the holdoff time. In either case, the trigger event is associated with the time the level was crossed.

BELow

If the trigger slope is positive, a trigger event is generated only if the signal characteristic of interest crosses the trigger threshold (with positive slope) after having been below the threshold for at least the holdoff time. For negative slope, the trigger event is generated if the signal characteristic crosses the threshold (with negative slope) and then remains below the threshold for at least the holdoff time. In either case, the trigger event is associated with the time the level was crossed.

Key Path	Trigger, Auto/Holdoff
Remote Command	:TRIGger[:SEquence]:HOLDoff:TYPE NORMal ABOVE BELow :TRIGger[:SEquence]:HOLDoff:TYPE?
Example	TRIG:HOLD:TYPE NORM
Preset	All modes but GSM/EDGE: Normal GSM/EDGE: Below
State Saved	Saved in instrument state
Initial S/W Revision	A.02.00
Help Map ID	29990

Common Measurement Functions 1

View/Display

This section describes the Display key, which is the key in the View/Display menu that is common to multiple Modes and Measurements. See the Measurement descriptions for information on the View functions of each measurement.

Display

The **Display** menu is common to most measurements, and is used for configuring items on the display. Some **Display** menu settings apply to all the measurements in a mode, and some only to the current measurement. Those under the **System Display Settings** key apply to all measurements in all modes.

Key Path:	Display
Key Path:	View/Display
Initial S/W Revision:	Prior to A.02.00
Help Map ID:	3440

Annotation

Turns on and off various parts of the display annotation. The annotation is divided up into four categories:

1. **Meas Bar:** This is the measurement bar at the top of the screen. It does not include the settings panel or the Active Function. Turning off the Meas Bar turns off the settings panel and the Active Function. When the Meas Bar is off, the graticule area expands to fill the area formerly occupied by the Meas Bar.
2. **Screen Annotation:** this is the annotation and annunciation around the graticule, including any annotation on lines (such as the display line, the threshold line, etc.) This does NOT include the marker number or the N dB result. When off, the graticule expands to fill the entire graticule area.
3. **Trace annotation:** these are the labels on the traces, showing their detector (or their math mode).
4. **Active Function annotation:** this is the active function display in the meas bar, and all of the active function values displayed on softkeys.

See the figure below. Each type of annotation can be turned on and off individually.

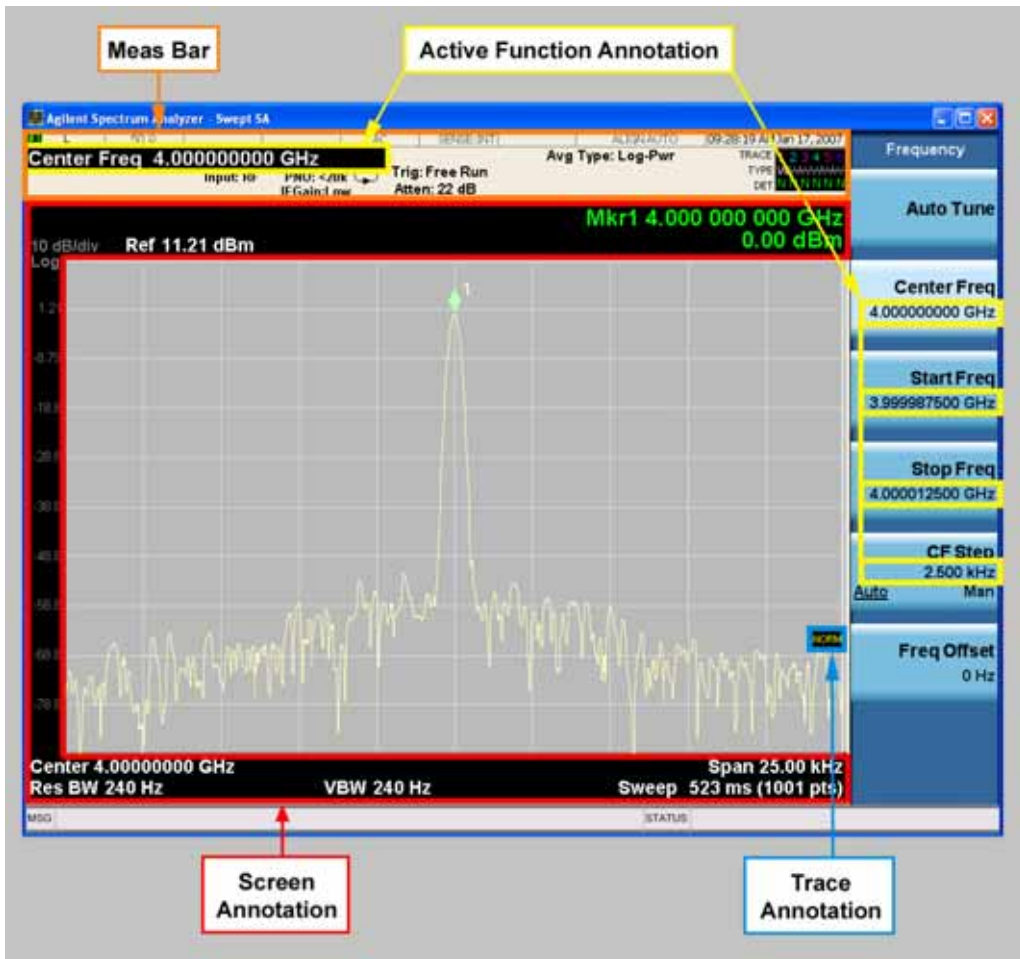

Key Path:	View/Display, Display
Initial S/W Revision:	Prior to A.02.00
Help Map ID:	3441

Meas Bar On/Off

This function turns the Measurement Bar on and off, including the settings panel. When off, the graticule area expands to fill the area formerly occupied by the Measurement Bar.

Key Path:	View/Display, Display, Annotation
Remote Command:	:DISPlay:ANNOtation:MBAR[:STATe] OFF ON 0 1 :DISPlay:ANNOtation:MBAR[:STATe]?
Example:	DISP:ANN:MBAR OFF
Dependencies:	Grayed out and forced to OFF when System Display Settings, Annotation is set to Off.

Common Measurement Functions 1

Preset:	On This should remain Off through a Preset when System Display Settings, Annotation is set to Off.
State Saved:	Saved in instrument state.
Initial S/W Revision:	Prior to A.02.00
Help Map ID:	3443

Screen

This controls the display of the annunciation and annotation around the graticule, including any annotation on lines (such as the display line, the threshold line, etc.) and the y-axis annotation. This does NOT include marker annotation (or the N dB result). When off, the graticule expands to fill the entire graticule area, leaving only the 1.5% gap above the graticule as described in the Trace/Detector chapter.

Key Path:	View/Display, Display, Annotation
Remote Command:	:DISPlay:ANNotation:SCReen[:STATe] OFF ON 0 1 :DISPlay:ANNotation:SCReen[:STATe] ?
Example:	DISP:ANN:SCR OFF
Dependencies:	Grayed-out and forced to OFF when System Display Settings, Annotation is set to Off.
Preset:	On This should remain Off through a Preset when System Display Settings, Annotation is set to Off
State Saved:	Saved in instrument state.
Initial S/W Revision:	Prior to A.02.00
Help Map ID:	3442

Trace

Turns on and off the labels on the traces, showing their detector (or their math mode) as described in the Trace/Detector section.

If trace math is being performed with a trace, then the trace math annotation will replace the detector annotation.

Key Path:	View/Display, Display, Annotation
Remote Command:	:DISPlay:ANNotation:TRACe[:STATe] ON OFF 1 0 :DISPlay:ANNotation:TRACe[:STATe] ?
Example:	DISP:ANN:TRAC OFF
Preset:	Off
State Saved:	Saved in instrument state.

Initial S/W Revision:	Prior to A.02.00
Help Map ID:	3444

Active Function Values On/Off

Turns on and off the active function display in the Meas Bar, and all of the active function values displayed on the softkeys.

Note that all of the softkeys that have active functions have these numeric values blanked when this function is on. This is a security feature..

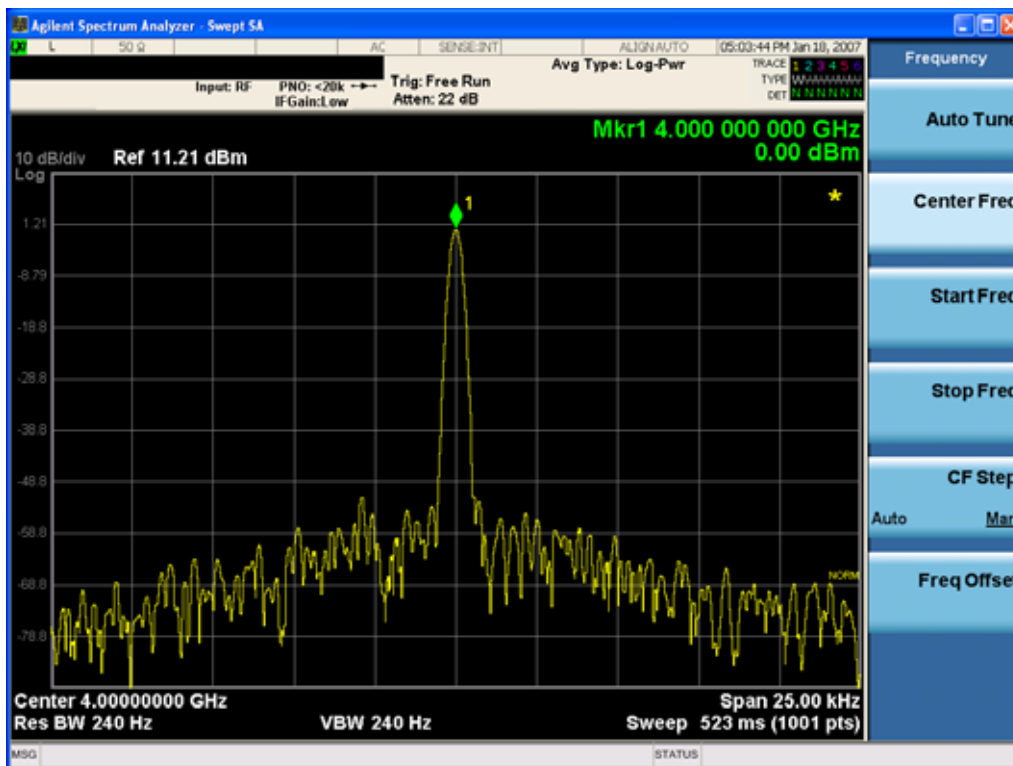

Key Path:	View/Display, Display, Annotation
Remote Command:	:DISPlay:ACTivefunc [:STATE] ON OFF 1 0 :DISPlay:ACTivefunc [:STATE] ?
Example:	DISP:ACT OFF
Dependencies:	Grayed out and forced to OFF when System Display Settings, Annotation is set to Off.
Preset:	On This should remain Off through a Preset when System Display Settings, Annotation is set to Off
State Saved:	Saved in instrument state.
Initial S/W Revision:	Prior to A.02.00

Common Measurement Functions 1

Help Map ID:	3445
--------------	------

Title

Displays menu keys that enable you to change or clear a title on your display.

Key Path:	View/Display, Display
Initial S/W Revision:	Prior to A.02.00
Help Map ID:	3446

Change Title

Writes a title into the "measurement name" field in the banner, for example, "Channel Power".

Press **Change Title** to enter a new title through the alpha editor. Press **Enter** or **Return** to complete the entry. Press **Cancel (Esc)** to cancel the entry and preserve your existing title.

The display title will replace the measurement name. It remains for this measurement until you press **Change Title** again, or you recall a state, or a Preset is performed. A title can also be cleared by pressing **Title, Clear Title**.

NOTE Notice the inclusion of the <measurement> parameter in the command below. Because each measurement remembers the Display Title, the command must be qualified with the measurement name.

Key Path:	View/Display, Display, Title
Mode:	All
Remote Command:	:DISPlay:<measurement>:ANNotation:TITLe:DATA <string> :DISPlay:<measurement>:ANNotation:TITLe:DATA?
Example:	DISP:ACP:ANN:TITL:DATA "This Is My Title" This example sets the title to: This Is My Title
Notes:	Pressing this key cancels any active function. When a title is edited the previous title remains intact (it is not cleared) and the cursor goes at the end so that characters can be added or BKSP can be used to go back over previous characters.
Preset:	No title (measurement name instead)
State Saved:	Saved in instrument state.
Initial S/W Revision:	Prior to A.02.00
Modified at S/W Revision:	A.02.00, A.03.00
Help Map ID:	3447

Clear Title

Clears a title from the front-panel display. Once cleared, the title cannot be retrieved. After the title is cleared, the

current Measurement Name replaces it in the title bar.

Key Path:	View/Display, Display, Title
Example:	The following commands clear the title and restore the measurement's original title: DISP:ACP:ANN:TITL:DATA "" This example is for ACP; the measurement name is required.
Notes:	Uses the :DISPlay:<measurement>:ANNotation:TITLe:DATA <string> command with an empty string.
Preset:	Performed on Preset.
Initial S/W Revision:	Prior to A.02.00
Help Map ID:	3448

Graticule

Pressing Graticule turns the display graticule On or Off. It also turns the graticule y-axis annotation on and off.

Key Path:	View/Display, Display
Remote Command:	:DISPlay:WINDow[1]:TRACe:GRATicule:GRID[:STATe] OFF ON 0 1 :DISPlay:WINDow[1]:TRACe:GRATicule:GRID[:STATe]?
Example:	DISP:WIND:TRAC:GRAT:GRID OFF
Notes:	The graticule is the set of horizontal and vertical lines that make up the grid/divisions for the x-axis and y-axis.
Preset:	On
State Saved:	saved in instrument state
Initial S/W Revision:	Prior to A.02.00
Help Map ID:	3449

Display Line

Activates an adjustable horizontal line that is used as a visual reference line. The line's vertical position corresponds to its amplitude value. The value of the display line (for example, "-20.3 dBm") appears above the line itself on the right side of the display in the appropriate font.

The display line can be adjusted using the step keys, knob, or numeric keypad. The unit of the Display Line is determined by the **Y axis unit** setting under **Amplitude**. If more than one window has a display line, the display line of the selected window is controlled.

If the display line is off the screen, it shows as a line at the top/bottom of the screen with an arrow pointing up or down. As with all such lines (Pk Thresh, Trigger Level, etc.) it is drawn on top of all traces.

Common Measurement Functions 1

The display line is unaffected by Auto Couple.

Key Path:	View/Display, Display
Remote Command:	:DISPlay:WINDow[1]:TRACe:Y:DLINe <amp;l> :DISPlay:WINDow[1]:TRACe:Y:DLINe? :DISPlay:WINDow[1]:TRACe:Y:DLINe:STATe OFF ON 0 1 :DISPlay:WINDow[1]:TRACe:Y:DLINe:STATe?
Example:	DISP:WIND:TRAC:Y:DLIN:STAT ON DISP:WIND:TRAC:Y:DLIN:STAT -32 dBm
Preset:	Set the Display Line to Off and -25 dBm on Preset. When the Display Line goes from Off to On, if it is off screen, set it to either the top or bottom of screen, depending on which direction off screen it was. The Display Line's value does not change when it is turned off.
State Saved:	Saved in instrument state.
Min:	-∞ (minus infinity) in current units
Max:	+∞ (plus infinity) in current units
Default Unit:	Depends on the current selected Y axis unit
Initial S/W Revision:	Prior to A.02.00
Help Map ID:	3450

System Display Settings

These settings are "Mode Global" – they affect all modes and measurements and are reset only by **Restore Misc Defaults** or **Restore System Defaults** under System.

Key Path:	View/Display, Display
Initial S/W Revision:	Prior to A.02.00
Help Map ID:	3488

Annotation Local Settings

This is a Mode Global override of the meas local annotation settings. When it is **All Off**, it forces **Screen Annotation, Meas Bar, Trace, and Active Function Values** settings to be **OFF** for all measurements in all modes. This provides the security based "annotation off" function of previous test sets; hence it uses the legacy SCPI command.

When it is **All Off**, the **Screen, Meas Bar, Trace, and Active Function Values** keys under the **Display, Annotation** menu are grayed out and forced to **Off**. When **Local Settings** is selected, you are able to set the local annotation settings on a measurement by measurement basis.

Key Path:	View/Display, Display, System Display Settings
-----------	---

Remote Command:	:DISPlay:WINDow[1]:ANNotation[:ALL] OFF ON 0 1 :DISPlay:WINDow[1]:ANNotation[:ALL]?
Example:	:DISP:WIND:ANN OFF
Preset:	On (Set by Restore Misc Defaults)
State Saved:	Not saved in instrument state.
Backwards Compatibility Notes:	The WINDow parameter and optional subopcode is included for backwards compatibility but ignored – all windows are equally affected.
Initial S/W Revision:	Prior to A.02.00
Help Map ID:	3451

Theme

This key allows you to change the Display theme. This is similar to the Themes selection under Page Setup and Save Screen Image. The four themes are detailed below.

Key Path:	View/Display, Display, System Display Settings
Remote Command:	:DISPlay:THEME TDColor TDMonochrome FCOLor FMONochrome :DISPlay:THEME?
Example:	DISP:THEM TDM sets the display theme to 3D Monochrome.
Notes:	TDColor – 3D is the standard color theme with filling and shading TDMonochrome – is similar to 3D color, but only black is used FCOLor – flat color is intended for inkjet printers to conserve ink. It uses a white background instead of black. FMONochrome – is like flat color, but only black is used
Preset:	TDColor (Set by Restore Misc Defaults)
State Saved:	Not saved in instrument state.
Initial S/W Revision:	Prior to A.02.00
Help Map ID:	3452

Backlight

Accesses the display backlight on/off keys. This setting may interact with settings under the Windows "Power" menu.

When the backlight is off, pressing ESC, TAB, SPACE, ENTER, UP, DOWN, LEFT, RIGHT, DEL, BKSP, CTRL, or ALT turns the backlight on without affecting the application. Pressing any other key will turn backlight on and could potentially perform the action as well.

Key Path:	View/Display, Display, System Display Settings
-----------	---

Common Measurement Functions 1

Remote Command:	:DISPlay:BACKlight ON OFF :DISPlay:BACKlight?
Preset:	ON (Set by Restore Misc Defaults)
Initial S/W Revision:	Prior to A.02.00
Help Map ID:	3453

On

Turns the display backlight on.

Key Path:	View/Display, Display, System Display Settings, Backlight
Example:	DISP:BACK ON
Readback:	On
Initial S/W Revision:	Prior to A.02.00
Help Map ID:	3516

Off

Turns the display backlight off.

Key Path:	View/Display, Display, System Display Settings, Backlight
Example:	DISP:BACK OFF
Readback:	Off
Initial S/W Revision:	Prior to A.02.00
Help Map ID:	3517

Backlight Intensity

An active function used to set the backlight intensity. It goes from 0 to 100 where 100 is full on and 0 is off. This value is independent of the values set under the Backlight on/off key.

Key Path:	View/Display, Display, System Display Settings
Remote Command:	:DISPlay:BACKlight:INTensity <integer> :DISPlay:BACKlight:INTensity?
Example:	DISP:BACK:INT 50
Preset:	100 (Set by Restore Misc Defaults)
Min:	0
Max:	100
Initial S/W Revision:	Prior to A.02.00

Help Map ID:

3454

Full Screen

When **Full Screen** is pressed the measurement window expands horizontally over the entire instrument display. The screen graticule area expands to fill the available display area.

It turns off the display of the softkey labels, however the menus and active functions still work. (Though it would obviously be very hard to navigate without the key labels displayed.) Pressing **Full Screen** again while Full Screen is in effect cancels Full Screen.

Note that the banner and status lines are unaffected. You can get even more screen area for your data display by turning off the Meas Bar (in the Display menu) which also turns off the settings panel.

Full Screen is a Meas Global function. Therefore it is cancelled by the **Preset** key.

Key Path:	Display
Remote Command:	:DISPlay:FSCReen[:STATe] OFF ON 0 1 :DISPlay:FSCReen[:STATe] ?
Preset:	Off
State Saved:	Not saved in instrument state.
Backwards Compatibility SCPI:	:DISPlay:MENU[:STATe] OFF ON 0 1 This emulates ESA full screen functionality, which is the same as the FSCReen command in PSA except that the sense of on/off is reversed (that is, OFF means the menus are OFF, so Fullscreen is ON) and the default is ON (meaning Fullscreen is OFF).
Backwards Compatibility Notes:	1. In ESA/PSA, Full Screen was turned on with a softkey, so pressing any other key turned Full Screen off. In the X-Series, because a hardkey is provided to turn this function on and off, pressing any other key no longer turns off Full Screen
Initial S/W Revision:	Prior to A.02.00
Help Map ID:	3464

Display Enable (Remote Command Only)

Turns the display on/off, including the display drive circuitry. The backlight stays lit so you can tell that the instrument is on. The display enable setting is mode global. The reasons for turning the display off are three:

- To increase speed as much as possible by freeing the instrument from having to update the display
- To reduce emissions from the display, drive circuitry
- For security purposes

If you have turned off the display:

- and you are in local operation, the display can be turned back on by pressing any key or by sending

Common Measurement Functions 1

the SYSTem:DEFaults MISC command or the DISPlay:ENABle ON (neither *RST nor SYSTem:PRESet enable the display.)

- and you are in remote operation, the display can be turned back on by pressing the **Local** or **Esc** keys or by sending the SYSTem:DEFaults MISC command or the DISPlay:ENABle ON (neither *RST nor SYSTem:PRESet enable the display.)

and you are using either the SYSTem:KLOCK command or GPIB local lockout, then no front-panel key press will turn the display back on. You must turn it back on remotely.

Remote Command:	:DISPlay:ENABle OFF ON 0 1 :DISPlay:ENABle?
Example:	DISP:ENAB OFF
Couplings:	DISP:ENAB OFF turns Backlight OFF and DISP:ENAB ON turns Backlight ON. However, settings of Backlight do not change the state of DISP:ENAB
Preset:	On Set by SYST:DEF MISC, but Not affected by *RST or SYSTem:PRESet.
State Saved:	Not saved in instrument state.
Backwards Compatibility Notes:	1. SYST:PRES no longer turns on DISPlay:ENABle as it did in legacy analyzers
Initial S/W Revision:	Prior to A.02.00
Help Map ID:	0

Common Measurement Functions 2

The key and command descriptions in this section describe functions that operate identically in multiple measurements and/or modes. This section is a library of functions that is referenced by many measurements and modes

To find the exact description and parameters for functions in a specific measurement, always look in the measurement section of this documentation. Pressing the front-panel key or softkey and then pressing the green Help key also provides the correct information.

NOTE If you want to print the documentation, be sure to select this section and the measurement of interest to ensure having all the information you need. See [“Printing Acrobat Files” on page 134](#) for further instructions about printing.

AMPTD Y Scale (Amplitude)

Accesses a menu that enables you to control input signal conditioning as well as the Y-scaling of trace data. Input signal conditioning actually affects the input signal and the associated measurement quality, whereas Y-scaling is non-destructive of data. Even if the data is scaled so as to be clipped or completely off the display, the marker readouts are still correct and accurate data can still be retrieved via SCPI.

Key Path:	Front Panel
Initial S/W Revision:	Prior to A.02.00
Help Map ID:	25884

Range

Represents the amplitude of the largest sinusoidal signal that could be present within the IF without being clipped by the ADC. For signals with high peak-to-rms ratios, the range may need to exceed the rms signal power by a fair amount to avoid clipping.

Key Path:	AMPTD Y Scale
Mode:	VSA, LTE, LTETDD, IDEN
Remote Command:	[:SENSE] :POWER [:RF] :RANGE <real> [:SENSe] :POWER [:RF] :RANGe?
Example:	POW:RANG 25 POW:RANG?
Notes:	The parameter is interpreted as dBm
Preset:	20
State Saved:	Saved in instrument state.

Common Measurement Functions 2

Min:	depends on model and preamp options
Max:	depends on model and preamp options
Initial S/W Revision:	Prior to A.02.00
Modified at S/W Revision:	A.02.00
Help Map ID:	25757

Y Axis Scaling

Enables you to view the entire range of the data or zoom in on a range of interest. Scaling does not affect measurement setup, and rescaling can be done at any time on paused or complete measurements and the results of the rescaling are immediately visible. Y scaling can be made to track range setting for convenience in setting up measurements.

Key Path:	AMPTD Y Scale
Mode:	VSA, LTE, LTETDD, IDEN
Initial S/W Revision:	Prior to A.02.00
Modified at S/W Revision:	A.02.00
Help Map ID:	25885

Select Trace

This function is a duplicate of the same function found on the Trace/Detector menu. The Select Trace key is also located here to enable you to conveniently choose which trace the Y scaling applies.

See [“Select Trace” on page 1831](#) for details.

Key Path:	AMPTD Y Scale, Y Axis Scaling
Mode:	VSA, LTE, LTETDD, IDEN
Initial S/W Revision:	Prior to A.02.00
Modified at S/W Revision:	A.02.00
Help Map ID:	Use 25779

Y Auto Scale

Changes the Y reference value and Scale per Division so the full trace is displayed without clipping.

Key Path:	AMPTD Y Scale
Mode:	VSA, LTE, LTETDD, IDEN
Measurement:	<meas>:=VECTor ADEMod DDEMod W11A W11B EVM IPOWer IDEMod MOTotalk
Remote Command:	:DISPlay:<meas>:TRACe [1] 2 3 4 : Y [: SCALE] : AUTO : ONCE

Example:	:DISP:VECT:TRAC1:Y:AUTO:ONCE
Initial S/W Revision:	Prior to A.02.00
Modified at S/W Revision:	A.02.00
Help Map ID:	25762

Y Reference Value

Controls the Y value of the selected trace at the Reference Position. It has no effect on hardware input settings.

See “Y Reference: Position” on page 1763 for more details.

Key Path:	AMPTD Y Scale
Mode:	VSA, LTE, LTETDD, IDEN
Measurement:	<meas>:=VECTor ADEMod DDEMod W11A W11B EVM IPOWER IDEMod MOTotalk
Remote Command:	:DISPlay:<meas>:TRACe [1] 2 3 4 :Y [:SCALE] :RLEVel <real> :DISPlay:<meas>:TRACe [1] 2 3 4 :Y [:SCALE] :RLEVel?
Example:	DISP:VECT:TRAC:Y:RLEV 20 DISP:VECT:TRAC:Y:RLEV?
Couplings:	None. This does not affect any hardware input settings.
Preset:	Depends on trace
State Saved:	Saved in instrument state.
Min:	-9.9E+37
Max:	9.9E+37
Initial S/W Revision:	Prior to A.02.00
Modified at S/W Revision:	A.02.00
Help Map ID:	25758

Y Scale Per Division

Controls the Y scale per division of the selected trace.

Key Path:	AMPTD Y Scale
Mode:	VSA, LTE, LTETDD, IDEN
Measurement:	<meas>:=VECTor ADEMod DDEMod W11A W11B EVM IPOWER IDEMod MOTotalk

Common Measurement Functions 2

Remote Command:	:DISPlay:<meas>:TRACe [1] 2 3 4:Y[:SCALe]:PDIVision <real> :DISPlay:<meas>:TRACe [1] 2 3 4:Y[:SCALe]:PDIVision?
Example:	DISP:VECT:TRAC:Y:PDIV 10 DISP:VECT:TRAC:Y:PDIV?
Couplings:	None.
Preset:	Depends on trace
State Saved:	Saved in instrument state.
Min:	-9.9E+37
Max:	9.9E+37
Initial S/W Revision:	Prior to A.02.00
Modified at S/W Revision:	A.02.00
Help Map ID:	25759

Couple Ref to Range

When Couple Ref to Range is on, Y scaling is adjusted when the Range changes. For example, on traces with Y units of dBm, the reference value changes by the same amount in dB as the Range does. On a trace with Y units of Volts, the Per Division setting changes by a factor of approximately 1.25 when the Range changes by 2 dB. This function can be turned on or off for each individual trace.

Key Path:	AMPTD Y Scale
Mode:	VSA, LTE, LTETDD, IDEN
Measurement:	<meas>:=VECTor ADEMod DDEMod W11A W11B EVM IPOWer IDEMod MOTotalk
Remote Command:	:DISPlay:<meas>:TRACe [1] 2 3 4:Y[:SCALe]:RLEVel:AUTO OFF ON 0 1 :DISPlay:<meas>:TRACe [1] 2 3 4:Y[:SCALe]:RLEVel:AUTO?
Example:	DISP:VECT:TRAC1:Y:RLEV:AUTO ON DISP:VECT:TRAC1:Y:RLEV:AUTO?
Notes:	Range coupling is not available for Phase and Group delay traces.
Preset:	1
State Saved:	Saved in instrument state.
Range:	On Off
Initial S/W Revision:	Prior to A.02.00
Modified at S/W Revision:	A.02.00

Help Map ID:	25760
--------------	-------

Y Reference: Position

Sets the position of the reference line for Y scaling for the selected trace. It can be set to the top, bottom, or center of the grid.

Key Path:	AMPTD Y Scale
Mode:	VSA, LTE, LTETDD, IDEN
Measurement:	<meas>:=VECTor ADEMod DDEMod W11A W11B EVM IPOWER IDEMod MOTotalk
Remote Command:	:DISPlay:<meas>:TRACe [1] 2 3 4 :Y [:SCALE] :RPOSition TOP CENTER BOTTom :DISPlay:<meas>:TRACe [1] 2 3 4 :Y [:SCALE] :RPOSition?
Example:	DISP:VECT:TRAC1:Y:RPOS TOP DISP:VECT:TRAC1:Y:RPOS?
Couplings:	Changing trace format or data can affect this. Each format "remembers" its reference position.
Preset:	Depends on trace format and trace data. Top for LogMag or most LinearMag traces, middle for Real, Imaginary, Vector displays, Eye diagrams, Phase, Delay, Bottom for Linear Mag EVM.
State Saved:	Saved in instrument state.
Range:	Top Ctr Bottom
Initial S/W Revision:	Prior to A.02.00
Modified at S/W Revision:	A.02.00
Help Map ID:	25761

Y Unit Preference

Displays a menu that enables you to set the preferred Y unit for the selected trace. You can select Peak, RMS, Power units, or an automatic selection. The automatic selection uses Power units for frequency domain data and Peak units for time domain data.

Key Path:	AMPTD Y Scale
Mode:	VSA, LTE, LTETDD, IDEN
Measurement:	<meas>:=VECTor ADEMod DDEMod W11A W11B EVM IPOWER IDEMod MOTotalk
Remote Command:	:DISPlay:<meas>:TRACe [1] 2 3 4 :Y:UNIT:PREFErence AUTO PEAK RMS POWER MRMS :DISPlay:<meas>:TRACe [1] 2 3 4 :Y:UNIT:PREFErence?

Common Measurement Functions 2

Example:	DISP:VECT:TRAC1:Y:UNIT:PREF PEAK DISP:VECT:TRAC1:Y:UNIT:PREF?
Preset:	AUTO
State Saved:	Saved in instrument state.
Range:	AUTO PEAK RMS POW MRMS
Readback Text:	Auto Peak RMS Power mRMS
Initial S/W Revision:	Prior to A.02.00
Modified at S/W Revision:	A.02.00
Help Map ID:	25763

The following SCPI only command can be used to determine exactly which Y unit was chosen based on the setting of the above:

Key Path:	AMPTD Y Scale
Mode:	VSA, LTE, LTETDD, IDEN
Measurement:	<meas>:=VECTor ADEMod DDEMod W11A W11B EVM IPOWER IDEMod MOTotalk
Remote Command:	:DISPlay:<meas>:TRACe [1] 2 3 4 : Y : UNIT?
Example:	DISP:VECT:TRAC1:Y:UNIT?
Initial S/W Revision:	Prior to A.02.00
Modified at S/W Revision:	A.02.00
Help Map ID:	0

Y Log Ratio

Enabled if the Trace Format is set to LogMag (Linear Unit). In this format type, you set the Y Log Ratio instead of Y Scale Per Division to determine Y scaling. It sets the ratio of the top of the Y axis to the bottom.

Key Path:	AMPTD Y Scale
Mode:	VSA, LTE, LTETDD, IDEN
Measurement:	<meas>:=VECTor ADEMod DDEMod W11A W11B EVM IPOWER IDEMod MOTotalk
Remote Command:	:DISPlay:<meas>:TRACe [1] 2 3 4 : Y : LRATio <real> :DISPlay:<meas>:TRACe [1] 2 3 4 : Y : LRATio?
Example:	DISP:VECT:TRAC1:Y:LRAT 10000 DISP:VECT:TRAC1:Y:LRAT?

Notes:	This is grayed out if the trace format is not Log Mag (linear unit).
Preset:	100000
State Saved:	Saved in instrument state.
Min:	1.001
Max:	100e6
Initial S/W Revision:	Prior to A.02.00
Modified at S/W Revision:	A.02.00
Help Map ID:	25765

Vector Horiz Center

Sets the position of the origin for Vector trace formats such as I-Q and Constellation. When using one of these formats, you set the vertical (imaginary) axis scaling with the Y Reference Value, Y Reference Position, and Y Scale Per Division properties. The scaling of the horizontal axis is set to maintain an aspect ratio of 1:1.

Key Path:	AMPTD Y Scale
Mode:	VSA, LTE, LTETDD, IDEN
Measurement:	<meas>:=VECTor ADEMod DDEMod W11A W11B EVM IPOWER IDEMod MOTotalk
Remote Command:	:DISPlay:<meas>:TRACe [1] 2 3 4 :VHCenter <real> :DISPlay:<meas>:TRACe [1] 2 3 4 :VHCenter?
Example:	DISP:DDEM:TRAC1:VHC 0.2 DISP:DDEM:TRAC1:VHC?
Preset:	0
State Saved:	Saved in instrument state.
Min:	-9.9e37
Max:	9.9e37
Initial S/W Revision:	Prior to A.02.00
Modified at S/W Revision:	A.02.00
Help Map ID:	25766

Copy Y Scale

Copies the following Y scaling information from the selected trace to another:

- Y reference Position
- Y Reference Value

Common Measurement Functions 2

- Y Unit Preference
- Vector Horiz Center
- Couple Ref to Range
- Y Log Ratio
- Y Reference Line

This is a front-panel only function.

Key Path:	AMPTD Y Scale, Y Axis Scaling
Mode:	VSA, LTE, LTETDD, IDEN
Initial S/W Revision:	Prior to A.02.00
Modified at S/W Revision:	A.02.00
Help Map ID:	25886

Reference Line

Controls whether the Y reference line is visible or not.

Key Path:	AMPTD Y Scale
Mode:	VSA, LTE, LTETDD, IDEN
Measurement:	<meas>:=VECTor ADEMod DDEMod W11A W11B EVM IPOWer IDEMod MOTotalk
Remote Command:	:DISPlay:<meas>:TRACe [1] 2 3 4:RLINe OFF ON 0 1 :DISPlay:<meas>:TRACe [1] 2 3 4:RLINe?
Example:	DISP:VECT:TRAC1:RLIN ON DISP:VECT:TRAC1:RLIN?
Preset:	OFF
State Saved:	Saved in instrument state.
Initial S/W Revision:	Prior to A.02.00
Modified at S/W Revision:	A.02.00
Help Map ID:	25767

BW (Bandwidth)

Displays a menu that enables you to control the resolution bandwidth of the spectrum measurement result, as well as the shape of the resolution bandwidth filter (controlled by the FFT windowing function).

Key Path:	Front Panel
-----------	--------------------

Mode:	VSA, LTE, LTETDD, IDEN
Initial S/W Revision:	Prior to A.02.00
Modified at S/W Revision:	A.02.00
Help Map ID:	25888

Res BW

Enables you to select the resolution bandwidth of the measurement. Res BW is mathematically related to Time length and Window type, so changing one of these, directly or indirectly, must change at least one other.

Res BW and Time length are related by the following equation:

$$\text{Res BW} = \text{ENBW} / T$$

where:

ENBW is the normalized effective noise bandwidth of the Window. See [“FFT Window” on page 1769](#) for more details).

T is the time record length.

Therefore, **if you change Res BW, Main Time must also change**, and vice versa. (If the Gate function is on, then it is Gate Length, not Main Time, that is related to Res BW by the above equation.)

For convenience, Res BW is by default also coupled to Span (but not vice versa). This coupling can be turned off. See [“Res BW Coupling” on page 1768](#) for more details.

Limits:

- The minimum Res Bw to Span ratio is related to the maximum Main Time length, and is given by:
 $\text{ENBW} / 409600$ if Freq points state parameter is set to Auto
 $\text{ENBW} / (\text{Freq Points} - 1)$ if Freq points parameter is manually set
- The maximum Res BW to Span ratio is related to the minimum time record size (16 points for most windows, 17 points for Flat Top), and is given by:
 $\text{ENBW} / 12.5$
 $(\text{ENBW} / 13.28125 \text{ for Flat Top window})$

See [“Main Time” on page 1826](#) for more on relationships between Res BW and time.

Key Path:	BW
Mode:	VSA
Measurement:	<meas>:=VECTor ADEMod IPOWER IDEMod MOTotalk
Remote Command:	[:SENSE] :<meas>:BANDwidth BWIDth[:RESolution] <bandwidth> [:SENSE] :<meas>:BANDwidth BWIDth[:RESolution]?

Common Measurement Functions 2

Example:	VECT:BWID 200 KHZ VECT:BWID?
Notes:	Key blanked in any other measurement than Vector or Analog Demod
Couplings:	Changing Main Time or Gate Length changes Res BW. See Res BW Coupling for other changes that can affect (or be affected by) Res BW
Preset:	300 kHz
State Saved:	Saved in instrument state.
Min:	-9.9e37
Max:	9.9e37
Initial S/W Revision:	Prior to A.02.00
Modified at S/W Revision:	A.02.00
Help Map ID:	25790

Res BW Coupling

Enables you to control how Res BW is affected by other parameters. The three possible settings are:

Span: (default) This setting keeps the ratio of Res BW:Span constant whenever the Span is changed. However, you can change the Res BW at will, and doing so establishes a new Res BW:Span ratio.

Min: This setting is only available when the Freq Points property is manually set, and is disabled (forceful grey out) when Freq Points is Auto. It maintains the RBW at the minimum possible value given the settings for Freq Points, Span, and Window. Res BW coupling is changed from Min to Span if you manually set Res BW.

Fixed: This setting attempts to keep the Res BW setting fixed as Span, Freq Points, or FFT Window type change. Changing FFT Window causes Main Time (or Gate) length to change in order to keep the Res BW Fixed. Res BW coupling is forced to Fixed mode any time you turn the Gate function on or manually set Main Time length. See [“Main Time” on page 1826](#) for details.

If a requested change to Res BW or Time Length (Main or Gate) causes the Res BW to go outside the minimum or maximum Res BW: Span limits (see [“Res BW” on page 1767](#) for specifics), the Res BW is clipped at the appropriate limit. The Time length is then set according to the limited Res BW.

In Fixed coupling mode, if increasing the Span causes the new Res BW:Span to drop below the minimum, or if decreasing Span would cause the new Res BW:Span to exceed the maximum, the requested Span is accepted and then the Res BW is changed to the limiting value. The associated Time length is updated.

In Fixed or Span coupling, increasing Freq Points does not cause the Main (or Gate) Time Length to increase. It only adds zero padding to the array that is used in the FFT to calculate the Spectrum. Therefore, it does not affect Res BW. If decreasing Freq Points decreases the maximum time length below the current Main Time, then the Main Time length is clipped to the new limits. If Gating is on, the Gate Delay is first limited, then the Gate Length. The Res BW is then updated as a result of the Time changes.

In Fixed or Span coupling, changing the Window Type does not affect RBW unless it falls outside the limits calculated using the new window. Then the Res BW is clipped at the appropriate limit. The associated Time length is also updated.

Key Path:	BW
Mode:	VSA
Measurement:	<meas>:=VECTor ADEMod IPOWER IDEMod MOTotalk
Remote Command:	[:SENSE] : <meas> : BANDwidth BWIDth [:RESolution] : COUPle SPAN MIN FIXed [:SENSE] : <meas> : BANDwidth BWIDth [:RESolution] : COUPle?
Example:	VECT:BWID:COUP FIX VECT:BWID:COUP?
Notes:	Blanked when in any other measurement than Vector or Analog Demod MIN is not available if Freq Points is set to Auto and trying to set it generates error -221 Settings conflict
Couplings:	See narrative above table and also “Res BW” on page 1767
Preset:	SPAN
State Saved:	Saved in instrument state.
Range:	Span Min Fixed
Initial S/W Revision:	Prior to A.02.00
Modified at S/W Revision:	A.02.00
Help Map ID:	25791

FFT Window

Displays a menu that enables you to choose the Window function that is applied to the time data prior to the FFT calculation used for Spectrum and PSD displays. Four windows are available.

Window name	Common usage	Normalized ENBW (Hz-s)
Uniform	Transient or self-windowing signals, signals that are periodic within a time record length.	1.0
Hanning	Frequency resolution	1.5
Gaussian	High dynamic range	2.21536
Flat Top	High amplitude accuracy	3.8194

The normalized ENBW is the equivalent noise bandwidth, that is, the width of a rectangular filter that

Common Measurement Functions 2

passes the same amount of white noise as the window. It is used to define the resolution bandwidth.

Key Path:	BW
Mode:	VSA, LTE, LTETDD, IDEN
Measurement:	<meas>:=VECTor ADEMod DDEMod W11A W11B EVM IPOWer IDEMod MOTotalk
Remote Command:	[:SENSe] :<meas>:FFT:WINDow [:TYPE] UNIForm HANning GAUSSian FLATtop [:SENSe] :<meas>:FFT:WINDow [:TYPE] ?
Example:	VECT:FFT:WIND GAUS VECT:FFT:WIND?
Couplings:	See Res BW and Res BW Coupling
Preset:	FLAT
State Saved:	Saved in instrument state.
Range:	Uniform Hanning Gaussian (High Dyn Rng) Flat Top (High Amptd Accy)
Readback Text:	Uniform Hanning Gaussian Flat Top
Initial S/W Revision:	Prior to A.02.00
Modified at S/W Revision:	A.02.00
Help Map ID:	25792

FREQ Channel

Displays a menu that enables you to set center frequency, start frequency, stop frequency, and center frequency step. Pressing the Freq hardkey changes the active function to Center Frequency.

The frequency parameters for any vector measurement consist of two pairs of properties: Center Frequency and Span or Start Frequency and Stop Frequency. These behave much as they do in any other application, but there is the additional constraint that the span is limited to much less than the center frequency range.

If you change center frequency, the start and stop frequencies change by the same amount.

If you change span, start frequency and stop frequency are changed by 1/2 the span change.

If you change start frequency, stop frequency remains fixed and span and center frequency are refigured accordingly. Changing stop frequency has similar behavior.

Limits:

If you change the start frequency such that it equals or exceeds the stop frequency, the new start frequency is accepted if possible and the stop frequency is set to min span above the start. Similarly if you attempt to set the stop below the start, the start frequency moves to a min span below the new stop frequency.

If you reduce the start frequency beyond a max span below the stop, the stop frequency is "dragged

along" such that it is a max span above the new start frequency, and similarly increasing the stop frequency drags the start frequency along if you attempt to increase the span beyond the maximum.

Stop frequency can be 1/2 span above the maximum center frequency, but frequency-domain traces are blanked above the maximum center frequency.

Start frequency can be 1/2 span below the minimum center frequency, but frequency-domain traces are blanked below the minimum center frequency.

Key Path:	Front Panel
Mode:	VSA, LTE, LTETDD, IDEN
Initial S/W Revision:	Prior to A.02.00
Modified at S/W Revision:	A.02.00
Help Map ID:	25889

Center Freq

Sets the frequency of the display Center.

Key Path:	FREQ Channel
Mode:	VSA, LTE, LTETDD, IDEN
Remote Command:	[:SENSE] :FREQuency:CENTer <freq> [:SENSE] :FREQuency:CENTer?
Example:	FREQ:CENT 985 MHZ FREQ:CENT?
Couplings:	Start Freq, Stop Freq, and Span. See “ FREQ Channel ” on page 1770 for more details.
Preset:	1 GHz
State Saved:	Saved in instrument state.
Min:	0 Hz
Max:	Depends on frequency range option.
Initial S/W Revision:	Prior to A.02.00
Modified at S/W Revision:	A.02.00
Help Map ID:	25793

Start Freq

Sets the frequency of the display Start.

Key Path:	FREQ Channel
-----------	---------------------

Common Measurement Functions 2

Mode:	VSA, IDEN
Remote Command:	[:SENSE] :FREQuency:START <freq> [:SENSE] :FREQuency:START?
Example:	FREQ:STAR 980 MHz FREQ:STAR?
Couplings:	Stop Freq, Center Freq, and Span. See “FREQ Channel” on page 1770 for more details.
Preset:	Depends on span option. It is 1/2 max span below 1 GHz.
State Saved:	Saved in instrument state.
Min:	-9.9e37
Max:	9.9e37
Initial S/W Revision:	Prior to A.02.00
Modified at S/W Revision:	A.02.00
Help Map ID:	25794

Stop Freq

Sets the frequency of the display Stop.

Key Path:	FREQ Channel
Mode:	VSA, IDEN
Remote Command:	[:SENSE] :FREQuency:STOP <freq> [:SENSE] :FREQuency:STOP?
Example:	FREQ:STOP 990 MHz FREQ:STOP?
Couplings:	Start Freq, Center Freq, and Span. See “FREQ Channel” on page 1770 for more details.
Preset:	Depends on span option. It is 1/2 max span above 1 GHz.
State Saved:	Saved in instrument state.
Min:	-9.9e37
Max:	9.9e37
Initial S/W Revision:	Prior to A.02.00
Modified at S/W Revision:	A.02.00
Help Map ID:	25795

CF Step

Sets the amount the center frequency changes if it is the active function when you press the Up or Down arrow key. Note: the start and stop frequency also changes by the amount of the CF Step if the Up/Down arrow keys are used to change them; but the key is mainly used in connection with stepping the center frequency, so the legacy key name has been retained. The step size in Auto mode is 1/10th the span. It can be set to any value in manual mode.

Key Path:	FREQ Channel
Mode:	VSA, LTE, LTETDD, IDEN
Remote Command:	[:SENSe] :FREQuency:CENTer:STEP[:INCRement] <freq> [:SENSe] :FREQuency:CENTer:STEP[:INCRement] ? [:SENSe] :FREQuency:CENTer:STEP:AUTO OFF ON 0 1 [:SENSe] :FREQuency:CENTer:STEP:AUTO?
Example:	FREQ:CENT:STEP 1 MHZ FREQ:CENT:STEP? FREQ:CENT:STEP:AUTO ON FREQ:CENT:STEP:AUTO?
Couplings:	1/10th Span when auto is turned on.
Preset:	Depends on span option; 1/10th default span.
State Saved:	Saved in instrument state.
Min:	-9.9e37
Max:	9.9e37
Initial S/W Revision:	Prior to A.02.00
Modified at S/W Revision:	A.02.00
Help Map ID:	25796

Marker

Displays the Marker menu. A marker can be placed on a trace to precisely determine the value of the trace data at the marker position. Markers can also be used in pairs to read the difference (or delta) between two data points. They can also be used to make power calculations over a band of frequencies or a time interval. See [“Marker Function” on page 1792](#) for more details.

The functions in this menu include a 1-of-N selection of the control mode **Normal**, **Delta**, **Fixed**, or **Off** for the selected marker. The control mode is described below.

Pressing **Marker** always makes the selected maker's X position the active function.

If the currently selected marker is **Off**, pressing **Marker** sets it to **Normal** mode and places it at the center of the screen on the currently selected trace.

As a convenience, if there are no markers displayed on the current trace, pressing the marker hardkey

Common Measurement Functions 2

(whenever the marker menu is already showing) selects the lowest numbered marker that is currently off and turns it on in normal mode on the selected trace. In other words, pressing the Marker hardkey twice always turns on a marker on the selected trace if none was turned on before.

Key Path:	Front Panel
Mode:	VSA, LTE, LTETDD, IDEN
Initial S/W Revision:	Prior to A.02.00
Modified at S/W Revision:	A.02.00
Help Map ID:	25859

Select Marker

Specifies the selected marker. The selected marker is the one that is affected by the marker position and properties settings, peak search, and other marker functions. Several menus have a Select Marker key for convenience. Marker selection using any one of these is reflected in all others, in other words, there is only one selected marker for the whole measurement. If all markers are off, then marker 1 becomes the selected marker.

As a convenience, if no markers are displayed on the selected trace, selecting a marker that is off automatically turns it on in normal mode on the selected trace.

There is no SCPI function for selecting a marker. Instead, SCPI functions can explicitly include the index of the marker for which they are to apply. (Most SCPI marker functions that affect the state of a marker also make it the selected marker for front panel commands.)

Key Path:	Marker or Marker> or Marker Function or Peak Search
Mode:	VSA, LTE, LTETDD, IDEN
State Saved:	No
Range:	1 2 3 4 5 6 7 8 9 10 11 12
Initial S/W Revision:	Prior to A.02.00
Modified at S/W Revision:	A.02.00
Help Map ID:	25724

Control Mode

Pressing **Normal**, **Delta**, **Fixed**, or **Off** sets the control mode of the selected marker. The current control mode is shown by highlighting the appropriate key.

The SCPI command in the table below selects the marker and sets the marker control mode as described under [“Normal \(Position\)” on page 1775](#), [“Delta” on page 1775](#), [“Fixed” on page 1776](#) and [“Off” on page 1777](#). All interactions and dependencies detailed under the key description are enforced when the remote command is sent.

Key Path:	Marker
-----------	---------------

Mode:	VSA, LTE, LTETDD, IDEN
Measurement:	<meas>:=VECTor ADEMod DDEMod W11A W11B EVM IPOWer IDEMod MOTotalk
Remote Command:	:CALCulate:<meas>:MARKer[1] 2 3 4 5 6 7 8 9 10 11 12:MO DE POSition DELTA FIXed =OFF :CALCulate:<meas>:MARKer[1] 2 3 4 5 6 7 8 9 10 11 12:MO DE?
Example:	CALC:VECT:MARK1:MODE POS CALC:VECT:MARK1:MODE?
Couplings:	When Delta mode is selected or when the mode is changed from Delta to Off, the marker relative to the selected marker can be affected as described in the text descriptions below.
Preset:	=OFF
State Saved:	Saved in instrument state.
Range:	Normal Delta Fixed Off
Initial S/W Revision:	Prior to A.02.00
Modified at S/W Revision:	A.02.00
Help Map ID:	25725

Normal (Position)

Reports the trace data value (Y value) at a particular point on a trace. The marker's absolute X (and Z) position is specified by you in displayed units. The marker symbol appears on the trace at the specified position and tracks the absolute Y value at that position as it changes from scan to scan. The absolute Y value is displayed in the marker readout area. In older instruments this was called Position mode, and the designation can still be used for backward compatibility.

For Control Mode SCPI command information see: [“Control Mode” on page 1774](#)

Key Path:	Marker
Mode:	VSA, LTE, LTETDD, IDEN
Initial S/W Revision:	Prior to A.02.00
Modified at S/W Revision:	A.02.00
Help Map ID:	0

Delta

Reports the difference between Y values at two points. A delta marker is relative to an associated reference marker on the same trace. (The reference marker can be set on the Marker, Properties, Relative To menu). The reference marker is usually fixed, but can also be normal or delta. The X (and Z) position of a delta marker is specified as an offset from the reference marker position. The delta marker symbol tracks the absolute Y value just like a normal marker, but the marker readout displays the difference

Common Measurement Functions 2

between the absolute Y values of the delta marker and its reference marker (absolute units are used even if the reference is itself a delta marker). Usually this is a straight difference in the current displayed units. For example, if the trace format is LogMag (dBm), the delta marker displays the difference in dB, thus showing a power ratio. But if the trace format is Real, then the delta marker shows a voltage difference, not a ratio. Exceptions for this are:

- When the trace format is **Linear Mag** or **Log Mag (linear unit)** the delta marker displays a voltage ratio or (if the Y Axis unit is Power) a power ratio, rather than a difference.
- When either the marker or its reference has a marker function turned on, the delta marker always displays a ratio or its decibel equivalent. See [“Marker Function” on page 1792](#) for more details on how delta markers work with marker functions. The type of ratio calculated (power or voltage) depends on the delta marker units; the reference marker value is converted as needed so it has compatible units.
- When the trace format is **Wrap Phase**, the delta marker readout is constrained to the wrapped phase display range, which is usually $(-180, +180]$ degrees. For example, if the absolute phase at marker 1 is 170 deg and its reference has phase of -170 deg, the delta does not show 340 deg, but -20 deg. Note that the Wrap Phase display range can be changed (see [“Phase/Trellis Offset” on page 1858](#)).

There is no current support for calculating deltas across traces (and this cannot be done at all unless the traces have the same domain and ranges).

By default, the reference marker for marker 1 is marker 2; for marker 2 is 3 and so on, but the reference marker can be changed. See [“Relative To” on page 1784](#).

For coupling rules, see [“Coupling of Delta and Reference Markers” on page 1777](#).

For Control Mode SCPI command information see: [“Control Mode” on page 1774](#)

Key Path:	Marker
Mode:	VSA, LTE, LTETDD, IDEN
Initial S/W Revision:	Prior to A.02.00
Modified at S/W Revision:	A.02.00
Help Map ID:	0

Fixed

Mainly used as reference markers for Delta markers. A fixed marker's X and Y Axis values can be directly or indirectly specified by you, and they remain fixed once specified, in other words, they do not follow the trace data value. These markers are represented on the display by an “X” rather than a diamond. If a marker is changed from off to fixed, the X and Y (and Z) values are chosen to put it in the center of the display. If the marker is changed from some other type to fixed, the current X and Z values of the marker remain unchanged. The Y value is taken from the current trace data value and must be changed manually thereafter.

For Control Mode SCPI command information see: [“Control Mode” on page 1774](#)

Key Path:	Marker
Mode:	VSA, LTE, LTETDD, IDEN

Initial S/W Revision:	Prior to A.02.00
Modified at S/W Revision:	A.02.00
Help Map ID:	0

Off

Turning a marker off makes it invisible, and also its annotation.

Turning a marker on (i.e., changing its control mode from Off to any other control mode) assigns the marker to the currently selected trace.

For Control Mode SCPI command information see: [“Control Mode” on page 1774](#)

Key Path:	Marker
Mode:	VSA, LTE, LTETDD, IDEN
Initial S/W Revision:	Prior to A.02.00
Modified at S/W Revision:	A.02.00
Help Map ID:	0

Coupling of Delta and Reference Markers

The following coupling rules apply from the front panel and also if the equivalent SCPI commands are sent.

Pressing the Delta key causes the selected marker to become a delta marker if it is not already. Also, the selected marker's reference is affected as follows:

- If the reference marker was off, it is turned on as a fixed marker.
- The reference marker is moved to the trace of the selected marker and set to the same position as the selected marker.
- If the delta marker has a marker function turned on, the reference marker takes on the same function (with the same band limits).

Exception: Pressing Delta when the selected marker's mode is not yet Delta does not move or change a reference marker that is already turned on (Normal, Delta, or Fixed) and on the same trace as the selected marker. It merely changes the selected marker's mode to Delta and shows the current offset between it and the reference. If you press Delta again (when the selected marker is already in Delta mode) then the reference is moved and modified as described above.

When a delta marker is changed to any other control mode, if its reference marker is fixed then the reference marker is also turned off.

If you move a delta marker to a different trace, it is forced to Normal mode and if its reference is fixed, the reference is turned off.

A delta marker is forced to Normal mode if you turn its reference off or if you move its reference to another trace. (In the latter case the reference is not turned off even if it is fixed.)

If you change the selected marker's reference (using the Marker, Properties, Relative To), the selected

Common Measurement Functions 2

marker is forced to Delta mode. This change of the selected marker to Delta mode causes its new reference's control mode and position to change as described above.

Marker Position

Selects which data point in a trace to read out with the marker (or where to locate a fixed marker). The marker position is primarily set in terms of the domain units, not trace points (although it can be set in terms of points via SCPI). The default active function when you press a marker hard key is the X position for the currently selected marker. The exception to this is when the selected marker is fixed. In that case there is no default active function (to prevent inadvertently changing a fixed marker's location).

Marker position is not defined when a marker's control mode is Off. When a marker is turned on in Normal or Delta mode, its X (and Z) values are set to the center of the trace data. If a marker is turned on in Fixed mode, its position is set so that it appears in the middle of the trace grid.

The Marker Position key branches to the Marker Position menu, which enables you to set any position variable relevant to the selected marker's control mode and trace format.

For Normal and Delta markers, usually only Marker X is available. Marker Z is available for trace data with 2-dimensional domain. For Fixed markers, Y can also be set. If the trace format is Vector or Constellation, **Marker Y** controls the real (horizontal axis) value and **Marker Y Imag** controls the imaginary (vertical axis) value. The key (or the keys below it) is grayed out if the selected marker is off.

Key Path:	Marker
Mode:	VSA, LTE, LTETDD, IDEN
Initial S/W Revision:	Prior to A.02.00
Modified at S/W Revision:	A.02.00
Help Map ID:	25726

Marker X

Sets the selected marker's X Axis value position in the current X Axis Scale unit. If the control mode is Off, the SCPI command has no affect other than to cause the marker to become selected. Note that the X value can change if the marker is moved to a trace with a different domain.

The Marker X position is absolute if the marker control mode is Normal or Fixed. If the control mode is Delta, then the X position is relative to the reference marker. The valid X positions are the actual data points in the trace; the marker cannot be located between points. If a SCPI command attempts to place the marker between two points, the X value snaps to the closest point.

Note that for Vector or Constellation format, the X axis is perpendicular to the screen (because the screen axes are used to show the real and imaginary parts of the Y value), so adjusting the X value in this case only causes the marker to move horizontally if the real Y value changes. For Fixed markers on a trace with one of these formats, adjusting the X value does not cause horizontal motion of the marker at all. Instead, use the Marker Y and Marker Y (imag) controls to move the marker horizontally and vertically.

Key Path:	Marker, Marker Position
Mode:	VSA, LTE, LTETDD, IDEN

Measurement:	<meas>:=VECTor ADEMod DDEMod W11A W11B EVM IPOWER IDEMod MOTotalk
Remote Command:	:CALCulate:<meas>:MARKer [1] 2 3 4 5 6 7 8 9 10 11 12 :X <real> :CALCulate:<meas>:MARKer [1] 2 3 4 5 6 7 8 9 10 11 12 :X?
Example:	CALC:VECT:MARK:X 0.325 CALC:VECT:MARK:X?
Notes:	Marker X does not go outside the bounds of the data unless it is Fixed. If you attempt to set it to a value outside the bounds, it is clipped at the closest limit and error -222 Data Out of Range is generated. If suffix is sent, it must match the X units for the trace the marker is on. Otherwise, error -138, "Suffix not allowed" is generated. If you try to read or set the position of a Delta marker, remember that the position is in relative units.
Couplings:	See “Coupling of Delta and Reference Markers” on page 1777. See also: “Couple Markers” on page 1788
Preset:	None until marker is turned on.
State Saved:	Saved in instrument state.
Min:	Depends on trace data
Max:	Depends on trace data
Initial S/W Revision:	Prior to A.02.00
Modified at S/W Revision:	A.02.00
Help Map ID:	25727

SCPI only X position commands

Via SCPI , the marker position can also be set or queried in trace points. In this case, the position setting or reading is absolute regardless of control mode.

NOTE The entered value in Trace Points is immediately translated into the current domain units for setting the value of the marker. The marker’s value in domain units, NOT trace points, is preserved if a change is made to the X Axis scale settings. Thus, if you use this command to place a marker on point 500, which happens at that time to correspond to 13 GHz, and then you change the Start Frequency so that point 500 is no longer 13 GHz, the marker stays at 13 GHz, NOT at point 500.

If the trace the marker is on has a 2-dimensional domain, then the points are numbered in the following way:

Starting at the minimum X and Z position, this point is numbered 0. Each time you increment the point number, increment the X value to the next available value. When X reaches the maximum X position,

Common Measurement Functions 2

then reset X to the minimum and increment the Z value. Then continue incrementing the X position in the same manner as before.

Note that for symbol tables, which have no axes, incrementing the X position in points moves the marker consecutively through all table entries.

Mode:	VSA, LTE, LTETDD, IDEN
Measurement:	<meas>:=VECTor ADEMod DDEMod W11A W11B EVM IPOWer IDEMod MOTotalk
Remote Command:	:CALCulate:<meas>:MARKer [1] 2 3 4 5 6 7 8 9 10 11 12 [:X]:POSition <real> :CALCulate:<meas>:MARKer [1] 2 3 4 5 6 7 8 9 10 11 12 [:X]:POSition?
Example:	CALC:VECT:MARK:POS 25 CALC:VECT:MARK:POS?
Notes:	When a marker control mode is changed from off to any other mode, the X position is set to mid-screen.
Couplings:	See “Coupling of Delta and Reference Markers” on page 1777 . See also: “Couple Markers” on page 1788
Preset:	None until marker is turned on.
State Saved:	Saved in instrument state.
Min:	Depends on trace data
Max:	Depends on trace data
Initial S/W Revision:	Prior to A.02.00
Modified at S/W Revision:	A.02.00
Help Map ID:	0

Marker X Unit can be queried via SCPI

Mode:	VSA, LTE, LTETDD, IDEN
Measurement:	<meas>:=VECTor ADEMod DDEMod W11A W11B EVM IPOWer IDEMod MOTotalk
Remote Command:	:CALCulate:<meas>:MARKer [1] 2 3 4 5 6 7 8 9 10 11 12 :X: UNIT?
Example:	CALC:VECT:MARK:X:UNIT?
Notes:	Query Only
Initial S/W Revision:	Prior to A.02.00
Modified at S/W Revision:	A.02.00

Help Map ID:

0

Marker Y

Enables you to set or read back the selected marker's Y Axis value in the current Y Axis Scale unit. Setting the Y value has no affect (other than to cause the marker to become selected) if the control mode is other than fixed. The query form generates an error if the control mode is Off. Note that the Y value can change if the Y-axis units change, either from a change in format of the trace the marker is on or if the marker is moved to a different trace.

If the selected marker is on a trace that is displayed with Vector or Constellation format, this function controls only the real part of the Y value (i.e., the horizontal axis value). Use the **Marker Y (imag)** control to change the imaginary (vertical) value. Marker Y and Marker Y Imag always set or get the rectangular form of Y, regardless of whether the marker readout is polar or rectangular.

Key Path:	Marker, Marker Position
Mode:	VSA, LTE, LTETDD, IDEN
Measurement:	<meas>:=VECTor ADEMod DDEMod W11A W11B EVM IPOWER IDEMod MOTotalk
Remote Command:	:CALCulate:<meas>:MARKer [1] 2 3 4 5 6 7 8 9 10 11 12 :Y [:REAL] <real> :CALCulate:<meas>:MARKer [1] 2 3 4 5 6 7 8 9 10 11 12 :Y [:REAL] ?
Example:	CALC:VECT:MARK2:Y 0.325 CALC:VECT:MARK2:Y?
Notes:	You cannot set Y unless the marker type is fixed. If the marker becomes fixed after a marker function is turned on, it is set to whatever the Y value was when the marker became fixed. If suffix is sent, it must match the Y units for the trace the marker is on. Otherwise, error -138, "Suffix not allowed" is generated.
Couplings:	Changes if marker is relative to a Delta marker that is turned on or re-zeroed (see "Coupling of Delta and Reference Markers" on page 1777).
Preset:	None until marker is turned on.
State Saved:	Saved in instrument state.
Min:	-9.9E+37
Max:	9.9E+37
Initial S/W Revision:	Prior to A.02.00
Modified at S/W Revision:	A.02.00
Help Map ID:	25728

Common Measurement Functions 2

Marker Y Unit can be queried via SCPI.

Mode:	VSA, LTE, LTETDD, IDEN
Measurement:	<meas>:=VECTor ADEMod DDEMod W11A W11B EVM IPOWer IDEMod MOTotalk
Remote Command:	:CALCulate:<meas>:MARKer [1] 2 3 4 5 6 7 8 9 10 11 12 :Y:UNIT?
Example:	CALC:VECT:MARK:Y:UNIT?
Notes:	Query Only
Initial S/W Revision:	Prior to A.02.00
Modified at S/W Revision:	A.02.00
Help Map ID:	0

Marker Y Imag (Imaginary)

Enables you to set or read back the selected marker's quadrature (imaginary) Y value in the current Y Axis Scale unit. It has no affect (other than to cause the marker to become selected) if the control mode is other than fixed or if the current trace format is not complex (Vector or Constellation). The query form generates an error if it is used for a marker that is not on a complex trace. Marker Y Imag is not affected by whether the marker readout is polar or rectangular.

Key Path:	Marker, Marker Position
Mode:	VSA, LTE, LTETDD, IDEN
Measurement:	<meas>:=VECTor ADEMod DDEMod W11A W11B EVM IPOWer IDEMod MOTotalk
Remote Command:	:CALCulate:<meas>:MARKer [1] 2 3 4 5 6 7 8 9 10 11 12 :Y:IMAGinary <real> :CALCulate:<meas>:MARKer [1] 2 3 4 5 6 7 8 9 10 11 12 :Y:IMAGinary?
Example:	CALC:DDEM:MARK1:Y:IMAG 0.435 CALC:DDEM:MARK1:Y:IMAG?
Notes:	Grayed out unless the marker is fixed and on a vector display. If suffix is sent, it must match the Y units for the trace the marker is on. Otherwise, an Invalid Suffix error is generated. Otherwise, error -138, "Suffix not allowed" is generated. If query is sent while the marker is on a trace whose format is not vector or constellation, NaN (9.91E+37) is returned.
Preset:	None until marker is turned on.
State Saved:	Saved in instrument state.
Min:	Depends on trace format

Max:	Depends on trace format
Initial S/W Revision:	Prior to A.02.00
Modified at S/W Revision:	A.02.00
Help Map ID:	25729

Marker Z

Sets the selected markers Z Axis value in the current Z Axis Scale unit for markers on traces with a 2-dimensional domain. In each case the marker that is addressed becomes the selected marker. It has no affect (other than to cause the marker to become selected) if the control mode is **Off** or if the trace has no Z domain. Note that the Z value can change or become irrelevant if the marker is moved to a trace with a different Z domain or no Z domain.

Note that this Z value is affected if the SCPI command to set marker point position is used.

Key Path:	Marker, Marker Position
Mode:	VSA, LTE, LTETDD, IDEN
Measurement:	<meas>:=VECTor ADEMod DDEMod W11A W11B EVM IPOWER IDEMod MOTotalk
Remote Command:	:CALCulate:<meas>:MARKer [1] 2 3 4 5 6 7 8 9 10 11 12 : Z <real> :CALCulate:<meas>:MARKer [1] 2 3 4 5 6 7 8 9 10 11 12 : Z?
Example:	CALC:OFDM:MARK:Z 12 CALC:OFDM:MARK:Z?
Notes:	Marker Z does not go outside the bounds of the data unless it is Fixed. If you attempt to set it to a value outside the bounds it is clipped at the closest limit, and error -222 Data Out of Range is generated. If suffix is sent, it must match the Z units for the trace the marker is on. Otherwise, error -138, "Suffix not allowed" is generated.
Couplings:	See “Coupling of Delta and Reference Markers” on page 1777 . See also: “Couple Markers” on page 1788
Preset:	None until marker is turned on.
State Saved:	Saved in instrument state.
Min:	Depends on trace data
Max:	Depends on trace data
Initial S/W Revision:	Prior to A.02.00
Modified at S/W Revision:	A.02.00
Help Map ID:	25730

Common Measurement Functions 2

Marker Z Unit can be queried via SCPI.

Mode:	VSA, LTE, LTETDD, IDEN
Measurement:	<meas>:=VECTor ADEMod DDEMod W11A W11B EVM IPOWer IDEMod MOTotalk
Remote Command:	:CALCulate:<meas>:MARKer [1] 2 3 4 5 6 7 8 9 10 11 12 : Z : UNIT?
Example:	CALC:OFDM:MARK:Z:UNIT?
Notes:	Query Only
Initial S/W Revision:	Prior to A.02.00
Modified at S/W Revision:	A.02.00
Help Map ID:	0

Marker Properties

Accesses a menu of common marker properties.

Key Path:	Marker
Mode:	VSA, LTE, LTETDD, IDEN
Initial S/W Revision:	Prior to A.02.00
Help Map ID:	25864

Relative To

Enables you to specify which marker is used as a reference for the selected marker when the selected marker's control mode is set to Delta. By default, the reference marker is numerically one higher than the selected marker, that is, marker 1 is relative to marker 2, marker 2 to marker 3, and so on. Marker 12 by default is relative to marker 1. This key enables you to change the reference marker from the default. Note that a marker cannot be made relative to itself.

Key Path:	Marker, Properties
Mode:	VSA, LTE, LTETDD, IDEN
Measurement:	<meas>:=VECTor ADEMod DDEMod W11A W11B EVM IPOWer IDEMod MOTotalk
Remote Command:	:CALCulate:<meas>:MARKer [1] 2 3 4 5 6 7 8 9 10 11 12 : RE FERENCE <integer> :CALCulate:<meas>:MARKer [1] 2 3 4 5 6 7 8 9 10 11 12 : RE FERENCE?
Example:	CALC:VECT:MARK2:REF 4 CALC:VECT:MARK2:REF?

Notes:	The reference marker cannot be the same value as the selected marker, that is, a marker cannot be relative to itself. The currently selected marker is not an available choice in the relative to selection (i.e., the selected marker appears grayed out). When queried, a single value is returned (the specified marker numbers relative marker).
Couplings:	See “Coupling of Delta and Reference Markers” on page 1777. The old reference remains as it was.
Preset:	2 3 4 5 6 7 8 9 10 11 12 1
State Saved:	Saved in instrument state.
Range:	1 2 3 4 5 6 7 8 9 10 11 12
Initial S/W Revision:	Prior to A.02.00
Modified at S/W Revision:	A.02.00
Help Map ID:	25732

Complex Format

Determines the format for the readout when a marker is placed on a complex display (vector or constellation). The choices are to read out in rectangular or polar coordinates. The readout format applies to the marker display and marker table only; there is no SCPI for reading out the marker value in polar form.

Key Path:	Marker, Properties
Mode:	VSA, LTE, LTETDD, IDEN
Measurement:	<meas>:=VECTor ADEMod DDEMod W11A W11B EVM IPOWER IDEMod MOTotalk
Remote Command:	:CALCulate:<meas>:MARKer [1] 2 3 4 5 6 7 8 9 10 11 12 :CF ORmat RECTangular POLar :CALCulate:<meas>:MARKer [1] 2 3 4 5 6 7 8 9 10 11 12 :CF ORmat?
Example:	CALC:VECT:MARK1:CFOR RECT CALC:VECT:MARK1:CFOR?
Preset:	RECT
State Saved:	Saved in instrument state.
Range:	Rect Polar
Initial S/W Revision:	Prior to A.02.00
Modified at S/W Revision:	A.02.00
Help Map ID:	25733

Common Measurement Functions 2

Marker Trace

Enables you to determine the trace to which a marker is assigned. By default, when a marker is turned on it is assigned to the currently selected trace. You can change that assignment using this control.

Key Path:	Marker, Properties
Mode:	VSA, LTE, LTETDD, IDEN
Measurement:	<meas>:=VECTor ADEMod DDEMod W11A W11B EVM IPOWer IDEMod MOTotalk
Remote Command:	:CALCulate:<meas>:MARKer [1] 2 3 4 5 6 7 8 9 10 11 12 : TR ACe <integer> :CALCulate:<meas>:MARKer [1] 2 3 4 5 6 7 8 9 10 11 12 : TR ACe?
Example:	CALC:VECT:MARK3:TRAC 2 CALC:VECT:MARK3:TRAC?
Couplings:	See “Coupling of Delta and Reference Markers” on page 1777 .
Preset:	Marker is assigned to currently selected trace when turned on.
State Saved:	Saved in instrument state.
Range:	Trace 1 Trace2 Trace 3 Trace 4
Min:	1
Max:	4
Initial S/W Revision:	Prior to A.02.00
Modified at S/W Revision:	A.02.00
Help Map ID:	25734

Marker Count

Enables the frequency counter algorithm on the selected marker. This algorithm can more precisely determine the frequency of a peak. The marker must be on a frequency domain trace, with data coming from hardware. Place the marker on a peak and enable the frequency counter. The marker readout then shows the calculated frequency rather than the marker X position. Only one marker can be counted at any time. Turning on marker count for any marker turns it off for all other markers.

Key Path:	Marker, Properties
Mode:	VSA, IDEN
Measurement:	<meas>:=VECTor ADEMod DDEMod W11A W11B EVM IPOWer IDEMod MOTotalk

Remote Command:	:CALCulate:<meas>:MARKer [1] 2 3 4 5 6 7 8 9 10 11 12 :FC Ount [:STATE] OFF ON 0 1 :CALCulate:<meas>:MARKer [1] 2 3 4 5 6 7 8 9 10 11 12 :FC Ount [:STATE] ?
Example:	CALC:VECT:MARK:FCO ON CALC:VECT:MARK:FCO?
Notes:	Marker must be on a frequency-domain trace and data must be live, not recorded or simulated.
Preset:	OFF
State Saved:	Saved in instrument state.
Range:	Off On
Initial S/W Revision:	Prior to A.02.00
Modified at S/W Revision:	A.02.00
Help Map ID:	25735

The frequency counter result must be read back with the following SCPI command. The Marker X query command only gets the marker's data point position, which is not as accurate as the frequency counter result.

Mode:	VSA, IDEN
Measurement:	<meas>:=VECTor ADEMod DDEMod W11A W11B EVM IPOWER IDEMod MOTotalk
Remote Command:	:CALCulate:<meas>:MARKer [1] 2 3 4 5 6 7 8 9 10 11 12 :FC Ount :X?
Example:	CALC:VECT:MARK:FCO:X?
Notes:	Query only. If the marker counter result is unavailable, NaN is returned.
Initial S/W Revision:	Prior to A.02.00
Modified at S/W Revision:	A.02.00
Help Map ID:	0

Marker Table

Displays the marker data display window below the measurement window. For each marker that is on, information is displayed in the data display window, which includes the marker number, control mode, trace number, X axis scale, X axis value, and the Y-axis result. Additional information is shown for markers that have marker functions turned on.

Key Path:	Marker
Mode:	VSA, LTE, LTETDD, IDEN

Common Measurement Functions 2

Measurement:	<meas>:=VECTor ADEMod DDEMod W11A W11B EVM IPOWer IDEMod MOTotalk
Remote Command:	:CALCulate:<meas>:MARKer:TABLE[:STATe] OFF ON 0 1 :CALCulate:<meas>:MARKer:TABLE[:STATe]?
Example:	CALC:VECT:MARK:TABL ON CALC:VECT:MARK:TABL?
Preset:	OFF
State Saved:	No
Range:	Off On
Initial S/W Revision:	Prior to A.02.00
Modified at S/W Revision:	A.02.00
Help Map ID:	25737

Couple Markers

Affects all currently displayed markers. In general, when coupling is turned on then all Normal or Delta markers with the same (or equivalent) domain as the selected marker move in the same manner as the selected marker. Coupling is relative between markers on the same trace (so that their relative positions in the domain are maintained). Coupling can be absolute between markers on different traces that have equivalent domains. That is, they have the same position in the domain, if possible. (As an example of equivalent domains, demodulated symbol positions can be derived from time by using the current symbol rate). When you move the selected marker, then others on related traces track it. This enables you to correlate different measurement results. For example, you can place a marker at a particular symbol time on an error vector magnitude display, have tracking markers on the symbol table and pre-demod time trace showing you the symbol value, and the actual time-varying signal value at the same point in time.

Absolute coupling is performed only for the lowest numbered Normal or Delta marker on each trace. All other markers on a trace couple relatively. When you turn on marker coupling, the subset of markers that have the same domain as the selected marker track it and all other markers remain at their current location. The absolutely coupled markers within this subset is moved at this time to match the domain setting of the selected marker, with the relatively coupled markers following accordingly to maintain offsets within their respective traces. Those markers with different domains remain at their current location. When you select a marker with a different domain than the previously selected marker, then the subset of markers with that domain go through the same procedure.

Any marker that coupling would move outside its range of X values, remains at the closest limiting value until the selected marker moves in such a way as to bring the coupled X value back into range. If the coupled markers are on data that do not have the same domain resolution, then they are positioned as close to each other as possible.

If markers change mode or trace, or trace data is changed below them, the coupling rules are immediately applied to the new set.

Key Path:	Marker
-----------	---------------

Mode:	VSA, LTE, LTETDD, IDEN
Measurement:	<meas>:=VECTor ADEMod DDEMod W11A W11B EVM IPOWer IDEMod MOTotalk
Remote Command:	:CALCulate:<meas>:MARKer:COUPle[:STATe] OFF ON 0 1 :CALCulate:<meas>:MARKer:COUPle[:STATe]?
Example:	CALC:VECT:MARK:COUP ON CALC:VECT:MARK:COUP?
Preset:	OFF
State Saved:	Saved in instrument state.
Range:	Off On
Initial S/W Revision:	Prior to A.02.00
Modified at S/W Revision:	A.02.00
Help Map ID:	25738

All Markers Off

Turns all markers off and sets the selected marker to 1.

Key Path:	Marker
Mode:	VSA, LTE, LTETDD, IDEN
Measurement:	<meas>:=VECTor ADEMod DDEMod W11A W11B EVM IPOWer IDEMod MOTotalk
Remote Command:	:CALCulate:<meas>:MARKer:AOFF
Example:	CALC:VECT:MARK:AOFF:
Initial S/W Revision:	Prior to A.02.00
Modified at S/W Revision:	A.02.00
Help Map ID:	25739

Marker -> (Marker To)

Provides access to some convenient functions for copying the marker position to a number of frequency and Y-axis scaling parameters. These functions are available from the front panel only. No SCPI is provided, because you can already read the marker position via SCPI and then set any frequency or scaling parameter accordingly, with full accuracy.

Pressing the Marker -> hardkey always makes the selected marker's X position the active function.

If the selected marker is off, pressing the Marker -> hardkey turns on the selected marker in normal

Common Measurement Functions 2

mode on the currently selected trace.

Key Path:	Front Panel
Mode:	VSA, LTE, LTETDD, IDEN
Initial S/W Revision:	Prior to A.02.00
Modified at S/W Revision:	A.02.00
Help Map ID:	25868

Mkr -> CF (Center Frequency)

Sets the center frequency equal to the selected marker's absolute frequency. The marker must be on a frequency-domain trace. The absolute marker frequency is used regardless of whether its control mode is Normal, Delta, or Fixed.

If the currently selected marker is not on when this key is pressed, it is turned on at the center of the screen as a normal type marker.

Key Path:	Marker To
Mode:	VSA, LTE, LTETDD, IDEN
Initial S/W Revision:	Prior to A.02.00
Modified at S/W Revision:	A.02.00
Help Map ID:	25869

Mkr -> CF Step

Sets the center frequency step size equal to the selected marker's frequency. The marker must be on a frequency-domain trace. The absolute marker frequency is used regardless of whether its control mode is Normal, Delta, or Fixed.

If the currently selected marker is not on when this key is pressed, it is turned on at the center of the screen as a normal type marker.

Key Path:	Marker To
Mode:	VSA, LTE, LTETDD, IDEN
Initial S/W Revision:	Prior to A.02.00
Modified at S/W Revision:	A.02.00
Help Map ID:	25870

Mkr -> Start

Sets the start frequency equal to the selected marker's frequency. The marker must be on a frequency-domain trace. The absolute marker frequency is used regardless of whether its control mode is Normal, Delta, or Fixed.

If the currently selected marker is not on when this key is pressed, it is turned on at the center of the screen as a normal type marker.

Key Path:	Marker To
Mode:	VSA, LTE, LTETDD, IDEN
Initial S/W Revision:	Prior to A.02.00
Modified at S/W Revision:	A.02.00
Help Map ID:	25871

Mkr -> Stop

Sets the stop frequency equal to the selected marker's frequency. The marker must be on a frequency-domain trace. The absolute marker frequency is used regardless of whether its control mode is Normal, Delta, or Fixed.

If the currently selected marker is not on when this key is pressed, it is turned on at the center of the screen as a normal type marker.

Key Path:	Marker To
Mode:	VSA, LTE, LTETDD, IDEN
Initial S/W Revision:	Prior to A.02.00
Modified at S/W Revision:	A.02.00
Help Map ID:	25872

Mkr Delta -> Span

Sets the start and stop frequencies equal to the selected marker's frequency and that of its reference. That is, the measurement span is "zoomed in" so that the selected marker and its associated reference appear on the extreme left and right of the display. The marker must be on a frequency-domain trace and its control mode must be Delta.

Key Path:	Marker To
Mode:	VSA, LTE, LTETDD, IDEN
Initial S/W Revision:	Prior to A.02.00
Modified at S/W Revision:	A.02.00
Help Map ID:	25873

Mkr -> Ref Lvl

Sets the Y axis reference value equal to the selected marker's Y value. For example, if the reference position is at the top of the screen, the whole trace is moved up so that the marker appears at the top of

Common Measurement Functions 2

the screen. Note that this is a display scaling function only. The input range remains the same.

Key Path:	Marker To
Mode:	VSA, LTE, LTETDD, IDEN
Initial S/W Revision:	Prior to A.02.00
Modified at S/W Revision:	A.02.00
Help Map ID:	25874

Counter -> CF (Center Frequency)

Sets the frequency of the marker counter to the center frequency. The marker counter function must be on.

Key Path:	Marker To
Mode:	VSA, IDEN
Initial S/W Revision:	Prior to A.02.00
Modified at S/W Revision:	A.02.00
Help Map ID:	25875

Mkr Delta -> CF (Center Frequency)

Sets the center frequency equal to the difference in frequency between the selected Delta marker and its reference. The marker must be on a frequency-domain trace and the selected marker's control mode must be Delta.

Key Path:	Marker To
Mode:	VSA, LTE, LTETDD, IDEN
Initial S/W Revision:	Prior to A.02.00
Modified at S/W Revision:	A.02.00
Help Map ID:	25876

Marker Function

Accesses a menu of selectable marker functions for VSA based measurements.

Marker Functions perform post-processing operations on marker data. Band Functions are Marker Functions that enable you to define a band of frequencies around the marker. The band defines the region of data used for the numerical calculations. These marker functions also enable you to perform mathematical calculations on trace and marker data and report the results of these calculations in place of the normal marker result.

Unlike regular markers, marker function markers are not placed directly on the trace. They are placed at a location that is relative to the result of the function calculation.

The Marker Function menu provides access to power calculations in bands of frequencies or time intervals centered on a marker. It also enables you to make calculations like carrier to noise by combining delta markers with marker functions. Marker functions are generally available for time and frequency domain traces, and not for others. If the marker function calculation is undefined for particular trace data, then "---" is shown in place of a number in the result display and marker table, and `CALC:<meas>:MARK[n]:Y?` returns 9.91E+37 (NaN).

Pressing Marker Function always makes the selected marker's X position the active function.

If the selected marker is off, pressing the Marker Function hardkey turns on the selected marker in normal mode on the currently selected trace.

Key Path:	Front Panel
Mode:	VSA, LTE, LTETDD, IDEN
Measurement:	<meas>:=VECTor ADEMod DDEMod W11A W11B EVM IPOWER IDEMod MOTotalk
Remote Command:	:CALCulate:<meas>:MARKer [1] 2 3 4 5 6 7 8 9 10 11 12 :FU Nction BPower BDensity =OFF :CALCulate:<meas>:MARKer [1] 2 3 4 5 6 7 8 9 10 11 12 :FU Nction?
Example:	CALC:VECT:MARK1:FUNC BPOW CALC:VECT:MARK1:FUNC?
Notes:	:CALC:<meas>:MARK1:FUNC? returns the current function type for marker 1. To return the result, use :CALC:<meas>:MARK1:Y?
Preset:	=OFF
State Saved:	Saved in instrument state.
Range:	Band Power Band Density Off
Initial S/W Revision:	Prior to A.02.00
Modified at S/W Revision:	A.02.00
Help Map ID:	25877

Band/Interval Power

Turns on the Band/Interval Power function for the selected marker. This function calculates the power within the band centered on the marker. The function works generally with frequency spectra, PSD, and time traces. On traces where band power is undefined, the result display shows "---" and `CALC:<meas>:MARK[n]:Y?` returns 9.91E+37 (NaN), although the band interval can still be defined.

Frequency-domain data

If the marker is on a frequency-domain trace, the result is total power within the band. This is true whether the underlying trace data is a power spectrum or power spectral density.

Common Measurement Functions 2

Time-domain data

If the marker is on a time-domain trace, the result is average power within the time interval, that is, the power at each time sample in the time interval is calculated, the powers are summed and the total divided by the number of samples.

Key Path:	Marker Function
Mode:	VSA, LTE, LTETDD, IDEN
Initial S/W Revision:	Prior to A.02.00
Modified at S/W Revision:	A.02.00
Help Map ID:	25878

Band Power Calculation

Shows results in dBm, dBVrms, Watts, Volts RMS Squared or Volts RMS. The table below shows the choice of display units if **Band Power Calculation** is set to **Mean**, depending on the current format and Y units of the trace the marker is on.

Trace data type	Trace Format	Y Unit	Result format
Spectrum, PSD, Time record	LogMag (dB)	Auto, Power	dBm
		Peak, RMS	dBVrms
		mRMS	dBmVrms
	Linear Mag, Real, Imag, Log Mag (lin)	Auto, Peak, RMS, mRMS	Vrms^2
		Power	W
	Wrap Phase, Unwrap Phase, Delay	Any	Vrms^2
Vector, Constellation, Eye, Trellis	Any	blanked	
Dimensionless (e.g., Frequency response, Impulse response, various Demodulation error types)	LogMag (dB)	Any	dBrms
	Linear Mag, Real, Imag, Wrap Phase, Unwrap Phase, Delay, Log Mag (lin)	Any	rms^2
General dimensions(e.g., Hz, %)	LogMag (dB)	Any	dB<unit>rms
	Linear Mag, Real, Imag, Wrap Phase, Unwrap Phase, Delay, Log Mag (lin)	Any	<unit>rms^2

If the **Band Power Calculation** is set to **RMS**, then the readout unit does not depend on trace format or Y unit. For Spectrums, PS, and Time record traces, the displayed unit is "Vrms". For general units, the

unit abbreviation is shown followed by "rms".

The Band Power Calculation only controls the readout format for Normal and Fixed markers. For Delta markers, see “Band Power and Delta Markers” on page 1800.

Key Path:	Marker Function, Band/Interval Power
Mode:	VSA, LTE, LTETDD, IDEN
Measurement:	<meas>:=VECTor ADEMod DDEMod W11A W11B EVM IPOWER IDEMod MOTotalk
Remote Command:	:CALCulate:<meas>:MARKer [1] 2 3 4 5 6 7 8 9 10 11 12 :FU Nction:BPOwer:CTYPe MEAN RMS :CALCulate:<meas>:MARKer [1] 2 3 4 5 6 7 8 9 10 11 12 :FU Nction:BPOwer:CTYPe?
Example:	CALC:VECT:MARK1:FUNC:BPOW:CTYP MEAN CALC:VECT:MARK1:FUNC:BPOW:CTYP?
Preset:	MEAN
State Saved:	Saved in instrument state.
Range:	Mean RMS
Initial S/W Revision:	Prior to A.02.00
Modified at S/W Revision:	A.02.00
Help Map ID:	25748

Band/Interval Density

Calculates the average power density within the band centered on the marker. The function works generally with frequency spectra, PSD, and time traces. On traces where band power cannot reasonably be defined, the result display shows "---" and CALC:<meas>:MARK[n]:Y? returns NaN (9.91E+37), although the band interval can still be defined.

Frequency-domain data

If the marker is on a frequency-domain trace, the result is the band power (as computed above) divided by the bandwidth over which it is measured. This is true whether the underlying trace data is a power spectrum or power spectral density.

Time-domain data

If the marker is on a time-domain trace, the result is average power within the time interval (as computed above) divided by the equivalent noise bandwidth of the span.

Key Path:	Marker Function
Mode:	VSA, LTE, LTETDD, IDEN
Initial S/W Revision:	Prior to A.02.00

Common Measurement Functions 2

Modified at S/W Revision:	A.02.00
Help Map ID:	25879

Band Density Calculation

Turns on the Band/Interval Density function for the selected marker. If the selected marker is off, it is turned on in **Normal** marker mode and is located at the center of the screen.

If **Band/Interval Density** is selected while in the **Marker Function Off** state, the **Band Span** or **Interval Span** is initialized to 5% of the screen width.

If the detector mode for the detector on the marker's trace is set to Auto, the average detector is selected. If the Average type is set to Auto, Power Averaging is selected. Other choices for the detector or Average type usually cause measurement inaccuracy.

A band/interval density calculation result can be shown in dBm/Hz, Volts RMS Squared, or Volts RMS. The following table shows the choice of display units if **Band Density Calculation** is set to **Mean**, depending on the current format of the trace the marker is on.

Trace data type	Trace Format	Result format
Spectrum, PSD, Time record	LogMag (dB)	dBm/Hz
	Linear Mag, Real, Imag, Wrap Phase, Unwrap Phase, Delay, Log Mag (lin)	Vrms^2/Hz
Dimensionless (e.g., Frequency response, Impulse response, various Demodulation error types)	LogMag (dB)	dBrms/Hz
	Linear Mag, Real, Imag, Wrap Phase, Unwrap Phase, Delay, Log Mag (lin)	rms^2/Hz
General dimensions (e.g., Hz, %)	LogMag (dB)	dB<unit>rms/H z
	Linear Mag, Real, Imag, Wrap Phase, Unwrap Phase, Delay, Log Mag (lin)	<unit>rms^2/Hz

If the **Band Density Calculation** is set to **RMS**, then the readout unit does not depend on trace format. For Spectrum, PSD, and Time record traces, the displayed unit is "Vrms/rtHz". For general units, the unit abbreviation is shown followed by "rms/rtHz".

The Band Density Calculation only controls the readout format for Normal and Fixed markers. For Delta markers, see [“Band Power and Delta Markers”](#) on page 1800.

Key Path:	Marker Function, Band/Interval Power
Mode:	VSA, LTE, LTETDD, IDEN
Measurement:	<meas>:=VECTor ADEMod DDEMod W11A W11B EVM IPOWER IDEMod MOTotalk

Remote Command:	:CALCulate:<meas>:MARKer [1] 2 3 4 5 6 7 8 9 10 11 12 :FU Nction:BDENsity:CTYPe MEAN RMS :CALCulate:<meas>:MARKer [1] 2 3 4 5 6 7 8 9 10 11 12 :FU Nction:BDENsity:CTYPe?
Example:	CALC:VECT:MARK1:FUNC:BDEN:CTYP RMS CALC:VECT:MARK1:FUNC:BDEN:CTYP?
Preset:	MEAN
State Saved:	Saved in instrument state.
Range:	Mean RMS
Initial S/W Revision:	Prior to A.02.00
Modified at S/W Revision:	A.02.00
Help Map ID:	25749

Band Adjust

Enables you to define the bandwidth around the marker. The band is always centered on the marker position. Entering the menu always sets Band/Interval Span as the active function.

Key Path:	Marker Function
Mode:	VSA, LTE, LTETDD, IDEN
Initial S/W Revision:	Prior to A.02.00
Modified at S/W Revision:	A.02.00
Help Map ID:	25880

Band/Interval Center

Enables you to define the center of the band. That is, it enables you to adjust the marker position in absolute units (regardless of whether the marker mode is Normal or Delta).

Key Path:	Marker Function, Band Adjust
Mode:	VSA, LTE, LTETDD, IDEN
Measurement:	<meas>:=VECTor ADEMod DDEMod W11A W11B EVM IPOWER IDEMod MOTotalk
Remote Command:	:CALCulate:<meas>:MARKer [1] 2 3 4 5 6 7 8 9 10 11 12 :FU Nction:BAND:CENTer <real> :CALCulate:<meas>:MARKer [1] 2 3 4 5 6 7 8 9 10 11 12 :FU Nction:BAND:CENTer?
Example:	CALC:VECT:MARK2:FUNC:BAND:CENT 1.23E+09 CALC:VECT:MARK2:FUNC:BAND:CENT?

Common Measurement Functions 2

Preset:	Center of screen
State Saved:	Saved in instrument state.
Min:	-9.9E+37
Max:	9.9E+37
Initial S/W Revision:	Prior to A.02.00
Modified at S/W Revision:	A.02.00
Help Map ID:	25712

Band/Interval Span

Sets the width of the span for the selected marker. This function defines the span of frequencies or time. The marker position does not change when you adjust the span.

Key Path:	Marker Function, Band Adjust
Mode:	VSA, LTE, LTETDD, IDEN
Measurement:	<meas>:=VECTor ADEMod DDEMod W11A W11B EVM IPOWer IDEMod MOTotalk
Remote Command:	:CALCulate:<meas>:MARKer [1] 2 3 4 5 6 7 8 9 10 11 12 :FU Nction:BAND:SPAN <real> :CALCulate:<meas>:MARKer [1] 2 3 4 5 6 7 8 9 10 11 12 :FU Nction:BAND:SPAN?
Example:	CALC:VECT:MARK2:FUNC:BAND:SPAN 1.23E+06 CALC:VECT:MARK2:FUNC:BAND:SPAN?
Preset:	When marker turned on, 1/20th of current span or displayed time length.
State Saved:	Saved in instrument state.
Min:	-9.9E+37
Max:	9.9E+37
Initial S/W Revision:	Prior to A.02.00
Modified at S/W Revision:	A.02.00
Help Map ID:	25750

Band/Interval Left

Enables you to adjust the left side of the band. In order to remain centered in the band, the marker position must also change as you change the left edge. The right edge is unaffected.

Key Path:	Marker Function, Band Adjust
Mode:	VSA, LTE, LTETDD, IDEN

Measurement:	<meas>:=VECTor ADEMod DDEMod W11A W11B EVM IPOWER IDEMod MOTotalk
Remote Command:	:CALCulate:<meas>:MARKer [1] 2 3 4 5 6 7 8 9 10 11 12 :FUNction:BAND:LEFT <real> :CALCulate:<meas>:MARKer [1] 2 3 4 5 6 7 8 9 10 11 12 :FUNction:BAND:LEFT?
Example:	CALC:VECT:MARK2:FUNC:BAND:LEFT 1.23E+06 CALC:VECT:MARK2:FUNC:BAND:LEFT?
Couplings:	Changes marker X to keep the marker centered in the band.
Preset:	When marker turned on, 1/40th of current span or displayed time length left of the marker position.
State Saved:	Saved in instrument state.
Min:	-9.9E+37
Max:	9.9E+37
Initial S/W Revision:	Prior to A.02.00
Modified at S/W Revision:	A.02.00
Help Map ID:	25751

Band/Interval Right

Enables you to adjust the right side of the band. In order to remain centered in the band, the marker position must also change as you change the right edge. The left edge is unaffected.

Key Path:	Marker Function, Band Adjust
Mode:	VSA, LTE, LTETDD, IDEN
Measurement:	<meas>:=VECTor ADEMod DDEMod W11A W11B EVM IPOWER IDEMod MOTotalk
Remote Command:	:CALCulate:<meas>:MARKer [1] 2 3 4 5 6 7 8 9 10 11 12 :FUNction:BAND:RIGHT <real> :CALCulate:<meas>:MARKer [1] 2 3 4 5 6 7 8 9 10 11 12 :FUNction:BAND:RIGHT?
Example:	CALC:VECT:MARK2:FUNC:BAND:RIGHT 1.23E+06 CALC:VECT:MARK2:FUNC:BAND:RIGHT?
Couplings:	Changes marker X to keep the marker centered in the band.
Preset:	When marker turned on, 1/40th of current span or displayed time length right of the marker position.
State Saved:	Saved in instrument state.
Min:	-9.9E+37

Common Measurement Functions 2

Max:	9.9E+37
Initial S/W Revision:	Prior to A.02.00
Modified at S/W Revision:	A.02.00
Help Map ID:	25752

Band Power and Delta Markers

When either a Delta marker or its reference has a band power function turned on, the Delta marker readout always shows a ratio calculation. This enables you to perform common calculations like carrier to noise ratio or adjacent channel power ratio. The form of the ratio depends on the main marker function calculation type (Mean or RMS). If the main marker function calculation type is Mean, then when you change the marker to Delta the result is a power ratio. If the main marker function calculation type is RMS, then the Delta marker result is a voltage ratio. (If the main marker band power function is off, then the form of the ratio depends on the reference marker calculation type: If it is Mean you get a power ratio and if it is RMS you get a voltage ratio.)

For example, if the main marker function is Band/Interval Power with a calculation type of Mean and the reference marker function is Band/Interval Power with a calculation type of RMS, then the Delta marker shows the ratio of the main marker "Band/Interval Power Mean" value to the reference marker "Band/Interval Power Mean" (not RMS) value.

A dimensionless ratio (for example, Volt/Volt or Watt/Watt) is shown with units of "x". The marker function calculation type indicates whether the ratio is voltage or power (see above). A dimensionless power ratio is shown with units of dB if the trace format is Log Mag (dB).

If the reference marker function is Band/Interval Density and the main marker is either Band/Interval Power or its function is turned off, then the ratio is not dimensionless, but has units of Hz (or dB-Hz) for power calculations or rHz for voltage calculations. When the main marker function is Band/Interval Density and the reference is either Band/interval Power or its function is off, the units are /Hz (or dB/Hz) for power calculations or /rHz for voltage calculations.

Key Path:	Marker Function
Mode:	VSA, LTE, LTETDD, IDEN
Initial S/W Revision:	Prior to A.02.00
Modified at S/W Revision:	A.02.00
Help Map ID:	0

Meas Setup

Accesses a menu of keys that select measurement functions for VSA based measurements.

Key Path:	Front Panel
Mode:	VSA, LTE, LTETDD, IDEN
Initial S/W Revision:	Prior to A.02.00

Modified at S/W Revision:	A.02.00
Help Map ID:	25933

Avg Number

Enables you to turn averaging on or off, and set the number of scans (time records) whose measurement results are averaged. Averaging can be done over spectrum results (RMS) or over time records (Time). A third kind of pseudo averaging displays the maximum value seen at each spectral line over the specified number of scans. See [“Average Type” on page 1803](#) for a more detailed description of how measurement results are averaged. For RMS or Time averaging, the process is similar. Each time an averaged result is displayed, it is the sum of the individual results taken since measurement restart, divided by the number of scans. (For Max averaging, there is no actual summation or division.) The Measurement Bar shows the number of scans and the Avg number setting. For example, if 4 scans have been taken and the Avg Number is 10, the Meas Bar shows "4/10". The measurement continues to take new scans until the number of scans is equal to the Avg Number setting, at which time the measurement stops if Sweep control is in Single Mode. Otherwise, the measurement continues, and the Average Mode setting determines how successive scans are added to the averaged result. See [“Average Mode” on page 1802](#) for details.

Key Path:	Meas Setup, More
Mode:	VSA, LTE, LTETDD, IDEN
Measurement:	<meas>:=VECTor ADEMod DDEMod W11A W11B EVM IPOWER IDEMod MOTotalk
Remote Command:	[:SENSE] : <meas> : AVERage : COUNT <integer> [:SENSE] : <meas> : AVERage : COUNT ? [:SENSE] : <meas> : AVERage [:STATE] OFF ON 0 1 [:SENSE] : <meas> : AVERage [:STATE] ?
Example:	VECT: AVER: COUN 20 VECT: AVER: COUN ? VECT: AVER ON VECT: AVER ?
Notes:	If an averaged measurement is idle because the scan count is equal to the Avg Number and the Avg Number is increased, the measurement resumes until the new number of averages is satisfied.
Preset:	10 OFF IPOW: ON
State Saved:	Saved in instrument state.
Min:	1
Max:	2147483647

Common Measurement Functions 2

Initial S/W Revision:	Prior to A.02.00
Modified at S/W Revision:	A.02.00
Help Map ID:	25781

Average Mode

Determines what happens when the Sweep Mode is Continuous and the number of scans processed exceeds the Average Number (see “Avg Number” on page 1801). If the Sweep Control is in Single mode, this setting has no affect.

When averaging is on and the number of scans is less than or equal to the Avg Number setting, a linear average is calculated as explained in the Avg Number topic. After the scan count exceeds the Avg Number setting, the measurement continues to take new scans. The Measurement Bar average indicator shows ">N/N" where N is the Avg Number.

If Average Mode is Exp then new results are averaged in exponentially. In other words, each succeeding average is the weighted sum of the previous average, weighted by $(N-1)/N$, and the new measurement, weighted by $1/N$, where N is the Average Number setting. (For Max averaging, no weighting occurs; the result continues to be the max value seen at each spectral line for every previous scan since measurement restart.)

If Average Mode is Repeat, then the average buffer is cleared after the average counter reaches the Average Number setting, and the average counter is reset to 0. Then a new set of averages is taken. The measurement bar therefore continues to show "k/N" in the average indicator, where k is the number of scans since the last time the average buffer was cleared and N is the Avg Number. The averaged result is the sum of the last k results divided by k. (For Max averaging, no sum or division takes place, but the buffer is cleared as stated above. The averaged result is the max value seen over the last k scans.)

Key Path:	Meas Setup
Mode:	VSA, LTE, LTETDD, IDEN
Measurement:	<meas>:=VECTor ADEMod DDEMod W11A W11B EVM IPOWer IDEMod MOTotalk
Remote Command:	[:SENSE] :<meas>:AVERAge:TCONtrol EXPonential REPEAT [:SENSE] :<meas>:AVERAge:TCONtrol?
Example:	VECT:AVER:TCON EXP VECT:AVER:TCON?
Preset:	EXP
State Saved:	Saved in instrument state.
Range:	Exp Repeat
Initial S/W Revision:	Prior to A.02.00
Modified at S/W Revision:	A.02.00
Help Map ID:	25782

Average Setup

Accesses a menu enabling you to set Averaging parameters for all VSA based measurements.

Key Path:	Meas Setup
Mode:	VSA, LTE, LTETDD, IDEN
Initial S/W Revision:	Prior to A.02.00
Modified at S/W Revision:	A.02.00
Help Map ID:	25899

Average Type

Enables you to select the type of averaging. The following table shows what measurement results are averaged for each average type. This applies in the Vector Measurement.

Average Type	Measurement result averaged.
RMS	Spectrum, PSD: Power is averaged for each spectral line (i.e., this is a mean-square average of voltage). For the Spectrum result only, if the display transform is linear or real, the RMS result is displayed.
Time	Main Time: Individual time samples in the current time record are averaged vectorially (not RMS) with corresponding points in previous time records. See Main Time for more details.
Max	Spectrum, PSD: Not strictly an average. For each spectral line, power from the current measurement is compared to the average buffer value and the maximum is kept in the average buffer.

Some measurement results are inherently averaged, and are not affected by the Average controls. These are: CCDF, CDF, and PDF. They average continuously until the next measurement restart.

Key Path:	Meas Setup, Average Setup
Mode:	VSA, LTE, LTETDD, IDEN
Measurement:	<meas>:=VECTor ADEMod DDEMod W11A W11B EVM IPOWER IDEMod MOTotalk
Remote Command:	[:SENSE] : <meas> : AVERage : TYPE RMS TIME MAXimum [:SENSE] : <meas> : AVERage : TYPE?
Example:	VECT: AVER: TYPE RMS VECT: AVER: TYPE?
Preset:	RMS
State Saved:	Saved in instrument state.
Range:	RMS Time Max

Common Measurement Functions 2

Initial S/W Revision:	Prior to A.02.00
Modified at S/W Revision:	A.02.00
Help Map ID:	25783

Fast Average

Controls the display of average data. If fast averaging is off, then the display is updated after each time record is processed. If fast averaging is on, then the display is only updated after every M records, where M is the Update Rate (see “Update Rate” on page 1804). For example, if the fast average count is 10, then the running average is only displayed every 10th time record.

Key Path:	Meas Setup, Average Setup
Mode:	VSA, LTE, LTETDD, IDEN
Measurement:	<meas>:=VECTor ADEMod DDEMod W11A W11B EVM IPOWer IDEMod MOTotalk
Remote Command:	[:SENSE] :<meas>:AVERage:FAST OFF ON 0 1 [:SENSE] :<meas>:AVERage:FAST?
Example:	VECT:AVER:FAST ON VECT:AVER:FAST?
Preset:	OFF
State Saved:	Saved in instrument state.
Range:	On Off
Initial S/W Revision:	Prior to A.02.00
Modified at S/W Revision:	A.02.00
Help Map ID:	25784

Update Rate

Controls how often the display updates when fast averaging is turned on. If the Fast Averaging State is MAX then the display is updated only after the full Average Count is reached. Otherwise, the display is updated whenever the average count is a multiple of the Update Rate.

Key Path:	Meas Setup, More, Average Setup
Mode:	VSA, LTE, LTETDD, IDEN
Measurement:	<meas>:=VECTor ADEMod DDEMod W11A W11B EVM IPOWer IDEMod MOTotalk

Remote Command:	[:SENSe] :<meas>:AVERage:FAST:URATe <integer> [:SENSe] :<meas>:AVERage:FAST:URATe? [:SENSe] :<meas>:AVERage:FAST:URATe:AUTO OFF ON 0 1 [:SENSe] :<meas>:AVERage:FAST:URATe:AUTO?
Example:	VECT:AVER:FAST:URAT 20 VECT:AVER:FAST:URAT? VECT:AVER:FAST:URAT:AUTO ON VECT:AVER:FAST:URAT:AUTO?
Preset:	10 ON
State Saved:	Saved in instrument state.
Min:	1
Max:	2147483647
Initial S/W Revision:	Prior to A.02.00
Modified at S/W Revision:	A.02.00
Help Map ID:	25785

PhNoise Opt

Enables you to adjust the LO phase noise optimization to give better close-in phase noise or better wide-offset phase noise. The definition of what frequency offsets constitute close in or wide offset varies with hardware. (The selection keys provide hardware-specific prompts.)

Key Path:	Meas Setup
Mode:	VSA, WIMAXFIXED
Measurement:	<meas>:=VECTor ADEMod DDEMod W11A W11B EVM
Remote Command:	[:SENSe] :<meas>:FREQuency:SYNTHeSis [:STATE] 1 2 [:SENSe] :<meas>:FREQuency:SYNTHeSis [:STATE] ?
Example:	VECT:FREQ:SYNT 1 VECT:FREQ:SYNT?

Common Measurement Functions 2

Notes:	<p>Parameter key:</p> <p>1 - optimizes phase noise for close-in frequencies</p> <p>2 - optimizes phase noise for wide-offset frequencies</p> <p>The softkey shows the options more explicitly. For MXA/EXA, the selection keys show the options:</p> <p>Best Close-in Noise [offset < 20 kHz]</p> <p>Best Wide-offset BNoise [offset > 30 kHz]</p> <p>For PXA the options are:</p> <p>Best Close-in nNoise [offset < 140 kHz]</p> <p>Best Wide-offset ãNoise [offset > 160 kHz]</p>
Preset:	<p>all VXA measurements: Best Wide-offset Æ Noise</p> <p>WIMAXFIXED EVM measurement: Best Close-in Ù Noise</p>
State Saved:	Saved in instrument state.
Initial S/W Revision:	A.04.00
Help Map ID:	30230

Best Close-in F Noise

Optimizes LO phase noise for smaller offsets from the carrier at the expense of phase noise farther out. For MXA, close in means offsets < 20 kHz; for PXA, it means offsets < 140 kHz.

Key Path:	Meas Setup, PhNoise Opt
Mode:	VSA, WIMAXFIXED
Example:	VECT:FREQ:SYNT 1 VECT:FREQ:SYNT?
Readback:	Close-in
Initial S/W Revision:	A.04.00
Help Map ID:	30231

Best Wide-offset F Noise

Optimizes LO phase noise for wider offsets from the carrier at the expense of phase noise closer in. For MXA, wide-offset means offsets > 30 kHz; for PXA, it means offsets > 160 kHz.

Key Path:	Meas Setup, PhNoise Opt
Mode:	VSA, WIMAXFIXED
Example:	VECT:FREQ:SYNT 2 VECT:FREQ:SYNT?

Readback:	Wide-offset
Initial S/W Revision:	A.04.00
Help Map ID:	30232

Peak Search

Displays a menu that enables markers to be easily moved among peaks on a trace and also performs the peak search function. Pressing Peak Search also makes the selected marker's X position the active function.

The peak search function causes the marker to move to the highest point in the trace. The highest point is the point with the largest y-axis value in the current trace format. If the format is complex (vector or constellation) then the point with the highest magnitude is chosen.

Pressing the Peak Search hard key always performs a Peak Search, with one exception: if the Peak Search menu is not showing but the selected marker is on (Normal, Delta, or Fixed), then pressing the Peak Search hardkey only displays the Peak Search menu. This enables you to select one of the other peak search functions without disturbing the selected marker's position. If you want to perform a peak search in this case, press the Peak Search hardkey again.

If the selected marker is Off, then pressing the Peak Search hardkey once not only shows the menu, but it turns on the selected marker in Normal mode, assigns it to the selected trace, and performs a peak search.

If any peak search SCPI command is invoked on a marker that is Off, the marker is first turned on in Normal mode and assigned to the selected trace. Then the peak search is performed.

Key Path:	Front Panel
Mode:	VSA, LTE, LTETDD, IDEN
Measurement:	<meas>:=VECTor ADEMod DDEMod W11A W11B EVM IPOWer IDEMod MOTotalk
Remote Command:	:CALCulate:<meas>:MARKer [1] 2 3 4 5 6 7 8 9 10 11 12 :MA Ximum
Example:	CALC:VECT:MARK2:MAX
Notes:	There is no softkey for this function. Instead, you press the Peak Search hardkey twice. (Pressing it once is sufficient if the Peak Search menu is showing, but twice guarantees that the function is invoked) If peak search function is not invoked (because the response to pressing the hardkey was only to show the menu) then the following message is shown: "Press Peak Search again to perform a Peak Search."
Initial S/W Revision:	Prior to A.02.00
Modified at S/W Revision:	A.02.00
Help Map ID:	25865

Common Measurement Functions 2

Next Peak (Next Lower Amptd)

Moves the marker to the peak next lower in Y value than the peak it is currently on. If the format is complex (vector or constellation) then the marker moves to the closest point that has a lower magnitude than the marker's current position. If this function is invoked via SCPI on a marker that is off, the result is the same as if you sent a Peak Search command.

Key Path:	Peak Search
Mode:	VSA, LTE, LTETDD, IDEN
Measurement:	<meas>:=VECTor ADEMod DDEMod W11A W11B EVM IPOWer IDEMod MOTotalk
Remote Command:	:CALCulate:<meas>:MARKer [1] 2 3 4 5 6 7 8 9 10 11 12 :MA Ximum: NEXT
Example:	CALC:VECT:MARK2:MAX:NEXT
Initial S/W Revision:	Prior to A.02.00
Modified at S/W Revision:	A.02.00
Help Map ID:	25741

Next Higher Amptd

Moves the marker to the peak next higher in Y value than the peak it is currently on. If the format is complex (vector or constellation) then the marker moves to the closest point that has a higher magnitude than the marker's current position. If this function is invoked via SCPI on a marker that is off, the result is the same as if you sent a Peak Search command.

Key Path:	Peak Search
Mode:	VSA, LTE, LTETDD, IDEN
Measurement:	<meas>:=VECTor ADEMod DDEMod W11A W11B EVM IPOWer IDEMod MOTotalk
Remote Command:	:CALCulate:<meas>:MARKer [1] 2 3 4 5 6 7 8 9 10 11 12 :MA Ximum: PREVIOUS
Example:	CALC:VECT:MARK2:MAX:PREV
Initial S/W Revision:	Prior to A.02.00
Modified at S/W Revision:	A.02.00
Help Map ID:	25742

Next Right

Moves the marker to the next peak to the right of its current position. If the format is complex (vector or constellation) then the marker moves forward in time to the next peak. If this function is invoked via SCPI on a marker that is off, the result is the same as if you sent a Peak Search command.

A valid peak is one for which the displayed Y-axis values drop monotonically on both sides of the local

maximum at least 4% of the distance between the top and bottom of the display grid before the values begin to rise again.

Key Path:	Peak Search
Mode:	VSA, LTE, LTETDD, IDEN
Measurement:	<meas>:=VECTor ADEMod DDEMod W11A W11B EVM IPOWER IDEMod MOTotalk
Remote Command:	:CALCulate:<meas>:MARKer [1] 2 3 4 5 6 7 8 9 10 11 12 :MAXimum:RIGHT
Example:	CALC:VECT:MARK2:MAX:RIGH
Initial S/W Revision:	Prior to A.02.00
Modified at S/W Revision:	A.02.00
Help Map ID:	25743

Next Left

Moves the marker to the next peak to the left of its current position. If the format is complex (vector or constellation) then the marker moves back in time to the next peak. If this function is invoked via SCPI on a marker that is off, the result is the same as if you sent a Peak Search command.

A valid peak is one for which the displayed Y-axis values drop monotonically on both sides of the local maximum at least 4% of the distance between the top and bottom of the display grid before the values begin to rise again.

Key Path:	Peak Search
Mode:	VSA, LTE, LTETDD, IDEN
Measurement:	<meas>:=VECTor ADEMod DDEMod W11A W11B EVM IPOWER IDEMod MOTotalk
Remote Command:	:CALCulate:<meas>:MARKer [1] 2 3 4 5 6 7 8 9 10 11 12 :MAXimum:LEFT
Example:	CALC:VECT:MARK2:MAX:LEFT
Initial S/W Revision:	Prior to A.02.00
Modified at S/W Revision:	A.02.00
Help Map ID:	25744

Mkr -> CF (Center Frequency)

This key is a duplicate of the key of the same name in the Mkr -> menu. It is placed in this menu as a convenience. See “[Marker -> \(Marker To\)](#)” on page 1789.

Key Path:	Peak Search
-----------	--------------------

Common Measurement Functions 2

Mode:	VSA, LTE, LTETDD, IDEN
Initial S/W Revision:	Prior to A.02.00
Modified at S/W Revision:	A.02.00
Help Map ID:	Use 25869

Continuous Peak Search

Turns on Continuous Peak Search for the selected marker. This function can be turned on for any marker independently of any other marker. This function moves the marker to the highest point on the trace each time the trace is updated. If the SCPI command refers to a marker that is off, it is turned on in Normal mode.

It is possible to have Couple Markers and Continuous Peak Search both on. If this is the case, it is recommended that Continuous Peak search be turned on for only one marker in any tracking set (that is, any set of markers with the same or equivalent domain). Otherwise, conflicts over marker position can arise that cause erratic marker movement.

Key Path:	Peak Search
Mode:	VSA, LTE, LTETDD, IDEN
Measurement:	<meas>:=VECTor ADEMod DDEMod W11A W11B EVM IPOWer IDEMod MOTotalk
Remote Command:	:CALCulate:<meas>:MARKer [1] 2 3 4 5 6 7 8 9 10 11 12 : CP Search [: STATe] ON OFF 1 0 :CALCulate:<meas>:MARKer [1] 2 3 4 5 6 7 8 9 10 11 12 : CP Search [: STATe] ?
Example:	CALC:VECT:MARK1:CPS ON
Couplings:	The Continuous Peak Search key is grayed out when the selected marker is a Fixed marker. Also, if Continuous Peak Search is on and the selected marker becomes a fixed marker, then Continuous Peak Search is turned off and the key grayed out. Continuous Peak Search is turned off when the selected marker is turned off.
Preset:	OFF
State Saved:	Saved in instrument state.
Range:	Off On
Initial S/W Revision:	Prior to A.02.00
Modified at S/W Revision:	A.02.00
Help Map ID:	25745

Min Search

Moves the marker to the lowest Y value on the trace. If the format is complex (vector or constellation) then the marker moves to the lowest value in magnitude. If the SCPI command refers to a marker that is

off, it is first turned on in Normal mode and then set on the minimum point.

Key Path:	Peak Search
Mode:	VSA, LTE, LTETDD, IDEN
Measurement:	<meas>:=VECTor ADEMod DDEMod W11A W11B EVM IPOWer IDEMod MOTotalk
Remote Command:	:CALCulate:<meas>:MARKer [1] 2 3 4 5 6 7 8 9 10 11 12 :MI Nimum
Example:	CALC:VECT:MARK2:MIN
Initial S/W Revision:	Prior to A.02.00
Modified at S/W Revision:	A.02.00
Help Map ID:	25746

Mkr -> Ref Lvl (Reference Level)

Sets the Y axis reference value equal to the selected marker's Y value. For example, if the reference position is at the top of the screen, the whole trace is moved up so that the marker appears at the top of the screen. Note that this is a display scaling function only. The input range remains the same.

Key Path:	Peak Search
Mode:	VSA, LTE, LTETDD, IDEN
Initial S/W Revision:	Prior to A.02.00
Modified at S/W Revision:	A.02.00
Help Map ID:	25867

Recall

Operation of this key is identical across several measurements. For more details about this key, see [Recall@2637@i](#).

Key Path:	Front-Panel key
Help Map ID:	0

Key and Command Descriptions

State

Key Path:	Recall
Mode:	VSA, LTE, LTETDD, IDEN

Common Measurement Functions 2

Help Map ID:	Use 2638
--------------	----------

Data (Import)

Key Path:	Recall
Mode:	VSA, LTE, LTETDD, IDEN
Help Map ID:	Use 3480

Import Trace Data

Enables you to import previously saved trace data into a Data Register and optionally display it. Selecting this key displays a menu that enables you to select the destination data register, and also enables you to choose whether or not to display the recalled data in the currently selected trace. After making these selections, select Open... and use the file dialog to select the file you want to recall.

Recalling trace data into an already used Data Register overwrites the previous data. If the data register is displayed on any trace, the display is updated to reflect the new data.

The SCPI command

```
:MMEM:LOAD:TRAC:DATA D1|D2|D3|D4|D5|D6,<filename>
```

recalls data into a specified register, but does not display it in the selected trace. Use the command

```
:DISP:<meas>:TRAC<n>:FEED D1|D2|D3|D4|D5|D6
```

to display the register in the desired trace.

It is possible to recall trace data saved by other VXA measurements, or measurements made using the LTE, LTETDD, iDEN, or 89601 applications.

Key Path:	Recall, Data (Import)
Mode:	VSA, LTE, LTETDD, IDEN
Remote Command:	:MMEMory:LOAD:TRACe:DATA D1 D2 D3 D4 D5 D6, <filename> [, CSV TXT SDF MAT4 MAT HDF5 BIN]
Example:	:MMEM:LOAD:TRAC:DATA D1,"Trc1.txt",TXT

Notes:	<p>The Open: dialog box has the following filter options when you are recalling trace data::</p> <ul style="list-style-type: none"> • CSV (Comma delimited) (*.csv) • SDF (Fast) (*.sdf;*.dat) • Text (Tab delimited) (*.txt) <p>The file must have the same format as that created by the Export Recorded Data command.</p> <p>The SCPI command has an optional file format parameter. If you do not include this parameter in the SCPI command, the file format is determined by the file name extension. If no file extension is recognized, the file is scanned to determine the format.</p> <p>If you are not licensed to recall a particular file type, then error –203.9010 is returned. If the file format cannot be determined or the file cannot be recalled successfully, then error –250.5290 is returned. If the recall is successful, then advisory 0.1600 is shown.</p>
State Saved:	No
Readback:	Data 1 Data 2 Data 3 Data 4 Data 5 Data 6
Help Map ID:	30195

Data 1

Selects the Data 1 register as the destination for the imported data.

Key Path:	Recall, Data (Import), Trace (to)
Mode:	VSA, LTE, LTETDD, IDEN
Help Map ID:	30196

Data 2

Selects the Data 2 register as the destination for the imported data.

Key Path:	Recall, Data (Import), Trace (to)
Mode:	VSA, LTE, LTETDD, IDEN
Help Map ID:	30197

Data 3

Selects the Data 3 register as the destination for the imported data.

Key Path:	Recall, Data (Import), Trace (to)
Mode:	VSA, LTE, LTETDD, IDEN
Help Map ID:	30198

Common Measurement Functions 2

Data 4

Selects the Data 4 register as the destination for the imported data.

Key Path:	Recall, Data (Import), Trace (to)
Mode:	VSA, LTE, LTETDD, IDEN
Help Map ID:	30199

Data 5

Selects the Data 5 register as the destination for the imported data..

Key Path:	Recall, Data (Import), Trace (to)
Mode:	VSA, LTE, LTETDD, IDEN
Help Map ID:	30200

Data 6

Selects the Data 6 register as the destination for the imported data.

Key Path:	Recall, Data (Import), Trace (to)
Mode:	VSA, LTE, LTETDD, IDEN
Help Map ID:	30201

Display in Selected Trace

Enables you to select whether the recalled trace data is displayed in the current Trace.

Key Path:	Recall, Data (Import), Trace (to)
Mode:	VSA, LTE, LTETDD, IDEN
State Saved:	No
Help Map ID:	30202

Open ...

Key Path:	Recall, Data (Import)
Mode:	VSA, LTE, LTETDD, IDEN
Help Map ID:	Use 3654

Save

See Save@2600@i for more information.

Key Path:	Front-Panel key
Help Map ID:	0

Key and Command Descriptions

State

Key Path:	Save
Mode:	VSA, LTE, LTETDD, IDEN
Help Map ID:	Use 2601

Data (Export)

Key Path:	Save
Mode:	VSA, LTE, LTETDD, IDEN
Help Map ID:	Use 2611

Export Trace Data

Enables you to export trace data with (optional) associated headers. Selecting this key displays a menu that enables you to choose which Trace to save (default is the selected Trace) and whether or not to save headers with the data. The header information is used by the VXA application when saved trace data is recalled, and enables it to be displayed with the same formatting and scaling that it had when saved. If headers are not saved, the scaling and format are set to default values when the trace is recalled. After making these selections, press Save As... and use the file dialog to choose a file name and format for the saved data.

Trace data can be exported in several different formats. Text and comma-separated variable (CSV) formats are useful for viewing the data or importing it to a spreadsheet program. The other formats are binary and thus more compact. Trace data files can be recalled for viewing into other VXA, LTE, LTETDD, iDEN, or 89601 measurements.

Key Path:	Save, Data (Export)
Mode:	VSA, LTE, LTETDD, IDEN
Remote Command:	:MMEMory:STORe:TRACe:DATA TRACE1 TRACE2 TRACE3 TRACE4 TRACE5 TRACE6, "<filename>" [, CSV TXT SDF MAT4 MAT HDF5 BIN [, OFF ON 0 1]]
Example:	:MMEM:STOR:TRAC:DATA TRACE1,"TRC1.TXT",TXT,ON

Common Measurement Functions 2

Notes:	<p>The Save As... dialog box has the following format options when you are saving trace data:</p> <ul style="list-style-type: none"> • CSV (Comma delimited) (*.csv) • SDF (Fast) (*.sdf;*.dat) • Text (Tab delimited) (*.txt) <p>File format saved depends on selection. The appropriate file extension is appended to the filename if it is not supplied by the user.</p> <p>If the SCPI command includes just a file name, the file format is determined by the filename extension, which must be one of the choices above. *.sdf or an unrecognized extension chooses the SDF fast format. If the optional file format enumerator is included in the command, then this determines the file format and the file extension is ignored. The optional binary parameter determines if file headers are saved. The default is ON. If file headers are not wanted, use the optional “,OFF” parameter.</p> <p>The optional Boolean parameter determines whether headers are saved in the file. By default the headers are saved.</p> <p>If you are not licensed to save a particular file type, then error –203.9010 is returned. If an invalid file format is specified or the file cannot be saved successfully, then error –25x is returned. If the save is successful, then advisory 0.1500 is shown.</p>
State Saved:	No
Readback:	(Trace 1 Trace 2 Trace 3 Trace 4 Trace 5 Trace 6)(with without) headers
Help Map ID:	30207

Trace 1

Selects the Trace 1 register as the destination for the imported data.

Key Path:	Save, Data (Export), Trace
Mode:	VSA, LTE, LTETDD, IDEN
Help Map ID:	30208

Trace 2

Selects the Trace 2 register as the destination for the imported data.

Key Path:	Save, Data (Export), Trace
Mode:	VSA, LTE, LTETDD, IDEN
Help Map ID:	30209

Trace 3

Selects the Trace 3 register as the destination for the imported data.

Key Path:	Save, Data (Export), Trace
Mode:	VSA, LTE, LTETDD, IDEN
Help Map ID:	30210

Trace 4

Selects the Trace 4 register as the destination for the imported data.

Key Path:	Save, Data (Export), Trace
Mode:	VSA, LTE, LTETDD, IDEN
Help Map ID:	30211

Trace 5

Selects the Trace 5 register as the destination for the imported data.

Key Path:	Save, Data (Export), Trace
Mode:	VSA, LTE, LTETDD, IDEN
Help Map ID:	30212

Trace 6

Selects the Trace 6 register as the destination for the imported data.

Key Path:	Save, Data (Export), Trace
Mode:	VSA, LTE, LTETDD, IDEN
Help Map ID:	30213

Include Header

Enables you to select whether or not the saved trace data includes header information describing scaling, formatting, etc.

Key Path:	Save, Data (Export), Trace
Mode:	VSA, LTE, LTETDD, IDEN
State Saved:	No
Help Map ID:	30214

Common Measurement Functions 2

Save As . . .

Key Path:	Save, Data (Export)
Mode:	VSA, LTE, LTETDD, IDEN
Help Map ID:	Use 2617

Screen Image . . .

Key Path:	Save
Mode:	VSA, LTE, LTETDD, IDEN
Help Map ID:	Use 2620

SPAN X Scale

Displays a menu for selecting measurement span and also for scaling of the X axis.

Key Path:	Front Panel
Mode:	VSA, LTE, LTETDD, IDEN
Initial S/W Revision:	Prior to A.02.00
Modified at S/W Revision:	A.02.00
Help Map ID:	25890

Span

Controls the frequency span of the measurement. This is the full span that is displayed on a spectrum display. The actual IF bandwidth that the time record detects is 1.28 times the span. See [“FREQ Channel” on page 1770](#) for details on how this interacts with start, stop, and center frequencies.

Key Path:	SPAN X Scale
Mode:	VSA, IDEN
Remote Command:	[:SENSe] :FREQuency:SPAN <freq> [:SENSe] :FREQuency:SPAN?
Example:	FREQ:SPAN 10 MHZ FREQ:SPAN?
Couplings:	Start Freq and Stop Freq. See “FREQ Channel” on page 1770 for details.
Preset:	depends on span option
State Saved:	Saved in instrument state.

Min:	2 Hz
Max:	depends on span option
Initial S/W Revision:	Prior to A.02.00
Modified at S/W Revision:	A.02.00
Help Map ID:	25771

Full Span

Changes the span to the maximum available. The center frequency remains unchanged, regardless of whether the Frequency Annotation property is Start/Stop or Center/Span.

Key Path:	SPAN X Scale
Mode:	VSA, IDEN
Remote Command:	[:SENSe] :FREQuency :SPAN :FULL
Example:	FREQ:SPAN:FULL
Notes:	The label on the softkey gives the full span available, which depends on span option.
Couplings:	Changes span to maximum while keeping the center frequency constant. Start and Stop frequency are affected
Readback Text:	[25 MHz] If playing back a recording, list the recorded bandwidth here
Initial S/W Revision:	Prior to A.02.00
Modified at S/W Revision:	A.02.00
Help Map ID:	25772

Signal Track

Attempts to keep the largest magnitude signal in the center of the screen for a spectrum display. It is the equivalent of manually doing a single acquisition, doing a marker to peak search on a spectrum trace, then copying the marker position to the center frequency and repeating. (It is not necessary to be viewing a spectrum display for this function to work.)

Key Path:	SPAN X Scale
Mode:	VSA
Remote Command:	[:SENSe] :VECTor ADEMod :FREQuency :CENTer :TRACk OFF ON 0 1 [:SENSe] :VECTor ADEMod :FREQuency :CENTer :TRACk?
Example:	VECT:FREQ:CENT:TRAC ON VECT:FREQ:CENT:TRAC?
Couplings:	Unavailable if averaging is turned on.

Common Measurement Functions 2

Preset:	0
State Saved:	Saved in instrument state.
Range:	On Off
Initial S/W Revision:	Prior to A.02.00
Help Map ID:	25773

X Axis Scaling

By default, the X axis of a trace is scaled to show all the available data in the trace. (The exception is that in spectrum displays, the edges of the spectrum that can contain aliases are not shown by default.) However, the X axis can be manually scaled in order to zoom in on a subset of the X values, or to set the X scaling to more convenient numbers. X scaling can be changed even when a measurement is paused or completed, and the display is updated immediately using the existing trace data. No measurement parameters are affected and no new measurement is made. X scaling is unique to each trace.

Scaling is based on a reference position, which can be on the left of the grid, in the center, or on the right. The X reference value is assigned to this position. The X Width is the difference between the X value on the right side of the grid and the X value on the left. If the reference is in the center, the right and left are half of the X width away.

If X scaling is set such that the left or right axis boundary falls outside the X range of the available data, the trace is shown correctly on that portion of the display where it belongs.

For Vector displays (I-Q and Constellation), the X axis is actually perpendicular to the screen and the screen's horizontal axis is used for the real part of the Y values. In this case, the X scaling can still be used to only display a portion of the data. In the case of the X reference position, left means the least positive or most negative X value, and right means the most positive or least negative value. For example, when viewing a 10 ms time record of a QPSK signal, you could set the X reference position to left, the X reference value to 4 ms and the X width to 1 ms in order to view just the portion of the signal between 4 and 5 ms. This same portion would be shown if IQ format were chosen (even though the time axis is not visible in this case).

For Symbol tables, which are not graphed but displayed in alphanumeric, X scaling can also be used to display a portion of the complete data. For example, you can set the X reference position to left, the X reference value to 20 symbols, and the X width to 10 symbols to see symbols 20 through 30. If you then change the X reference position to center, you can see symbols 15 through 25, and if you change the X reference position to right, you can see symbols 10 through 20.

Annotation for the X axis is just below the grid on the left and right side. It is based on whether the X Scaling is Auto or Man. If it is Auto, then the left side is annotated with either "Center" or "Start", and the right side is annotated with either "Span" or "Stop" followed by the appropriate numbers and units. The Center/ Span pair is only used for Spectrum or PSD traces and only if the Freq Annotation property is Center/Span (see ["Freq Annotation" on page 1825](#)).



If X Scaling is Man, the annotation for the left side is "Left|Ctr|Right <x_reference_value> <unit>"

(depending on the X reference position) and on the right side the annotation is "Width <x_width> <unit>". Following is an illustration of two of these manual X scale annotations:

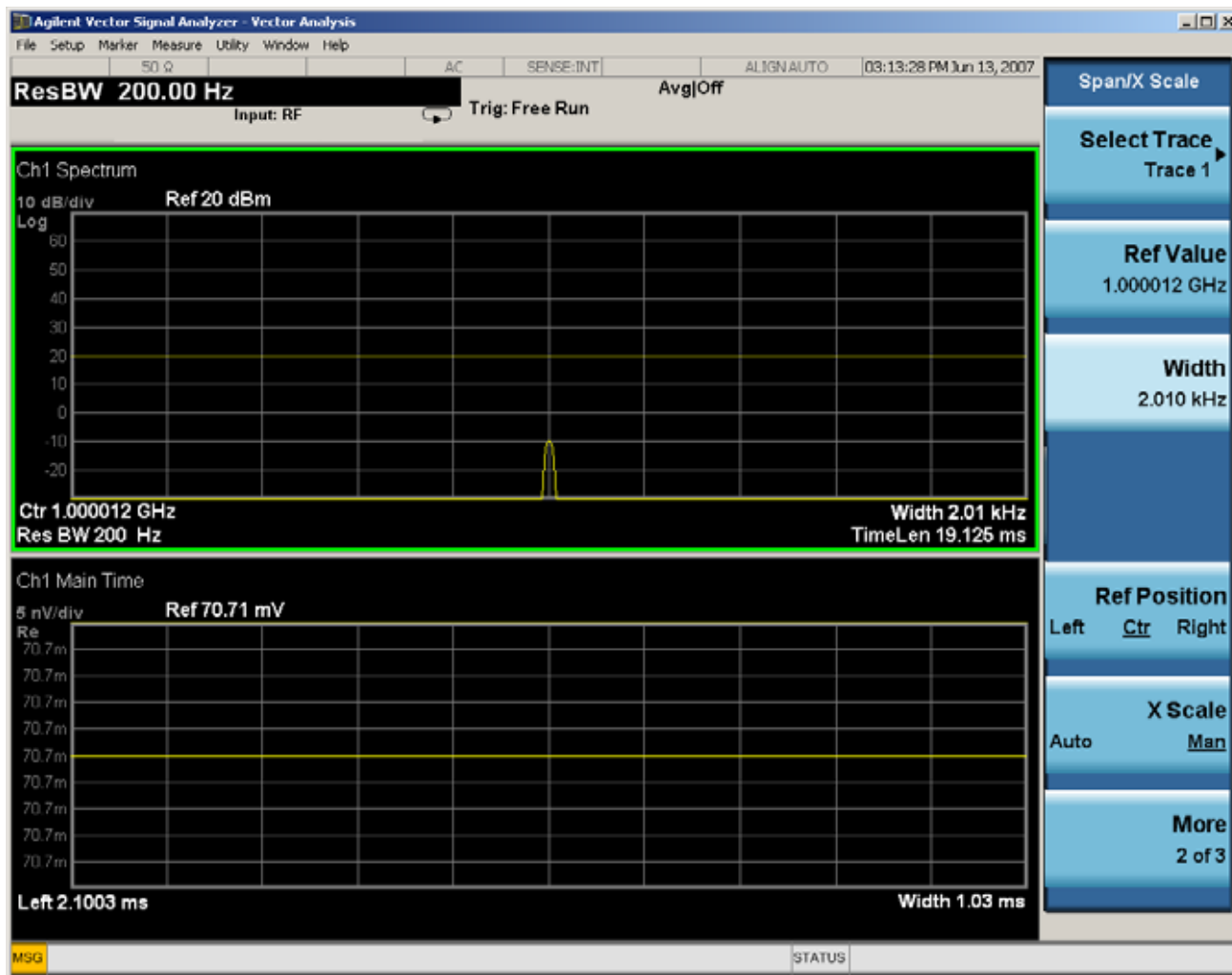

For Vector displays, the X axis annotation is replaced by annotation for the real part of the Y value - each annotation consisting of number followed by a unit (usually volts).

Key Path:	SPAN X Scale
Mode:	VSA, LTE, LTETDD, IDEN
Initial S/W Revision:	Prior to A.02.00
Modified at S/W Revision:	A.02.00
Help Map ID:	25891

Select Trace

This function is a duplicate of the same function found on the Trace/Detector menu. See the description

Common Measurement Functions 2

there for details. It is placed here to enable you to conveniently choose which trace the X scaling applies.

Key Path:	SPAN X Scale, X Axis Scaling
Mode:	VSA, LTE, LTETDD, IDEN
Initial S/W Revision:	Prior to A.02.00
Modified at S/W Revision:	A.02.00
Help Map ID:	Use 25779

X Scale

Causes the trace to display all available trace data when set to Auto. (Exception: the display of the outer edges of a spectrum that can contain aliases is governed by the All Frequency Points function setting – see below.) The annotation is updated as needed, but the X Reference Value and X Width keys are grayed out and not updated. When this function is set to Man, the X Reference Value and X Width softkey readbacks are updated with the current values.

Key Path:	SPAN X Scale
Mode:	VSA, LTE, LTETDD, IDEN
Measurement:	<meas>:=VECTor ADEMod DDEMod W11A W11B EVM IPOWer IDEMod MOTotalk
Remote Command:	:DISPlay:<meas>:TRACe [1] 2 3 4 :X [:SCALe] :COUPlE OFF ON 0 1 :DISPlay:<meas>:TRACe [1] 2 3 4 :X [:SCALe] :COUPlE?
Example:	:DISP:VECT:TRAC1:X:COUP ON DISP:VECT:TRAC1:X:COUP?
Couplings:	Forced to Man if X Reference Value or X Width is set by user.
Preset:	1
State Saved:	Saved in instrument state.
Range:	Auto Man
Initial S/W Revision:	Prior to A.02.00
Modified at S/W Revision:	A.02.00
Help Map ID:	25777

X Reference Value

Controls the X value of the selected trace at the chosen X Reference Position (see below). It has no effect on hardware input settings.

Key Path:	SPAN X Scale
Mode:	VSA, LTE, LTETDD, IDEN

Measurement:	<meas>:=VECTor ADEMod DDEMod W11A W11B EVM IPOWER IDEMod MOTotalk
Remote Command:	:DISPlay:<meas>:TRACe [1] 2 3 4 :X[:SCALE] :RLEVel <real> :DISPlay:<meas>:TRACe [1] 2 3 4 :X[:SCALE] :RLEVel?
Example:	DISP:VECT:TRAC:X:RLEV 1e9 DISP:VECT:TRAC:X:RLEV?
Couplings:	If X Scale is set to Auto, the X Reference Value is determined by the trace data and this key is grayed out.
Preset:	Depends on trace
State Saved:	Saved in instrument state.
Min:	-9.9E+37
Max:	9.9E+37
Initial S/W Revision:	Prior to A.02.00
Modified at S/W Revision:	A.02.00
Help Map ID:	25774

X Width

Sets the width of the X axis that is displayed for the selected trace. The X width can be set less than the Span for frequency-domain traces, enabling you to zoom in on just a portion of the measured values. Likewise, it can be less than time span covered by time-domain data. This plus the X Reference Value and X Reference Position control the range of X values that can be displayed on a trace. For example, if the X Reference position is Center, the X Reference value is 1 GHz and the X Width is 20 MHz.

Key Path:	SPAN X Scale
Mode:	VSA, LTE, LTETDD, IDEN
Measurement:	<meas>:=VECTor ADEMod DDEMod W11A W11B EVM IPOWER IDEMod MOTotalk
Remote Command:	:DISPlay:<meas>:TRACe [1] 2 3 4 :X[:SCALE] :SPAN <real> :DISPlay:<meas>:TRACe [1] 2 3 4 :X[:SCALE] :SPAN?
Example:	DISP:VECT:TRAC:X:SPAN 10e6 DISP:VECT:TRAC:X:SPAN?
Couplings:	If X Scale is set to Auto, the X Width is determined by the trace data and this key is grayed out.
Preset:	Depends on trace
State Saved:	Saved in instrument state.
Min:	-9.9E+37

Common Measurement Functions 2

Max:	9.9E+37
Initial S/W Revision:	Prior to A.02.00
Modified at S/W Revision:	A.02.00
Help Map ID:	25775

X Reference Position

Determines the position from which the X scaling is calculated for the selected trace. It can be set to the left side, center, or right side of the grid.

Key Path:	SPAN X Scale
Mode:	VSA, LTE, LTETDD, IDEN
Measurement:	<meas>:=VECTor ADEMod DDEMod W11A W11B EVM IPOWer IDEMod MOTotalk
Remote Command:	:DISPlay:<meas>:TRACe [1] 2 3 4:X[:SCALe]:RPOSition LEFT CENTer RIGHT :DISPlay:<meas>:TRACe [1] 2 3 4:X[:SCALe]:RPOSition?
Example:	DISP:VECT:TRAC1:X:RPOS LEFT DISP:VECT:TRAC1:X:RPOS?
Couplings:	If X Scale is set to Auto, the X Reference Position is determined by the trace data and this key is grayed out.
Preset:	CENT
State Saved:	Saved in instrument state.
Range:	Left Ctr Right
Initial S/W Revision:	Prior to A.02.00
Modified at S/W Revision:	A.02.00
Help Map ID:	25776

All Frequency Points

Spectrum trace data (and PSD) are based on the FFT algorithm. By default, the outer edges of the spectrum are not displayed because they can show spurious results that are aliases of real signals that are not completely filtered out by the IF filter. For example, in the case of a 1024 point FFT only 801 points are displayed. If you want to view the additional FFT points at the edges of spectral displays, turn this function on. It is global to all traces, not specific to a single trace.

Key Path:	SPAN X Scale
Mode:	VSA, LTE, LTETDD, IDEN
Measurement:	<meas>:=VECTor ADEMod DDEMod W11A W11B EVM IPOWer IDEMod MOTotalk

Remote Command:	:DISPlay:<meas>:AFPoints OFF ON 0 1 :DISPlay:<meas>:AFPoints?
Example:	DISP:VECT:AFP ON DISP:VECT:AFP?
Notes:	ac
Couplings:	Only applies if trace is showing Spectrum or PSD results.
Preset:	OFF
State Saved:	Saved in instrument state.
Range:	On Off
Initial S/W Revision:	Prior to A.02.00
Modified at S/W Revision:	A.02.00
Help Map ID:	25778

Freq Annotation

Controls how Spectrum and PSD traces are annotated when their X Scale is set to Auto. If Freq Annotation is set to Center/Span, the X-axes on windows containing frequency domain traces are labeled with the center frequency on the left and the span on the right. If the Freq Annotation is set to Start/Stop, then the start and stop frequencies appear in place of center and span. If the X Scale is manual, then this annotation style does not apply.

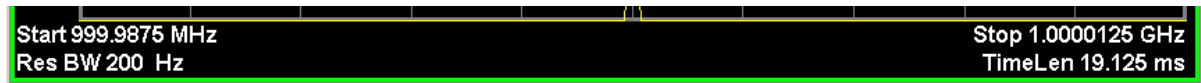
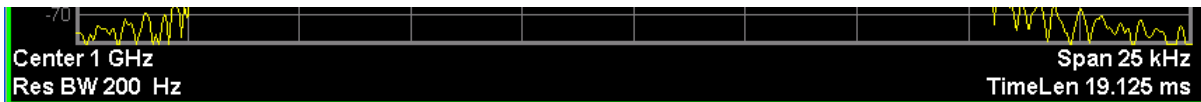

Key Path:	SPAN X Scale
Mode:	VSA, LTE, LTETDD, IDEN
Measurement:	<meas>:=VECTor ADEMod DDEMod W11A W11B EVM IPOWer IDEMod MOTotalk
Remote Command:	:DISPlay:<meas>:FANNotation CSPan SSTop :DISPlay:<meas>:FANNotation?
Example:	DISP:VECT:FANN CSP DISP:VECT:FANN?
Preset:	CSP
State Saved:	Saved in instrument state.

Common Measurement Functions 2

Range:	Center/Span Start/Stop
Initial S/W Revision:	Prior to A.02.00
Modified at S/W Revision:	A.02.00
Help Map ID:	25797

Copy X Scale

Copies the following X scaling information from the selected trace to another:

- X reference Position
- X Reference Value
- X Width
- X Scale (Auto/Man)

This is a front-panel only function.

Key Path:	SPAN X Scale, X Axis Scaling
Mode:	VSA, LTE, LTETDD, IDEN
Initial S/W Revision:	Prior to A.02.00
Modified at S/W Revision:	A.02.00
Help Map ID:	25892

Sweep/Control

Displays a menu that enables you to control time-related measurement parameters and to pause or resume the measurement.

Key Path:	Front Panel
Mode:	VSA
Initial S/W Revision:	A.01060 or later
Help Map ID:	25856

Main Time

Enables you to control the length of the overall time record used in the measurement. Note that the Gate function (see [“Gate” on page 1828](#)) enables you to analyze only a portion of the displayed Main Time. Time length and Res BW are related by the following equation:

$$\text{Res BW} = \text{ENBW} / T$$

where ENBW is the normalized effective noise bandwidth of the Window (see the FFT Window topic under BW for more details) and T is the time record length (in seconds).

Therefore, if you change Main Time, the Resolution bandwidth must also change, and vice versa.

Time record size (in sample points) can vary between 16 points and the full FFT size used for spectrum calculations. The FFT size is indirectly chosen by setting Freq Points (see “Freq Points” on page 1830) and is equal to $(\text{Freq Points} - 1) * 1.28$.

Main Time length (in seconds) is the time record size times the sample period. The sample period for the Main Time result is $1/(1.28 * \text{Span})$.

Limits:

The maximum Main Time length is:

$$\text{Max FFT size} / (1.28 * \text{Span}) = (409600) / \text{Span} \text{ if Freq points state parameter is set to Auto}$$

$$\text{FFT size} / (1.28 * \text{Span}) = (\text{Freq Points} - 1) / \text{Span} \text{ if Freq points parameter is manually set}$$

Note that the minimum Res BW is related to maximum Main Time length.

The minimum Main Time length is

$$16 \text{ points} / (1.28 * \text{Span}) = 12.5 / \text{Span}$$

See “Res BW” on page 1767 and “Res BW Coupling” on page 1768 for details on couplings that can change Main Time length due to Res BW changes.

Key Path:	Sweep Control
Mode:	VSA
Measurement:	<meas>:=VECTor ADEMod
Remote Command:	[:SENSE] : <meas> : SWEep : TIME <time> [:SENSE] : <meas> : SWEep : TIME?
Example:	VECT:SWE:TIME 3 MS VECT:SWE:TIME?
Notes:	This key is not available in measurements other than Vector or Analog Demod. The annotation is shown, however. In other measurements the time length is determined by number of symbols.
Couplings:	Affected by Res BW, Span, Freq Points, and Window. See “Res BW” on page 1767 and “Res BW Coupling” on page 1768 for details.
Preset:	12.75e-6
State Saved:	Saved in instrument state.
Min:	-9.9e37
Max:	9.9e37
Initial S/W Revision:	A.01060 or later
Help Map ID:	25769

Common Measurement Functions 2

Pause / Resume

Pauses or resumes acquisition at the end of the current time record acquisition.

Key Path:	Sweep Control
Mode:	VSA
Initial S/W Revision:	A.01060 or later
Help Map ID:	25857

Gate

Accesses a menu of time gating control functions. Time gating lets you isolate a portion of a Main Time record to be used for downstream spectrum and statistical analysis (instead of the whole time record). The gate position can be changed during a stopped measurement and the instantaneous gate time and spectrum traces update immediately. Averages are restarted when gate properties change. The windowing function used in gated measurements is the same as non-gated measurements.

Key Path:	Sweep Control
Mode:	VSA
Initial S/W Revision:	A.01060 or later
Help Map ID:	25858

Gate

Turns time gating on or off.

Key Path:	Sweep/Control
Mode:	VSA
Measurement:	<meas>:=VECTor ADEMod
Remote Command:	[:SENSe] :<meas>:SWEep:EGATe:STATe OFF ON 0 1 [:SENSe] :<meas>:SWEep:EGATe:STATe?
Example:	VECT:SWE:EGAT:STAT ON VECT:SWE:EGAT:STAT?
Preset:	0
State Saved:	Saved in instrument state.
Initial S/W Revision:	A.01060 or later
Help Map ID:	25721

Gate Length

Adjusts the time between the beginning and the end of the gate.

Key Path:	Sweep/Control
Mode:	VSA
Measurement:	<meas>:=VECTor ADEMod
Remote Command:	[:SENSE] :<meas>:SWEep:EGATe[:SPAN] <time> [:SENSE] :<meas>:SWEep:EGATe[:SPAN] ?
Example:	VECT:SWE:EGAT 2 MS VECT:SWE:EGAT?
Couplings:	Gate length and delay are limited so that the gate always falls within the current time record. If the time record length decreases, the gate delay is limited first, then the gate length.
Preset:	1.28125e-6
State Saved:	Saved in instrument state.
Min:	16 time samples
Max:	Time record length
Initial S/W Revision:	A.01060 or later
Help Map ID:	25722

Gate Delay

Adjusts the time between the start of the time record and the beginning of the gate.

Key Path:	Sweep/Control
Mode:	VSA
Measurement:	<meas>:=VECTor ADEMod
Remote Command:	[:SENSE] :<meas>:SWEep:EGATe:DELay <time> [:SENSE] :<meas>:SWEep:EGATe:DELay?
Example:	VECT:SWE:EGAT:DEL 500 US VECT:SWE:EGAT:DEL?
Couplings:	Gate length and delay are limited so that the gate always falls within the current time record. If the time record length decreases, the gate delay is limited first, then the gate length.
Preset:	0
State Saved:	Saved in instrument state.
Min:	0

Common Measurement Functions 2

Max:	Time record length – gate length
Initial S/W Revision:	A.01060 or later
Help Map ID:	25723

Freq Points

Enables you to manually enter the number of displayed frequency points. By default, the analyzer chooses the number of Freq Points displayed in Spectrum or PSD displays, depending on the Res BW or Main Time length chosen. Auto mode is recommended. The number of Freq Points is related to the number of FFT points used in spectrum calculations (which is always a power of 2).

$$\text{Freq Points} = (\text{FFT points})/1.28 + 1$$

Note that if All Frequency Points is turned on for a selected trace, then all computed FFT points are shown. (See “All Frequency Points” on page 1824.)

Key Path:	Sweep Control
Mode:	VSA
Measurement:	<meas>:=VECTor ADEMod
Remote Command:	[:SENSE] :<meas>:SWEep:POINts <integer> [:SENSE] :<meas>:SWEep:POINts? [:SENSE] :<meas>:SWEep:POINts:AUTO OFF ON 0 1 [:SENSE] :<meas>:SWEep:POINts:AUTO?
Example:	VECT:SWE:POIN 801 VECT:SWE:POIN? VECT:SWE:POIN:AUTO ON VECT:SWE:POIN:AUTO?
Notes:	Keyboard entry or setting this by SCPI forces state to manual. Any entry other than a valid value is rounded up to the next available value (or limited to the maximum). This key is not shown in measurements other than Vector or Analog Demod.
Couplings:	See Res BW Coupling section
Preset:	801 1
State Saved:	Saved in instrument state.
Range:	51 101 201 401 801 1601 3201 6401 12801 25601 51201 102401 204801 409601
Initial S/W Revision:	A.01060 or later
Help Map ID:	25770

Trace/Detector

Accesses a menu enabling you to select various trace parameters for all VSA based measurements.

Key Path:	Front Panel
Mode:	VSA, LTE, LTETDD, IDEN
Initial S/W Revision:	Prior to A.02.00
Modified at S/W Revision:	A.02.00
Help Map ID:	25893

Select Trace

Displays a menu that enables you to select the trace that is to receive the action of all successive trace-specific commands like scaling, assignment of trace data, and so on. The selected trace is outlined in green and is always visible. While the Select Trace menu is showing, each visible trace is annotated in the middle with its own trace number, as shown in the following figure. The trace number annotations disappear when any other menu is showing.

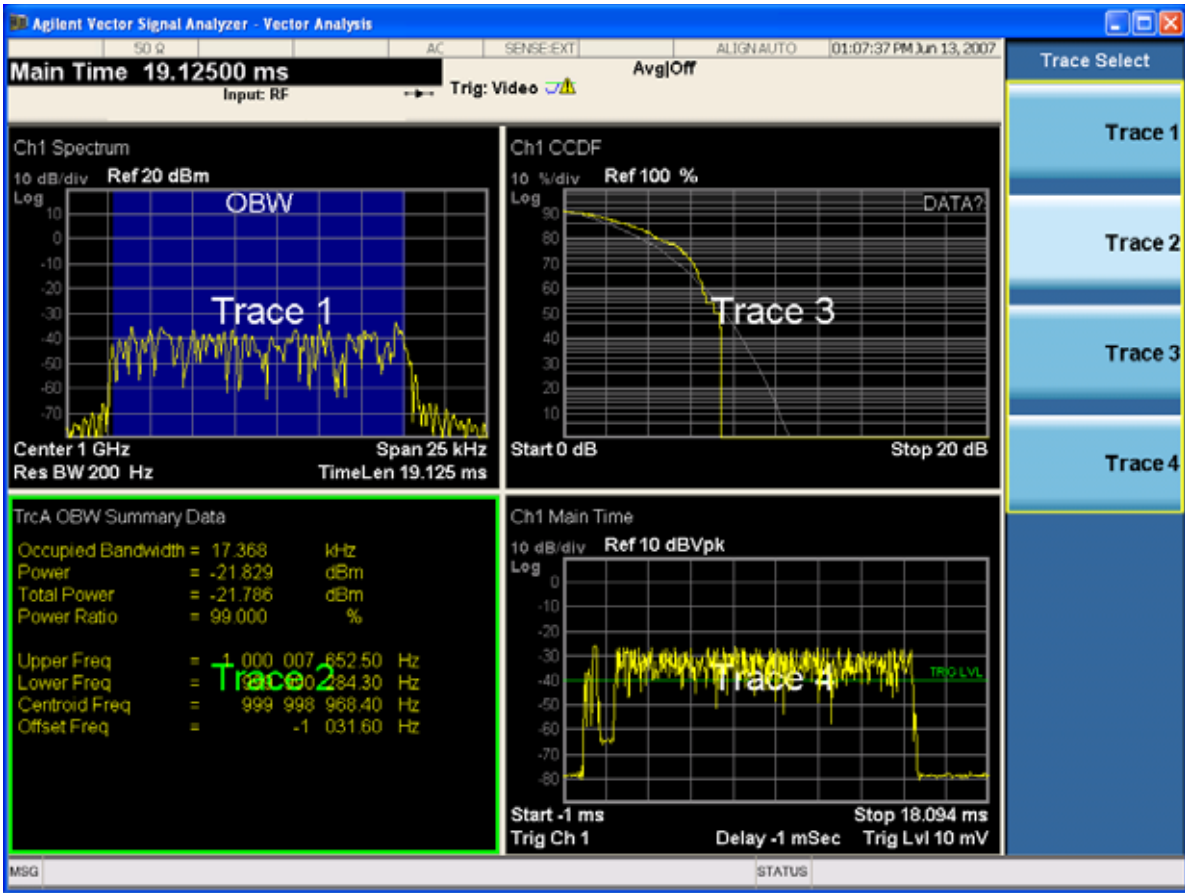

Common Measurement Functions 2

Grid 2x2 layout showing trace annotations when Trace Select dialog is active

This softkey also appears in the X and Y scaling menus. There is only one selected trace at any time. If you change which trace is selected, that change is reflected in this softkey/menu wherever it appears. Other ways to select a trace include use of the Next Window key, clicking within a trace window with a mouse cursor, and issuing a trace-specific SCPI command.

There is no SCPI command associated with this function. Instead, SCPI commands that are trace-specific have an index on the TRACe node that determines the selected trace. Using such a command has the side effect that the trace addressed by the SCPI command becomes the selected trace for any front panel interaction.

Key Path:	Trace/Detector or Span X Scale or AMPTD Y Scale
Mode:	VSA, LTE, LTETDD, IDEN
Notes:	No SCPI. Front panel only.
Couplings:	Affects any trace-specific commands
Range:	Trace 1 Trace 2 Trace 3 Trace 4 Trace 5 Trace 6
Readback Text:	Trace <n>
Initial S/W Revision:	Prior to A.02.00
Modified at S/W Revision:	A.02.00
Help Map ID:	25779

Data

Accesses a menu of Trace data choices for the selected trace. A VSA Measurement can produce many different results from a single scan; either a graph or a table. In addition, the ACP and OBW functions can be enabled on any trace, showing a frequency-domain result, and produce Summary table results. Any of these results can be assigned to a trace and displayed.

The following Trace Data types are available in all measurements:

Soft Key Name	SCPI string form
No Data	"No Data"
Spectrum	"Spectrum1"
Inst Spectrum	"Inst Spectrum1"
Raw Main Time	"Raw Main Time1"
OBW Summary for Trace 1	"Obw Summary Trc1"
OBW Summary for Trace 2	"Obw Summary Trc2"
OBW Summary for Trace 3	"Obw Summary Trc3"

OBW Summary for Trace 4	"Obw Summary Trc4"
ACP Summary for Trace 1	"Acp Summary Trc1"
ACP Summary for Trace 2	" Acp Summary Trc2"
ACP Summary for Trace 3	" Acp Summary Trc3"
ACP Summary for Trace 4	" Acp Summary Trc4"

The following Data Registers are also available for display if there are traces stored in them (see “Copy to Data Register” on page 1856:

"D1", "D2", "D3", "D4", "D5", and "D6"

Key Path:	Trace/Detector, Data
Mode:	VSA, LTE, LTETDD, IDEN
Measurement:	<meas>:=VECTor ADEMod DDEMod W11A W11B EVM IPOWER IDEMod MOTotalk
Remote Command:	:DISPlay:<meas>:TRACe [1] 2 3 4 :FEED <string> :DISPlay:<meas>:TRACe [1] 2 3 4 :FEED?
Example:	DISP:VECT:TRAC1:FEED "Spectrum1" DISP:VECT:TRAC1:FEED?
Preset:	Depends on trace number and measurement
State Saved:	Saved in instrument state.
Initial S/W Revision:	Prior to A.02.00
Modified at S/W Revision:	A.02.00
Help Map ID:	25798

The complete list of Trace Data names that can be assigned using the above SCPI can be obtained by using the following SCPI query:

Mode:	VSA, LTE, LTETDD, IDEN
Measurement:	<meas>:=VECTor ADEMod DDEMod W11A W11B EVM IPOWER IDEMod MOTotalk
Remote Command:	:CALCulate:<meas>:DATA [1] 2 3 4 :NAMEs?
Example:	CALC:VECT:DATA:NAM?
Notes:	Query only. Returns a comma-separated list of trace data names that can be used in DISPlay:<meas>:TRACe[1] 2 3 4:FEED "<string>". The list is the same regardless of trace index.
Initial S/W Revision:	Prior to A.02.00

Common Measurement Functions 2

Modified at S/W Revision:	A.02.00
Help Map ID:	0

Spectrum

Displays the Spectrum data result in the selected trace.

The Spectrum trace data displays the spectrum of the selected channel. The spectrum computation displays frequency on the x axis and amplitude on the y axis.

The following formulas show how the analyzer calculates spectrum information:

Key: F = Fast Fourier Transform (FFT)

AF = Averaged spectra

AT = Averaged time

f = Instantaneous spectra

t = Instantaneous time

W = Windowing function

n = Average number

c = Correction trace (from calibration)

$f[n]^2 = f[n] \times \text{conjugate}(f[n])$

$\times = \text{multiplication}$

No Average	$f = F(W \times t) \times c$
rms Average	$AF[n] = \frac{1}{n} \text{sum} (f [n]^2)$
rms Exponential AF[n]Average	$AF[n] = \frac{1}{n} (f [n]^2) + \frac{n-1}{n} AF[n-1]$ where $1 \leq n \leq \text{number of averages}$
Continuous Peak Hold Average	$AF[n] = \text{MAX} (AF[n-1], f [n]^2)$
Time Average	$AF[n] = F\{W \times AT[n]\} \times c$ where $AT[n] = \frac{1}{n} \text{sum} (t [n])$
Time Exponential Average	$AF[n] = F\{W \times AT[n]\} \times c$ where $AT[n] = \frac{1}{n} t [n] + \frac{n-1}{n} AT[n-1]$ and $1 \leq n \leq \text{number of averages}$

As shown in the previous formulas, the spectrum can be a linear spectrum or power spectrum as follows:

If the average is...	then the spectrum is...
----------------------	-------------------------

Averaging OFF	Linear
rms Average	Power
Continuous peak	Power

Linear spectra contain magnitude and phase (real and imaginary) information. Power spectra contain only magnitude (real) information. This occurs with rms averages, for instance, because the results of the FFT are squared. Remember that the FFT yields both real and imaginary information. When the analyzer squares the results of the FFT, the imaginary part becomes zero.

See also: [“Data” on page 1832](#)

Key Path:	Trace/Detector, Data
Mode:	VSA, LTE, LTETDD, IDEN
Initial S/W Revision:	Prior to A.02.00
Modified at S/W Revision:	A.02.00
Help Map ID:	25900

Inst Spectrum

Displays the Inst Spectrum data result in the selected trace.

Inst Spectrum trace data displays the instantaneous spectrum for the selected input channel. Instantaneous spectrum is computed before data is averaged, which enables you see spectrum data before the data is averaged with other spectrum data.

NOTE Inst Spectrum is not available when analog or digital demodulation is selected.

The following block diagram shows where spectrum and instantaneous spectrum are created.

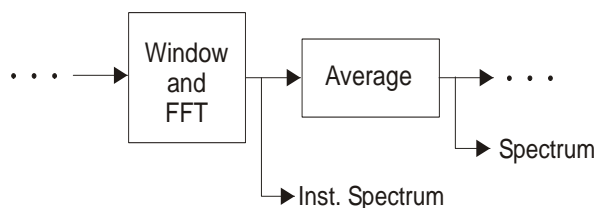

This measurement calculation is useful for these types of averaged measurements:

- rms
- rms exponential
- Continuous peak hold

If averaging is off, the spectrum and instantaneous spectrum display the same information.

Common Measurement Functions 2

See also: “Data” on page 1832

Key Path:	Trace/Detector, Data
Mode:	VSA, LTE, LTETDD, IDEN
Initial S/W Revision:	Prior to A.02.00
Modified at S/W Revision:	A.02.00
Help Map ID:	25901

Main Time

Displays the Main Time data result in the selected trace.

Main Time versus Gate Time

The term is used to differentiate between the "main" time record and the "gate" time record when time gating is on.

A time record is the basic building block of the Fast Fourier Transform (FFT). The FFT takes the time-domain information in the time record and transforms it into the frequency domain.

When time gating is on, you can identify a portion of the main time-record to be used by the FFT. The term "main time-record" identifies the entire time record; the term "gate time-record" identifies the portion selected by the gate.

The following block diagram shows the blocks that create main time and gate time.

Note that the Analog Demodulation block is available only when analog demodulation is enabled.

There are many reasons why you may want to view the main time record. Here are just a few:

- To verify that there is an input signal.
- To see the characteristics of the input signal.
- To help in manually setting the input range.

Time Records and Span

If you set the analyzer to full span, the time data you see is the actual input time-record. This is raw input data - the signal from which all subsequent measurements are based.

If you set the instrument to measure a specific bandwidth (something less than full span), the time data you see is the raw input data after it has been filtered (to provide alias protection) and decimated (to obtain the desired span).

Time Records and Averaging

If rms or continuous peak-hold averaging is on, the analyzer displays the most recent time record. The analyzer does not show an averaged time waveform, because all averaging is done after the time data has been transformed to the frequency domain.

If time averaging is on, the analyzer displays the averaged time-record. In other words, the time record has been averaged with previous time records.

How the Analyzer Displays the Time Record

It is important to remember that although the time record looks like an oscilloscope display, the analyzer is not a digital oscilloscope.

The time record represents samples of a waveform. The samples have enough information to accurately reconstruct the input signal - but the human eye may not properly perform the reconstruction. In fact, for frequencies that are higher than about ten percent of the frequency span, there is noticeable visible distortion.

The analyzer's anti-alias filters cause some ringing or distortion of square waves or transients when viewed in the time domain.

See also: [“Data” on page 1832](#)

Key Path:	Trace/Detector, Data
Mode:	VSA
Initial S/W Revision:	Prior to A.02.00
Modified at S/W Revision:	A.02.00
Help Map ID:	25902

Inst Main Time

Displays the Inst Main Time data result in the selected trace.

Inst Main Time trace data displays the instantaneous time-domain data for the selected input channel.

Note that Inst Main Time is not available when analog or digital demodulation is selected.

The following block diagram shows how Instantaneous Main Time is derived.

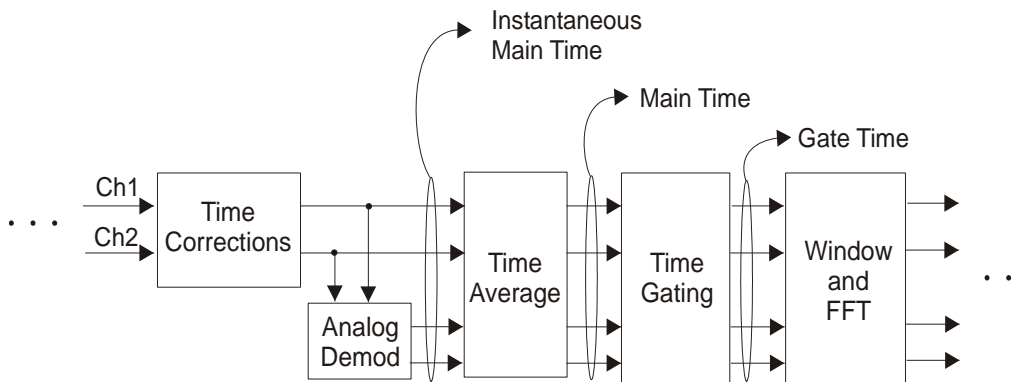

Notice that Instantaneous Main Time shows you time data before time averaging. If time averaging is off, Instantaneous Main Time is identical to Main Time.

See also: [“Data” on page 1832](#)

Key Path:	Trace/Detector, Data
Mode:	VSA, LTE, LTETDD, IDEN

Common Measurement Functions 2

Initial S/W Revision:	Prior to A.02.00
Modified at S/W Revision:	A.02.00
Help Map ID:	25903

Gate Time

Displays the Gate Time data result in the selected trace.

Gate Time trace data displays the selected channel's gate time-record.

Note that Gate Time is not available when analog or digital demodulation is selected.

If time gating is on, Gate Time displays the portion of the main time-record marked by the gate - this portion is called the gate record (if time gating is off, Gate Time displays nothing).

As a reminder, if time gating is on, the Fast Fourier Transform (FFT) uses the gate time-record, which can be all or a portion of the main time-record, to compute frequency information such as spectrum, frequency response, coherence, and correlation.

See also: [“Data” on page 1832](#)

Key Path:	Trace/Detector, Data
Mode:	VSA, LTE, LTETDD, IDEN
Initial S/W Revision:	Prior to A.02.00
Modified at S/W Revision:	A.02.00
Help Map ID:	25904

Raw Main Time

Displays the Raw Main Time data result in the selected trace.

Raw Main Time is the raw data read from the input hardware or playback file. It is similar to Main Time with the following exceptions:

- This data has not had time corrections applied, so it displays a “CAL?” trace indicator.
- The data has not gone through the analyzer's software resampling filters, so is generally not sampled at the specified sample rate.
- The data has a wider bandwidth than the measurement span would indicate.

Raw Main Time data is useful in the following situations:

- When you use Channel, IF Magnitude, or Magnitude trigger types, the input hardware detects the trigger, so Raw Main Time sometimes gives a better indication of what caused the trigger.
- When you play back a recording, the Raw Main Time measurement data enables you to see the samples that are saved in the recording, with no filtering applied or settling removed.

See also: “Data” on page 1832

Key Path:	Trace/Detector, Data
Mode:	VSA, LTE, LTETDD, IDEN
Initial S/W Revision:	Prior to A.02.00
Modified at S/W Revision:	A.02.00
Help Map ID:	25905

PSD (Power Spectral Density)

Displays the Power Spectral Density (PSD) data result in the selected trace. PSD trace data displays the power spectral density (PSD) of the selected channel. The definition of PSD yields y-axis units of V_{pk}^2/Hz and x-axis units of frequency:

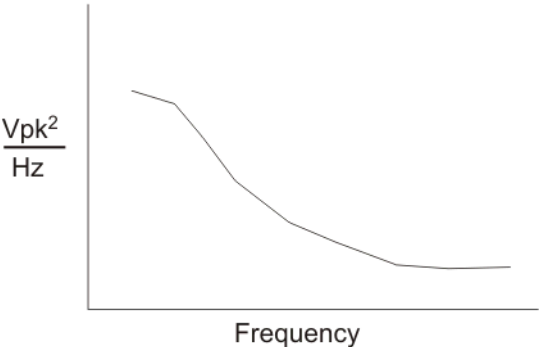

PSD is used for noise measurements. It shows the power density of a signal as a function of frequency. In general, noise can have any arbitrary frequency content, resulting in a variety of possible PSD shapes. Noise that has equal power density at all frequencies is called white noise:

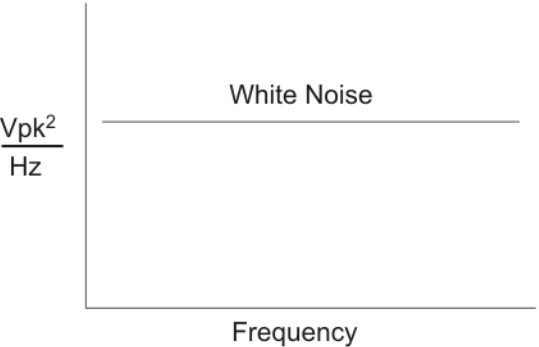

The definition of PSD is power per Hertz. In other words, power is divided by the measurement bandwidth, which in this analyzer is the resolution bandwidth (ResBW), as follows:

$$\frac{V_{pk}^2}{RBW} = \frac{V_{pk}^2}{Hz}$$

Common Measurement Functions 2

Units of V_{pk}^2/Hz assumes the signal is referenced to 1 ohm. That is, because no resistance is specified, the signal is interpreted as a voltage across a one ohm resistor with the power in the resistor equal to V_{pk}^2 .

You can select units of dBm/Hz to take into account the analyzer's input impedance. PSD defaults to these units. The analyzer calculates dBm/Hz as follows:

$$\frac{dBm}{Hz} = 10 \log \left[\frac{\frac{V_{rms}^2}{Z} \times 1000}{RBW} \right]$$

where:

RBW = resolution bandwidth (Hz)

Z = input impedance

See also: [“Data” on page 1832](#)

Key Path:	Trace/Detector, Data
Mode:	VSA, LTE, LTETDD, IDEN
Initial S/W Revision:	Prior to A.02.00
Modified at S/W Revision:	A.02.00
Help Map ID:	25906

Auto Correlation

Displays the autocorrelation data result in the selected trace. Auto Correlation trace data displays the autocorrelation for the selected input channel. Autocorrelation is a form of correlation, a measure of the similarity between two signals.

Note that Auto Correlation is not available when digital demodulation is selected.

Tips

- Use ac coupling only. Correlation measurements are disturbed by dc offsets in the signal.
- Some types of averaging can be useful - rms averaging does not affect correlation measurements, but you can use time averaging to reduce noise, if you can provide a consistent trigger. However, averaging is usually unnecessary to make good correlation measurements.
- Use appropriate triggering and trigger delays. This is especially true for time averaging.
- Use a random noise source for delay measurements. Correlation measurements provide the ability to resolve time differences between waveforms that appear to be random.
- Waveforms on the correlation trace may not appear as they do in the time trace. This is particularly noticeable when you are using correlation to extract synchronous signals from noise. The different shape of some waveforms is a direct result of the mathematical definition of correlation. For example, a correlated square wave appears as a triangle wave. It's important to remember that the period of the waveform is preserved even if the correlation waveform looks different.

- To avoid wrap-around effects, correlation produces a time record one-half the length of the measurement time-record.

Theory of Operation

Autocorrelation is a form of correlation, a measure of the similarity between two signals. Correlation is performed by multiplying two signals together at each instant in time and summing all the products. If the signals are identical, every product is positive and the resulting sum is large.

If, however, the two signals are dissimilar, then some of the products are positive and some are negative. In this case, the final sum is smaller because the products tend to cancel.

Autocorrelation performs a time-shifted, "averaged" correlation on a single signal. The signal is correlated with time-shifted versions of itself. Furthermore, the products from each time-shift are averaged by dividing each final sum by the number of products contributing to it.

$$R_{xx}(\tau) = \lim_{T \rightarrow \infty} \frac{1}{T} \int_{\text{intgrl}} [\text{conj}[x(t)] \times x(t + \tau)] dt$$

where: R_{xx} = autocorrelation function

τ = amount of time shift

= infinity

$x(\tau)$ = signal to be correlated

intgrl = integration

conj = conjugation

T = time

\times = multiplication

That is, the autocorrelation function is found by taking a signal, multiplying it by the same signal displaced (τ) units in time, and averaging the product over all time.

Duality With the Power Spectrum

For simplicity and speed, this analyzer performs the autocorrelation operation by taking advantage of its duality with the power spectrum:

$$R_{xx}(\tau) \leftrightarrow G_{xx}(f)$$

Thus,

$$\begin{aligned} R_{xx}(\tau) &= I_{\text{FFT}} [G_{xx}(f)] \\ &= I_{\text{FFT}} [\text{conj}(F[r \times t]) \times F(t)] \end{aligned}$$

where: I_{FFT} = Inverse FFT

conj = conjugation

\times = multiplication

r = half size of the rectangular window

(thus the result is $\frac{1}{2}$ the original time length)

When to use Auto Correlation

Auto correlation is useful for detecting echoes in a signal. For random noise, an echo appears as an

Common Measurement Functions 2

impulse - if there is more than one echo, you can see multiple peaks on the auto correlation trace. Keep in mind that an echo appears as an impulse only if the delayed signal has not been filtered. The impulse broadens as the original random noise signal is filtered - in fact, the width of each peak is inversely proportional to the bandwidth of the signal.

To determine the time delay (in seconds) of an echo, you can move the marker to the peak of the echo. Note that there is always a correlated peak at zero lag - this peak marks the original excitation signal. Any other peaks let you know that the excitation signal also appeared at another time relative to the original signal. The amplitude value at the zero lag point is the total power in the time record.

This function is also useful for isolating low-level periodic signals from noise. A sine wave signal shows up as a sine wave in auto correlation. A square wave signal shows up as a triangular wave of the same frequency.

Auto correlation is a single-channel measurement. If you have the original signal on one channel and the delayed version on another, use cross correlation.

Auto Correlation and Averaging

The following formulas show how the analyzer calculates auto correlation for different averaging functions:

Key: F = Fast Fourier Transform (FFT)

AC = Averaged correlation

AT = Averaged time

t = Instantaneous time

c = Instantaneous correlation

r = 1/2 width rectangular window

× = multiplication

n = Average number

No Average $c = I(\text{conj}(F(r \times t)) \times F[t])$

rms Average $c = I(\text{conj}(F(r \times t)) \times F[t])$

rms Expon. Average $c = I(\text{conj}(F(r \times t)) \times F[t])$

Continuous

Peak Hold Average $c = I(\text{conj}(F(r \times t)) \times F[t])$

Time Average $AC[n] = I(\text{conj}(F(r \times AT[n])) \times F(AT[n]))$

where: $AT[n] = \frac{1}{n} \text{sum}(t[n])$

Time

Expon. Average $AC[n] = I(\text{conj}(F(r \times AT[n])) \times F(AT[n]))$

where: $AT[n] = \frac{1}{n} t[n] + \frac{n-1}{n} AT[n-1]$

and: $1 < n < \text{number of averages}$

See also: Data

Key Path:	Trace/Detector, Data
Mode:	VSA
Initial S/W Revision:	Prior to A.02.00
Help Map ID:	25910

Statistical

Accesses the Trace Data choices that show the statistical results: CCDF, CDF and PDF.

Key Path:	Trace/Detector, Data
Mode:	VSA
Help Map ID:	30229

CCDF (Complementary, Cumulative Density Function)

Displays the CCDF data result in the selected trace. CCDF trace data displays the complementary, cumulative density function (CCDF) for the selected input channel. The complementary, cumulative density function (CCDF) is a statistical-power calculation and can be performed only on time-domain data. As its name suggests, CCDF is the complement of CDF, and is defined as follows:

$$\begin{aligned} \text{CDF}(K) &= \text{Probability}(x \leq K) \\ \text{CCDF}(K) &= \text{Probability}(x \geq K) \end{aligned}$$

CCDF provides better resolution than CDF for low probability signals, especially when log format is used for the y-axis.

The analyzer plots CCDF using units of percent (%) for the y-axis and power (dB) for the x-axis. Power on the x-axis is relative to the signal average power, so 0 dB is the average power of the signal. Therefore, a marker readout of

Trace A Marker 2 dB 12 %

means there is a 12% probability that the signal power is 2 dB or more above the average power.

CCDF Calculation:

1. Calculate the RMS value for all measured samples; this becomes the 0 dB point at the left end of the x-axis.
2. Normalize all samples to the RMS value in units of dB.
3. Determine which x-axis bin each sample belongs in between 0 and 20 dB.
4. Calculate the total number of samples that are greater than or equal to each x-axis bin and plot as a percent of the number of samples measured.

Common Measurement Functions 2

Samples Used in the Power Measurement

For the Demod Off and Analog demod modes, the analyzer computes CCDF using all samples in the current time record (all points in the active trace). Each successive time record adds additional samples to the CCDF measurement.

For WLAN - OFDM and -DSSS demod modes, the analyzer computes CCDF using all samples specified within the measurement interval.

Restarting the Power Measurement

Selecting CCDF, restarting the measurement, or changing most measurement parameters restarts the CCDF measurement. For example, changing the range or center frequency resets the number of samples used in the CCDF measurement to zero and restarts the CCDF measurement.

Tips

Note the following when making CCDF measurements:

- For best results, set the analyzer's displayed frequency span to include all the energy of your signal. In other words, make sure the displayed frequency span includes the entire bandwidth of the measured signal.
- The CCDF measurement does not restart:
 - After a calibration
 - After you continue a paused measurement
- Many channel specific changes restart the CCDF measurement on both channels, such as changing the gate delay, or input coupling.
- The analyzer displays DATA? if the average power drifts 8 to 10 dB from the average power measured in the first time record. For example, the analyzer would display DATA? if you measured a transmitter signal that was off when the CCDF measurement started but then turned on later in the measurement.
- CCDF measurements are disabled during time averaging.

See also: [“Data” on page 1832](#)

Key Path:	Trace/Detector, Data
Mode:	VSA, LTE, LTETDD, IDEN
Initial S/W Revision:	Prior to A.02.00
Modified at S/W Revision:	A.02.00
Help Map ID:	25907

CDF (Cumulative Density Function)

Displays the CDF data result in the selected trace. CDF trace data displays the Cumulative Density Function (CDF) for the selected input channel. CDF is computed by integrating the PDF (Probability Density Function).

See also: [“CCDF \(Complementary, Cumulative Density Function\)” on page 1843](#) and [“Data” on page 1832](#)

Key Path:	Trace/Detector, Data
Mode:	VSA, LTE, LTETDD, IDEN

Initial S/W Revision:	Prior to A.02.00
Modified at S/W Revision:	A.02.00
Help Map ID:	25908

PDF (Probability Density Function)

Display the PDF data result in the selected trace. PDF trace data displays the Probability Density Function of the selected channel. PDF indicates the probability that a given level has occurred.

PDF is equivalent to a normalized histogram. A histogram shows how the amplitude of a signal is distributed between its maximum and minimum values. Amplitude is displayed on the X-axis, and number of counts on the Y-axis.

The number of averages for a histogram determines the number of counts in the histogram; in other words, how many records are measured - the records are not "averaged". If averaging is off or if exponential averaging is selected, the measurement continues indefinitely. Keep in mind that the accuracy of the histogram is dependent on the frequency span, time-record length, and number of averages (if averaging is on).

Histograms are used for such things as determining the statistical properties of noise and monitoring the performance of electromechanical positioning systems.

PDF trace data is normalized by multiplying the number of averages by the number of points in the time record, then dividing this value by the DV spacing on the X-axis. The probability of a signal falling between two points is equal to the integral of the curve between those points.

PDF trace data displays the number of points used in its computation above the trace (Pts:). It also displays the average level (Avg:) above the trace.

See also: ["Data" on page 1832](#)

Key Path:	Trace/Detector, Data
Mode:	VSA, LTE, LTETDD, IDEN
Initial S/W Revision:	Prior to A.02.00
Modified at S/W Revision:	A.02.00
Help Map ID:	25909

ACP (Adjacent Channel Power)

Provides access to ACP summary table data. These results are available when the ACP function is enabled for a particular trace, and it enables you to display the results in another trace.

Key Path:	Trace/Detector, Data
Mode:	VSA, LTE, LTETDD, IDEN
Initial S/W Revision:	Prior to A.02.00
Modified at S/W Revision:	A.02.00
Help Map ID:	30234

Common Measurement Functions 2

ACP Summary for Trace 1

Displays results for the ACP function on Trace 1 in the selected trace.

See also: [“ACP Setup” on page 1860](#)

Key Path:	Trace/Detector, Data, ACP
Mode:	VSA, LTE, LTETDD, IDEN
Initial S/W Revision:	Prior to A.02.00
Modified at S/W Revision:	A.02.00
Help Map ID:	25911

ACP Summary for Trace 2

Displays results for the ACP function on Trace 2 in the selected trace.

See also: [“ACP Setup” on page 1860](#)

Key Path:	Trace/Detector, Data, ACP
Mode:	VSA, LTE, LTETDD, IDEN
Initial S/W Revision:	Prior to A.02.00
Modified at S/W Revision:	A.02.00
Help Map ID:	25912

ACP Summary for Trace 3

Displays results for the ACP function on Trace 3 in the selected trace.

See also: [“ACP Setup” on page 1860](#)

Key Path:	Trace/Detector, Data, ACP
Mode:	VSA, LTE, LTETDD, IDEN
Initial S/W Revision:	Prior to A.02.00
Modified at S/W Revision:	A.02.00
Help Map ID:	25913

ACP Summary for Trace 4

Displays results for the ACP function on Trace 4 in the selected trace.

See also: [“ACP Setup” on page 1860](#)

Key Path:	Trace/Detector, Data, ACP
Mode:	VSA, LTE, LTETDD, IDEN
Initial S/W Revision:	Prior to A.02.00

Modified at S/W Revision:	A.02.00
Help Map ID:	25914

ACP Summary for Trace 5

Displays results for the ACP function on Trace 5 in the selected trace.

See also: [“ACP Setup” on page 1860](#)

Key Path:	Trace/Detector, Data, ACP
Mode:	VSA
Help Map ID:	25915

ACP Summary for Trace 6

Displays results for the ACP function on Trace 6 in the selected trace.

See also: [“ACP Setup” on page 1860](#)

Key Path:	Trace/Detector, Data, ACP
Mode:	VSA
Help Map ID:	25916

OBW (Occupied Bandwidth)

Provides access to OBW summary table data. These results are available if the OBW function is enabled for a particular trace, and enable you to display the results in another trace.

Key Path:	Trace/Detector, Data
Mode:	VSA, LTE, LTETDD, IDEN
Initial S/W Revision:	Prior to A.02.00
Modified at S/W Revision:	A.02.00
Help Map ID:	30235

OBW Summary for Trace 1

Displays results for the OBW function on Trace 1 in the selected trace.

See also: [“OBW Setup \(Occupied Bandwidth\)” on page 1868](#)

Key Path:	Trace/Detector, Data, OBW
Mode:	VSA, LTE, LTETDD, IDEN
Initial S/W Revision:	Prior to A.02.00
Modified at S/W Revision:	A.02.00

Common Measurement Functions 2

Help Map ID:	25917
--------------	-------

OBW Summary for Trace 2

Displays results for the OBW function on Trace 2 in the selected trace.

See also: [“OBW Setup \(Occupied Bandwidth\)” on page 1868](#)

Key Path:	Trace/Detector, Data, OBW
Mode:	VSA, LTE, LTETDD, IDEN
Initial S/W Revision:	Prior to A.02.00
Modified at S/W Revision:	A.02.00
Help Map ID:	25918

OBW Summary for Trace 3

Displays results for the OBW function on Trace 3 in the selected trace.

See also: [“OBW Setup \(Occupied Bandwidth\)” on page 1868](#)

Key Path:	Trace/Detector, Data, OBW
Mode:	VSA, LTE, LTETDD, IDEN
Initial S/W Revision:	Prior to A.02.00
Modified at S/W Revision:	A.02.00
Help Map ID:	25919

OBW Summary for Trace 4

Displays results for the OBW function on Trace 4 in the selected trace.

See also: [“OBW Setup \(Occupied Bandwidth\)” on page 1868](#)

Key Path:	Trace/Detector, Data, OBW
Mode:	VSA, LTE, LTETDD, IDEN
Initial S/W Revision:	Prior to A.02.00
Modified at S/W Revision:	A.02.00
Help Map ID:	25920

OBW Summary for Trace 5

Displays results for the OBW function on Trace 5 in the selected trace.

See also: [“OBW Setup \(Occupied Bandwidth\)” on page 1868](#)

Key Path:	Trace/Detector, Data, OBW
-----------	----------------------------------

Mode:	VSA
Help Map ID:	25921

OBW Summary for Trace 6

Displays results for the OBW function on Trace 6 in the selected trace.

See also: [“OBW Setup \(Occupied Bandwidth\)” on page 1868](#)

Key Path:	Trace/Detector, Data, OBW
Mode:	VSA
Help Map ID:	25922

No Data

Enables you to turn off trace computations. Measurement results are not computed unless assigned to a trace. No Data lets you increase measurement speed by turning off post-processing calculations that are not needed.

Key Path:	Trace/Detector, Data
Mode:	VSA, LTE, LTETDD, IDEN
Initial S/W Revision:	Prior to A.02.00
Modified at S/W Revision:	A.02.00
Help Map ID:	30236

Format

Accesses a menu that enables you to choose the format of the selected trace. Any format can be assigned to any trace. For symbol tables and tabular data the format choice is ignored. If the data doesn't have defined symbol times, Constellation format is the same as I-Q, Eye formats are the same as Real or Imaginary, and Trellis format is the same as Unwrapped Phase.

The formats are:

Format name	Description
Log Mag (dB)	Data is converted to decibel units and shown on a linear Y axis
Linear Mag (Abs Value)	Magnitude of the data is shown on a linear Y axis
Real (I)	Real part of data is shown on a linear Y axis
Imaginary (Q)	Imaginary part of data is shown on linear Y axis
I-Q	Real part of data is shown on horizontal axis, imaginary part is shown on vertical axis, Independent variable (X axis) is normal to display
Constellation	Same as I-Q, but for data with symbols defined, only the symbol points are shown as dots with no connecting lines.

Common Measurement Functions 2

Wrap Phase	Phase of complex data, limited to ± 180 deg, is shown on Y axis
Unwrap Phase	Phase of complex data is shown "unwrapped", that is, without discontinuities. Not limited to ± 180 degrees.
I-Eye	Real part of data is shown with X axis segmented (generally into 2 symbol segments) and each segment is overlaid to show signal crossings at symbol boundaries
Q-Eye	Same as I-eye but imaginary part of data is shown
Trellis	Same as I-eye but uses unwrapped phase of data
Group Delay	Useful for frequency response displays. Shows the derivative of phase response with respect to frequency.
Log Mag (Linear Unit)	Displays data with a logarithmic Y axis, but marker read outs are in linear magnitude units.

Key Path:	Trace/Detector, Format
Mode:	VSA, LTE, LTETDD, IDEN
Measurement:	<meas>:=VECTor ADEMod DDEMod W11A W11B EVM IPOWer IDEMod MOTotalk
Remote Command:	:DISPlay:<meas>:TRACe [1] 2 3 4:FORMat MLOG MLINear REAL IMAGinary VECTor CONS PHASe UPHase IE YE QEYE TRELlis GDElay MLGLinear :DISPlay:<meas>:TRACe [1] 2 3 4:FORMat?
Example:	DISP:DDEM:TRAC2:FORM MLIN DISP:DDEM:TRAC2:FORM?
Preset:	Depends on trace and measurement
State Saved:	Saved in instrument state.
Range:	Log Mag (dB) Linear Mag (Abs Value) Real (I) (Lin) Imaginary (Q) (Lin) I-Q Constellation Wrap Phase Unwrap Phase I-Eye Q-Eye Trellis-Eye Group Delay Log Mag (Linear Unit)
Readback Text:	Log Mag (dB) Linear Mag Real (I) Imaginary (Q) I-Q Constellation Wrap Phase Unwrap Phase I-Eye Q-Eye Trellis-Eye Group Delay Log Mag
Initial S/W Revision:	Prior to A.02.00
Modified at S/W Revision:	A.02.00
Help Map ID:	25713

Digital Demod Trace Setup

Accesses a menu of settings that control certain elements of displays of digitally demodulated trace data.

Key Path:	Trace/Detector
-----------	-----------------------

Mode:	VSA, LTE, LTETDD, IDEN
Initial S/W Revision:	Prior to A.02.00
Modified at S/W Revision:	A.02.00
Help Map ID:	25894

Symbol Shape

Enables you to display dots, bars, or nothing (none) at symbol locations (if the trace contains demodulated time-domain data) for all time-domain displays except IQ diagrams. This key enables you to select the symbol shape for the selected trace.

If you select bars, vertical lines (bars) are drawn from the baseline to the symbol location on the trace. The baseline is 0 for all traces that have coordinates other than log (dB). The baseline is the bottom of the trace box for traces that have log (dB) coordinates.

With IQ diagrams, displaying vertical bars is meaningless. Therefore, selecting bars displays dots in IQ diagrams.

With constellation diagrams, selecting none is the same as selecting bars - you cannot turn off the dots in a constellation diagram.

Key Path:	Trace/Detector, Digital Demod Trace Setup
Mode:	VSA, LTE, LTETDD, IDEN
Measurement:	<meas>:=VECTor ADEMod DDEMod W11A W11B EVM IPOWer IDEMod MOTotalk
Remote Command:	:DISPlay:<meas>:TRACe [1] 2 3 4 :DDEMod:SYMBol BARS DOTS OFF :DISPlay:<meas>:TRACe [1] 2 3 4 :DDEMod:SYMBol?
Example:	DISP:DDEM:TRAC2:DDEM:SYMB DOTS DISP:DDEM:TRAC2:DDEM:SYMB?
Preset:	BARS
State Saved:	Saved in instrument state.
Range:	Bars Dots None
Initial S/W Revision:	Prior to A.02.00
Modified at S/W Revision:	A.02.00
Help Map ID:	25800

Ideal State Shape

Enables you to choose between a cross, circle, or none to represent the ideal state on the selected trace. Digital Demodulation shows you the location of all ideal symbol states in an I-Q or constellation

Common Measurement Functions 2

diagram.

Key Path:	Trace/Detector, Digital Demod Trace Setup
Mode:	VSA, LTE, LTETDD, IDEN
Measurement:	<meas>:=VECTor ADEMod DDEMod W11A W11B EVM IPOWer IDEMod MOTotalk
Remote Command:	:DISPlay:<meas>:TRACe [1] 2 3 4 :DDEMod:SYMBol:SHAPE CIRCle CROSS OFF :DISPlay:<meas>:TRACe [1] 2 3 4 :DDEMod:SYMBol:SHAPE?
Example:	DISP:DDEM:TRAC2:DDEM:SYMB:SHAP CIRC DISP:DDEM:TRAC2:DDEM:SYMB:SHAP?
Preset:	CIRC
State Saved:	Saved in instrument state.
Range:	Circle Cross None
Initial S/W Revision:	Prior to A.02.00
Modified at S/W Revision:	A.02.00
Help Map ID:	25801

Ideal State Size

Determines the ideal state size, as a percentage of the maximum ideal state distance from the origin (the same way Error Vector Magnitude is defined). Ideal states are shown as circles or crosses in Vector and constellation diagrams, as determined by the Ideal State Shape setting.

The ideal state is where symbols occur if your signal is without error. Showing the ideal states gives a visual indication of the quality of your signal.

You can use this feature to determine if symbols have an EVM above a specified Value. For example, to see if any symbols have an EVM greater than 10%, set the state size to 10% and select Circle as the shape. Any symbols that fall outside of the circle (other than SYNC or PILOT symbols) have an EVM greater than 10%.

Key Path:	Trace/Detector, Digital Demod Trace Setup
Mode:	VSA, LTE, LTETDD, IDEN
Measurement:	<meas>:=VECTor ADEMod DDEMod W11A W11B EVM IPOWer IDEMod MOTotalk
Remote Command:	:DISPlay:<meas>:TRACe [1] 2 3 4 :DDEMod:SYMBol:SIZE <real> :DISPlay:<meas>:TRACe [1] 2 3 4 :DDEMod:SYMBol:SIZE?
Example:	DISP:DDEM:TRAC2:DDEM:SYMB:SIZE 10 DISP:DDEM:TRAC2:DDEM:SYMB:SIZE?

Notes:	Parameter is interpreted as a percent, e.g., if you want the ideal size to be 10% send 10, not 0.1
Preset:	5
State Saved:	Saved in instrument state.
Min:	0.1
Max:	50
Initial S/W Revision:	Prior to A.02.00
Modified at S/W Revision:	A.02.00
Help Map ID:	25802

Symbol Table Format

Enables you to choose the format in which symbol table data is displayed, when the modulation format encodes 4 or more bits per symbol. You can choose binary or hexadecimal. Binary symbol data is padded with leading zeros to make a multiple of 4 bits before conversion to hexadecimal. For example, for 16 QAM format, each 4-bit symbol is displayed as 2 hex digits.

Binary Format: The symbol data bit format is binary and each character represents a binary digit. The number to the left of each row indicates the bit offset of the first bit in the row.

Hexadecimal Format: The symbol data bit format is hexadecimal and each character represents a hexadecimal digit. The number to the left of each row indicate the symbol offset of the first symbol in the row.

NOTE There must be at least 4 bits/symbol to use the hexadecimal format, that is, symbols that have less than 4 bits/symbol are only displayed in binary format regardless of the Symbol Table Format setting.

This parameter is valid only when:

- The active trace is a symbol table, and
- The current demodulation format supports hexadecimal, the demodulation format's bits/symbol is equal to or greater than four.

Key Path:	Trace/Detector, Digital Demod Trace Setup
Mode:	VSA, LTE, LTETDD, IDEN
Measurement:	<meas>:=VECTor ADEMod DDEMod W11A W11B EVM IPOWER IDEMod MOTotalk
Remote Command:	:DISPlay:<meas>:TRACe [1] 2 3 4 :DDEMod:SYMBOL:FORMat HEXadecimal BINary :DISPlay:<meas>:TRACe [1] 2 3 4 :DDEMod:SYMBOL:FORMat?

Common Measurement Functions 2

Example:	DISP:DDEM:TRAC2:DDEM:SYMB:FORM BIN DISP:DDEM:TRAC2:DDEM:SYMB:FORM?
Preset:	HEX
Range:	Hex Binary
Initial S/W Revision:	Prior to A.02.00
Modified at S/W Revision:	A.02.00
Help Map ID:	25803

Eye Length

Controls how wide (in symbol periods) the eye and trellis diagrams are, for the selected trace.

Key Path:	Trace/Detector, Digital Demod Trace Setup
Mode:	VSA, LTE, LTETDD, IDEN
Measurement:	<meas>:=VECTor ADEMod DDEMod W11A W11B EVM IPOWer IDEMod MOTotalk
Remote Command:	:DISPlay:<meas>:TRACe [1] 2 3 4 :DDEMod:EYE:COUNT <real> :DISPlay:<meas>:TRACe [1] 2 3 4 :DDEMod:EYE:COUNT?
Example:	DISP:DDEM:TRAC2:DDEM:EYE:COUN 3 DISP:DDEM:TRAC2:DDEM:EYE:COUN?
Preset:	2
State Saved:	Saved in instrument state.
Min:	0.1
Max:	40
Initial S/W Revision:	Prior to A.02.00
Modified at S/W Revision:	A.02.00
Help Map ID:	25804

Time Unit

Enables you to select the time units that are applied to x-axis annotations and marker readouts for the selected trace, whenever it is assigned data with (demodulation) symbol information. The available measurement units are sym (symbols) or sec (seconds).

Key Path:	Trace/Detector, Digital Demod Trace Setup
Mode:	VSA, LTE, LTETDD, IDEN
Measurement:	<meas>:=VECTor ADEMod DDEMod W11A W11B EVM IPOWer IDEMod MOTotalk

Remote Command:	:DISPlay:<meas>:TRACe [1] 2 3 4 :DDEMod:UNIT:TIME SEC SYMBOL :DISPlay:<meas>:TRACe [1] 2 3 4 :DDEMod:UNIT:TIME?
Example:	DISP:VECT:TRAC2:DDEM:UNIT:TIME SYMB DISP:VECT:TRAC2:DDEM:UNIT:TIME?
Preset:	SYMB
State Saved:	Saved in instrument state.
Range:	sym sec
Initial S/W Revision:	Prior to A.02.00
Modified at S/W Revision:	A.02.00
Help Map ID:	25805

Freq Unit

Enables you to select the frequency units that are applied to x-axis annotations and marker readouts for the selected trace, whenever it is assigned data with (demodulation) carrier information. The available measurement units are carrier or Hz.

Key Path:	Trace/Detector, Digital Demod Trace Setup
Mode:	VSA, LTE, LTETDD, IDEN
Measurement:	<meas>:=VECTor ADEMod DDEMod W11A W11B EVM IPOWER IDEMod MOTotalk
Remote Command:	:DISPlay:<meas>:TRACe [1] 2 3 4 :DDEMod:UNIT:FREQuency CARRier HZ :DISPlay:<meas>:TRACe [1] 2 3 4 :DDEMod:UNIT:FREQuency?
Example:	DISP:VECT:TRAC2:DDEM:UNIT:FREQ CARR DISP:VECT:TRAC2:DDEM:UNIT:FREQ?
Preset:	CARR
State Saved:	Saved in instrument state.
Range:	carrier Hz
Initial S/W Revision:	Prior to A.02.00
Modified at S/W Revision:	A.02.00
Help Map ID:	25714

Avg Line

Controls whether or not the average line is visible on certain demodulation analysis traces such as Error Vector Time and Error Vector Spectrum in OFDM related modulation analysis measurements. These traces have 2-dimensional domains; typically subcarriers (frequency) and symbol times. Since the result

Common Measurement Functions 2

can only be shown with one of these dimensions on the x-axis, the other dimension is placed on the z-axis. Since all the z-axis values are overlapped, an average is calculated for all z values at each x value and the average is normally displayed as a line in front of trace. The average line display can be turned on or off using this control.

Key Path:	Trace/Detector, Digital Demod Trace Setup
Mode:	VSA, LTE, LTETDD, IDEN
Measurement:	<meas>:=VECTor ADEMod DDEMod W11A W11B EVM IPOWer IDEMod MOTotalk
Remote Command:	:DISPlay:<meas>:TRACe [1] 2 3 4 :DDEMod:ALINe OFF ON 0 1 :DISPlay:<meas>:TRACe [1] 2 3 4 :DDEMod:ALIN?
Example:	DISP:W11A:TRAC:DDEM:ALIN OFF
Preset:	1
State Saved:	Saved in instrument state.
Initial S/W Revision:	A.03.00 or later
Help Map ID:	30226

Copy to Data Register

Accesses a menu of immediate execute keys, each of which copies the selected trace to a particular data register. Data registers can be displayed in any trace. They are measurement global, so you can copy data to a register while in the Digital Demod measurement and view it later while in the Vector measurement. Data registers are cleared when the VSA Application is exited and reentered, but not when you change Modes and return.

Key Path:	Trace/Detector
Mode:	VSA, LTE, LTETDD, IDEN
Measurement:	<meas>:=VECTor ADEMod DDEMod W11A W11B EVM IPOWer IDEMod MOTotalk
Remote Command:	:DISPlay:<meas>:TRACe [1] 2 3 4 :COPY D1 D2 D3 D4 D5 D6
Example:	DISP:VECT:TRAC:COPY D1
Readback Text:	Last: <date_time> Empty
Initial S/W Revision:	Prior to A.02.00
Modified at S/W Revision:	A.02.00
Help Map ID:	25806

The following SCPI provides means to determine if a Data Register is empty, and to erase the data from

any or all Data Registers.

Mode:	VSA, LTE, LTETDD, IDEN
Remote Command:	:CALCulate:DATA:REGister [1] 2 3 4 5 6 :EMPTy?
Example:	:CALC:DATA:REG2:EMPT?
Notes:	Query only: returns 1 if a Data Register has no trace data assigned to it.
Initial S/W Revision:	Prior to A.02.00
Modified at S/W Revision:	A.02.00
Help Map ID:	0

Mode:	VSA, LTE, LTETDD, IDEN
Remote Command:	:CALCulate:DATA:REGister [1] 2 3 4 5 6 :REMOve
Example:	:CALC:DATA:REG2:REM
Notes:	Removes trace data assigned to specified Data Register.
Couplings:	If Data Register is assigned to a trace, the trace data is changed to No Data
Initial S/W Revision:	Prior to A.02.00
Modified at S/W Revision:	A.02.00
Help Map ID:	0

Mode:	VSA, LTE, LTETDD, IDEN
Remote Command:	:CALCulate:DATA:REGister:ALL:REMOve
Example:	:CALC:DATA:REG:ALL:REM
Notes:	Removes trace data assigned to all Data Registers.
Couplings:	If Data Register is assigned to a trace, the trace data is changed to No Data
Initial S/W Revision:	Prior to A.02.00
Modified at S/W Revision:	A.02.00
Help Map ID:	0

Phase/Delay Properties

Accesses a menu of properties that affect the selected trace when displayed using phase or delay formats.

Key Path:	Trace/Detector
Mode:	VSA, LTE, LTETDD, IDEN
Initial S/W Revision:	Prior to A.02.00

Common Measurement Functions 2

Modified at S/W Revision:	A.02.00
Help Map ID:	25895

Phase/Trellis Offset

Only used if the trace format is Wrap Phase, Unwrap Phase, or Trellis. For Unwrap Phase or Trellis traces, the phase offset value is added to the existing phase at each point. For example, if you are viewing an Unwrapped Phase trace, setting the Phase/Trellis Offset to 5 degrees moves the entire trace up 5 degrees (and changes the value displayed by a marker by the same amount). For Wrap Phase traces the phase offset only affects the phase wrap point, not the underlying data. The point at which the phase wraps is 180 degrees plus the phase offset. For example, suppose you have a marker on a Wrap Phase trace whose phase offset is 0 and the marker is showing -3 degrees. The trace data is all confined within (-180, 180] degrees. If you then change the phase offset to 180 degrees, then the Wrap Phase trace shows values within the interval (0, 360] degrees and the marker value is displayed as 357 degrees, which is the wrapped equivalent of -3 degrees.

Key Path:	Trace/Detector, Phase Delay Properties
Mode:	VSA, LTE, LTETDD, IDEN
Measurement:	<meas>:=VECTor ADEMod DDEMod W11A W11B EVM IPOWer IDEMod MOTotalk
Remote Command:	:DISPlay:<meas>:TRACe [1] 2 3 4 : FORMat : PHASe : OFFSet <real> :DISPlay:<meas>:TRACe [1] 2 3 4 : FORMat : PHASe : OFFSet?
Example:	DISP:DDEM:TRAC3:FORM:PHAS:OFFS 31 DISP:DDEM:TRAC3:FORM:PHAS:OFFS?
Preset:	0
State Saved:	Saved in instrument state.
Min:	-1E+8
Max:	1E+8
Initial S/W Revision:	Prior to A.02.00
Modified at S/W Revision:	A.02.00
Help Map ID:	25810

Unwrap Phase Ref

Enables you to designate the point (x-axis) value about which phase values are to be unwrapped. That is, the phase at the designated reference is within -180 to 180 degrees, and phase varies smoothly without jumps around that point.

Key Path:	Trace/Detector, Phase Delay Properties
Mode:	VSA, LTE, LTETDD, IDEN

Measurement:	<meas>:=VECTor ADEMod DDEMod W11A W11B EVM IPOWER IDEMod MOTotalk
Remote Command:	:DISPlay:<meas>:TRACe [1] 2 3 4 : FORMat : PHASe : UNWRap : REFe rence <real> :DISPlay:<meas>:TRACe [1] 2 3 4 : FORMat : PHASe : UNWRap : REFe rence?
Example:	DISP:DDEM:TRAC3:FORM:PHAS:UNWR:REF 24.5E6 DISP:DDEM:TRAC3:FORM:PHAS:UNWR:REF?
Preset:	0
State Saved:	Saved in instrument state.
Min:	-9.9e37
Max:	9.9e37
Initial S/W Revision:	Prior to A.02.00
Modified at S/W Revision:	A.02.00
Help Map ID:	25811

Group Delay Aperture

Used when the trace format is Group Delay. The aperture is specified as a percentage of the current frequency span for frequency-domain data. It is specified as a percentage of the time-record length for time-domain data.

When group delay is calculated for a given point (which can be a time- or frequency-domain point), the aperture is centered at that point. Larger apertures decrease resolution, but they increase the smoothing of the group-delay trace.

The point plotted for group delay is located between the data points used to calculate it. For example, in the frequency domain, the group delay for 100 Hz can be calculated by measuring the change in phase between 90 and 110 Hz. If you had specified a start frequency of 90 Hz, 100 Hz would be the first point with group delay data. This results in a trace that does not extend to the edges of the screen (more noticeable as the delay aperture increases).

Note that the smallest aperture that you can select depends on the number of frequency points. If you select an invalid aperture, the analyzer automatically selects the smallest valid aperture.

Key Path:	Trace/Detector, Phase Delay Properties
Mode:	VSA, LTE, LTETDD, IDEN
Measurement:	<meas>:=VECTor ADEMod DDEMod W11A W11B EVM IPOWER IDEMod MOTotalk
Remote Command:	:DISPlay:<meas>:TRACe [1] 2 3 4 : FORMat : DELay : APERture <real> :DISPlay:<meas>:TRACe [1] 2 3 4 : FORMat : DELay : APERture?

Common Measurement Functions 2

Example:	DISP:DDEM:TRAC3:FORM:DEL:APER 1 DISP:DDEM:TRAC3:FORM:DEL:APER?
Notes:	Parameter is interpreted as a percent, e.g., if you want the group delay aperture to be 1% send 1, not 0.01
Preset:	0.5
State Saved:	Saved in instrument state.
Min:	0.00390625
Max:	16
Initial S/W Revision:	Prior to A.02.00
Modified at S/W Revision:	A.02.00
Help Map ID:	25812

ACP Setup

Accesses a menu of functions that enable you to define and turn on the ACP function on the selected trace. One reference channel and up to 5 offset frequencies can be defined, and ACP is calculated for bands both above and below the reference frequency for each offset.

The adjacent channel power (ACP) function calculates the power in a reference band of frequencies as well as bands of frequencies offset from the reference, and calculates the ratio of each offset band to the reference band power.

An ACP measurement can be defined for each trace, although it is only active on frequency-domain trace data. The reference and offset frequency bands defined by the ACP measurement are shown as gold bars overlaying the trace display. To see tabular data showing power and power ratio results, you can assign the ACP Summary (Trace n) to a different trace. For example, you can assign Spectrum data to trace 1, turn on and define an ACP measurement on trace 1, assign the ACP Summary (Trace 1) to trace 2, and use a 2x2 display to view both at the same time, as shown below.

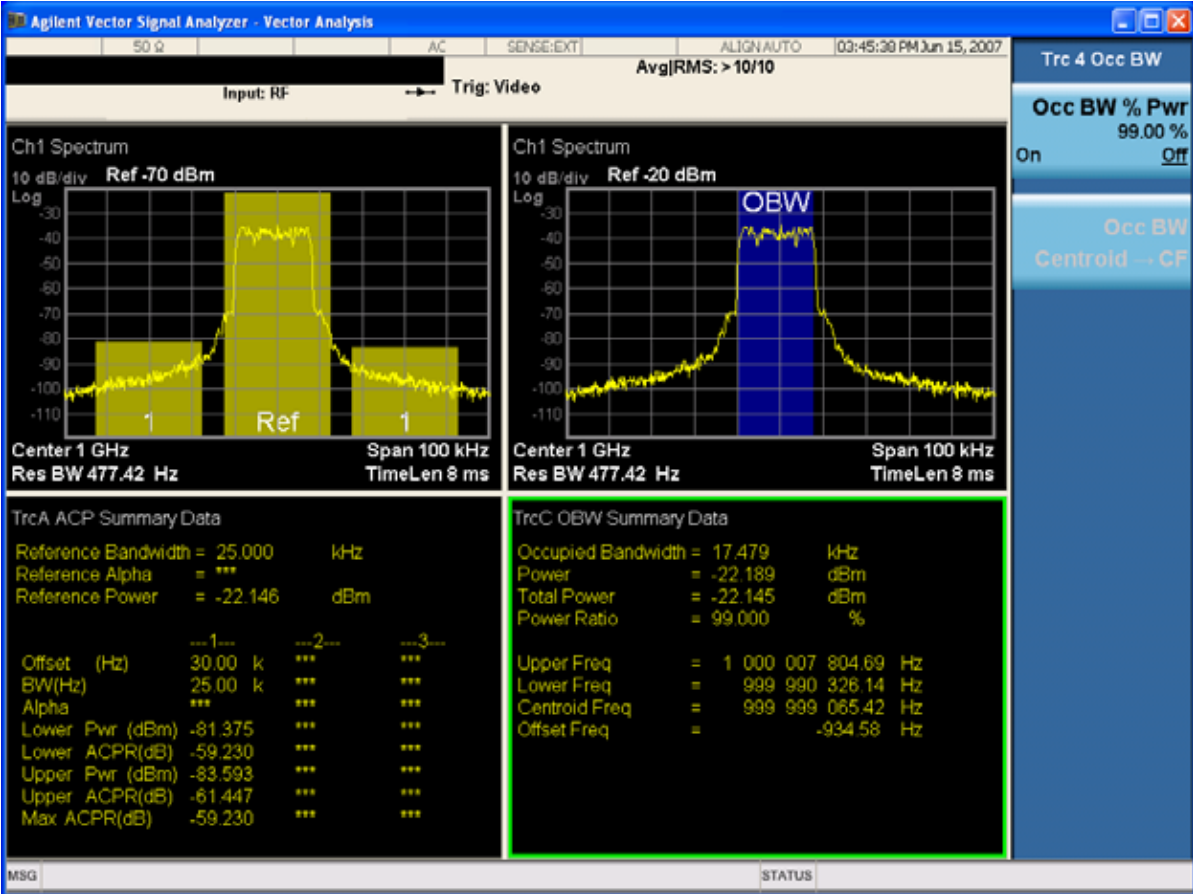

The summary data can be retrieved programmatically using FETCh? or the CALCulate:<meas>:DATA:TABLE commands. See “:CALCulate:DATA:TABL commands” on page 1902 for more details.

Key Path:	Trace/Detector
Mode:	VSA, LTE, LTETDD, IDEN
Readback Text:	[On Off,]
Initial S/W Revision:	Prior to A.02.00
Modified at S/W Revision:	A.02.00
Help Map ID:	25813

ACP On/Off

Turns the ACP function on or off for the selected trace.

Key Path:	Trace/Detector, ACP
-----------	---------------------

Common Measurement Functions 2

Mode:	VSA, LTE, LTETDD, IDEN
Measurement:	<meas>:=VECTor ADEMod DDEMod W11A W11B EVM IPOWer IDEMod MOTotalk
Remote Command:	:CALCulate:<meas>:TRACe [1] 2 3 4 :ACPoweR:STATe OFF ON 0 1 :CALCulate:<meas>:TRACe [1] 2 3 4 :ACPoweR:STATe?
Example:	CALC:VECT:TRAC1:ACP:STATE ON CALC:VECT:TRAC1:ACP:STATE?
Preset:	0
State Saved:	Saved in instrument state.
Initial S/W Revision:	Prior to A.02.00
Modified at S/W Revision:	A.02.00
Help Map ID:	25814

Carrier Freq

Enables you to enter the carrier frequency of the reference channel for the ACP measurement. The carrier frequency is relative to the center frequency of the measurement. There is only one available reference carrier.

Key Path:	Trace/Detector, ACP
Mode:	VSA, LTE, LTETDD, IDEN
Measurement:	<meas>:=VECTor ADEMod DDEMod W11A W11B EVM IPOWer IDEMod MOTotalk
Remote Command:	:CALCulate:<meas>:TRACe [1] 2 3 4 :ACPoweR:CARRier:FREQue ncy <freq> :CALCulate:<meas>:TRACe [1] 2 3 4 :ACPoweR:CARRier:FREQue ncy?
Example:	CALC:VECT:TRAC1:ACP:CARR:FREQ 100 KHZ CALC:VECT:TRAC1:ACP:CARR:FREQ?
Preset:	0
State Saved:	Saved in instrument state.
Min:	-9.9e37
Max:	9.9e37
Initial S/W Revision:	Prior to A.02.00
Modified at S/W Revision:	A.02.00
Help Map ID:	25815

Carrier Meas Noise BW

Enables you to define the measurement noise bandwidth of the reference channel.

Key Path:	Trace/Detector, ACP
Mode:	VSA, LTE, LTETDD, IDEN
Measurement:	<meas>:=VECTor ADEMod DDEMod W11A W11B EVM IPOWER IDEMod MOTotalk
Remote Command:	:CALCulate:<meas>:TRACe [1] 2 3 4 :ACPpower:CARRier: BANDwi dth BWIDth: INTEgration <bandwidth> :CALCulate:<meas>:TRACe [1] 2 3 4 :ACPpower:CARRier: BANDwi dth BWIDth: INTEgration?
Example:	CALC:VECT:TRAC1:ACP:CARR:BAND:INT 1 MHZ CALC:VECT:TRAC1:ACP:CARR:BAND:INT?
Preset:	1000000
State Saved:	Saved in instrument state.
Min:	-9.9e37
Max:	9.9e37
Initial S/W Revision:	Prior to A.02.00
Modified at S/W Revision:	A.02.00
Help Map ID:	25816

Carrier RRC Weighting

Turns on or off RRC weighting for the reference (carrier) power measurement.

Key Path:	Trace/Detector, ACP
Mode:	VSA, LTE, LTETDD, IDEN
Measurement:	<meas>:=VECTor ADEMod DDEMod W11A W11B EVM IPOWER IDEMod MOTotalk
Remote Command:	:CALCulate:<meas>:TRACe [1] 2 3 4 :ACPpower:CARRier: FILTer :RRC:STATE OFF ON 0 1 :CALCulate:<meas>:TRACe [1] 2 3 4 :ACPpower:CARRier: FILTer :RRC:STATE?
Example:	CALC:VECT:TRAC1:ACP:CARR:FILT:RRC:STAT ON CALC:VECT:TRAC1:ACP:CARR:FILT:RRC:STAT?
Preset:	0
State Saved:	Saved in instrument state.

Common Measurement Functions 2

Initial S/W Revision:	Prior to A.02.00
Modified at S/W Revision:	A.02.00
Help Map ID:	25817

Carrier Filter Alpha

Enables you to adjust the alpha of the RRC filter for the reference (carrier) power measurement.

Key Path:	Trace/Detector, ACP
Mode:	VSA, LTE, LTETDD, IDEN
Measurement:	<meas>:=VECTor ADEMod DDEMod W11A W11B EVM IPOWER IDEMod MOTotalk
Remote Command:	:CALCulate:<meas>:TRACe [1] 2 3 4 :ACPpower:CARRier:FILTer :RRC:ALPHa <real> :CALCulate:<meas>:TRACe [1] 2 3 4 :ACPpower:CARRier:FILTer :RRC:ALPHa?
Example:	CALC:VECT:TRAC1:ACP:CARR:FILT:RRC:ALPH 0.22 CALC:VECT:TRAC1:ACP:CARR:FILT:RRC:ALPH?
Preset:	0.35
State Saved:	Saved in instrument state.
Min:	0
Max:	1
Initial S/W Revision:	Prior to A.02.00
Modified at S/W Revision:	A.02.00
Help Map ID:	25818

Offsets

Accesses a menu that has a key for each offset, and also an Offset RRC weighting on/off key. Each offset key shows a summary of its current parameters. Pressing one of the Offset A|B|C|D|E keys accesses a menu for adjusting its parameters.

The ACP measurement compares power in frequency bands offset from the carrier to power in the reference channel (centered on the carrier). Up to 5 offsets can be defined. The offsets are designated by letters A through E. Each offset is defined by an offset frequency, bandwidth, and optional RRC weighting. An offset actually defines two bands, one above the reference frequency and one below. Each band is used individually in the ACP calculation. RRC weighting can only be turned on or off for all offsets, but each offset can have its own RRC filter alpha. A filter alpha of 0 is the same as no RRC weighting.

Key Path:	Trace/Detector,ACP,Offsets
-----------	-----------------------------------

Mode:	VSA, LTE, LTETDD, IDEN
Initial S/W Revision:	Prior to A.02.00
Modified at S/W Revision:	A.02.00
Help Map ID:	25819

Offset Freq

Turns ACP analysis on or off for a selected offset and sets the offset frequency, which is relative to the carrier frequency.

Key Path:	Trace/Detector, ACP, Offsets, Offset A B C D E
Mode:	VSA, LTE, LTETDD, IDEN
Measurement:	<meas>:=VECTor ADEMod DDEMod W11A W11B EVM IPOWER IDEMod MOTotalk
Remote Command:	:CALCulate:<meas>:TRACe [1] 2 3 4 :ACPpower:OFFSet :LIST:FREQuency <freq>, ... :CALCulate:<meas>:TRACe [1] 2 3 4 :ACPpower:OFFSet :LIST:FREQuency? :CALCulate:<meas>:TRACe [1] 2 3 4 :ACPpower:OFFSet :LIST:STATe OFF ON 0 1, ... :CALCulate:<meas>:TRACe [1] 2 3 4 :ACPpower:OFFSet :LIST:STATe?
Example:	CALC:VECT:TRAC1:ACP:OFFS:LIST:FREQ 1 MHz,1 MHz,500 KHz,500 KHz,1 MHz CALC:VECT:TRAC1:ACP:OFFS:LIST:FREQ? :CALC:VECT:TRAC1:ACP:OFFS:LIST:STAT ON,OFF,OFF,ON,OFF
Notes:	If you send fewer than 5 frequencies in the parameter list, then the remaining offsets frequencies are set to 0. You can send a single on/off parameter or a comma-separated list of up to 5 parameters. These enable/disable each of the Offsets in sequence. Any remaining Offsets are disabled
Preset:	3000000,0,0,0,0 1,0,0,0,0
State Saved:	Saved in instrument state.
Min:	-9.9E+37
Max:	9.9E+37
Initial S/W Revision:	Prior to A.02.00
Modified at S/W Revision:	A.02.00
Help Map ID:	25820

Common Measurement Functions 2

Offset Meas Noise BW

Enables you to set the measurement noise bandwidth for the power measurement of a selected offset band.

Key Path:	Trace/Detector, ACP, Offsets, Offset A B C D E
Mode:	VSA, LTE, LTETDD, IDEN
Measurement:	<meas>:=VECTor ADEMod DDEMod W11A W11B EVM IPOWer IDEMod MOTotalk
Remote Command:	:CALCulate:<meas>:TRACe [1] 2 3 4 :ACPoweR:OFFSet :LIST:BA NDwidth BWIDth:INTEgration <bandwidth>, ... :CALCulate:<meas>:TRACe [1] 2 3 4 :ACPoweR:OFFSet :LIST:BA NDwidth BWIDth:INTEgration?
Example:	CALC:VECT:TRAC1:ACP:OFFS:LIST:BAND:INT 1 MHZ,2 MHZ,3 MHZ,4 MHZ,5 MHZ CALC:VECT:TRAC1:ACP:OFFS:LIST:BAND:INT?
Notes:	If you send fewer than 5 bandwidth parameters in the list, then Measurement Noise Bandwidths for the remaining Offsets are set to 0.
Preset:	1000000,0,0,0,0
State Saved:	Saved in instrument state.
Min:	-9.9e37
Max:	9.9e37
Initial S/W Revision:	Prior to A.02.00
Modified at S/W Revision:	A.02.00
Help Map ID:	25821

Offset Filter Alpha

Enables you to adjust the alpha of the RRC filter for the power measurement of the selected offset band.

Key Path:	Trace/Detector, ACP, Offsets, Offset A B C D E
Mode:	VSA, LTE, LTETDD, IDEN
Measurement:	<meas>:=VECTor ADEMod DDEMod W11A W11B EVM IPOWer IDEMod MOTotalk
Remote Command:	:CALCulate:<meas>:TRACe [1] 2 3 4 :ACPoweR:OFFSet :LIST:FI LTer:RRC:ALPHa <real>, ... :CALCulate:<meas>:TRACe [1] 2 3 4 :ACPoweR:OFFSet :LIST:FI LTer:RRC:ALPHa?
Example:	CALC:VECT:TRAC1:ACP:OFFS:LIST:FILT:RRC:ALPH 0.22,0.22,0.22,0.22,0.22 CALC:VECT:TRAC1:ACP:OFFS:LIST:FILT:RRC:ALPH?

Notes:	You can send a single Filter Alpha for Offset A or a comma-separated list of up to 5 Filter Alpha parameters. These are assigned in sequence to the Offsets. Alpha for any remaining Offsets are set to 0.
Preset:	0.35,0.35,0.35,0.35,0.35
State Saved:	Saved in instrument state.
Min:	0
Max:	1.0
Initial S/W Revision:	Prior to A.02.00
Modified at S/W Revision:	A.02.00
Help Map ID:	25822

Offset Relative Limit

Enables you to turn on/off a relative limit test and set the limit for the selected offset. The test shows a failure if the power in either the upper or lower band at the selected offset exceeds the reference power plus the relative test limit. For example, if the test limit is -60, the reference power is -4.5 dBm, a test failure would be shown if the power in the lower or upper band exceeds -64.5 dBm.

Key Path:	Trace/Detector, ACP, Offsets
Mode:	VSA, LTE, LTETDD, IDEN
Measurement:	<meas>:=VECTor ADEMod DDEMod W11A W11B EVM IPOWER IDEMod MOTotalk
Remote Command:	:CALCulate:<meas>:TRACe [1] 2 3 4 :ACPpower:OFFSet :LIST:RC ARrier <reall>, ... :CALCulate:<meas>:TRACe [1] 2 3 4 :ACPpower:OFFSet :LIST:RC ARrier? :CALCulate:<meas>:TRACe [1] 2 3 4 :ACPpower:OFFSet :LIST:RC ARrier:TEST OFF ON 0 1, ... :CALCulate:<meas>:TRACe [1] 2 3 4 :ACPpower:OFFSet :LIST:RC ARrier:TEST?
Example:	CALC:VECT:TRAC1:ACP:OFFS:LIST:RCAR -50, -55, -60, -65, -80 CALC:VECT:TRAC1:ACP:OFFS:LIST:RCAR? CALC:VECT:TRAC1:ACP:OFFS:LIST:RCAR:TEST 1, 1, 1, 1, 1 CALC:VECT:TRAC1:ACP:OFFS:LIST:RCAR:TEST?
Notes:	You can send a single Limit for Offset A or a comma-separated list of up to 5 limit parameters. These are assigned in sequence to the Offset frequencies with the remaining limits being set to 0. You can send a single on/off parameter or a comma-separated list of up to 5 parameters. These turn the Limit Test on or off for each of the Offsets in sequence. For any remaining Offsets, the Limit test is turned off.

Common Measurement Functions 2

Preset:	-120,-120,-120,-120,-120 0,0,0,0,0
State Saved:	Saved in instrument state.
Min:	50
Max:	-200
Initial S/W Revision:	Prior to A.02.00
Modified at S/W Revision:	A.02.00
Help Map ID:	25823

RRC Weighting (All Offsets)

Turns on or off RRC weighting for the power measurement for all offsets. If RRC weighting is turned on, but you want to exclude RRC weighting for a particular offset, set its filter alpha to 0.

Key Path:	Trace/Detector,ACP,Offsets
Mode:	VSA, LTE, LTETDD, IDEN
Measurement:	<meas>:=VECTor ADEMod DDEMod W11A W11B EVM IPOWer IDEMod MOTotalk
Remote Command:	:CALCulate:<meas>:TRACe [1] 2 3 4 :ACP:Power:OFFSet:FILTer: RRC:STATe OFF ON 0 1 :CALCulate:<meas>:TRACe [1] 2 3 4 :ACP:Power:OFFSet:FILTer: RRC:STATe?
Example:	CALC:VECT:TRAC1:ACP:OFFS:FILT:RRC:STAT ON CALC:VECT:TRAC1:ACP:OFFS:FILT:RRC:STAT?
Preset:	0
State Saved:	Saved in instrument state.
Initial S/W Revision:	Prior to A.02.00
Modified at S/W Revision:	A.02.00
Help Map ID:	25824

OBW Setup (Occupied Bandwidth)

Accesses a menu of functions that enable you to define and turn on the OBW function on the selected trace.

The occupied bandwidth (OBW) function finds and displays the band of frequencies that contain a specified percentage of the total power within the measurement span.

An OBW measurement can be defined for each trace, although it is only active on frequency-domain trace data. The band defined by the OBW measurement is shown as a blue bar overlaying the trace display. To see tabular data showing the frequencies of the band limits, the total power, and so on, you

can assign the OBW Summary (Trace n) to a different trace. For example, you can assign Spectrum data to trace 3, turn on OBW on trace 3, and assign the OBW Summary (Trace 3) to trace 4, as shown below.

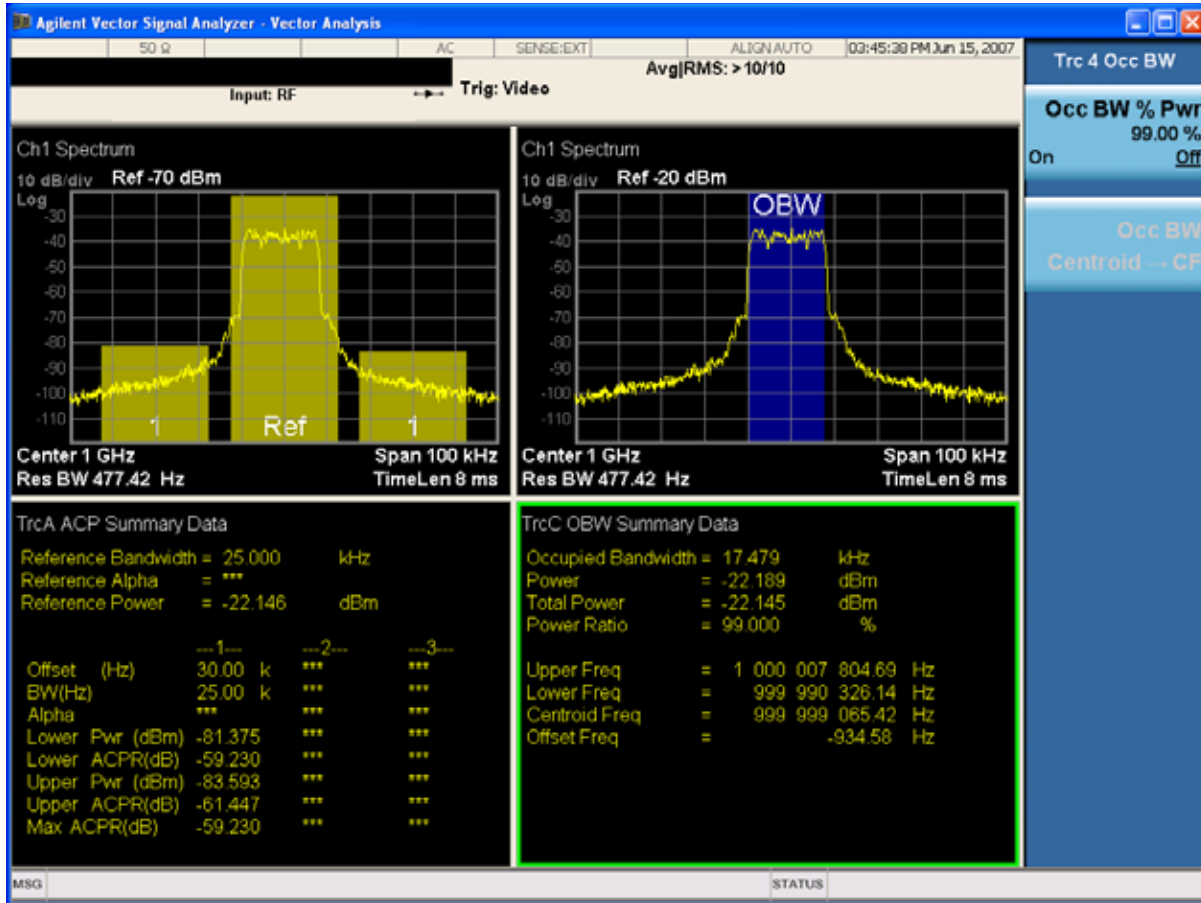

The summary data can be retrieved programmatically using FETCh? or the CALCulate:<meas>:DATA:TABLE commands. See “CALCulate:DATA:TABLE commands” on page 1902 for more details.

Key Path:	Trace/Detector
Mode:	VSA, LTE, LTETDD, IDEN
Readback Text:	[On Off, <num>%]
Initial S/W Revision:	Prior to A.02.00
Modified at S/W Revision:	A.02.00
Help Map ID:	25825

OBW Power

Specifies the percentage of power for determining the occupied BW, and turns the OBW function on or

Common Measurement Functions 2

off for the selected trace.

Key Path:	Trace/Detector, OBW
Mode:	VSA, LTE, LTETDD, IDEN
Measurement:	<meas>:=VECTor ADEMod DDEMod W11A W11B EVM IPOWer IDEMod MOTotalk
Remote Command:	:CALCulate:<meas>:TRACe [1] 2 3 4:OBWidth:PERCent <real> :CALCulate:<meas>:TRACe [1] 2 3 4:OBWidth:PERCent? :CALCulate:<meas>:TRACe [1] 2 3 4:OBWidth:STATe OFF ON 0 1 :CALCulate:<meas>:TRACe [1] 2 3 4:OBWidth:STATe?
Example:	CALC:VECT:TRAC1:OBW:PERC 99 CALC:VECT:TRAC1:OBW:PERC? CALC:VECT:TRAC1:OBW:STAT ON CALC:VECT:TRAC1:OBW:STAT?
Notes:	Parameter is interpreted as a percent, e.g., if you want the OBW to be 95% send 95, not 0.95
Preset:	99.0 0
State Saved:	Saved in instrument state.
Min:	0
Max:	100
Initial S/W Revision:	Prior to A.02.00
Modified at S/W Revision:	A.02.00
Help Map ID:	25780

OBW Centroid > CF

Copies the centroid of the occupied bandwidth to the Center Frequency. It only works if the currently selected trace has data compatible with the OBW function and OBW is turned on.

This is a front-panel function only.

You can read the OBW centroid using the following SCPI-only query and use the result to set the center frequency.

Mode:	VSA, LTE, LTETDD, IDEN
Measurement:	<meas>:=VECTor ADEMod DDEMod W11A W11B EVM IPOWer IDEMod MOTotalk
Remote Command:	:CALCulate:<meas>:TRACe [1] 2 3 4:OBWidth:CENTroid?

Example:	CALC:VECT:TRAC1:OBW:CENT?
Notes:	Query only. Returns NaN (9.91E+37) if the OBW function is not active for the selected trace or is not supported for the trace data assigned to the selected trace.
Initial S/W Revision:	Prior to A.02.00
Modified at S/W Revision:	A.02.00
Help Map ID:	30233

BW Limit

Turns on or off limit testing for the Occupied BW test for the selected trace, and enables you to define the limit. Test pass or fail status appears in the OBW Summary table associated with the trace.

Key Path:	Trace/Detector, OBW
Mode:	VSA, LTE, LTETDD, IDEN
Measurement:	<meas>:=VECTor ADEMod DDEMod W11A W11B EVM IPOWER IDEMod MOTotalk
Remote Command:	:CALCulate:<meas>:TRACe [1] 2 3 4 :OBwidth:LIMit:FBLimit <freq> :CALCulate:<meas>:TRACe [1] 2 3 4 :OBwidth:LIMit:FBLimit? :CALCulate:<meas>:TRACe [1] 2 3 4 :OBwidth:LIMit [:TEST] OFF ON 0 1 :CALCulate:<meas>:TRACe [1] 2 3 4 :OBwidth:LIMit [:TEST] ?
Example:	CALC:VECT:TRAC1:OBW:LIMIT:FBL 10 MHZ CALC:VECT:TRAC1:OBW:LIMIT:FBL? CALC:VECT:TRAC1:OBW:LIMIT:TEST ON CALC:VECT:TRAC1:OBW:LIMIT:TEST?
Preset:	1000000 0
State Saved:	Saved in instrument state.
Min:	1 Hz
Max:	9.9e37 (Infinity) Hz
Initial S/W Revision:	Prior to A.02.00
Modified at S/W Revision:	A.02.00
Help Map ID:	25826

Common Measurement Functions 2

Register

Accesses a menu that enables you to select registers for assignment of trace data.

Key Path:	Trace/Detector, Data
Mode:	VSA, LTE, LTETDD, IDEN
Initial S/W Revision:	Prior to A.02.00
Modified at S/W Revision:	A.02.00
Help Map ID:	25923

Data 1

Select register 1 for assignment of trace data.

Key Path:	Trace/Detector, Data, Register
Mode:	VSA, LTE, LTETDD, IDEN
Initial S/W Revision:	Prior to A.02.00
Modified at S/W Revision:	A.02.00
Help Map ID:	25924

Data 2

Selects register 2 for assignment of trace data.

Key Path:	Trace/Detector, Data, Register
Mode:	VSA, LTE, LTETDD, IDEN
Initial S/W Revision:	Prior to A.02.00
Modified at S/W Revision:	A.02.00
Help Map ID:	25925

Data 3

Selects register 3 for assignment of trace data.

Key Path:	Trace/Detector, Data, Register
Mode:	VSA, LTE, LTETDD, IDEN
Initial S/W Revision:	Prior to A.02.00
Modified at S/W Revision:	A.02.00
Help Map ID:	25926

Data 4

Selects register 4 for assignment of trace data.

Key Path:	Trace/Detector, Data, Register
Mode:	VSA, LTE, LTETDD, IDEN
Initial S/W Revision:	Prior to A.02.00
Modified at S/W Revision:	A.02.00
Help Map ID:	25927

Data 5

Selects register 5 for assignment of trace data.

Key Path:	Trace/Detector, Data, Register
Mode:	VSA
Initial S/W Revision:	Prior to A.02.00
Modified at S/W Revision:	A.02.00
Help Map ID:	25928

Data 6

Selects register 6 for assignment of trace data.

Key Path:	Trace/Detector, Data, Register
Mode:	VSA
Initial S/W Revision:	Prior to A.02.00
Modified at S/W Revision:	A.02.00
Help Map ID:	25929

Trace Indicator Info

Enables you to get more information about why a trace indicator is showing. A trace indicator appears in the upper right corner of a trace display to announce exceptional conditions. When such an indicator is showing on the selected trace, pressing this key causes more information about the condition to appear in the message area. This is a front-panel only function. The SCPI commands for querying the Trace Indicator and the Trace Indicator Info for a particular trace are:

CALC:<meas>:DATA[1]|2|3|4:HEAD:STR? "TrcLedStr"

CALC:<meas>:DATA[1]|2|3|4:HEAD:STR? "TrcLedReason"

Key Path:	Trace/Detector
-----------	-----------------------

Common Measurement Functions 2

Mode:	VSA, LTE, LTETDD, IDEN
Initial S/W Revision:	Prior to A.02.00
Modified at S/W Revision:	A.02.00
Help Map ID:	25896

Limit Test (SCPI Only)

Enables you to enable or disable the Limit Test function for each Trace when the Trace supports the Limit Test function.

When enabled, if the limit test fails on the trace, “FAIL” is shown on the Meas Bar. Otherwise, “PASS” is shown.

Available only for the EVM measurement.

Mode:	VSA, LTE, LTETDD
Measurement:	<meas>:=EVM
Remote Command:	:CALCulate:<meas>:TRACe [1] 2 3 4 :LIMit:VISible OFF ON 0 1 :CALCulate:<meas>:TRACe [1] 2 3 4 :LIMit:VISible?
Example:	CALC:EVM:TRAC1:LIM:VIS ON CALC:EVM:TRAC1:LIM:VIS?
Notes:	On the LTE/LTETDD EVM measurement, the following trace data is supported: In-band Emissions Eq Ch Freq Resp Per Slot Limit data can be queried by :CALC:EVM:DATA[1] 2 3 4? LL UL command.
Preset:	0
State Saved:	Saved in instrument state.
Initial S/W Revision:	A.08.00
Help Map ID:	0

Trigger

Determines when a measurement should start taking data. There are several available trigger sources. For each trigger source, there are associated setup parameters. Typically, a trigger event is generated when a signal (or a characteristic of the signal) crosses a defined trigger level (or threshold) on a rising or falling slope. The measurement begins at a specified time delay from the trigger point. The delay can be negative, enabling pre-trigger data to be taken. Each trigger source has associated its own trigger level, slope, and delay settings.

Trigger Holdoff - Some form of trigger holdoff is available for most trigger types. Hold off can be

defined in different ways, with possible variations depending on trigger slope setting.

Normal: This is the holdoff type that scopes typically use. After a trigger event, for the duration of the holdoff time, no additional trigger events are recognized.

Below Level: If the trigger slope is positive, a trigger event is generated only if the signal characteristic of interest crosses the trigger threshold (with positive slope) after having been below the threshold for at least the holdoff time. For negative slope, the trigger event is generated if the signal characteristic crosses the threshold (with negative slope) and then remains below the threshold for at least the holdoff time. In either case, the trigger event is associated with the time the level was crossed.

Above Level: If the trigger slope is positive, a trigger event is generated only if the signal characteristic of interest crosses the trigger threshold (with positive slope) and then remains above the threshold for at least the holdoff time. For negative slope, the trigger event is generated if the signal characteristic crosses the threshold (with negative slope) after having been above the threshold for at least the holdoff time. In either case, the trigger event is associated with the time the level was crossed.

Key Path:	Front Panel
Mode:	VSA, LTE, LTETDD, IDEN
Initial S/W Revision:	Prior to A.02.00
Modified at S/W Revision:	A.02.00
Help Map ID:	25897

Trig Reference Line

Appears (if enabled) when the trigger source is related to the measured signal. It shows the trigger level relative to the signal. This control enables you to show or hide the trigger reference line.

The trigger reference line, only appears on appropriately formatted time traces. For example, if Video (IF Envelope) trigger is selected, the trigger level line would appear on Main Time, Inst Main Time, or Raw Main Time traces that are formatted as Log Mag or Linear Mag.

Key Path:	Trigger
Mode:	VSA, LTE, LTETDD, IDEN
Remote Command:	:TRIGger [:SEquence] :RLINe OFF ON 0 1 :TRIGger [:SEquence] :RLINe?
Example:	TRIG:RLIN ON TRIG:RLIN?
Preset:	1
State Saved:	Saved in instrument state.
Range:	Show Hide
Initial S/W Revision:	Prior to A.02.00

Common Measurement Functions 2

Modified at S/W Revision:	A.02.00
Help Map ID:	25827

Hardware Trigger

When the Data Source is Inputs, this trigger menu appears. The menu gives you a choice of trigger sources. Once you select a trigger source, you can branch to the setup parameters for that source.

Key Path:	Trigger
Mode:	VSA, LTE, LTETDD, IDEN
Measurement:	<meas>:=VECTor ADEMod DDEMod W11A W11B EVM IPOWER IDEMod MOTotalk
Remote Command:	:TRIGger:<meas>[:SEQuence]:SOURce IMMediate VIDeo EXTernal1 :TRIGger:<meas>[:SEQuence]:SOURce?
Example:	TRIG:VECT:SOUR IMM TRIG:VECT:SOUR?
Notes:	Video triggering is also known by some as IF Envelope or IF Magnitude triggering.
Preset:	IMM
State Saved:	Saved in instrument state.
Range:	Free Run Video (IF Envelope) External 1
Initial S/W Revision:	Prior to A.02.00
Modified at S/W Revision:	A.02.00
Help Map ID:	25828

Free Run

Starts each measurement scan as soon as possible without regard to any signal characteristics or external triggering signal.

Key Path:	Trigger
Mode:	VSA, LTE, LTETDD, IDEN
Initial S/W Revision:	Prior to A.02.00
Modified at S/W Revision:	A.02.00
Help Map ID:	25829

Video (IF Envelope)

Selects Video (IF Envelope) triggering. The trigger condition is met when the magnitude of the signal

you are measuring crosses the defined trigger level while satisfying the slope and holdoff conditions. Specifically, the source for the trigger calculation is the IF signal, filtered only by the brickwall filter that defines the information bandwidth of the signal - signal energy outside the information bandwidth does not affect the triggering.

NOTE This is called Video triggering due to its similarity with swept analyzer zero span measurements being triggered on the video signal. However, in this case there is no video signal. Since the trigger condition applies to the full IF signal, this is also called IF envelope triggering.

If Video triggering is already selected, pressing this softkey accesses the video trigger setup functions and changes the active function to Video Trigger Level.

Key Path:	Trigger
Mode:	VSA, LTE, LTETDD, IDEN
Initial S/W Revision:	Prior to A.02.00
Modified at S/W Revision:	A.02.00
Help Map ID:	25830

Trigger Level

Sets a level (in volts) that the magnitude of the IF signal must cross (with the correct slope) in order to generate a trigger. (Holdoff conditions must also be met.)

Key Path:	Trigger, Video
Mode:	VSA, LTE, LTETDD, IDEN
Remote Command:	:TRIGger[:SEQuence]:VIDeo:LEVel <voltage> :TRIGger[:SEQuence]:VIDeo:LEVel?
Example:	TRIG:VID:LEV 10 MV TRIG:VID:LEV?
Notes:	:TRIGger[:SEQuence]:IF:LEVel <voltage> can be used as an alias
Preset:	10 mV
State Saved:	Saved in instrument state.
Min:	0
Max:	9.9E+37
Initial S/W Revision:	Prior to A.02.00
Modified at S/W Revision:	A.02.00
Help Map ID:	25831

Common Measurement Functions 2

Trig Slope

Controls the trigger polarity. Positive means the trigger occurs when the rising magnitude crosses the trigger level. Negative means the trigger occurs when the falling magnitude crosses the trigger level.

Key Path:	Trigger, Video
Mode:	VSA, LTE, LTETDD, IDEN
Remote Command:	:TRIGger[:SEQuence]:VIDeo:SLOPe POSitive NEGative :TRIGger[:SEQuence]:VIDeo:SLOPe?
Example:	TRIG:VID:SLOP POS TRIG:VID:SLOP?
Notes:	:TRIGger[:SEQuence]:IF:SLOPe POSitive NEGative can also be used
Preset:	POS
State Saved:	Saved in instrument state.
Range:	Pos Neg
Initial S/W Revision:	Prior to A.02.00
Modified at S/W Revision:	A.02.00
Help Map ID:	25832

Trig Delay

Controls the time delay from the trigger point to the actual start of the measurement data. This can be negative to get pre-trigger data.

Key Path:	Trigger, Video
Mode:	VSA, LTE, LTETDD, IDEN
Remote Command:	:TRIGger[:SEQuence]:VIDeo:DELAy <time> :TRIGger[:SEQuence]:VIDeo:DELAy? :TRIGger[:SEQuence]:VIDeo:DELAy:STATe OFF ON 0 1 :TRIGger[:SEQuence]:VIDeo:DELAy:STATe?
Example:	TRIG:VID:DEL 10 MS TRIG:VID:DEL? TRIG:VID:DEL:STAT ON TRIG:VID:DEL:STAT?
Notes:	:TRIGger[:SEQuence]:IF:DELAy <time> can be used as an alias :TRIGger[:SEQuence]:IF:DELAy:STATe can also be used as an alias
Preset:	0 OFF

State Saved:	Saved in instrument state.
Min:	-9.9E+37
Max:	9.9E+37
Initial S/W Revision:	Prior to A.02.00
Modified at S/W Revision:	A.02.00
Help Map ID:	25833

Trig Holdoff

Sets the trigger holdoff time.

Key Path:	Trigger, Video
Mode:	VSA, LTE, LTETDD, IDEN
Remote Command:	:TRIGger[:SEQuence]:VIDeo:HOLDoFF <time> :TRIGger[:SEQuence]:VIDeo:HOLDoFF? :TRIGger[:SEQuence]:VIDeo:HOLDoFF:STATe OFF ON 0 1 :TRIGger[:SEQuence]:VIDeo:HOLDoFF:STATe?
Example:	TRIG:VID:HOLD 1 US TRIG:VID:HOLD? TRIG:VID:HOLD:STAT ON TRIG:VID:HOLD:STAT?
Notes:	:TRIGger[:SEQuence]:IF:HOLDoFF can be used as an alias :TRIGger[:SEQuence]:IF:HOLDoFF:STATe can be used as an alias
Preset:	0 OFF
State Saved:	Saved in instrument state.
Min:	-9.9E+37
Max:	9.9E+37
Initial S/W Revision:	Prior to A.02.00
Modified at S/W Revision:	A.02.00
Help Map ID:	25834

Holdoff Type

Sets the trigger holdoff type. Some form of trigger holdoff is available for most trigger types. Hold off can be defined in different ways, with possible variations depending on trigger slope setting.

Below Level: If the trigger slope is positive, a trigger event is generated only if the signal characteristic of

Common Measurement Functions 2

interest crosses the trigger threshold (with positive slope) after having been below the threshold for at least the holdoff time. For negative slope, the trigger event is generated if the signal characteristic crosses the threshold (with negative slope) and then remains below the threshold for at least the holdoff time. In either case, the trigger event is associated with the time the level was crossed.

Above Level: If the trigger slope is positive, a trigger event is generated only if the signal characteristic of interest crosses the trigger threshold (with positive slope) and then remains above the threshold for at least the holdoff time. For negative slope, the trigger event is generated if the signal characteristic crosses the threshold (with negative slope) after having been above the threshold for at least the holdoff time. In either case, the trigger event is associated with the time the level was crossed.

Key Path:	Trigger, Video
Mode:	VSA, LTE, LTETDD, IDEN
Remote Command:	:TRIGger[:SEquence]:VIDeo:HOLDoff:TYPE BELow ABOve :TRIGger[:SEquence]:VIDeo:HOLDoff:TYPE?
Example:	TRIG:VID:HOLD:TYPE BEL TRIG:VID:HOLD:TYPE?
Notes:	:TRIGger[:SEquence]:IF:HOLDoff:TYPE can be used as an alias
Preset:	BEL
State Saved:	Saved in instrument state.
Range:	Below Level Above Level
Initial S/W Revision:	Prior to A.02.00
Modified at S/W Revision:	A.02.00
Help Map ID:	25835

External 1

Selects the signal on the Trigger 1 input as the trigger signal. The trigger condition is met when the level of the external trigger signal crosses the defined trigger level while satisfying the slope and holdoff conditions.

Note that currently, the VSA based measurements do not support External 2 triggering.

If External 1 triggering is already selected, pressing this softkey accesses the external 1 trigger setup functions and changes the active function to Ext 1 Trigger Level.

Key Path:	Trigger
Mode:	VSA, LTE, LTETDD, IDEN
Initial S/W Revision:	Prior to A.02.00
Modified at S/W Revision:	A.02.00
Help Map ID:	25836

Trigger Level

Sets a level (in volts) that the Trigger signal must cross (with the correct slope) in order to generate a trigger. Holdoff conditions must also be met.

Key Path:	Trigger, External 1
Mode:	VSA, LTE, LTETDD, IDEN
Remote Command:	:TRIGger[:SEquence]:EXTernal1:LEVel <voltage> :TRIGger[:SEquence]:EXTernal1:LEVel?
Example:	TRIG:EXT1:LEV 10 MV TRIG:EXT1:LEV?
Preset:	1 V
State Saved:	Saved in instrument state.
Min:	-9.9E+37
Max:	9.9E+37
Initial S/W Revision:	Prior to A.02.00
Modified at S/W Revision:	A.02.00
Help Map ID:	25837

Trig Slope

Controls the trigger polarity. Positive means the trigger occurs on a rising edge. Negative means the trigger occurs on a falling edge.

Key Path:	Trigger, External 1
Mode:	VSA, LTE, LTETDD, IDEN
Remote Command:	:TRIGger[:SEquence]:EXTernal1:SLOPe POSitive NEGative :TRIGger[:SEquence]:EXTernal1:SLOPe?
Example:	TRIG:EXT1:SLOP POS TRIG:EXT1:SLOP?
Preset:	POS
State Saved:	Saved in instrument state.
Range:	Pos Neg
Initial S/W Revision:	Prior to A.02.00
Modified at S/W Revision:	A.02.00
Help Map ID:	25838

Common Measurement Functions 2

Trig Delay

Controls the time delay from the trigger point to the actual start of the measurement data. This can be negative to get pre-trigger data.

Key Path:	Trigger, External 1
Mode:	VSA, LTE, LTETDD, IDEN
Remote Command:	:TRIGger[:SEquence]:EXTErnal1:DELAy <time> :TRIGger[:SEquence]:EXTErnal1:DELAy? :TRIGger[:SEquence]:EXTErnal1:DELAy:STATe OFF ON 0 1 :TRIGger[:SEquence]:EXTErnal1:DELAy:STATe?
Example:	TRIG:EXT1:DEL 10 MS TRIG:EXT1:DEL? TRIG:EXT1:DEL:STAT ON TRIG:EXT1:DEL:STAT?
Preset:	0 0
State Saved:	Saved in instrument state.
Min:	-9.9E+37
Max:	9.9E+37
Initial S/W Revision:	Prior to A.02.00
Modified at S/W Revision:	A.02.00
Help Map ID:	25839

Trig Holdoff

Sets the trigger holdoff time.

Key Path:	Trigger, External 1
Mode:	VSA, LTE, LTETDD, IDEN
Remote Command:	:TRIGger[:SEquence]:EXTErnal1:HOLDOff <time> :TRIGger[:SEquence]:EXTErnal1:HOLDOff? :TRIGger[:SEquence]:EXTErnal1:HOLDOff:STATe OFF ON 0 1 :TRIGger[:SEquence]:EXTErnal1:HOLDOff:STATe?
Example:	TRIG:EXT1:HOLD 1 US TRIG:EXT1:HOLD? TRIG:EXT1:HOLD:STAT ON TRIG:EXT1:HOLD:STAT?

Preset:	0 0
State Saved:	Saved in instrument state.
Min:	-9.9E+37
Max:	9.9E+37
Initial S/W Revision:	Prior to A.02.00
Modified at S/W Revision:	A.02.00
Help Map ID:	25840

Holdoff Type

Sets the trigger holdoff type. Some form of trigger holdoff is available for most trigger types. Holdoff can be defined in different ways, with possible variations depending on trigger slope setting.

Below Level: If the trigger slope is positive, a trigger event is generated only if the signal characteristic of interest crosses the trigger threshold (with positive slope) after having been below the threshold for at least the holdoff time. For negative slope, the trigger event is generated if the signal characteristic crosses the threshold (with negative slope) and then remains below the threshold for at least the holdoff time. In either case, the trigger event is associated with the time the level was crossed.

Above Level: If the trigger slope is positive, a trigger event is generated only if the signal characteristic of interest crosses the trigger threshold (with positive slope) and then remains above the threshold for at least the holdoff time. For negative slope, the trigger event is generated if the signal characteristic crosses the threshold (with negative slope) after having been above the threshold for at least the holdoff time. In either case, the trigger event is associated with the time the level was crossed.

Key Path:	Trigger, External 1
Mode:	VSA, LTE, LTETDD, IDEN
Remote Command:	:TRIGger[:SEquence]:EXTernal1:HOLDoff:TYPE BELow ABOVe :TRIGger[:SEquence]:EXTernal1:HOLDoff:TYPE?
Example:	TRIG:EXT1:HOLD:TYPE BEL TRIG:EXT1:HOLD:TYPE?
Preset:	BEL
State Saved:	Saved in instrument state.
Range:	Below Level Above Level
Initial S/W Revision:	Prior to A.02.00
Modified at S/W Revision:	A.02.00
Help Map ID:	25841

Free Run

Selecting this trigger source means the measurement immediately begins taking data starting at the next

Common Measurement Functions 2

available point in the recording.

Key Path:	Trigger, Playback Trigger
Mode:	VSA, LTE, LTETDD, IDEN
Help Map ID:	30180

IF Envelope

Selects IF Envelope triggering. The trigger condition is met when the calculated magnitude of the data in the recording (i.e., the absolute value of real data or the vector magnitude of complex data) crosses the defined trigger level while satisfying the slope and holdoff conditions. There is no filtering or smoothing of the magnitude data.

NOTE Although analysis of recorded data enables you to choose a different span and center frequency within the bandwidth limits of the original recording, the original bandwidth of the recorded data is used for trigger calculations.

If IF Envelope triggering is already selected, pressing this softkey accesses the IF Envelope trigger setup functions and changes the active function to IF Envelope Trigger Level.

Key Path:	Trigger
Mode:	VSA, LTE, LTETDD, IDEN
Help Map ID:	25843

Trigger Level

Sets a level (in volts) that the magnitude of the IF signal must cross (with the correct slope) in order to generate a trigger.

NOTE Holdoff conditions must also be met.

Key Path:	Trigger, IF Envelope
Mode:	VSA, LTE, LTETDD, IDEN
Remote Command:	:TRIGger[:SEQuence]:RECOrding:VIDeo:LEVel <voltage> :TRIGger[:SEQuence]:RECOrding:VIDeo:LEVel?
Example:	TRIG:REC:VID:LEV 10 MV TRIG:REC:VID:LEV?
Notes:	:TRIGger[:SEQuence]:RECOrding:IF:LEVel <voltage> can be used as an alias
Preset:	1 V
State Saved:	Saved in instrument state.

Min:	0
Max:	9.9E+37
Help Map ID:	25844

Trig Slope

Controls the trigger polarity. Positive means the trigger occurs when the rising magnitude crosses the trigger level. Negative means the trigger occurs when the falling magnitude crosses the trigger level.

Key Path:	Trigger, Video
Mode:	VSA, LTE, LTETDD, IDEN
Remote Command:	:TRIGger[:SEquence]:RECORDing:VIDeo:SLOPe POSitive NEGative :TRIGger[:SEquence]:RECORDing:VIDeo:SLOPe?
Example:	TRIG:REC:VID:SLOP POS TRIG:REC:VID:SLOP?
Notes:	:TRIGger[:SEquence]:RECORDing:IF:SLOPe can be used as an alias
Preset:	POS
State Saved:	Saved in instrument state.
Range:	Pos Neg
Help Map ID:	25845

Trig Delay

Controls the time delay from the trigger point to the actual start of the measurement data. This can be negative to get pre-trigger data.

Key Path:	Trigger, Video
Mode:	VSA, LTE, LTETDD, IDEN
Remote Command:	:TRIGger[:SEquence]:RECORDing:VIDeo:DELay <time> :TRIGger[:SEquence]:RECORDing:VIDeo:DELay? :TRIGger[:SEquence]:RECORDing:VIDeo:DELay:STATe OFF ON 0 1 :TRIGger[:SEquence]:RECORDing:VIDeo:DELay:STATe?
Example:	TRIG:REC:VID:DEL 10 MS TRIG:REC:VID:DEL? TRIG:REC:VID:DEL:STAT ON TRIG:REC:VID:DEL:STAT?

Common Measurement Functions 2

Notes:	:TRIGger[:SEQuence]:RECOrding:IF:DELAy <time> can be used as an alias :TRIGger[:SEQuence]:RECOrding:IF:DELAy:STATe can be used as an alias
Preset:	0 0
State Saved:	Saved in instrument state.
Min:	-9.9E+37
Max:	9.9E+37
Help Map ID:	25846

Trig Holdoff

Sets the trigger holdoff time.

Key Path:	Trigger, Video
Mode:	VSA, LTE, LTETDD, IDEN
Remote Command:	:TRIGger [:SEQuence] :RECOrding:VIDeo:HOLDoff <time> :TRIGger [:SEQuence] :RECOrding:VIDeo:HOLDoff? :TRIGger [:SEQuence] :RECOrding:VIDeo:HOLDoff:STATe OFF ON 0 1 :TRIGger [:SEQuence] :RECOrding:VIDeo:HOLDoff:STATe?
Example:	TRIG:REC:VID:HOLD 1 US TRIG:REC:VID:HOLD? TRIG:REC:VID:HOLD:STAT ON TRIG:REC:VID:HOLD :STAT?
Notes:	:TRIGger[:SEQuence]:RECOrding:IF:HOLDoff can be used as an alias :TRIGger[:SEQuence]:RECOrding:IF:HOLDoff:STATe can be used as an alias
Preset:	0 0
State Saved:	Saved in instrument state.
Min:	-9.9E+37
Max:	9.9E+37
Help Map ID:	25847

Holdoff Type

Sets the trigger holdoff type.

Some form of trigger holdoff is available for most trigger types. Hold off can be defined in different ways, with

possible variations depending on trigger slope setting.

Below Level: If the trigger slope is positive, a trigger event is generated only if the signal characteristic of interest crosses the trigger threshold (with positive slope) after having been below the threshold for at least the holdoff time. For negative slope, the trigger event is generated if the signal characteristic crosses the threshold (with negative slope) and then remains below the threshold for at least the holdoff time. In either case, the trigger event is associated with the time the level was crossed.

Above Level: If the trigger slope is positive, a trigger event is generated only if the signal characteristic of interest crosses the trigger threshold (with positive slope) and then remains above the threshold for at least the holdoff time. For negative slope, the trigger event is generated if the signal characteristic crosses the threshold (with negative slope) after having been above the threshold for at least the holdoff time. In either case, the trigger event is associated with the time the level was crossed.

Key Path:	Trigger, Video
Mode:	VSA, LTE, LTETDD, IDEN
Remote Command:	:TRIGger[:SEquence]:RECOrding:VIDeo:HOLDoff:TYPE BELOW ABOVE :TRIGger[:SEquence]:RECOrding:VIDeo:HOLDoff:TYPE?
Example:	TRIG:REC:VID:HOLD:TYPE BEL TRIG:REC:VID:HOLD:TYPE?
Notes:	:TRIGger[:SEquence]:RECOrding:IF:HOLDoff:TYPE can be used as an alias
Preset:	BEL
State Saved:	Saved in instrument state.
Range:	Below Level Above Level
Help Map ID:	25848

Baseband

Selects Baseband triggering. It is equivalent to oscilloscope triggering.

NOTE This trigger type is most useful with recorded data that is real (baseband). It is enabled (though not very useful) when the data is complex. In this case the only the real part of the data is used to calculate the trigger condition.

The trigger condition is met when the signal (or the real part of the complex signal) crosses the defined trigger level while satisfying the slope and holdoff conditions. The measurement starts at the trigger point plus the Trigger Delay. Note that the trigger delay can be negative, causing the measurement to start before the trigger point.

If Level triggering is already selected, pressing this softkey accesses the trigger setup functions and changes the active function to Level Trigger Level.

Key Path:	Trigger
-----------	----------------

Common Measurement Functions 2

Mode:	VSA, LTE, LTETDD, IDEN
Help Map ID:	25849

Trigger Level

Sets a level (in volts) that the trigger signal must cross (with the correct slope) in order to generate a trigger. (Holdoff conditions must also be met.)

Key Path:	Trigger, Threshold
Mode:	VSA, LTE, LTETDD, IDEN
Remote Command:	:TRIGger[:SEQUence]:RECORDing:BASEband:LEVel <voltage> :TRIGger[:SEQUence]:RECORDing:BASEband:LEVel?
Example:	TRIG:REC:BAS:LEV 10 MV TRIG:REC:BAS:LEV?
Preset:	0 V
State Saved:	Saved in instrument state.
Min:	-9.9E+37
Max:	9.9E+37
Help Map ID:	25850

Trig Slope

Controls the trigger polarity. Positive means the trigger occurs on a rising edge. Negative means the trigger occurs on a falling edge.

Key Path:	Trigger, Threshold
Mode:	VSA, LTE, LTETDD, IDEN
Remote Command:	:TRIGger[:SEQUence]:RECORDing:BASEband:SLOPe POSitive NEGative :TRIGger[:SEQUence]:RECORDing:BASEband:SLOPe?
Example:	TRIG:REC:BAS:SLOP POS TRIG:REC:BAS:SLOP?
Preset:	POS
State Saved:	Saved in instrument state.
Range:	Pos Neg
Help Map ID:	25851

Trig Delay

Controls the time delay from the trigger point to the actual start of the measurement data. This can be negative to

get pre-trigger data.

Key Path:	Trigger, Threshold
Mode:	VSA, LTE, LTETDD, IDEN
Remote Command:	:TRIGger[:SEquence]:RECOrding:BASEband:DELAy <time> :TRIGger[:SEquence]:RECOrding:BASEband:DELAy? :TRIGger[:SEquence]:RECOrding:BASEband:DELAy:STATe OFF ON 0 1 :TRIGger[:SEquence]:RECOrding:BASEband:DELAy:STATe?
Example:	TRIG:REC:BAS:DEL 10 MS TRIG:REC:BAS:DEL? TRIG:REC:BAS:DEL:STAT ON TRIG:REC:BAS:DEL:STAT?
Preset:	0 0
State Saved:	Saved in instrument state.
Min:	-9.9E+37
Max:	9.9E+37
Help Map ID:	25852

Trig Holdoff

Sets the trigger holdoff time.

Key Path:	Trigger, Threshold
Mode:	VSA, LTE, LTETDD, IDEN
Remote Command:	:TRIGger[:SEquence]:RECOrding:BASEband:HOLDoff <time> :TRIGger[:SEquence]:RECOrding:BASEband:HOLDoff?
Example:	TRIG:REC:BAS:HOLD 1 US TRIG:REC:BAS:HOLD? TRIG:REC:BAS:HOLD:STAT ON TRIG:REC:BAS:HOLD:STAT?
Preset:	0 0
State Saved:	Saved in instrument state.
Min:	-9.9E+37

Common Measurement Functions 2

Max:	9.9E+37
Help Map ID:	25853

Holdoff Type

Sets the trigger holdoff type.

Some form of trigger holdoff is available for most trigger types. Hold off can be defined in different ways, with possible variations depending on trigger slope setting.

Below Level: If the trigger slope is positive, a trigger event is generated only if the signal characteristic of interest crosses the trigger threshold (with positive slope) after having been below the threshold for at least the holdoff time. For negative slope, the trigger event is generated if the signal characteristic crosses the threshold (with negative slope) and then remains below the threshold for at least the holdoff time. In either case, the trigger event is associated with the time the level was crossed.

Above Level: If the trigger slope is positive, a trigger event is generated only if the signal characteristic of interest crosses the trigger threshold (with positive slope) and then remains above the threshold for at least the holdoff time. For negative slope, the trigger event is generated if the signal characteristic crosses the threshold (with negative slope) after having been above the threshold for at least the holdoff time. In either case, the trigger event is associated with the time the level was crossed.

Key Path:	Trigger, Threshold
Mode:	VSA, LTE, LTETDD, IDEN
Remote Command:	:TRIGger[:SEquence]:RECOrding:BASEband:HOLDoff:TYPE BELow ABOVe :TRIGger[:SEquence]:RECOrding:BASEband:HOLDoff:TYPE?
Example:	TRIG:REC:BAS:HOLD:TYPE BEL TRIG:REC:BAS:HOLD:TYPE?
Preset:	BEL
State Saved:	Saved in instrument state.
Range:	Below Level Above Level
Help Map ID:	25854

View/Display

Enables you to set many display properties. Many View Preset softkeys appear under this menu. These set up measurement-specific views, which are described in individual measurements. A view in this application is simply a preset; that is, a choice of layout, trace data assignment, and trace formatting and scaling. After a view preset is performed, the resulting arrangement can then be changed by any available trace manipulation functions or by changing the layout. All measurements have a default view that is used when they are first started, and the first listed preset view restores that arrangement without otherwise affecting the measurement.

This menu contains keys that enable control over the way data is displayed. The Layout key is described

here. Other keys specific to measurements are described in their own descriptions.

Key Path:	Front Panel
Mode:	VSA, LTE, LTETDD, IDEN
Initial S/W Revision:	Prior to A.02.00
Modified at S/W Revision:	A.02.00
Help Map ID:	25898

Layout

Enables you to choose the number and position of windows on the screen. Each window contains one trace. The selected trace is always visible and its window outlined in green. The Window zoom key toggles between multiple windows and a single window mode without changing the setting for Layout.

Single layout has one window.

Stack 2 layout has two windows, one on top of the other, that display either traces 1 (top) and 2 (bottom) or traces 3 and 4. The pair that is showing always includes the selected trace.

Stack 3 layout has three windows that display, top to bottom, traces 1, 2, 3 or traces 2, 3, 4.

Grid 2x2 layout has 4 windows, arranged 2x2. They display (in order top to bottom, left to right) traces 1, 2, 3, and 4.

Common Measurement Functions 2

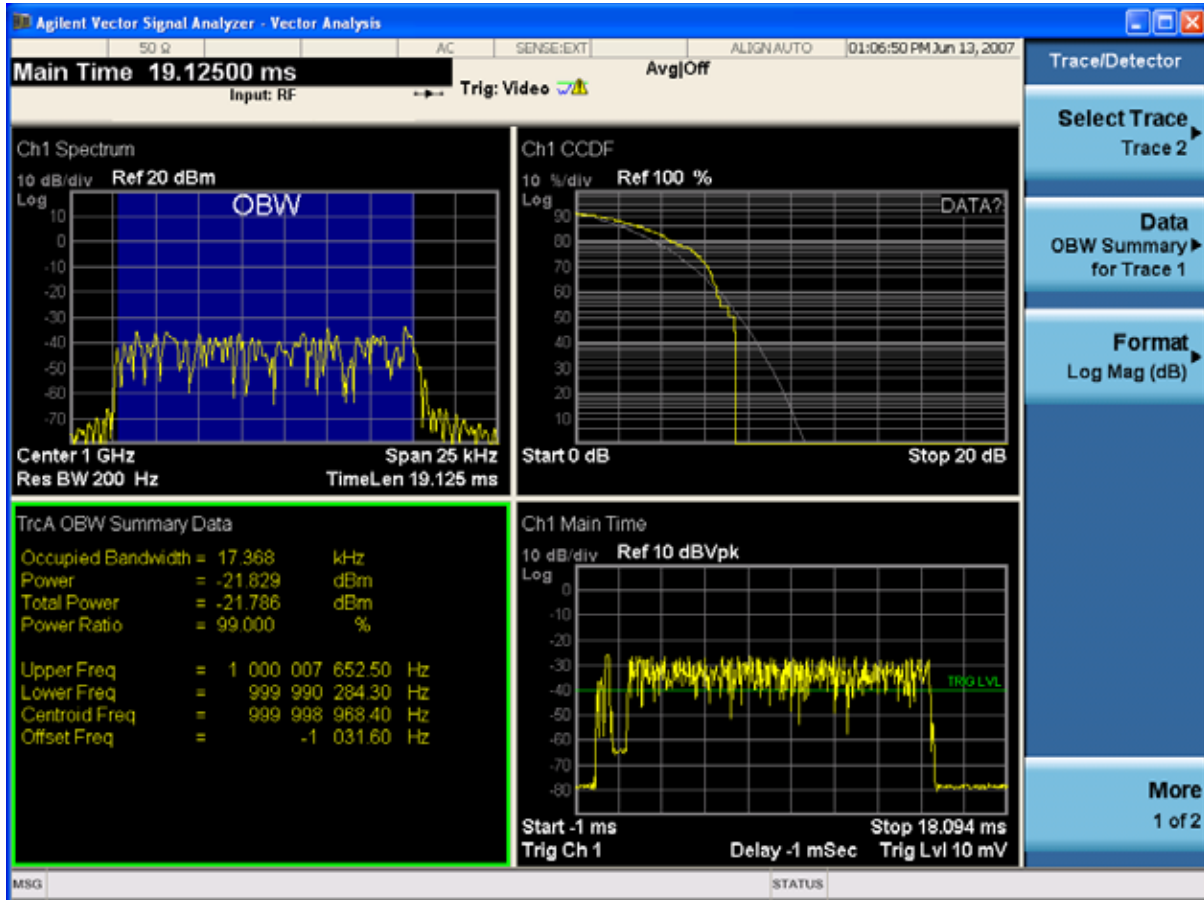

Grid 2x2 layout with Trace 2 selected

There are two other layouts that are available for iDEN Power, iDEN Demod, and MOTOTalk measurements since these enable 6 traces.

Grid 2x3 layout has 2 rows of 3 windows that display all 6 traces in order, top to bottom, then left to right.

Grid 3x2 layout has 3 rows of 2 windows that display all 6 traces in order, top to bottom, then left to right.

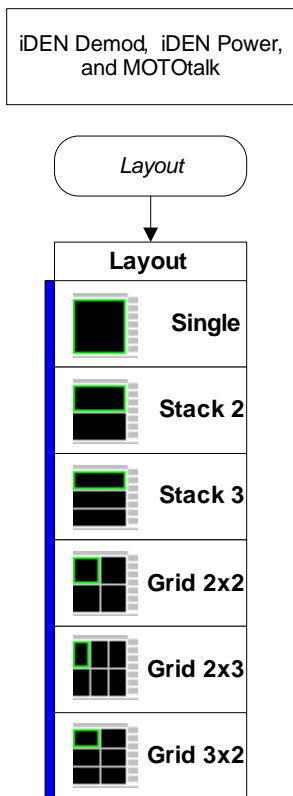

Key Path:	View/Display
Mode:	VSA, LTE, LTETDD, IDEN
Measurement:	<meas>:=VECTor ADEMod DDEMod W11A W11B EVM IPOWER IDEMod MOTotalk
Remote Command:	:DISPlay:<meas>:WINDow:FORMat SINGLE TWO TRI QUAD :DISPlay:<meas>:WINDow:FORMat? For iDEN Power, iDEN Demod and MotoTalk measurements: :DISPlay:<meas>:WINDow:FORMat SINGLE TWO TRI QUAD GR2X3 GR3X2 :DISPlay:<meas>:WINDow:FORMat?
Example:	DISP:VECT:WIND:FORM TWO DISP:IPOW:WIND:FORM GR2X3 DISP:VECT:WIND:FORM?
Couplings:	If the window is currently zoomed, selecting a layout (even the current one) switches it to tiled mode.
Preset:	TWO QUAD QUAD QUAD QUAD QUAD QUAD QUAD GR2X3 TRI
State Saved:	Saved in instrument state.
Range:	Single Stack 2 Stack 3 Grid 2x2 Grid 2x2 Grid 2x3 Stack 3

Common Measurement Functions 2

Initial S/W Revision:	Prior to A.02.00
Modified at S/W Revision:	A.02.00
Help Map ID:	25855

Remote SCPI Commands and Data Queries

Remote SCPI Results described in this section include:

“:READ and :FETCh Commands” on page 1894

“:CALCulate:DATA” on page 1898

“:CALCulate:DATA:RAW” on page 1900

“:CALCulate:DATA:RAW:COMPLex” on page 1900

“:CALCulate:DATA:POINts commands” on page 1900

“:CALCulate:DATA:TABL commands” on page 1902

“:CALCulate:DATA:HEADer commands” on page 1906

“:CALC:CLIMits:FAIL?” on page 1908

“IQ Data Transfers ” on page 1908

VSA based Measurements produce a rich variety of results that can be displayed in any of 4 traces. A result can consist of an array of X,Y trace data that is typically shown as a graph or scalar results that are displayed as a table. The Symbol/Error result that is part of many demodulation measurements actually displays both a trace table (the error statistics) and trace data (the symbol information, which is not graphed but listed). The CALC:<meas>:DATA<n> commands enable you to retrieve any trace data or trace table. This family of commands also enable you to get information about the names of data results available and the units associated with them, as well as names and results of meta-data associated with traces.

Selected results are available via the FETCh and READ SCPI interfaces. These commands refer to data results by arbitrary index number rather than by trace number.

Key Path:	SCPI Only
Mode:	LTE, LTETDD, IDEN, VSA
Help Map ID:	30187

:READ and :FETCh Commands

The SCPI MEASure, READ, and FETCh are typically offered by applications with focus on manufacturing test, where a fixed set of desired results is known in advance and seldom changes. The VSA based measurements are many, due to a focus on development. Thus, for most VSA based measurements there is no standard configuration that yields a useful measurement 90% of the time. Thus, the MEASure function is not offered for most measurements in the VSA Application. However, READ and FETCh can be implemented for select results. Note that these results are also still available using the CALC:<meas>:DATA:TABLE family of commands.

ACP and OBW are available in all VSA based measurements. To retrieve the ACP or OBW data, the function must be enabled on a frequency-domain trace and the associated summary data table must be assigned to another trace. Note however, the index n in the following commands is not trace number but an index picked out of the tables shown below.

:FETCh: <meas> [n] ?

:READ: <meas> [n] ?

The results available for various values of n are shown below:

Condition	N	Results Returned
Mode = VSA LTE IDEN	Not specified or n=1	Reserved for selected results of VSA measurements. If not used for a particular measurement, no result is returned and error -114 Header suffix out of range is generated.
Mode = VSA LTE IDEN	2 – 50	Reserved for selected results of VSA measurements. If not used for a particular measurement, no result is returned and error -114 Header suffix out of range is generated.

Common Measurement Functions 2

<p>Mode = VSA LTE IDEN, ACP on trace 1</p>	<p>51</p>	<p>ACP Summary for trace 1</p> <p>Returns 28 comma-separated scalar results, corresponding to the swept ACP results where possible; n/a elsewhere:</p> <p>Returns 28 comma-separated scalar results, in the following order.</p> <ol style="list-style-type: none"> 1. 0.0 2. Total carrier power (dBm) (same as item 4, because only 1 carrier supported) 3. 0.0 4. Reference carrier power (dBm) 5. Lower offset A - relative power (dB) 6. Lower offset A - absolute power (dBm) 7. Upper offset A - relative power (dB) 8. Upper offset A - absolute power (dBm) 9. Lower offset B - relative power (dB) 10. Lower offset B - absolute power (dBm) 11. Upper offset B - relative power (dB) 12. Upper offset B - absolute power (dBm) ... 21. Lower offset E - relative power (dB) 22. Lower offset E - absolute power (dBm) 23. Upper offset E - relative power (dB) 24. Upper offset E - absolute power (dBm) 25. n/a 26. n/a 27. n/a 28. n/a <p>29. Overall ACP test result summary (0 indicates at least 1 failure, 1 indicates all passed)</p> <p>If any result is not available, NaN (9.91 E 37) is returned. This can happen if ACP is turned off (all results unavailable) or when an offset is entirely off-screen. In the case where it is partially off-screen, the measured result is returned even though its validity is questionable.</p>
<p>Mode = VSA LTE IDEN, ACP on trace 2</p>	<p>52</p>	<p>ACP Summary for trace 2</p> <p>see list for trace 1 summary</p>
<p>Mode = VSA LTE IDEN, ACP on trace 3</p>	<p>53</p>	<p>ACP Summary for trace 3</p> <p>see list for trace 1 summary</p>

Common Measurement Functions 2

Mode = VSA LTE IDEN, ACP on trace 4	54	ACP Summary for trace 4 see list for trace 1 summary
Mode = VSA LTE IDEN, ACP on trace 5	55	ACP Summary for trace 5 see list for trace 1 summary
Mode = VSA LTE IDEN, ACP on trace 6	56	ACP Summary for trace 6 see list for trace 1 summary
	57–60	no result returned; error –114, Header suffix out of range generated
Mode = VSA LTE IDEN, OBW on trace 1	61	OBW Summary for trace 1 Returns 9 comma-separated scalar results corresponding exactly to the items in the OBW Summary trace: <ol style="list-style-type: none"> 1. OBW (Hz) 2. Pwr (dBm) 3. Total Pwr (dBm) 4. Pwr Ratio (no unit, E.g. 0.99) 5. OBW upper freq (Hz) 6. OBW lower freq (Hz) 7. Centroid freq (Hz) 8. Offset freq (Hz) 9. OBW Test Result (0 for fail, 1 for pass) If the results are not available, NaN (9.91 E 37) is returned.
Mode = VSA LTE IDEN, OBW on trace 2	62	OBW Summary for trace 2 see list for trace 1 summary
Mode = VSA LTE IDEN, OBW on trace 3	63	OBW Summary for trace 3 see list for trace 1 summary
Mode = VSA LTE IDEN, OBW on trace 4	64	OBW Summary for trace 4 see list for trace 1 summary
Mode = VSA LTE IDEN, OBW on trace 5	65	OBW Summary for trace 5 see list for trace 1 summary

Common Measurement Functions 2

Mode = VSA LTE IDEN, OBW on trace 6	66	OBW Summary for trace 6 see list for trace 1 summary
--	----	---

Key Path:	SCPI Only
Mode:	LTE, LTETDD, IDEN, VSA
Help Map ID:	0

:CALCulate:DATA

Once measurement data result is assigned to a trace, the data can be retrieved by using one of the following commands (where <n> is the trace number and <meas> is the current VSA based measurement).

:CALC:<meas>:DATA<n>?

:CALC:<meas>:DATA<n>:RAW?

The first form of the command retrieves the data as formatted on the display. For example, if (in a vector measurement) you have the Spectrum result in LogMag format on trace 1, then

:CALC:VECT:DATA1?

returns an array of spectrum amplitude (Y data) in units of dBm, and

:CALC:VECT:DATA1:RAW?

returns the Y data in its underlying units of Volts (peak) squared.

(To get data from displayed tables, see “:CALCulate:DATA:TABL commands” on page 1902.)

The CALC:<meas>:DATA commands get data from traces. There are many results available from a VSA based measurement and only 4 traces in which to view them. View Preset commands are one way of displaying frequently-used results in standard trace locations. Or you can assign any measurement result to any trace using the softkeys under Trace/Detector, Data. The SCPI command for doing this is:

:DISP:<meas>:TRAC<n>:FEED "<data_name>"

For example, if (in a vector measurement) you want to view the CCDF result in trace 4, you send:

:DISP:VECT:TRAC4:FEED "CCDF1"

(If the measurement has not run yet, use INIT:IMM to run it.) Then the CCDF data can be retrieved using

CALC:VECT:DATA4?

or

CALC:VECT:DATA4:RAW?

Key Path:	SCPI Only
Mode:	VSA, LTE, LTETDD, IDEN

Measurement:	<meas>:=VECTor ADEMod DDEMod W11A W11B EVM IPOWER IDEMod MOTotalk
Remote Command:	:CALCulate:<meas>:DATA [1] 2 3 4? [Y X XY [, OFF ON 0 1] LL UL]
Example:	CALC:VECT:DATA1? CALC:VECT:DATA1? Y,ON CALC:VECT:DATA1? X CALC:VECT:DATA1? XY
Notes:	<p>Query only. This retrieves the data in the designated trace as displayed.</p> <p>For example, if Trace 1 is assigned Spectrum data and formatted as LogMag, then :CALC:VECT:DATA1? returns the Y data in dBm. If the X axis is scaled to show only a portion of the trace data, only the data shown is returned.</p> <p>The numeric format of the returned data is controlled by FORMat[:TRACe][:DATA] command</p> <p>The optional parameters control what data is returned.</p> <p>:CALC:VECT:DATA1? Y is the same as :CALC:VECT:DATA1? with no parameter. It returns an array of Y values.</p> <p>:CALC:VECT:DATA1? X returns an array of X values that correspond to the Y values above.</p> <p>:CALC:VECT:DATA1? XY returns interleaved X and Y data. That is: <x1><y1><x2><y2>...</p> <p>Normally, this command only returns the data between the current X scale limits. If the optional ",OFF" or ",0" switch is included at the end of the command, then all data is returned (regardless of X scaling or the state of All Frequency Points).</p> <p>:CALC:EVM:DATA1? LL UL returns an array of Lower/Upper Limit values when Limit Test is enabled and the trace includes limit values. When Limit Test is disabled or the trace does not include limit value, this query is the same as :CALC:EVM:DATA1? with no parameter.</p> <p>Note: LL and UL are available only for the EVM measurement in the LTE/LTE TDD modes.</p> <p>Note: the X and Y parameters in this command refer to the display's horizontal and vertical axes. Normally the X axis is the independent variable, but if the display format is Constellation or IQ, then</p> <p>CALC:<meas>:DATA<n>? [Y] returns the imaginary part of the data and CALC:<meas>:DATA<n>? X returns the real part of the data. If you want the values of the independent variable, change to a non-vector format (such as Log Mag) and use CALC:<meas>:DATA<n>? X</p>
Initial S/W Revision:	Prior to A.02.00
Modified at S/W Revision:	A.02.00, A.08.00
Help Map ID:	25716

Common Measurement Functions 2

:CALCulate:DATA:RAW

Retrieves trace data in its underlying units, before the formatting calculation that converts it to displayed units. Underlying units are typically Volts peak (for signal results) or Volts peak squared (for power results). All data points are returned, whether or not they are displayed.

Key Path:	SCPI Only
Mode:	VSA, LTE, LTETDD, IDEN
Measurement:	<meas>:=VECTor ADEMod DDEMod W11A W11B EVM IPOWer IDEMod MOTotalk
Remote Command:	:CALCulate:<meas>:DATA[1] 2 3 4 :RAW?
Example:	CALC:VECT:DATA1:RAW?
Notes:	Query only. This retrieves the unformatted Y data in the designated trace. If Y data is complex, it is returned as <y_real1><y_imag1><y_real2><y_imag2> etc.
Initial S/W Revision:	Prior to A.02.00
Modified at S/W Revision:	A.02.00
Help Map ID:	25717

:CALCulate:DATA:RAW:COMPLex

Determines if the data retrieved by CALC:<meas>:DATA:RAW<n>? is complex.

Key Path:	SCPI Only
Mode:	VSA, LTE, LTETDD, IDEN
Measurement:	<meas>:=VECTor ADEMod DDEMod W11A W11B EVM IPOWer IDEMod MOTotalk
Remote Command:	:CALCulate:<meas>:DATA[1] 2 3 4 :RAW:COMPLex?
Example:	CALC:VECT:DATA1:RAW:COMP?
Notes:	Query only. Returns 1 if the trace data is complex, 0 if it is real.
Initial S/W Revision:	Prior to A.02.00
Modified at S/W Revision:	A.02.00
Help Map ID:	25718

:CALCulate:DATA:POINts commands

Returns the number of points that are returned by

CALCulate:<meas>:DATA<n>?

X axis scaling and whether All Frequency Points is on or off can affect this number.

NOTE For the CALCulate:<meas>:DATA<n>? XY command there are 2 numbers returned per data point.

Key Path:	SCPI Only
Mode:	VSA, LTE, LTETDD, IDEN
Measurement:	<meas>:=VECTor ADEMod DDEMod W11A W11B EVM IPOWER IDEMod MOTotalk
Remote Command:	:CALCulate:<meas>:DATA[1] 2 3 4:POINts? [OFF ON 0 1]
Example:	CALC:VECT:DATA1:POINts?
Notes:	<p>Query only.</p> <p>Use the optional "OFF 0" parameter to determine the number of points that are returned by the optional command form:</p> <p>:CALCulate:<meas>:DATA<n>? Y X XY,OFF 0</p> <p>Note that this is points, not array size. If the XY parameter is included, there are 2 numbers returned per point.</p> <p>(ON or 0, which means use the X-scaled version, is the default and the result is the same as if the parameter is omitted).</p>
Initial S/W Revision:	Prior to A.02.00
Modified at S/W Revision:	A.02.00
Help Map ID:	25719

This query returns the number of points that are returned by
 CALCulate:<meas>:DATA:RAW<n>?

NOTE For complex trace data, there are 2 numbers returned per data point.

Key Path:	SCPI Only
Mode:	VSA, LTE, LTETDD, IDEN
Measurement:	<meas>:=VECTor ADEMod DDEMod W11A W11B EVM IPOWER IDEMod MOTotalk
Remote Command:	:CALCulate:<meas>:DATA[1] 2 3 4:RAW:POINts?
Example:	CALC:VECT:DATA1:RAW:POINts?
Notes:	Query only.
Initial S/W Revision:	Prior to A.02.00
Modified at S/W Revision:	A.02.00

Help Map ID:	0
--------------	---

:CALCulate:DATA:TABL commands

Some traces have tabular data associated with them. In fact, there may be only a table and no trace data. Each entry in the table consists of a name, a measured value, and units. The units are sometimes not shown. You can programmatically retrieve arrays of all the names, all the values, and all the units of a table. These arrays are all ordered so that corresponding indices have associated values, for example, the 4th name in the names array corresponds to the 4th value in the results array. (Note that the array order cannot be the same as the displayed order.) You can also get a particular result from the table by name. Here is a summary of the remote table data commands.

Command	Returns	Example
CALCulate:<meas>:DATA<n>:TABL?	All table data results (as an array)	CALC:DDEM:DATA4:TABL?
CALCulate:<meas>:DATA<n>:TABL? "<name>"	The table data result referred to by name	CALC:DDEM:DATA4:TABL? "EvmPeak"
CALCulate:<meas>:DATA<n>:TABL:NAMEs?	Comma-separated list of all table data names	CALC:DDEM:DATA4:TABL:NAM?
CALCulate:<meas>:DATA<n>:TABL:UNIT?	Comma-separated list of all table data units	CALC:DDEM:DATA4:TABL:UNIT?

For example, if within the Vector Analysis measurement, you have an OBW Summary Table displayed in trace 2, CALC:DDEM:DATA2:TABL:NAM? would return the table names as follows:

"Obw,Pwr,TotalPwr,PwrRatio,ObwUpper,ObwLower,Centroid,Offset"

and CALC:DDEM:DATA2:TABL:UNIT? would return the units. (A null string means the result is unitless.)

"Hz,Vrms^2,Vrms^2,,Hz,HZ,HZ,HZ"

You can then get all the table results by sending

CALC:DDEM:DATA2:TABL?

Result number 1 is Obw and has units of Hz, result number 2 is Pwr with units of Vrms^2, and so on.

You can also get individual table entries by asking for them by name. Any name returned from the CALC:DDEM:DATA2:TABL:NAM? query can be used. For example, to get TotalPwr you can send the following query:

CALC:DDEM:DATA2:TABL? "TotalPwr"

Query Table Data as Number

Gets data from a table shown in the designated trace. Tables shown on the display typically have the name of a parameter followed by its measured value

Key Path:	SCPI Only
Mode:	VSA, LTE, LTETDD, IDEN
Measurement:	<meas>:=VECTor ADEMod DDEMod W11A W11B EVM IPOWER IDEMod MOTotalk
Remote Command:	:CALCulate:<meas>:DATA[1] 2 3 4 :TABLE[:NUMBER] ? [<string>]
Example:	CALC:DDEM:DATA2:TABL? "Obw"
Notes:	Query only. If sent without a string specifier, this returns the entire table for the designated trace. If sent with a string specifier, returns a specific table entry in the designated trace. The string specifier must be delimited by single or double quotes. A list of valid strings can be obtained using CALC:<meas>:DATA:TABL:NAM? If an invalid string is sent, an error is generated. The returned results are in numeric format, under control of the FORMat[:TRACe][:DATA] command. For table data that is non-numeric, NaN is returned. To get the value of these data, use the CALC:<meas>:DATA2:TABL:STR? command.
Initial S/W Revision:	Prior to A.02.00
Modified at S/W Revision:	A.02.00
Help Map ID:	25720

Query Table Data as String

Some tables have string data. The above Trace Table Data query cannot return it and sends NaN in its place. Here is a form of Trace Table Data query that can return string data from tables.

Key Path:	SCPI Only
Mode:	VSA, LTE, LTETDD, IDEN
Measurement:	<meas>:=VECTor ADEMod DDEMod W11A W11B EVM IPOWER IDEMod MOTotalk
Remote Command:	:CALCulate:<meas>:DATA[1] 2 3 4 :TABLE:STRing? [<string>]
Example:	CALC:DDEM:DATA2:TABL:STR? "Obw"
Notes:	Query only. If sent without a string specifier, this returns the entire table for the designated trace in comma-separated format. If sent with a string specifier, returns a specific table entry in the designated trace. The string specifier must be delimited by single or double quotes. A list of valid strings can be obtained using CALC:<meas>:DATA:TABL:NAM? If an invalid string is sent, an error is generated.

Common Measurement Functions 2

Initial S/W Revision:	Prior to A.02.00
Modified at S/W Revision:	A.02.00
Help Map ID:	30182

Query Table Names

Returns a comma-separated list of names of the table data entries for the designated trace. Each of the names can be used (surrounded by quotes or double quotes) as a parameter in the Trace Table Data commands. The names appear in the same order as the corresponding data values returned by the CALC:<meas>:DATA<n>:TABL[:NUMB|STR]? query.

Key Path:	SCPI Only
Mode:	VSA, LTE, LTETDD, IDEN
Measurement:	<meas>:=VECTor ADEMod DDEMod W11A W11B EVM IPOWer IDEMod MOTotalk
Remote Command:	:CALCulate:<meas>:DATA [1] 2 3 4 :TABLe:NAMEs?
Example:	CALC:VECT:DATA1:TABL:NAM?
Notes:	Query only. This retrieves the names of the table entries for the designated trace. Each of these names can be used in the CALC:<meas>:DATA:TABL? '<name>' command to access a single table entry.
Initial S/W Revision:	Prior to A.02.00
Modified at S/W Revision:	A.02.00
Help Map ID:	30183

Query Table Units

Returns a comma-separated list of all the units for the table data entries for the designated trace. If a data result is unitless, an empty string appears in the list for that result. The units appear in the same order as the corresponding data values returned by the CALC:<meas>:DATA<n>:TABL[:NUMB|STR]? query.

Key Path:	SCPI Only
Mode:	VSA, LTE, LTETDD, IDEN
Measurement:	<meas>:=VECTor ADEMod DDEMod W11A W11B EVM IPOWer IDEMod MOTotalk
Remote Command:	:CALCulate:<meas>:DATA [1] 2 3 4 :TABLe:UNIT?
Example:	CALC:VECT:DATA1:TABL:UNIT?
Notes:	Query only. This retrieves a list of units for table entries for the designated trace. The units are given in the order that the entries are sent from the :CALC:<meas>:DATA:TABL? command.
Initial S/W Revision:	Prior to A.02.00

Modified at S/W Revision:	A.02.00
Help Map ID:	30184

The following table data is available in all measurements when the ACP function is turned on and the associated summary table is shown in a trace:

Result name	Displayed Unit	Remote Name	Remote Unit
Reference Bandwidth	Hz	RefBw	Hz
Reference Alpha		RefAlpha	
Reference Power	dBm	RefPwr	Vrms ²
Offset	Hz	Offset1, Offset2, Offset3, Offset4, Offset5	Hz
BW	Hz	Bw1, Bw2, Bw3, Bw4, Bw5	Hz
Alpha		Alpha1, Alpha2, Alpha3, Alpha4, Alpha5	
Lower Pwr	dBm	LowPwr1, LowPwr2, LowPwr3, LowPwr4, LowPwr5	Vrms ²
Lower ACPR	dB	LowRatio1, LowRatio2, LowRatio3, LowRatio4, LowRatio5	
Upper Pwr	dBm	HiPwr1, HiPwr2, HiPwr3, HiPwr4, HiPwr5	Vrms ²
Upper ACPR	dB	HiRatio1, HiRatio2, HiRatio3, HiRatio4, HiRatio5	
Max ACPR	dB	MaxRatio1, MaxRatio2, MaxRatio3, MaxRatio4, MaxRatio5	

The following table data is available in all measurements when the OBW function is turned on and the associated summary table is shown in a trace:

Result name	Displayed Unit	Remote Name	Remote Unit
Occupied Bandwidth	Hz	Obw	Hz
Power	dBm	Pwr	Vrms ²
Total Power	dBm	TotalPwr	Vrms ²
Power Ratio	%	PwrRatio	

Common Measurement Functions 2

Result name	Displayed Unit	Remote Name	Remote Unit
Upper Freq	Hz	ObwUpper	Hz
Lower Freq	Hz	ObwLower	Hz
Centroid Freq	Hz	Centroid	Hz
Offset Freq	Hz	Offset	Hz

:CALCulate:DATA:HEADer commands

Trace data also has meta-data associated with it, called headers, which is visible if you export trace data in text format. The headers have a name and a value that can be obtained from any trace by using the CALCulate:<meas>:DATA:HEADer commands described in this section.

The following Remote Commands are described in this section:

[“Query Header Names” on page 1906](#)

[“Query Header Type” on page 1906](#)

[“Query Header as String” on page 1907](#)

[“Query Numeric Header” on page 1907](#)

[“:CALC:CLIMits:FAIL?” on page 1908](#)

Query Header Names

Returns a comma-separated list of all the header names associated with the designated trace. Each of the names can be used (surrounded by quotes or double quotes) as a parameter in the other CALC:<meas>:DATA<n>:HEAD queries.

Key Path:	SCPI Only
Mode:	VSA, LTE, LTETDD, IDEN
Measurement:	<meas>:=VECTor ADEMod DDEMod W11A W11B EVM IPOWer IDEMod MOTotalk
Remote Command:	:CALCulate:<meas>:DATA [1] 2 3 4 :HEADer:NAMEs?
Example:	CALC:VECT:DATA1:HEAD:NAM?
Notes:	Query only. Returns a comma-separated list of header names.
Initial S/W Revision:	Prior to A.02.00
Modified at S/W Revision:	A.02.00
Help Map ID:	30185

Query Header Type

Returns whether the designated header on the designated trace can be queried as a number or by a string

only.

Key Path:	SCPI Only
Mode:	VSA, LTE, LTETDD, IDEN
Measurement:	<meas>:=VECTor ADEMod DDEMod W11A W11B EVM IPOWER IDEMod MOTotalk
Remote Command:	:CALCulate:<meas>:DATA[1] 2 3 4 :HEADer:TYPE? <string>
Example:	CALC:VECT:DATA1:HEAD:TYPE? 'XDelta'
Notes:	Query only. This retrieves the type of the named header for the designated trace. The name (delimited by single or double quotes) is one of the names returned by CALC:<meas>:DATA:HEAD:NAMES? If a valid header name is passed in, the return value from this query is either STR or NUMB. NONE is returned if there is no such header.
Initial S/W Revision:	Prior to A.02.00
Modified at S/W Revision:	A.02.00
Help Map ID:	30186

Query Header as String

Gets a header by name from the designated trace and returns its value as a string.

Key Path:	SCPI Only
Mode:	VSA, LTE, LTETDD, IDEN
Measurement:	<meas>:=VECTor ADEMod DDEMod W11A W11B EVM IPOWER IDEMod MOTotalk
Remote Command:	:CALCulate:<meas>:DATA[1] 2 3 4 :HEADer:STRing? <string>
Example:	CALC:VECT:DATA1:HEAD:STR? 'WindowType'
Notes:	Query only. This retrieves the named header for the designated trace. The name (delimited by single or double quotes) is one of the names returned by the CALC:<meas>:DATA:HEAD:NAMES? The return value is a string. If the requested header value is a numeric or if there is no such header, an empty string is returned.
Initial S/W Revision:	Prior to A.02.00
Modified at S/W Revision:	A.02.00
Help Map ID:	0

Query Numeric Header

Gets a numeric header by name from the designated trace and returns its value in a format determined by

Common Measurement Functions 2

the last FORM command.

Key Path:	SCPI Only
Mode:	VSA, LTE, LTETDD, IDEN
Measurement:	<meas>:=VECTor ADEMod DDEMod W11A W11B EVM IPOWer IDEMod MOTotalk
Remote Command:	:CALCulate:<meas>:DATA [1] 2 3 4 :HEADer [:NUMBer] ? <string>
Example:	CALC:VECT:DATA1:HEAD? 'XDelta'
Notes:	Query only. This retrieves the named header for the designated trace. This form of the HEAD? query is for headers whose type is NUMB (as determined by :CALC:<meas>:DATA:HEAD:TYPE?). The name parameter (delimited by single or double quotes) is one of the names returned by CALC:<meas>:DATA:HEAD:NAMes?. The format of the return data is determined by the FORMat[:TRACe][:DATA] command. If used to query a header whose type is STR or there is no such header, NaN (9.91e37) is returned
Initial S/W Revision:	Prior to A.02.00
Modified at S/W Revision:	A.02.00
Help Map ID:	0

:CALC:CLIMits:FAIL?

If one or more ACP or OBW limit tests are active, then the CALC:CLIMits:FAIL? command returns the aggregate pass or fail status.

IQ Data Transfers

Fast capture/transfer of a large amount of IQ data is supported over SCPI. To do this, first set up the desired measurement range, center frequency, span, triggering, and so on. Use a time length that is convenient for setting up the measurement. The time length for the captured data is set indirectly as shown below.

To perform the capture, a typical SCPI sequence is as follows:

```
FCAP:LENG <num_samples>
```

This command sets the length for the next capture in samples. The sample rate is proportional to the current span and can be determined by a SCPI query, for example, in the Vector measurement the query:

```
VECT:SWE:ISR?
```

returns the input sample rate. For the IQAnalyzer (Basic) mode, the sample rate SCPI query is defined as follows:

```
:SPEC:SRAT? (Complex spectrum measurement)
```

```
:WAV:SRAT? (Waveform measurement)
```

Multiply the time length desired for the captured data by this sample rate to get the number of samples needed.

INIT:FCAP

pauses the current measurement and starts capturing IQ data using the current setup and trigger conditions. (The instrument front panel display does not change nor show the captured data.)

To read the captured data via SCPI in blocks, set the read block size using the command:

FCAP:BLOC <num_points_per_read_block>

The maximum read block size is typically less than the total fast capture buffer size and can be determined by the query “FCAP:BLOC? MAX”. Now you can repeatedly use the following query to read out successive blocks of data:

FETC:FCAP?

The returned data is formatted according to the most recent :FORMat[:DATA] and :FORMat:BORDER commands. A read pointer that indicates the next sample to be transferred is advanced automatically following each FETC:FCAP? query. This pointer position can be read or manually set via the SCPI commands:

FCAP:POIN?

FCAP:POIN <read_pointer_position>

The fast capture data can be read as long as you use only the commands to set read block size and pointer position, or queries that return the state of the current measurement. The capture data is cleared by any command that changes the measurement state or initiates a new measurement, or via SCPI device clear or :ABORT commands.

Fast capture data word size can be set to either 32 bit or 64 bit via the FCAP:WLEN command. This enables you to trade off precision for total capture length.

Note: when the word size is 32 bit, points can only be retrieved on even sample number boundaries, that is, the pointer and block length should be even numbers. Therefore, when the word size is set to auto, it is recommended that the pointer and block size be only set to even numbers.

Fast Capture Length

Sets the length of the SCPI Fast Capture in samples (points). This is constrained to be an even number.

Query returns the most recent length setting.

Key Path:	SCPI Only
Mode:	VSA, BASIC
Remote Command:	[:SENSe] :FCAPture:LENGth <integer> [:SENSe] :FCAPture:LENGth?
Example:	FCAP:LENG 1000 FCAP:LENG?

Common Measurement Functions 2

Notes:	This is affected by the IF path currently used, which can in turn be affected by span. It is also affected by the internal Fast Capture Word Length. The current maximum fast capture length can be found by using the query: FCAP:LENG? MAX Changing the Capture Length after initiating a fast capture clears the capture memory in preparation for a new fast capture of a different length. No Front panel access; SCPI only
Preset:	1048576 Samples
Min:	2
Max:	536 870 908 Samples for internal 40 MHz and 140 MHz options with FCAP:WLEN BIT32
Initial S/W Revision:	A.04.00
Help Map ID:	0

Fast Capture Word Length

Enables choice of internal fast capture word length. Shorter word length enables twice the time length to be captured at the cost of quantization noise. Note that this does not affect the format of data returned by FETCH:FCAPture, only the internal representation.

Key Path:	SCPI Only
Mode:	VSA, BASIC
Remote Command:	[:SENSe] :FCAPture :WLENgth AUTO BIT32 BIT64 [:SENSe] :FCAPture :WLENgth?
Example:	FCAP:WLEN AUTO FCAP:WLEN?
Notes:	No Front panel access; SCPI only.
Preset:	AUTO
Initial S/W Revision:	A.04.00
Help Map ID:	0

Initiate Fast Capture

Waits for the sweep to trigger and then captures the fast capture data. Sweep is then set to pause. The amount of data captured is controlled by the Fast Capture Length command (FCAP:LENG).

Key Path:	SCPI Only
Mode:	VSA, BASIC
Remote Command:	:INITiate:FCAPture

Example:	INIT:FCAP
Notes:	Returns when the capture is complete.
Notes:	No Front panel access; SCPI only This command resets the Fast Capture Pointer to 0
Initial S/W Revision:	A.04.00
Help Map ID:	0

Fast Capture Block

Sets the block size for the Fast Capture transfer in samples (points). This is the number of points that are returned from the Capture buffer by the FETC:FCAP? command. This is constrained to be an even number.

Query returns most recent block size setting.

Key Path:	SCPI Only
Mode:	VSA, BASIC
Remote Command:	[:SENSe] :FCAPture:BLOCK <integer> [:SENSe] :FCAPture:BLOCK?
Example:	FCAP:BLOC 100 FCAP:BLOC?
Notes:	No Front panel access. SCPI only.
Preset:	1024 Samples
Min:	0
Max:	131072 or Fast Capture Length, whichever is smaller
Initial S/W Revision:	A.04.00
Help Map ID:	0

Fast Capture Pointer

Sets the pointer position for the Fast Capture transfer in samples (points). The pointer is incremented by the block size each time the fetch is performed. Preset value (0) is the first sample in the record. Thus repetitive fetches result in contiguous data without needing to increment the pointer over SCPI. This is constrained to be an even number. Query returns most recent pointer setting.

Key Path:	SCPI Only
Mode:	VSA, BASIC

Common Measurement Functions 2

Remote Command:	[:SENSe] :FCAPture:POINter <integer> [:SENSe] :FCAPture:POINter?
Example:	FCAP:POIN 100 FCAP:POIN?
Notes:	INIT:FCAP or FCAP:ABOR resets the pointer to 0. No front panel access; SCPI only.
Preset:	0 Samples
Min:	0
Max:	Must be less than the Fast Capture length
Initial S/W Revision:	A.04.00
Help Map ID:	0

Fetch Fast Capture

Transfers the block of data starting at the pointer. The number of samples transferred is set with the block size. The pointer is incremented by the block size after the fetch.

Key Path:	SCPI Only
Mode:	VSA, BASIC
Remote Command:	:FETCh:FCAPture?
Example:	FETC:FCAP?
Notes:	The returned data is formatted according to the most recent :FORMat[:DATA] and :FORMat:BORDER commands. If the read pointer position plus read block size exceeds the Fast Capture Length, only the data between the pointer and the end of the fast capture buffer are returned, and error –200 is reported. If Fetch is attempted before an INIT:FCAP or if the captured data is cleared by some other operation (e.g., REC), error –230 is reported and no data is returned. No front panel access; SCPI only.
Initial S/W Revision:	A.04.00
Help Map ID:	0

Input Sample Rate Query

Returns the complex sample rate in Hz for the current VXA measurement setup conditions. The sample rate can be used to convert between time and number of sample points when using the Fast Capture feature.

Sample rate depends on the settings for FREQ:SPAN and IFPath. You need to set these before making this query. Though the measurement name is specified in the query, you can only query the currently

configured measurement. That is, if you have sent CONF:VECT, the query ADEM:SWE:ISR? generates an error.

Key Path:	SCPI Only
Mode:	VSA
Measurement:	<meas>:=VECTor ADEMod DDEMod W11A W11B
Remote Command:	[:SENSE] :<meas>:SWEep:ISRRate?
Example:	VECT:SWE:ISR?
Notes:	Query returns the complex sample rate in Hz for the current VXA Vector measurement setup conditions. If the measurement in the query is not the active measurement, error -230 is reported and no data is returned. This query is SCPI only, no Front Panel softkey.
Preset:	Depends on the licensed IF path
Initial S/W Revision:	A.04.00
Help Map ID:	0

Parameter Update Enable

Refers only to measurements that use the VSA measurement engine. These are all the measurements in the Vector Signal Analyzer (VXA) Application and the EVM measurement in the LTE Applications.

When a measurement parameter is changed, the new value is used to update any dependent parameters and measurement results. This update process is normally done after every parameter change. This enables visual feedback during interactive GUI operation. However, with SCPI controlled measurements, typically a lot of parameter changes are done at once with the measurement stopped and then the measurement is run once and data retrieved. Here, is not necessary, and the accumulated update time for each parameter change can become significant. The Parameter Update Enable command enables you to postpone update while sending setup commands and then enable one update to occur just before the measurement.

For example, if you are programmatically setting up a complex LTE measurement, you could save some setup time by first sending EVM:PUPD:ENAB OFF, then sending the whole group of measurement setup commands. When you are done with the setup, send EVM:PUPD:ENAB:ON. This causes the measurement state to be updated with all dependencies resolved. After this, you can read back the parameters' actual values. As a convenience, starting or continuing a measurement (INITiate:REStart, INITiate:IMMEDIATE, INITiate:<meas> or INITiate:RESume) automatically sets <meas>:PUPD:ENAB to ON. So does CONFigure:<meas> or any of the reset and recall state commands.

This command should be used with caution.

It is only valid to turn <meas>:PUPD:ENAB OFF when <meas> is the currently active measurement and the measurement is paused (i.e., INIT:CONT is OFF).

If you try to set and then read back a parameter value while Parameter Update Enable is off, you are not guaranteed to get back the true value that is used in the measurement because no parameter limiting is

Common Measurement Functions 2

being done nor are any dependencies between parameters being resolved.

If you try to set coupled parameters independently when Parameter Update Enable is off, then when it is turned on, at most one of the parameter settings remain the same and the others change due to dependency resolution.

Key Path:	SCPI Only
Mode:	VSA, LTE, LTETDD, IDEN
Measurement:	<meas>:=VECTor ADEMod DDEMod W11A W11B EVM IPOWer IDEMod MOTotalk
Remote Command:	[:SENSE] :<meas>:PUPDate:ENABle OFF ON 0 1 [:SENSE] :<meas>:PUPDate:ENABle?
Example:	EVM:PUPD:ENAB OFF
Notes:	Commands that cause a measurement to run, that switch measurements, or that preset or recall measurement state, set Parameter Update state to ON. These include INIT:IMM, INIT:REST, INIT:RES, INIT:<meas>, and CONF:<meas>.
Preset:	1
State Saved:	No
Initial S/W Revision:	A.03.00
Help Map ID:	30227